

# 9



- 腳墊  
Plastic Foot
- 橡膠腳墊  
Rubber Foot
- 金框腳墊  
Gold Covering Foot
- 銀框腳墊  
Silver Covering Foot
- 矽橡膠墊圈/華司  
Rubber O-rings & Washers
- 泡棉  
Foam
- 功率晶體導熱矽膠片  
Transistor Thermal Conductive Pads



# 腳墊 PLASTIC FOOT

用途：插銷式，可快速將腳墊固定於機殼，不脫落。

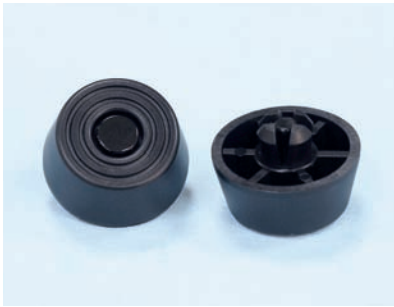

- Material: PE/TPR/TPV (UL)
- Flame Class: 94HB
- Pin Material: PP
- Color: Black/Gray/Computer
- Unit: mm

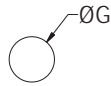
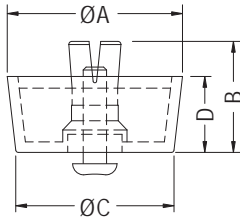

MOUNTING HOLE  
CHASSIS THICKNESS: T

Part No.	A	B	C	D	G	T	Package
FF-1	20.8	11.8	19.8	6.4	8.0	1.0~2.5	500
FF-2	20.0	15.4	18.0	10.0	8.0	1.0~2.5	
FF-3	23.7	19.2	19.5	13.7	8.0	1.0~2.5	250
FF-4	25.0	12.5	23.5	6.5	8.0	1.0~2.5	500
FF-5	30.0	18.8	27.7	12.8	8.0	1.0~2.5	200
FF-6	28.5	14.0	26.5	8.2	10.0	1.0~3.5	250
FF-7	12.7	8.5	12.0	4.4	5.0	1.0~2.0	1000
FF-8	15.7	8.5	15.0	4.4	5.0	1.0~2.0	
FF-9	20.0	7.0	18.6	4.0	8.0	1.0~2.0	500
FF-10	23.8	10.0	22.0	5.0	8.0	1.0~2.5	
FF-11	31.5	13.6	28.5	7.8	10.0	1.0~3.5	250
FF-12	20.0	20.8	18.0	15.0	8.0	1.0~3.0	
FF-13	20.0	24.3	18.0	18.0	8.0	0.8~1.0	500
FF-14	19.5	10.5	18.7	5.0	8.0	0.8~2.0	500
FF-16	29.4	23.0	26.5	15.0	10.0	1.0~3.5	100
FF-19	20.0	9.1	18.0	6.0	4.0	0.8	1000
FF-20	20.0	8.4	18.0	5.2	5.0	0.8	
FF-21	20.0	25.6	19.3	20.5	8.0	0.8~2.0	250
FF-22	19.2	12.1	17.2	7.9	8.0	0.8~1.2	500
FF-24	23.0	13.3	21.0	8.0	8.0	0.8~2.0	
FF-25	24.0	15.8	20.0	10.5	8.0	0.8~2.0	250
FF-26	22.0	10.5	21.0	3.5	8.0	1.0~3.0	500
FF-27	26.7	21.0	24.8	16.0	8.0	1.0~3.0	200
FF-28	20.0	13.5	18.0	10.0	8.0	0.8~2.0	250
FF-31	27.0	12.0	26.0	6.9	10.0	0.8~2.0	
FF-34	41.2	21.6	40.0	14.0	10.0	0.8~2.0	100
FF-35	14.0	10.6	12.7	5.8	6.0	1.0~2.5	1000
FF-36	22.0	10.5	20.0	3.5	8.0	1.0~3.0	500
FF-41	20.8	12.6	19.8	7.2	8.0	1.0~2.5	
FF-43	12.0	10.0	10.5	5.8	5.0	1.0~2.5	1000
FF-44	20.8	11.8	19.8	6.9	8.0	1.0~2.5	500
FF-51	20.0	17.8	18.0	14.0	5.0	1.6	
FF-58	25.0	10.5	23.0	5.0	8.0	0.8~1.5	250



- Body Material: TPV
- Pin Material: PP
- Color: Black
- Unit: mm

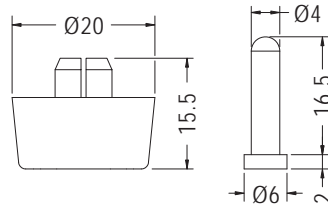

BODY

PIN

MOUNTING HOLE Ø8.0~Ø8.1  
PANEL THICKNESS 0.8~1.5

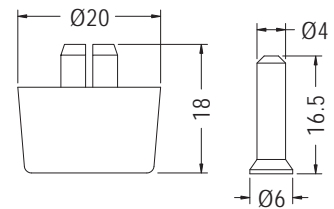

BODY

PIN

MOUNTING HOLE Ø8.0~Ø8.1  
PANEL THICKNESS 0.5~1.2

Part No.	Part No.	Package
FF-56	FF-56A	1000
	FF-56B	

Part No.	Part No.	Package
FF-57	FF-57A	1000
	FF-57B	

# 腳墊 PLASTIC FOOT

用途：插銷式，可快速將腳墊固定於機殼，不脫落，耐重壓。



- Foot Material: TPE
- Pin Material: Nylon 66 (UL) 94V-2
- Color: Black
- Unit: mm

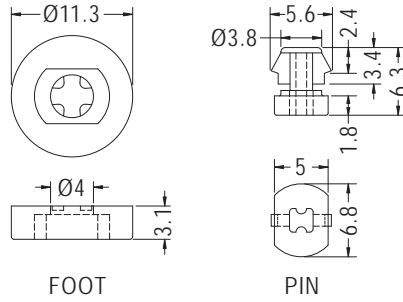

CHASSIS Ø4.0  
THICKNESS 0.8-1.0

Part No.	Part No.	Package
FF-15	FF-15A FF-15B	1000



- Foot Material: TPE
- Rivet Material: Nylon 66 (UL) 94V-2
- Color: Black
- Unit: mm

用途：插銷式，可快速將腳墊固定於機殼，不脫落。

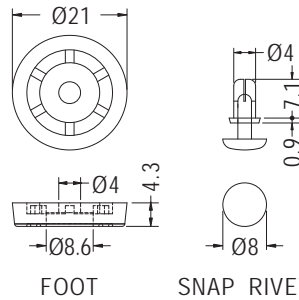

MOUNTING HOLE Ø4.0  
THICKNESS 2.5

Part No.	Part No.	Package
FF-40F	FF-40A SR4-7	1000



- Foot Material: TPR
- Rivet Material: Nylon 66 (UL) 94V-2
- Color: Black
- Unit: mm

用途：插銷式，可快速將腳墊固定於機殼，不脫落，可更換鉚釘配合不同板厚。

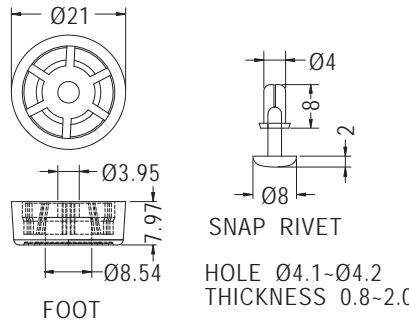

HOLE Ø4.1-Ø4.2  
THICKNESS 0.8-2.0

Part No.	Part No.	Package
FF-46F	FF-46A SR4-71	1000

- Foot Material: TPV

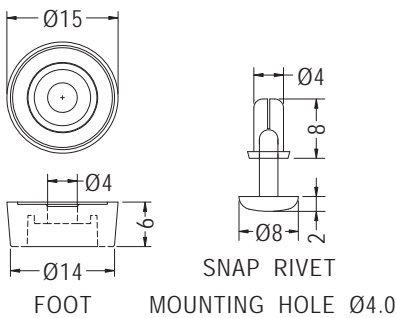

MOUNTING HOLE Ø4.0

Part No.	Part No.	Package
FF-47F	FF-47A SR4-7	1000

- Foot Material: TPE
- Rivet Material: Nylon 66 (UL)
- Flame Class: 94V-2/94V-0
- Color: Black
- Unit: mm

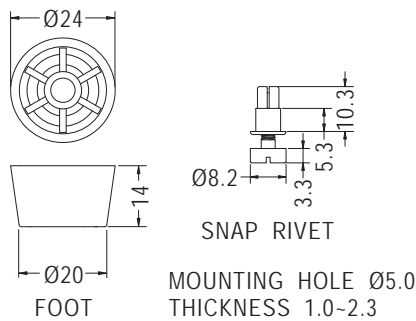

MOUNTING HOLE Ø5.0  
THICKNESS 1.0-2.3

Part No.	Part No.	Package
FF-52F	FF-52A SRMB-1	1000

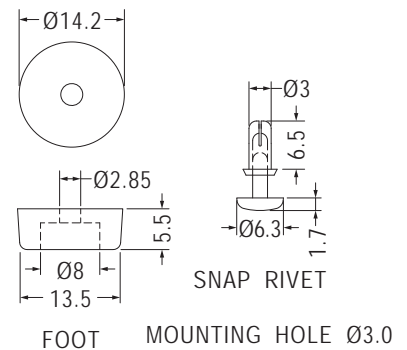

MOUNTING HOLE Ø3.0

Part No.	Part No.	Package
FF-55F	FF-55A SR3-5.5	1000

# 腳墊 PLASTIC FOOT



- Foot Material: TPV (UL)
- Rivet Material: Nylon 66 (UL)
- Flame Class: 94HB/94V-2/94V-0
- Color: Black
- Unit: mm

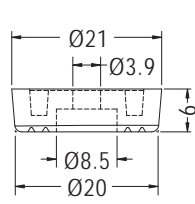

FOOT

MOUNTING HOLE Ø4.1~Ø4.2  
THICKNESS 0.8~1.8

Part No.	Part No.	Package
FF-59F	FF-59A SR4-6	1000

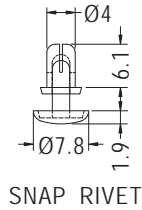

SNAP RIVET

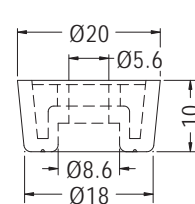

FOOT

MOUNTING HOLE Ø5.0  
THICKNESS 1.0~2.3

Part No.	Part No.	Package
FF-60F	FF-60A SRMB-1	1000

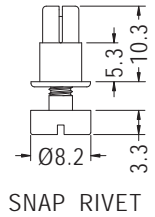

SNAP RIVET

用途：插銷式，可快速將腳墊固定於機殼，不脫落，可更換鉚釘配合不同板厚。

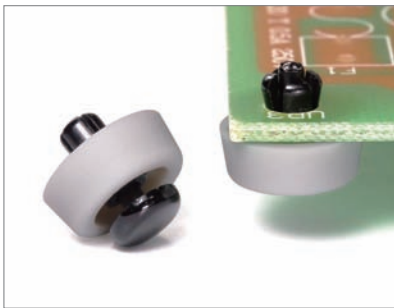

- Foot Material: TPE (UL)
- Rivet Material: Nylon 66 (UL)
- Flame Class: 94HB/94V-2
- Foot Color: Gray
- Rivet Color: Black
- Unit: mm

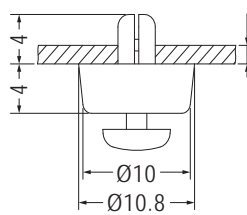

MOUNTING HOLE Ø3.6

用途：插銷式，可快速將腳墊固定於機殼，不脫落。

THICKNESS 1.5~2.2



Part No.	Part No.	Package
FF-62F	FF-62A SR3.5-6	1000



- Material: TPE
- Color: Black
- Unit: mm

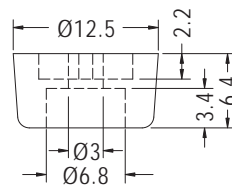

用途：可快速將腳墊固定於機殼，不脫落。

Part No.	Package
FF-37	1000



- Material: ABS/PP
- Color: Black
- Unit: mm

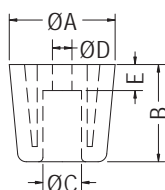

用途：機械外殼之座墊，使用螺絲固定，安全不脫落，耐重壓。

Part No.	A	B	C	D	E	Package
FFT-1	15.0	8.0	7.5	3.7	3.5	1000
FFT-2	20.0	12.1	8.2	4.1	5.5	500
FFT-3	25.1	16.2	10.4	4.3	8.1	100
FFT-4	24.4	22.4	8.9	4.6	6.0	
FFT-5	26.0	12.7	10.9	5.1	5.7	
FFT-6	22.5	22.4	8.6	4.6	6.0	
FFT-7	17.0	17.0	7.5	3.2	6.0	500
FFT-8	19.8	20.0	9.5	4.2	5.7	
FFT-9	20.0	12.8	9.5	3.6	5.7	
FFT-10	20.0	10.5	9.2	4.4	4.0	
FFT-11	28.5	8.2	11.29	7.1	6.0	100

# 腳墊 PLASTIC FOOT

用途：機械外殼之座墊，使用螺絲固定，安全不脫落，耐重壓。

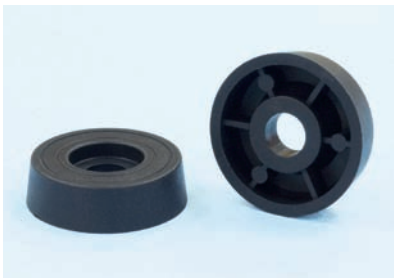

- Material: TPR
- Color: Black
- Unit: mm

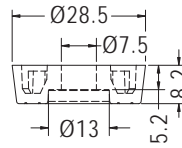

Part No.	Package
FFT-15	200



- Color: Black
- Unit: mm

用途：機械外殼之座墊，使用螺絲固定，安全不脫落。

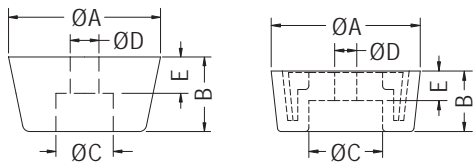

【 NF-001, NF-006, NF-007, NF-008, NF-008A, NF-014 】

Part No.	A	B	C	D	E	Material	Package
NF-001	14.8	7.0	6.0	3.0	3.1	PE	1000
NF-002	11.5	7.4	5.6	3.2	3.3	Rubber	
NF-004	16.0	7.8	6.0	3.0	3.5	Rubber	
NF-005	17.2	7.0	9.0	4.0	3.0	Rubber	500
NF-006	20.2	8.0	10.0	3.0	4.0	PE	
NF-007	25.0	5.8	8.5	3.3	2.8	PE	
NF-007I	25.0	5.8	8.5	3.3	3.0	Silicon Rubber	1000
NF-008	20.0	10.5	9.8	3.0	5.0	PE	
NF-008A	20.0	10.5	9.8	4.0	5.0	PE	
NF-009	11.0	5.7	6.0	3.5	2.3	PE/PP	100
NF-013	18.0	9.8	7.8	3.5	2.7	PP	
NF-014	28.0	20.0	9.7	3.8	6.0	PE/PP	
NF-018	28.0	25.0	9.7	4.2	6.0	Rubber	100
NF-020	20.2	15.0	9.4	3.5	4.0	Rubber	
NF-046	22.0	14.0	9.5	4.0	6.5	Rubber	

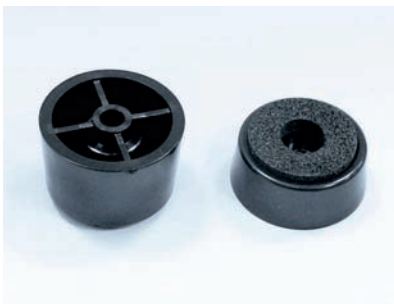

- Material: ABS
- Color: Black
- Unit: mm

用途：螺絲式，將腳墊固定於機殼，下有泡棉或矽膠，抗滑性佳。

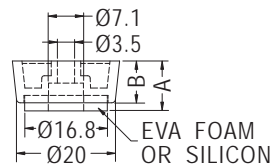
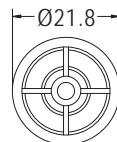

Part No.	A	B	Package
FFS-1	10.0	8.5	500
FFS-2	15.0	13.5	

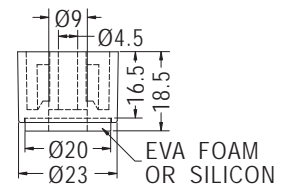

Part No.	Package
FFS-5	500



- Housing Material: TPR
- Color: Black
- Unit: mm

用途：機械外殼之座墊，使用螺絲固定，安全不脫落，耐重壓。

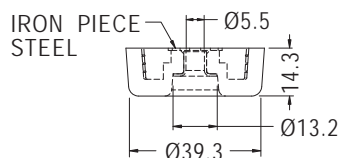
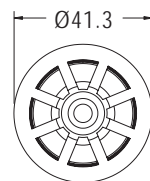

Part No.	Package
FFR-1	50

## 腳墊 PLASTIC FOOT



- Material: TPE
- Color: Black
- Unit: mm

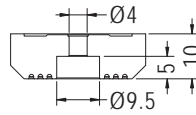
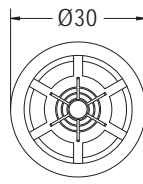

Part No.	Package
FFP-30	250

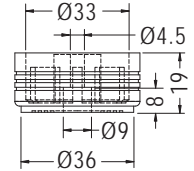
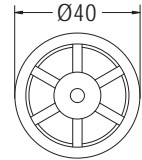

Part No.	Package
FFP-40	50

用途：機械外殼之座墊，使用螺絲固定，安全不脫落，耐重壓。

## 橡膠腳墊 RUBBER FOOT



- Material: Rubber
- Color: Black
- Unit: mm

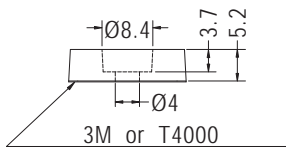
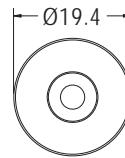

3M or T4000  
DOUBLE ADHESIVE TAPE  
高度尺寸不含背膠

Part No.	Package
TF-605	1000

用途：用於機器、電子儀器之腳墊，可自黏或螺絲固定兩用。

## 抗震腳墊 ANTI-VIBRATION FOOT

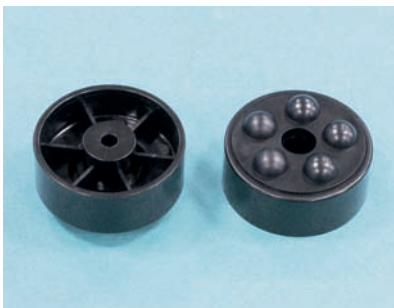

- Body Material: ABS
- Pad Material: TPE
- Color: Black
- Unit: mm

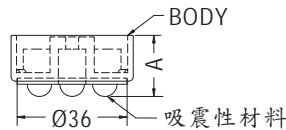
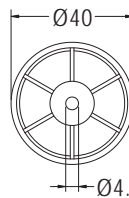

BODY  
吸震性材料  
Shock Absorbing Materials.

Part No.	A	Package
FFQ-1	20.0	500
FFQ-2	12.0	

用途：特殊吸震材料，用於需抗震之重低音音響、影碟機等之防震腳墊，裝配容易、美觀防震性佳。

## 腳墊 PLASTIC FOOT



- Housing Material: ABS (UL)
- Housing Flame Class: 94HB
- Color: Black
- Unit: mm

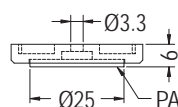
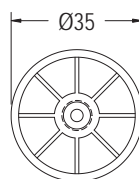

Part No.
FFK-5(RU)

用途：用於音響、影碟機等之腳墊，裝配容易、美觀。

## 腳墊 PLASTIC FOOT

用途：用於音響、影碟機等之腳墊，裝配容易、美觀。



- Housing Material: ABS
- Color: Black
- Unit: mm

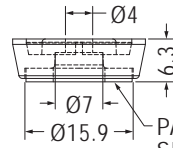
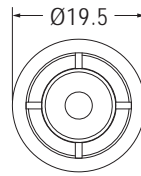

PAD MATERIAL:  
SILICON RUBBER

Part No.
FFK-6I



- Housing Material: ABS
- Color: Black
- Unit: mm
- FFK Series: Without Silver/Gold Covering

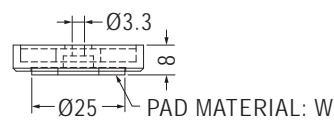
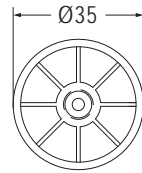

PAD MATERIAL: W

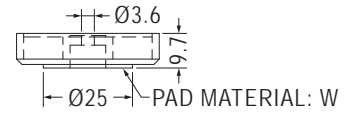
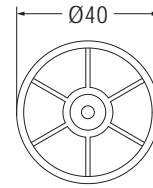

PAD MATERIAL: W

- FFK-4P: 外部霧面處理
- FFK-4P: Matte finished surface

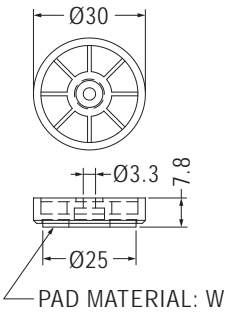

PAD MATERIAL: W

Part No.	W
FFK-1	EVA
FFK-1P	Poron
FFK-1(RU)	Rubber

Part No.	W
FFK-3	EVA
FFK-3P	Poron
FFK-3(RU)	Rubber

Part No.	W
FFK-2	EVA
FFK-2P	Poron
FFK-2(RU)	Rubber
FFK-4P	Poron

## 銀框腳墊 SILVER COVERING FOOT

用途：用於音響、影碟機等之腳墊，裝配容易、美觀。



- Housing Material: ABS
- Color: Black
- Unit: mm

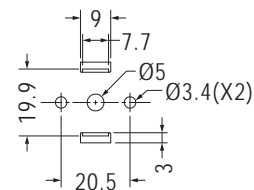
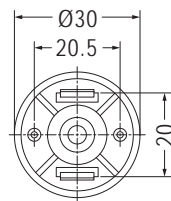

MOUNTING HOLE

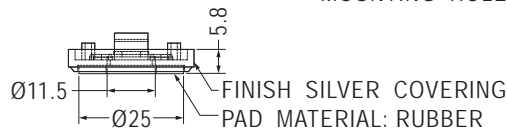

FINISH SILVER COVERING  
PAD MATERIAL: RUBBER

Part No.
FFH-30S(RU)

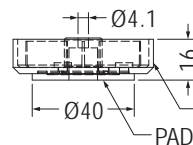
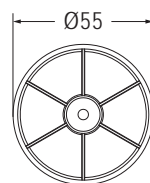

FINISH: F  
PAD MATERIAL: TPE

Part No.	F
RS-61N	
RS-61S	Silver Covering

## 銀框腳墊 SILVER COVERING FOOT



- Housing Material: ABS (UL)
- Flame Class: 94HB
- Color: Black
- Unit: mm

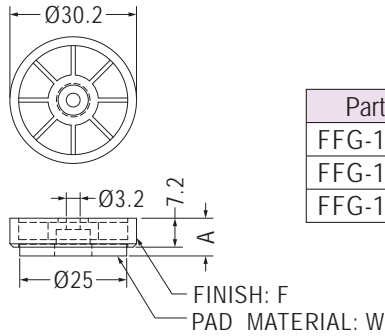

Part No.	A	F	W
FFG-1A	9.1	Silver Covering	EVA
FFG-1A(N)	9.1		EVA
FFG-1A(RU)	8.2	Silver Covering	Rubber

## 金框腳墊 GOLD COVERING FOOT



- Housing Material: ABS
- Color: Black
- Unit: mm

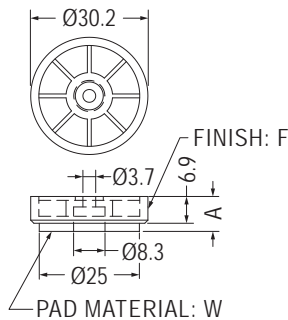

用途：用於音響、影碟機等之腳墊，裝配容易、美觀。

Part No.	A	F	W
FFG-1	9.0	Silver Covering	EVA
FFG-1(RU)	8.0	Silver Covering	Rubber
FFG-1G(RU)	8.0	Gold Covering	Rubber
FFG-1N		Silver Covering	

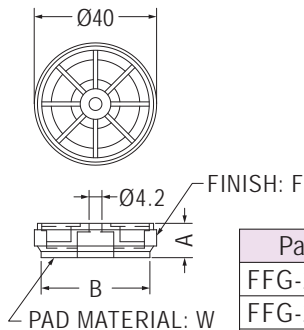

Part No.	A	B	F	W
FFG-2A	10.8	35.5	Gold Covering	EVA
FFG-2A(RU)	10.2	35.5	Gold Covering	Rubber
FFG-2A(S)	11.0	35.0	Silver Covering	EVA
FFG-2AS(RU)	10.2	35.5	Silver Covering	Rubber

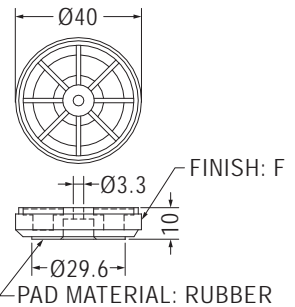

Part No.	F
FFG-2	Gold Covering
FFG-2(S)	Silver Covering

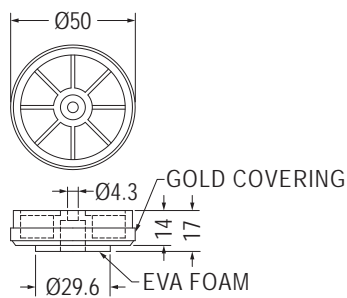

Part No.
FFG-3

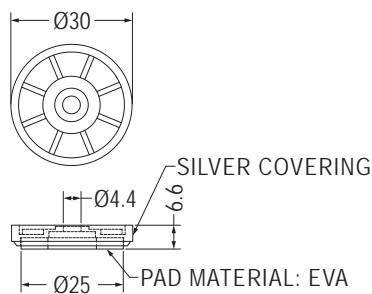

Part No.
FFG-30(S)

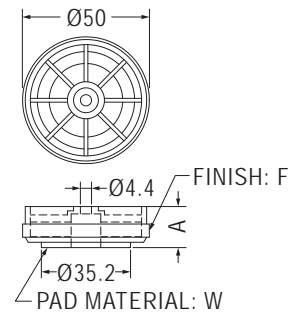

Part No.	A	F	W
FFG-3A	16.2	Gold Covering	EVA
FFG-3A(RU)	15.4	Gold Covering	Rubber
FFG-3A(S)	16.0	Silver Covering	EVA
FFG-3A(G)N		Gold Covering	
FFG-3AN	16.2		EVA
FFG-3AN(RU)	15.4		Rubber



# 金框腳墊 GOLD COVERING FOOT

用途：用於音響、影碟機等之腳墊，裝配容易、美觀。

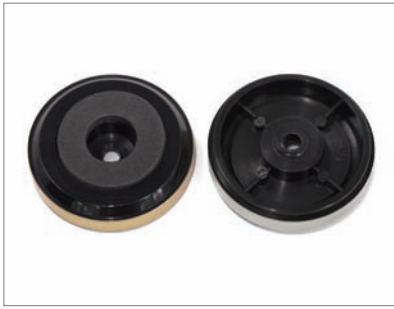

- Housing Material: ABS
- Color: Black
- Unit: mm

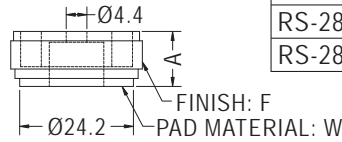
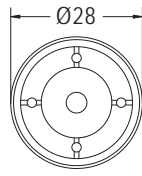

Part No.	A	F	W
RS-28	11.7	Golden Alum. Covering	EVA
RS-28(S)	11.7	Silver Alum. Covering	EVA
RS-28S(RU)	10.7	Silver Alum. Covering	Rubber
RS-28N(RU)	10.7		Rubber
RS-28(N)N	10.0		

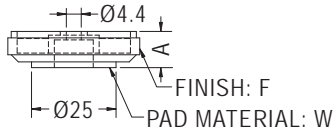
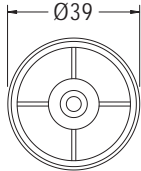

Part No.	A	F	W
RS-40	10.7	Golden Alum. Covering	EVA
RS-40(S)	10.7	Silver Alum. Covering	EVA
RS-40S(RU)	9.8	Silver Alum. Covering	Rubber

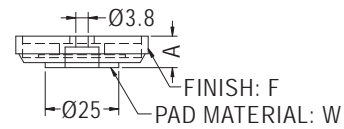
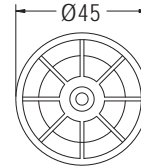

Part No.	A	F	W
RS-45	10.7	Golden Alum. Covering	EVA
RS-45(S)	10.7	Silver Alum. Covering	EVA
RS-45(RU)	9.7	Golden Alum. Covering	Rubber
RS-45S(RU)	9.7	Silver Alum. Covering	Rubber
RS-45(S)I	9.7	Silver Alum. Covering	Silicon Rubber

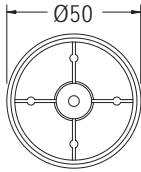

Part No.	A	F	W
RS-50	14.8	Gold Covering	EVA
RS-50(RU)	14.0	Gold Covering	Rubber
RS-50N	14.8		EVA
RS-50N(RU)	14.0		Rubber
RS-50(S)	14.8	Silver Covering	EVA
RS-50S(RU)	14.0	Silver Covering	Rubber

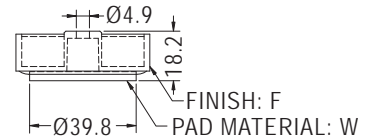
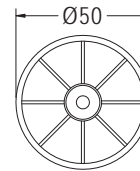

Part No.	F	W
RS-50-2	Golden Alum. Covering	EVA

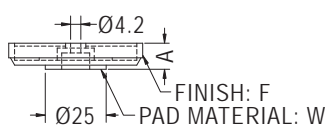
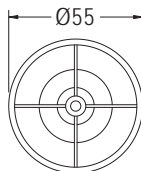

Part No.	A	F	W
RS-55	10.7	Golden Alum. Covering	EVA
RS-55(S)	10.7	Silver Alum. Covering	EVA
RS-55S(RU)	9.7	Silver Alum. Covering	Rubber

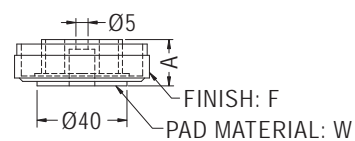
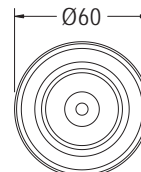

Part No.	A	F	W
RS-60N	20.0		EVA
RS-60	20.0	Golden Alum. Covering	EVA
RS-60(BK)	20.0	鍍黑灰色 Dark Gray Covering	EVA
RS-60(S)	20.0	Silver Alum. Covering	EVA
RS-60(S)RU	19.3	Silver Alum. Covering	Rubber

# 金框腳墊 GOLD COVERING FOOT

用途：用於音響、錄影機等之腳墊，裝配容易、美觀。

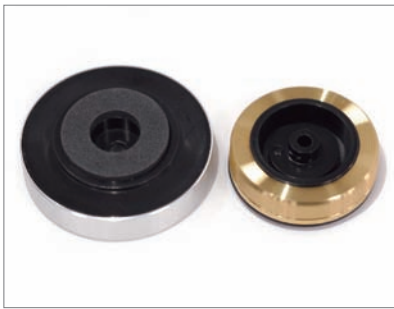

- Housing Material: ABS
- Metal Material: AL
- Color: Black
- Unit: mm

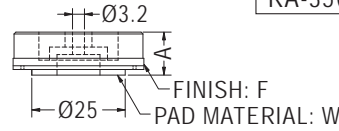
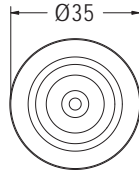

Part No.	A	F	W
RA-35	11.5	Golden Alum. Covering	EVA
RA-35(S)	11.5	Silver Alum. Covering	EVA
RA-35(S)RU	10.5	Silver Alum. Covering	Rubber

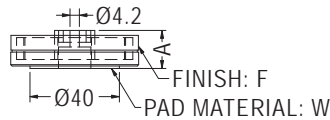
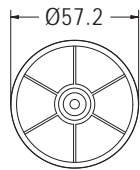

Part No.	A	F	W
RA-57	17.0	Golden Alum. Covering	EVA
RA-57(RU)	17.1	Golden Alum. Covering	Rubber
RA-57(S)	17.0	Silver Alum. Covering	EVA
RA-57S(RU)	17.1	Silver Alum. Covering	Rubber

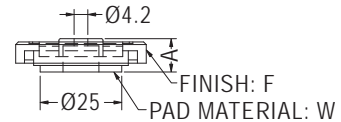
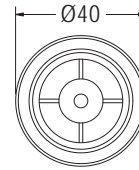

Part No.	A	F	W
RA-40	12.0	Golden Alum. Covering	EVA
RA-40(RU)	11.0	Golden Alum. Covering	Rubber
RA-40(S)	12.0	Silver Alum. Covering	EVA
RA-40S(RU)	11.0	Silver Alum. Covering	Rubber
RA-40(K)	12.0	Champagne Color	EVA

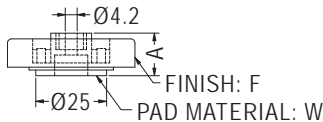
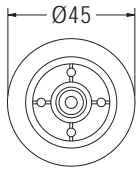

Part No.	A	F	W
RA-45	15.0	Golden Alum. Covering	EVA
RA-45(S)	15.0	Silver Alum. Covering	EVA
RA-45(RUS)	14.0	Silver Alum. Covering	Rubber
RA-45S(RU)	14.1	Silver Alum. Covering	Rubber
RA-45S(I)	14.1	Silver Alum. Covering	Silicon Rubber

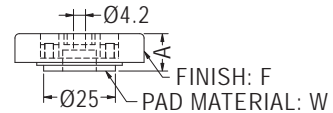
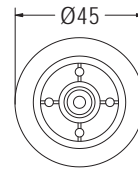

Part No.	A	F	W
RA-45S-1	12.5	Silver Alum. Covering	EVA
RA-45-1(RU)	11.5	Golden Alum. Covering	Rubber
RA-45S-1(RU)	11.5	Silver Alum. Covering	Rubber

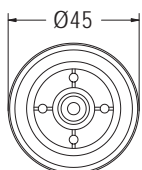

Part No.  
RA-45S-3

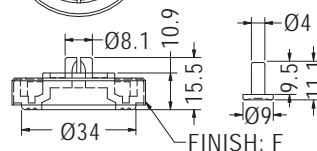
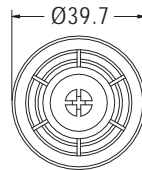

MOUNTING HOLE Ø8.0

- Foot Material: PE
- Pin Material: PP

Part No.	F
RAFF-40	Golden Alum. Covering
RAFF-40(S)	Silver Alum. Covering
RAFF-40(B)	Black Alum. Covering

## 橡膠腳墊 RUBBER FOOT

用途：可快速將腳墊固定於機殼，裝配容易，不脫落。



- Material: Rubber
- Color: Black
- Unit: mm

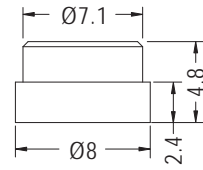

MOUNTING HOLE Ø7.0

Part No.	Package
TF-017	1000



- Material: Rubber
- Color: Black
- Unit: mm

用途：用於機殼之座墊，裝配容易安全不脫落。

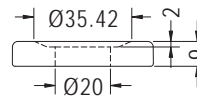
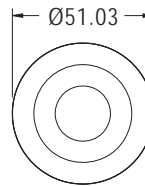

Part No.	Package
TF-448	500

## 矽膠腳墊 SILICON RUBBER FOOT

用途：可快速將腳墊固定於機殼，裝配容易，不脫落。



- Material: Silicon Rubber
- Color: Black
- Unit: mm

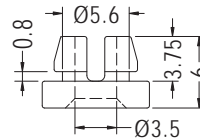

Part No.	Package
TF-561	1000

## 腳墊 PLASTIC FOOT

用途：固定於機殼，保護用。



- Material: TPR
- Color: Black
- Unit: mm

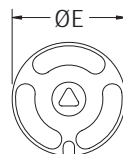

HOLE IN CHASSIS

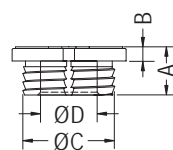

Part No.	A	B	C	D	E	G	Package
TFF-1	9.0	3.0	16.3	10.0	20.0	16.0	1000
TFF-2	8.5	2.5	16.3	10.0	20.0	16.0	
TFF-3	9.0	2.4	20.2	13.5	22.8	19.8	
TFF-5	7.5	2.5	16.3	10.0	20.0	16.0	

# 腳墊 PLASTIC FOOT

用途：可快速將腳墊固定於機殼，裝配容易，不脫落。



- Material: TPR
- Color: Black
- Unit: mm

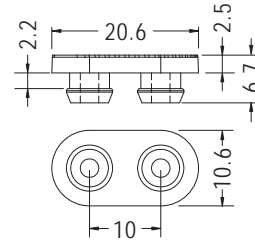

MOUNTING HOLE Ø5.6  
THICKNESS 2.0

Part No.	Package
TNFF-1	1000

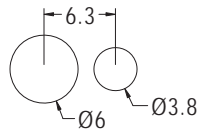
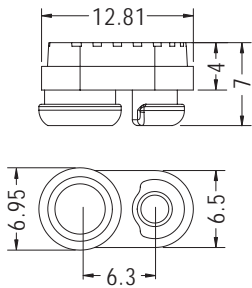

MOUNTING HOLE Ø5.6  
CHASSIS THICKNESS 1.0-1.2

Part No.	Package
TNFF-2	1000

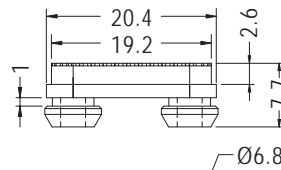

MOUNTING HOLE Ø5.0

Part No.	Package
TNFF-3	1000

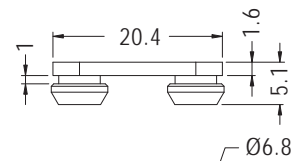

MOUNTING HOLE Ø5.0

Part No.	Package
TNFF-4	1000



- Material: Silicon Rubber (UL)
- Flame Class: 94HB/94V-0
- Color: Black
- Unit: mm

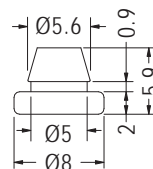

MOUNTING HOLE Ø4.5-Ø5.0

Part No.	Package
TNF-7	2000

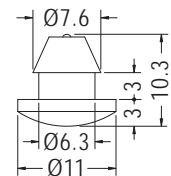

MOUNTING HOLE Ø6.3

Part No.	Package
TNF-44	2000

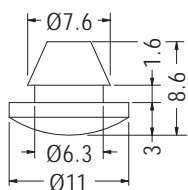

MOUNTING HOLE Ø6.5

- Material: Rubber

Part No.	Package
TNF-6	2000

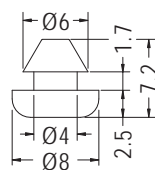

MOUNTING HOLE Ø4.2

Part No.	Package
TNF-5	1000

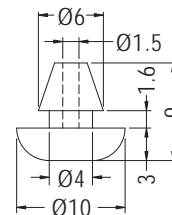

MOUNTING HOLE Ø4.0

- Material: Neoprene

Part No.	Package
TNF-41	1000

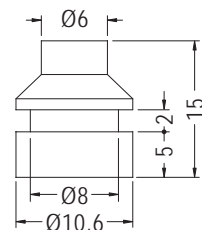

MOUNTING HOLE Ø8.2

Part No.	Package
TNF-2	1000

# 腳墊 PLASTIC FOOT

用途：可快速將腳墊固定於機殼，裝配容易，不脫落。



- Material: Rubber
- Color: Black
- Unit: mm

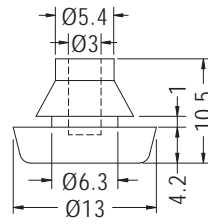

MOUNTING HOLE Ø6.35

Part No.	Package
TNF-3	1000

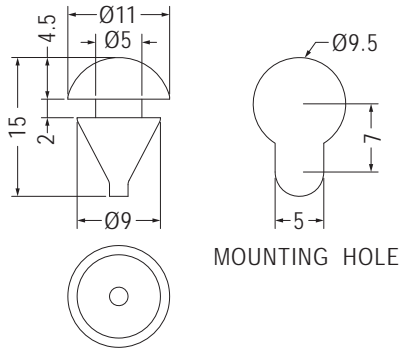

MOUNTING HOLE

- Material: TPE
- Color: White

Part No.	Package
TNF-40	1000

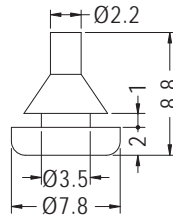

MOUNTING HOLE Ø3.5

- Material: EPDM

Part No.	Package
TF-546	1000

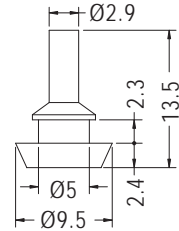

MOUNTING HOLE Ø5.2

Part No.	Package
TNF-1	1000

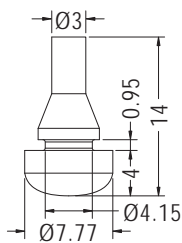

MOUNTING HOLE Ø4.2

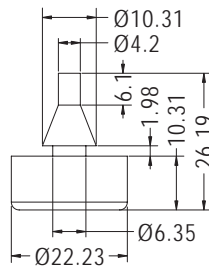

MOUNTING HOLE Ø8.0  
THICKNESS 2.0

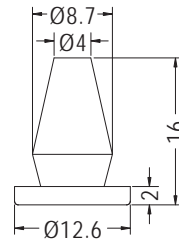

MOUNTING HOLE Ø7.0

- Material: Silicon Rubber

Part No.	Package
TF-041	1000

- Material: Neoprene

Part No.	Package
TNF-15	500

Part No.	Package
TNF-47	1000

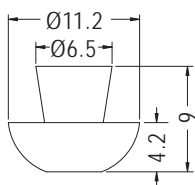

MOUNTING HOLE Ø5.0

Part No.	Package
TNF-46	1000

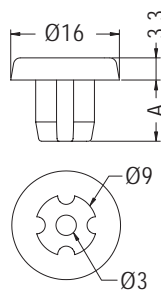

MOUNTING HOLE Ø8.3-Ø8.5

Part No.	A	Package
TNF-9	9.0	2000
TNF-19	6.5	

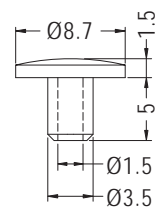

MOUNTING HOLE Ø3.5

Part No.	Package
TF-283	1000

## 腳墊 PLASTIC FOOT



- Material: TPE
- Color: Black
- Unit: mm

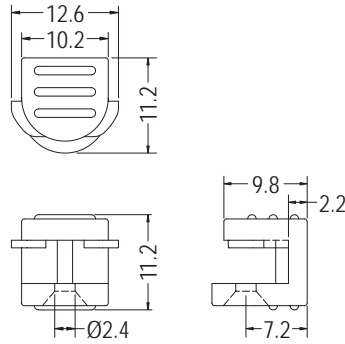

Part No.	Package
DELT-21	1000

用途：可快速將腳墊固定於機殼，裝配容易，不脫落。

## 橡膠腳墊 RUBBER FOOT



- Material: Rubber
- Color: Black
- Unit: mm

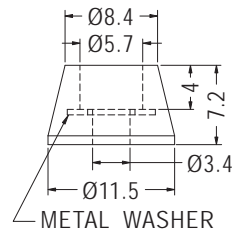

Part No.	Package
NF-002ST	1000

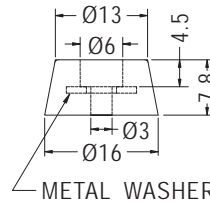

Part No.	Package
NF-004ST	1000

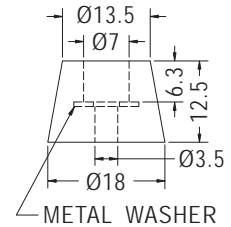

Part No.	Package
NF-039ST	1000

用途：機械外殼之座墊，內含有鐵華司，使用螺絲固定，安全不脫落，耐重壓。

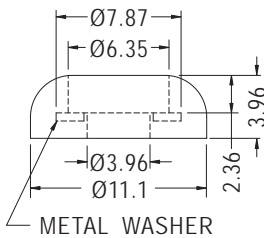

Part No.	Package
NF-011ST	1000

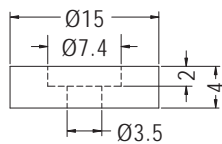

Part No.	Package
NF-012	1000

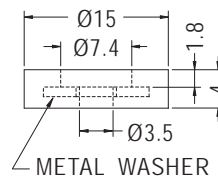

Part No.	Package
NF-012ST	1000

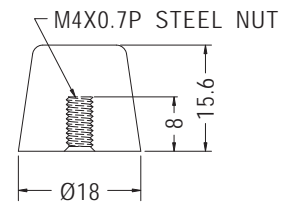

Part No.	Package
NF-051ST	1000

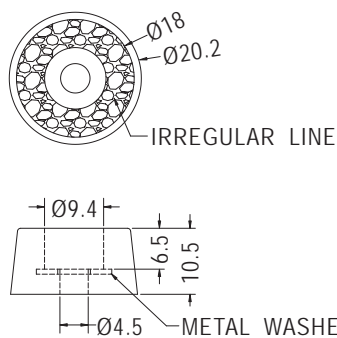

Part No.	Package
NF-015ST	1000

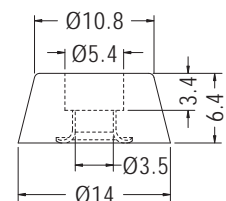

- Metal Ring Material: Bronze

Part No.	Package
NF-016ST	1000

## 橡膠腳墊 RUBBER FOOT



- Material: Silicon Rubber (UL)/Rubber
- Flame Class: 94HB
- Color: Black
- Unit: mm

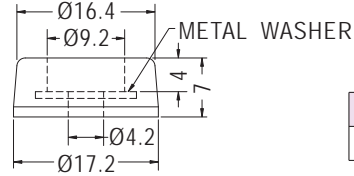

Part No.	Package
NF-005ST	1000

用途：機械外殼之座墊，內含有鐵華司，使用螺絲固定，安全不脫落，耐重壓。

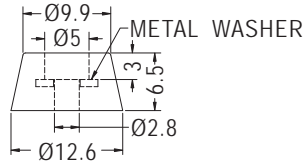

Part No.	Package
NF-030IST	1000

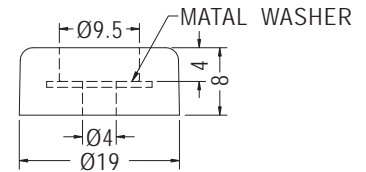

Part No.	Package
NF-047ST	1000

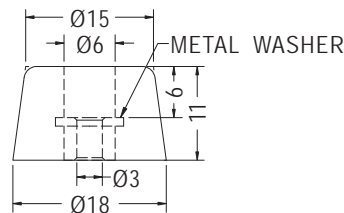

Part No.	Package
NF-035IST	1000

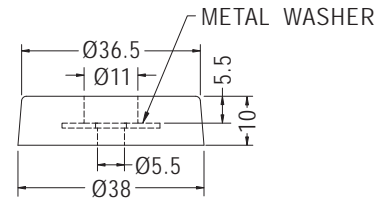

- Material: Rubber

Part No.	Package
NF-050ST	250

## 腳墊 PLASTIC FOOT



- Material: TPE
- Color: Black
- Unit: mm

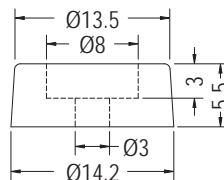

Part No.	Package
NF-031	1000

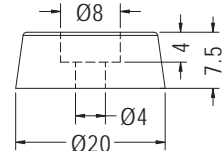

- Material: Rubber

Part No.	Package
NF-045	1000

用途：機械外殼之座墊，使用螺絲固定，安全不脫落，耐重壓。

## 磁鐵腳墊 MAGNET PLASTIC FOOT



- Foot Material: Nylon 66 (UL)
- Magnet Material: NdFeB
- Flame Class: 94V-2/94V-0
- Color: Natural/Black
- Unit: mm

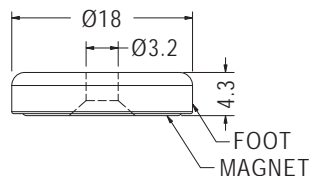

Part No.	Package
MGFA-2	1000

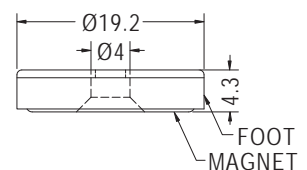

- Foot Material: Steel

Part No.	Package
MGFF-4	1000

用途：磁鐵腳墊，可將HUB吸著於鐵板上。

## 腳墊 PLASTIC FOOT



- Material: PE
- Color: Black
- Unit: mm

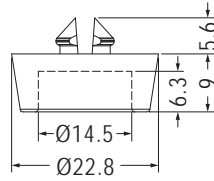

MOUNTING HOLE Ø8.0

用途：用於機殼之座墊，裝配容易、安全不脫落。

Part No.	Package
GL-4	500

## 矽膠腳墊 SILICON RUBBER FOOT



- Material: Silicon Rubber
- Body Material: Nylon 66 (UL)94V-2
- Color: Gray
- Body Color: Black
- Unit: mm

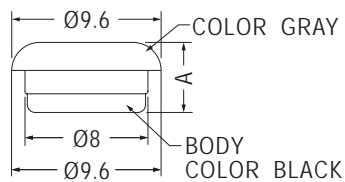

用途：做為腳墊止滑用。

Part No.	A	Package
FFDA-9AY	4.5	2000
FFDA-10AY	4.55	

## 腳墊 PLASTIC FOOT

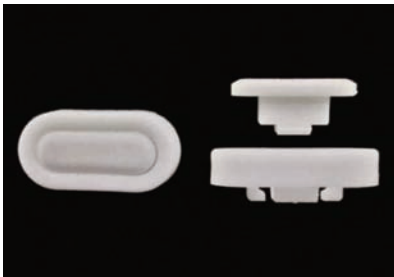

- Body Material: TPR
- Pin Material: ABS (UL) 94HB
- Color: Black/White
- Unit: mm

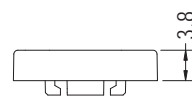
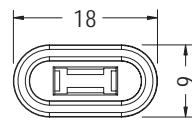

BODY

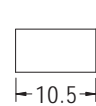

MOUNTING HOLE THICKNESS 0.8

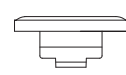
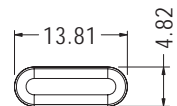

PIN

Part No.	Package
ASFF-1A	1000

Part No.	Package
ASFF-1B	1000

用途：電腦外殼之座墊，使用插銷固定，安全不脫落。



- Material: TPR
- Metal Ring Material: SPCC
- Color: Gray
- Unit: mm

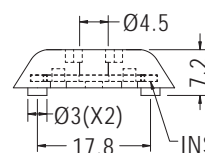
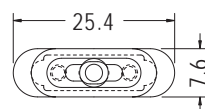

INSERT IRON PIECE

用途：機械外殼之座墊，內含有鐵件，使用螺絲固定，安全不脫落，耐重壓。

Part No.	Package
TF-356	1000



# 橡膠腳墊 RUBBER FOOT

用途：背膠式，可快速將腳墊固定於機殼，黏性佳、不脫落。



- Material: Rubber
- Color: Black
- Unit: mm

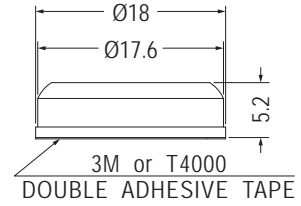
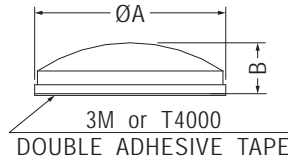

Part No.	A	B
RF-004	9.9	3.8
RF14-5A	14.0	5.0
RF27-7AC-1	27.8	7.4

Part No.
RF18-5A



- Material: Rubber/Silicon Rubber
- Color: Black
- Unit: mm

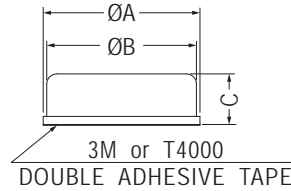

Part No.	A	B	C
RF5.8-4A	5.8	5.5	4.0
RF8-3.5	8.0	7.7	3.5
RF8.2-5	8.2	7.6	5.0
RF9-3.5	9.0	8.2	3.5
RF9.7-4.2A	9.7	9.3	4.2
RF15.5-5A	15.4	14.8	5.1
RF19-4A7	19.05	18.05	4.06
RF22.8-5	22.8	22.4	5.0
RF22-8.8	22.0	21.0	8.8
RF22-5	22.0	21.0	5.0



- Material: Rubber/Silicon Rubber
- Color: Black
- Unit: mm
- Other Materials Available: EPDM

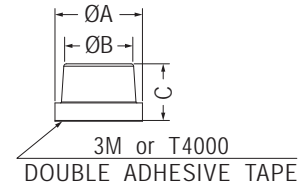
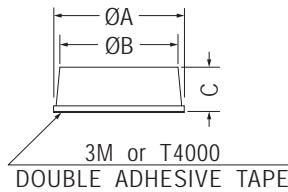

【 RF7-4.2A, RF8-6.5A, RF10-6.2A, RF12.7-6.2A, RF15-13.5A, RF17-11A 】

Part No.	A	B	C
RF6-5	6.0	5.0	5.0
RF7-4.2A	7.0	6.5	4.2
RF7-3.2A	7.0	6.6	3.2
RF8-6.5A	8.0	7.2	6.5
★RF10-6.2A	10.0	7.5	6.2
RF-1094A	10.0	9.0	9.4
RF-003	10.0	9.5	4.2
RF-030	10.0	9.5	8.0
RF-1055	10.0	9.7	5.5
RF-009	10.8	10.2	3.0
RF11-5	11.0	9.6	5.0
RF-011	11.0	10.5	5.0
RF11-3.2A	11.3	10.7	3.2
RF-039	11.9	11.2	6.4
RF12-27A	12.0	11.6	2.7

Part No.	A	B	C
RF-015	12.0	11.2	5.1
RF-019	12.0	9.5	4.0
RF-019A	12.7	10.0	3.8
RF12.7-6.2A	12.7	10.0	6.2
RF-032	12.7	11.5	4.0
RF-005	13.0	11.4	5.0
RF-012	13.0	12.2	4.5
RF15-11A	15.0	13.5	11.0
★RF15-13.5A	15.0	13.5	13.5
RF17-11A	17.0	13.25	11.0
RF-007	19.0	17.0	7.2
RF-020	19.0	15.8	4.2
RF20-5	19.8	18.0	5.0
RF-008	20.0	19.0	6.0
RF24-8	24.0	20.0	8.0

## 橡膠腳墊 RUBBER FOOT

用途：背膠式，可快速將腳墊固定於機殼，黏性佳、不脫落。



- Material: Rubber/Silicon Rubber
- Color: Black
- Unit: mm
- Other Materials Available: EPDM

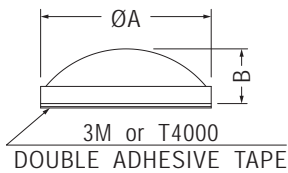

Part No.	A	B
RF-002	10.0	2.8
RF8-2A	8.0	2.0
RF8-2.6A	8.0	2.6
RF8-3A	8.0	3.0
RF8.8-2.9A	8.8	2.89
RF21.6-11A	21.6	11.0

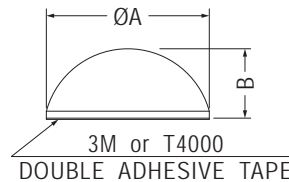

Part No.	A	B
RF-021	6.7	4.2
RF7.8-2.9A	7.8	2.9
RF9.5-3.9A	9.5	3.9
RF-1106	11.0	6.0
RF-022	11.3	5.6
RF14-8A	14.0	8.0
RF-006	15.9	8.0
RF21-8.5	21.6	8.52
RF21-10	21.6	10.0



- Material: Rubber
- Color: Black
- Unit: mm

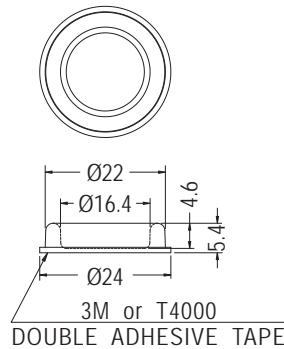

Part No.
RF-031

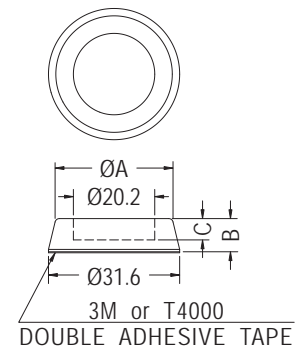

Part No.	A	B	C
RF-016	29.6	6.6	4.1
RF-017	29.0	8.8	4.9

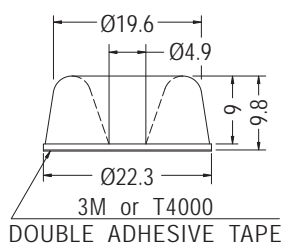

Part No.
RF-018

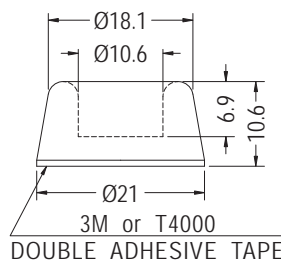

Part No.
RF20-10

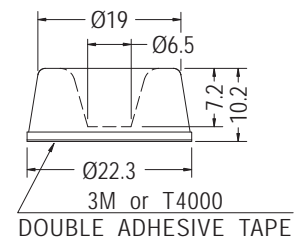

Part No.
RF-029

## 橡膠華司 RUBBER WASHER

用途：做為零件之墊片。



- Material: Rubber
- Color: Black
- Unit: mm

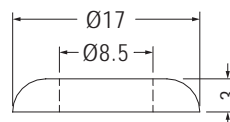

Part No.
RWF8.5-3N

## 橡膠華司 RUBBER WASHER

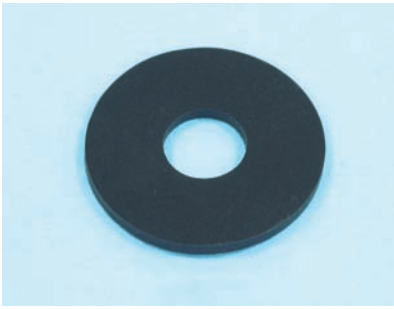

- Material: Rubber/Silicon Rubber
- Color: Black
- Unit: mm

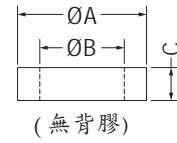
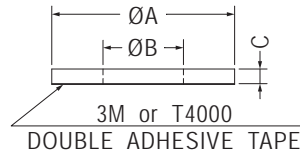

【 RWF7.6-1.7N, RWF7.2-2.8N 】

Part No.	A	B	C
RWF3.5-0.5	8.0	3.5	0.5
RWF3.5-1	8.0	3.5	1.0
RWF4.5-2	8.0	4.5	2.0
★RWF7.6-1.7N	10.9	7.6	1.7
RWF3.5-1.5	11.0	3.5	1.5
★RWF7.2-2.8N	11.0	7.2	2.8

Part No.	A	B	C
RWF4.5-3	15.0	4.5	3.0
RWF18-8.5-15	18.0	8.5	1.5
RWF20-1.5	20.0	6.0	1.5
RWF25-2	25.0	11.0	2.0
RWF10.2-2	29.6	10.2	2.0
RWF40-2	40.0	12.0	2.0
RWF43-2	43.0	30.1	2.0

## 橡膠墊圈 O-RING



- Material: NBR/EPDM/Silicon Rubber
- Color: Black
- Unit: mm

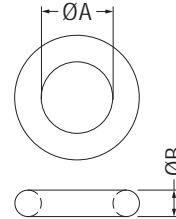

用途：做為零件之油封或墊片。

Part No.	A	B	Package
OR-1.7	1.7	0.6	2000
OR-2	2.0	1.0	
OR-2.7	2.75	0.6	
OR-2.8	2.8	0.5	
OR-2.9	2.9	1.78	
OR-3.6	3.6	1.78	
OR-4	4.0	2.0	
OR-4.6	4.6	1.78	
OR-5	5.0	1.0	
OR5.5-11.8	5.5	3.15	
OR-5.8	5.8	1.9	

Part No.	A	B	Package
OR-6	6.02	2.6	2000
OR6.07-1.63	6.07	1.63	
OR7-2	7.0	2.0	
OR-7.6	7.65	1.78	
OR-7.9	7.9	1.0	
OR-11	11.0	2.0	
OR-88	20.0	1.0	
OR-21.3	21.3	3.0	
OR-25.2	25.2	3.5	
OR-84.4	84.4	3.1	

## 矽膠墊圈 O-RING



- Material: Silicon Rubber
- Color: Black
- Unit: mm

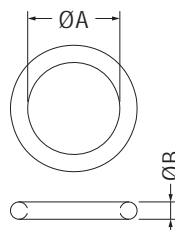

用途：做為零件之油封或墊片。

Part No.	A	B	Package
OR2.4-1.9	2.4	1.9	2000
OR2.6-1.1	2.6	1.1	
OR8-1.5	8.0	1.5	
OR10.5-1	10.5	1.0	
OR10.6-1.25	10.6	1.25	
OR15-1.5	15.0	1.5	
OR-31-1.8	31.47	1.78	

# 橡膠腳墊 RUBBER FOOT

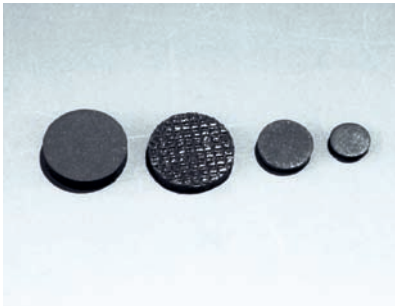

- Material: Rubber/Silicon Rubber
- Color: Black
- Unit: mm
- Other Materials Available:  
EPDM, Poron
- Optional Thickness: 0.5-3.2mm

用途：背膠式，可快速將腳墊固定於機殼，黏性佳、不脫落。

可依客戶指定長、寬、高裁切成各種形狀，如方形、圓形。表面可分為平面、斜紋等。

Different size available per request.

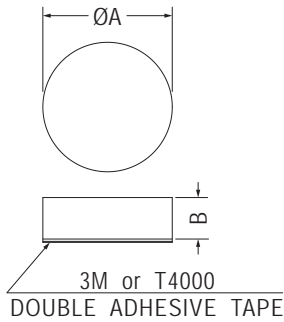

Part No.	A	B
RF3.8-2	3.8	2.0
RF0415	4.0	1.5
RF4-0.5	4.0	0.5
RF4-0.6	4.0	0.6
RF4-3	4.0	3.0
RF4.5-1.5	4.5	1.5
RF4.5-2.7	4.5	2.7
RF4.8-1	4.8	1.0
RF5-1.5	5.0	1.5
RF5-2	5.0	2.0
RF5-2.5	5.0	2.5
RF5-3.5	5.0	3.5
RF5.3-0.7	5.3	0.7
RF5.5-1.6	5.5	1.6
RF5.6-2	5.6	2.0
RF6-0.5	6.0	0.5
RF6-0.8	6.0	0.8
RF6-0.9	6.0	0.9
RF6-1	6.0	1.0
RF6-1.3	6.0	1.3
RF6-1.5	6.0	1.5
RF6-2	6.0	2.0
RF6-2.5	6.0	2.5
RF6-3	6.0	3.0
RF6-3.5	6.0	3.5
RF6.4-2.6	6.4	2.6
RF6.5-1	6.5	1.0
RF6.5-2.5	6.5	2.5
RF6.6-1.5	6.6	1.5
RF6.6-1.8	6.6	1.8
RF6.6-2	6.6	2.0
RF7-0.5	7.0	0.5
RF7-0.9	7.0	0.9
RF7-1	7.0	1.0
RF7-1.5	7.0	1.5
RF7-2	7.0	2.0
RF7-2.5	7.0	2.5
RF7-2.7	7.0	2.7
RF7-3	7.0	3.0
RF7.2-1.5	7.2	1.5
RF7.5-2	7.5	2.0

Part No.	A	B
RF-001	8.0	1.8
RF8-0.5	8.0	0.5
RF8-1	8.0	1.0
RF8-1.4	8.0	1.4
RF8-1.5	8.0	1.5
RF8-2	8.0	2.0
RF8-2.5	8.0	2.5
RF8-3	8.0	3.0
RF8.5-1.5	8.5	1.5
RF8.5-2	8.5	2.0
RF9-1	9.0	1.0
RF9-1.2	9.0	1.2
RF9-1.5	9.0	1.5
RF9-2	9.0	2.0
RF9-2.5	9.0	2.5
RF9-3	9.0	3.0
RF9.5-0.8	9.5	0.8
RF9.5-1.5	9.5	1.5
RF9.5-1.8	9.5	1.8
RF9.5-2	9.5	2.0
RF9.5-3	9.5	3.0
RF10-0.8	10.0	0.8
RF10-1	10.0	1.0
RF10-1.3	10.0	1.3
RF-1016	10.0	1.6
RF-1018	10.0	1.8
RF10-2	10.0	2.0
RF10-3	10.0	3.0
RF10.5-1	10.5	1.0
RF10.5-15	10.5	1.5
RF10.5-2	10.5	2.0
RF-11632	11.6	3.2
RF12-1.5	12.0	1.5
RF-1210	12.0	1.0
RF12-2.7	12.0	2.7
RF-1220	12.0	2.0
RF12-3	12.0	3.0
RF12-3.6	12.0	3.6
RF-1232	12.0	3.2
RF-12520	12.5	2.0
RF12.5-1	12.5	1.0

Part No.	A	B
RF12732	12.7	3.2
RF13-1	13.0	1.0
RF13-3	13.0	3.0
RF14-4	14.0	4.0
RF14530	14.5	3.0
RF14.5-4	14.5	4.0
RF-1463	14.6	3.0
RF-1510	15.0	1.0
RF-1520	15.0	2.0
RF-1530	15.0	3.0
RF16.5-3	16.5	3.0
RF18-1.3	18.0	1.3
RF18-1.5	18.0	1.5
RF18-2.5	18.0	2.5
RF19-1	19.0	1.0
RF19-2	19.0	2.0
RF19-3	19.0	3.0
RF19-4	19.0	4.0
RF-19823	19.8	2.3
RF20-1	20.0	1.0
RF20-1.5	20.0	1.5
RF20-1.8	20.0	1.8
RF-2023	20.0	2.3
RF-2025	20.0	2.5
RF-2030	20.0	3.0
RF22-2	22.0	2.0
RF22-2.5	22.0	2.5
RF22.1-10.4	21.7	10.4
RF24.6-3	24.6	3.0
RF25-2.3	25.0	2.3
RF27-3	27.0	3.0
RF28-3.2	28.0	3.2
RF30-2	30.0	2.0
RF40-1	40.0	1.0
RF58-1.5	58.0	1.5
RF58-2	58.0	2.0
RF64.7-2.5S	64.7	2.5

# 橡膠腳墊 RUBBER FOOT

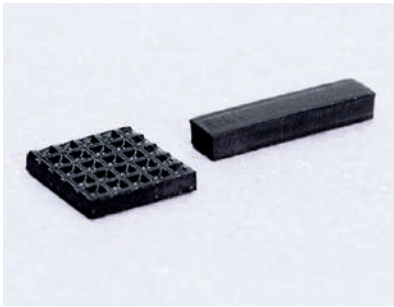

- Material: Rubber/Silicon Rubber
- Color: Black
- Unit: mm
- Other Materials Available: EPDM, Poron
- Optional Thickness: 0.5-10mm

用途：背膠式，可快速將腳墊固定於機殼，黏性佳、不脫落。

可依客戶指定長、寬、高裁切成各種形狀，如方形、圓形。表面可分為平面、斜紋等。

Different size available per request.

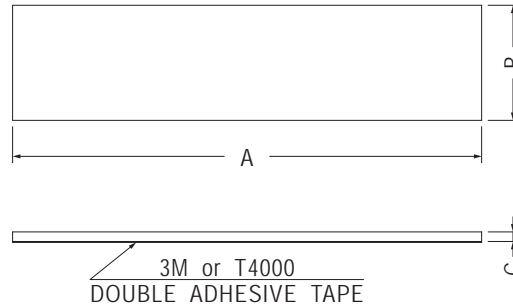

Part No.	A	B	C
SF050435	5.0	4.5	3.5
SF062313	6.0	2.3	1.3
SF060425	6.0	4.0	2.5
SF652840	6.5	2.8	4.0
SF652850	6.5	2.8	5.0
SF070215	7.0	2.0	1.5
SF070216	7.0	2.0	1.6
SF070304	7.0	3.0	0.4
SF073512	7.0	3.5	1.2
SF070420	7.0	4.0	2.0
SF070620	7.0	6.0	2.0
SF080625	8.0	6.0	2.5
SF852530	8.5	2.5	3.0
SF853520	8.5	3.5	2.0
SF853525	8.5	3.5	2.5
SF80452	8.0	4.5	2.0
SF090855	9.6	8.0	5.5
SF100616	9.9	6.0	1.6
SF100119	10.0	1.9	1.9
SF103512	10.0	3.5	1.2
SF100409	10.0	4.0	0.9
SF100510	10.0	5.0	1.0
SF100520	10.0	5.0	2.0
SF100712	10.0	7.0	1.2
SF100825	10.0	8.0	2.5
SF100850	10.0	8.0	5.0
SF100730	10.5	7.2	3.0
SF110830	11.5	8.0	3.0
SF118781	11.8	7.8	1.0
SF120565	12.0	5.0	6.5
SF120810	12.0	8.5	1.0
SF129515	12.0	9.5	1.5
SF121530	12.0	15.0	3.0
SF1256535	12.5	6.5	3.5
SF1251008	12.5	10.0	0.8
SF-1251015	12.5	10.0	1.5
SF130620	13.0	6.0	2.0
SF130630	13.0	6.0	3.0
SF130735	13.0	7.0	3.5
SF130740	13.0	7.0	4.0
SF130855	13.5	8.0	5.5
SF132525	13.0	2.5	2.5

Part No.	A	B	C
SF140430	14.0	4.0	3.0
SF140440	14.0	4.0	4.0
SF150320	15.0	3.2	2.0
SF150610	15.0	6.0	1.0
SF151016	15.0	10.0	1.6
SF151930	15.0	1.9	3.0
SF152530	15.0	25.0	3.0
SF155030	15.0	50.0	3.0
SF1585601	15.8	5.6	1.0
SF151025	15.8	10.0	2.5
SF-163530	16.0	3.5	3.0
SF160536	16.0	5.0	3.6
SF170525	17.0	5.0	2.5
SF1724330	17.2	4.3	3.0
SF180930	18.0	9.0	3.0
SF181010	18.0	10.0	1.0
SF181020	18.0	10.0	2.0
SF195640	19.0	5.6	4.0
SF195720	19.0	5.7	2.0
SF-197774	19.7	7.7	4.0
SF197760	19.7	7.7	6.0
SF190814	19.7	8.0	1.4
SF190815	19.7	8.0	1.5
SF-1979723	19.7	9.7	2.3
SF1979725	19.7	9.7	2.5
SF-1979730	19.7	9.7	3.0
SF-1972015	19.7	20.0	1.5
SF202515	20.0	2.5	1.5
SF200410	20.0	4.0	1.0
SF200420	20.0	4.0	2.0
SF200510	20.0	5.0	1.0
SF200515	20.0	5.0	1.5
SF200563	20.0	5.0	6.3
SF200568	20.0	5.0	6.8
SF200725	20.0	7.0	2.5
SF201010	20.0	10.0	1.0
SF201015	20.0	10.0	1.5
SF201020	20.0	10.0	2.0
SF201035	20.0	10.0	3.5
SF201056	20.0	10.0	5.6
SF201465	20.0	14.0	6.5
SF201515	20.0	15.0	1.5

Part No.	A	B	C
SF200612	20.5	6.0	1.2
SF210804	21.5	8.6	0.4
SF-221615	22.0	16.0	1.5
SF227640	22.6	7.6	4.0
SF237640	23.0	7.6	4.0
SF230610	23.7	6.5	1.0
SF246011	24.8	6.0	1.1
SF250535	25.0	5.0	3.5
SF250550	25.0	5.0	5.0
SF250760	25.0	7.0	6.0
SF250810	25.0	8.0	1.0
SF250815	25.0	8.0	1.5
SF250820	25.0	8.0	2.0
SF251235	25.0	12.0	3.5
SF251224	25.4	12.7	2.4
SF251232	25.4	12.7	3.2
SF260510	26.8	5.5	1.0
SF270830	27.0	8.0	3.0
SF271810	27.0	18.0	1.0
SF271820	27.0	18.0	2.0
SF27183	27.0	18.0	3.0
SF279032	27.5	9.0	3.2
SF-3064	30.0	6.0	4.0
SF303555	30.0	3.5	5.5
SF-30709	30.0	7.0	0.9
SF3038	30.0	8.0	3.8
SF-301120	30.0	11.0	2.0
SF-301140	30.0	11.0	4.0
SF301230	30.0	12.0	3.0
SF301250	30.0	12.0	5.0
SF301525	30.0	15.0	2.5
SF302055	30.0	20.0	5.5
SF302501	30.0	25.0	1.0
SF30511	30.5	11.0	7.0
SF311510	31.5	15.5	1.0
SF311515	31.5	15.5	1.5
SF3267225	32.0	6.7	2.25
SF321720	32.0	17.0	2.0
SF321725	32.0	17.0	2.5
SF332055	33.0	20.0	5.5
SF332385	33.3	23.3	8.5
SF331125	33.5	11.5	2.5

# 橡膠腳墊 RUBBER FOOT

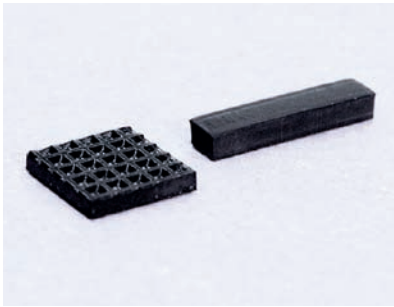

- Material: Rubber/Silicon Rubber
- Color: Black
- Unit: mm
- Other Materials Available: EPDM, Poron
- Optional Thickness: 0.5-10mm

用途：背膠式，可快速將腳墊固定於機殼，黏性佳、不脫落。

可依客戶指定長、寬、高裁切成各種形狀，如方形、圓形。表面可分為平面、斜紋等。

Different size available per request.

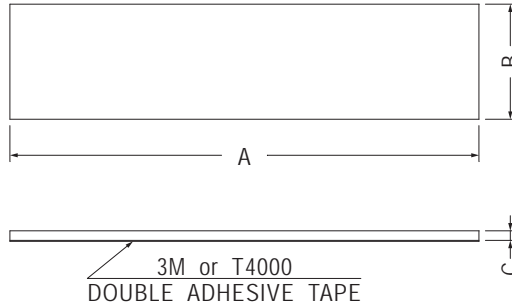

Part No.	A	B	C
SF340220	34.0	2.0	2.0
SF340904	34.6	9.5	0.4
SF-340901	34.7	9.7	1.0
SF351001	35.0	10.0	1.0
SF351580	35.0	15.0	8.0
SF352508	35.0	25.0	0.8
SF361810	36.0	18.0	1.0
SF361820	36.0	18.0	2.0
SF400509	39.5	5.0	0.9
SF-4009	40.0	9.0	1.5
SF400924	40.0	9.0	2.4
SF400930	40.0	9.0	3.0
SF401040	40.0	10.5	4.0
SF401235	40.0	12.0	3.5
SF401240	40.0	12.0	4.0
SF401250	40.0	12.0	5.0
SF401715	40.0	17.5	1.5
SF442010	44.5	20.0	10.0
SF451020	45.0	10.0	2.0
SF473530	47.5	3.5	3.0
SF481040	48.0	10.0	4.0
SF484410	48.0	44.0	1.0
SF491210	49.0	12.0	1.0
SF500620	50.0	6.0	2.0
SF501038	50.0	10.0	3.8
SF541010	54.0	10.0	1.0
SF550515	55.0	5.0	1.5

Part No.	A	B	C
SF582508	58.0	25.0	0.8
SF582514	58.0	25.0	1.4
SF582516	58.0	25.0	1.6
SF600610	60.0	6.0	1.0
SF600613	60.0	6.0	1.3
SF600625	60.0	6.0	2.5
SF-6064	60.0	6.0	4.0
SF600907	60.0	9.0	0.7
SF601010	60.0	10.0	1.0
SF601025	60.0	10.0	2.5
SF6017530	60.0	17.5	3.0
SF602010	60.0	20.0	10.0
SF606767	60.0	6.7	6.7
SF652020	65.0	20.0	2.0
SF654030	65.0	40.0	3.0
SF700525	70.0	5.0	2.5
SF701820	70.0	18.0	2.0
SF702010	70.0	20.0	1.0
SF764005	76.0	40.0	0.5
SF-801004	80.0	10.0	0.5
SF845208	84.6	52.6	0.8
SF880810	88.0	8.0	1.0
SF951232	95.0	12.0	3.2
SF980830	98.0	8.0	3.0
SF993555	99.0	3.5	5.5
SF990915	99.0	9.9	1.5
LSF-002	100.0	12.0	3.5

Part No.	A	B	C
SF107581	107.0	58.0	1.5
SF1100540	110.0	5.6	4.0
SF1101010	110.0	10.0	1.0
SF1111009	111.0	10.0	0.9
SF1200310	120.0	3.0	1.0
SF1254620	125.0	46.0	2.0
SF1302030	130.0	20.0	3.0
SF1302020	130.0	20.0	2.0
SF1340220	134.0	2.0	2.0
SF1400520	140.0	5.0	2.0
SF140101	140.0	10.0	1.0
SF140251	140.0	25.0	1.0
SF14510520	145.0	105.0	2.0
SF1461010	146.0	10.0	1.0
SF1500712	150.0	7.0	1.2
SF-1501004	150.0	10.0	0.5
SF1501515	150.0	15.0	1.5
SF1600610	160.0	6.0	1.0
SF1664930	166.5	49.0	3.0
SF2500515	250.0	5.0	1.5
SF2506520	250.0	65.0	2.0
SF2701655	270.0	165.0	0.5
SF2581420	258.0	14.5	2.0
SF3101150	310.0	11.6	5.0
SF3101250	310.0	12.0	5.0
SF5400208	540.0	2.9	0.8

# 橡膠腳墊 RUBBER FOOT

用途：背膠式，可快速將腳墊固定於機殼，黏性佳、不脫落。

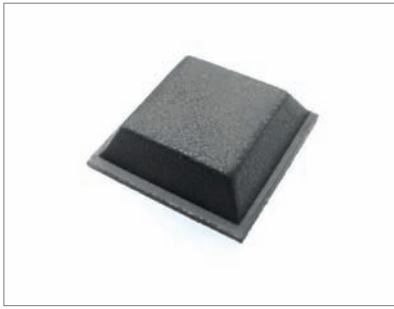

- Material: Rubber/Silicon Rubber/PU
- Color: Black
- Unit: mm

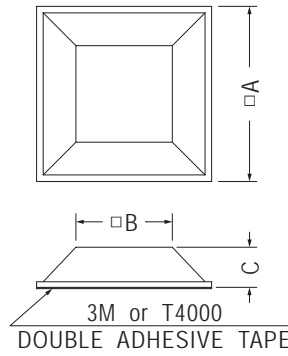

Part No.	A	B	C
SF-004	12.7	9.0	3.5
SF-005	12.7	7.0	6.0
SF-006	20.0	14.0	7.6
SF-007	10.5	8.6	2.5
SF-009	12.5	9.5	4.0
SF-016	12.7	9.8	3.0
SF-017	12.5	9.7	3.5



- Material: Rubber/Silicon Rubber
- Color: Black
- Unit: mm
- Other Materials Available: EPDM, Poron...
- Optional Thickness: 0.7-5.0mm

用途：背膠式，可快速將腳墊固定於機殼，黏性佳、不脫落。

可依客戶指定長、寬、高裁切成各種形狀，如方形、圓形。表面可分為平面、斜紋等。

Different size available per request.

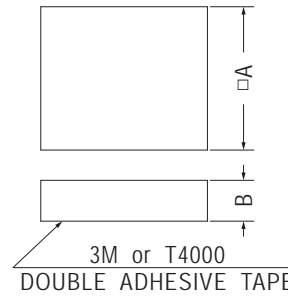

Part No.	A	B
SF050510	5.0	1.0
SF050512	5.0	1.2
SF-6610	6.0	1.0
SF-6615	6.0	1.5
SF060625	6.0	2.5
SF-664	6.0	4.0
SF-665	6.0	5.0
SF060660	6.0	6.0
SF-001	6.4	3.0
SF070715	7.0	1.5
SF070720	7.0	2.0
SF070740	7.0	4.0
SF070755	7.0	5.5
SF070780	7.0	8.0
SF73732	7.3	2.0
SF-080801	8.0	1.0
SF-080802	8.0	2.0
SF080823	8.0	2.3
SF-0808025	8.0	2.5
SF090945	9.0	4.5
SF-002	9.7	2.0

Part No.	A	B
SF-979735	9.7	3.5
SF101007	10.0	0.7
SF101009	10.0	0.9
SF101010	10.0	1.0
SF101016	10.0	1.6
SF101020	10.0	2.0
SF101023	10.0	2.3
SF101025	10.0	2.5
SF101030	10.0	3.0
SF101035	10.0	3.5
SF101040	10.0	4.0
SF101050	10.0	5.0
SF101060	10.0	6.0
SF111160	11.0	6.0
SF11511550	11.5	5.0
SF11511565	11.5	6.5
SF-121212	12.0	1.2
SF121225	12.0	2.5
SF-003	12.0	5.0
SF121255	12.0	5.5

Part No.	A	B
SF121270	12.0	7.0
SF-1272	12.7	2.3
SF-131320	13.0	2.0
SF14142	14.0	2.0
SF141480	14.0	8.0
SF151512	15.0	1.2
SF-151515	15.0	1.5
SF151535	15.0	3.5
SF151550	15.0	5.0
SF161610	16.0	1.0
SF171725	17.0	2.5
SF181810	18.0	1.0
SF181820	18.0	2.0
SF181840	18.0	4.0
SF181850	18.0	5.0
SF202030	20.0	3.0
SF25425450	25.4	5.0
SF404010	40.0	1.0
SF404050	40.0	5.0
SF505050	50.0	5.0

# 橡膠腳墊 RUBBER FOOT



- Material: Rubber/Silicon Rubber
- Color: Black
- Unit: mm
- Other Materials Available: EPDM

用途：背膠式，可快速將腳墊固定於機殼，黏性佳、不脫落。

尺寸可依客戶要求。  
Different size available per request.

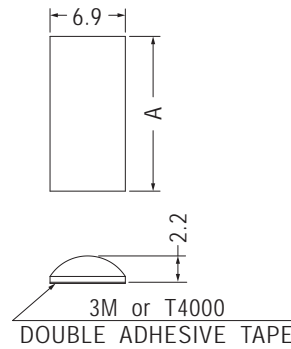

Part No.	A
SF14722	14.0
SF28722	27.8



- Material: Rubber
- Color: Black
- Unit: mm

用途：背膠式，可快速將腳墊固定於機殼，黏性佳、不脫落。

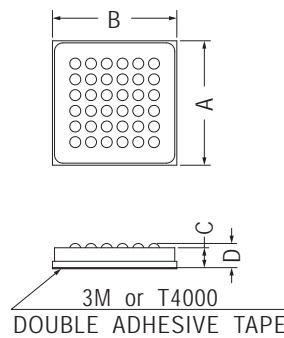

Part No.	A	B	C	D
P004	14.0	13.5	2.1	2.6
P005	15.0	14.5	2.6	3.1

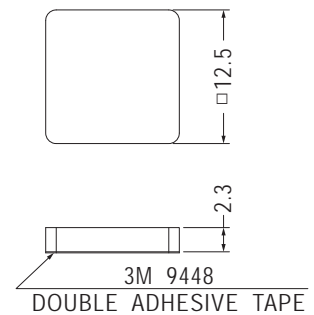
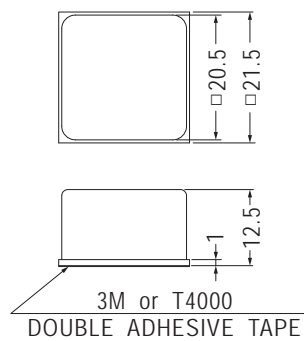

- Color: Computer

Part No.	Package
SF202013	1000

Part No.	Package
TF-1698	1000



# 橡膠腳墊 RUBBER FOOT

用途：背膠式，可快速將腳墊固定於機殼，黏性佳、不脫落。



- Material: Rubber/Silicon Rubber
- Color: Black
- Unit: mm
- Other Materials Available: EPDM

尺寸可依客戶要求。  
Different size available per request.

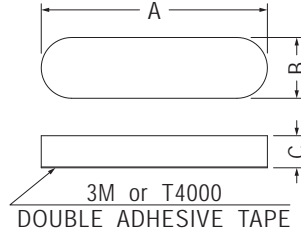

Part No.	A	B	C
PT080210	8.0	2.0	1.0
PT100612	10.5	6.0	1.2
PT100614	10.5	6.0	1.4
TF-1627	15.2	9.2	3.0
PT158932S	15.8	9.3	2.0
PT160915	16.0	9.5	1.5
PT-1762	17.5	6.5	2.0
PT200612	20.5	6.2	1.2
PT200617	20.5	6.2	1.7
PT2492	24.0	9.0	2.0
PT270720	26.8	7.2	2.0
PT005	26.8	7.2	3.8
PT360712	36.0	7.0	1.2
PT690920	69.6	9.8	2.0



- Material: Rubber
- Color: Black
- Unit: mm

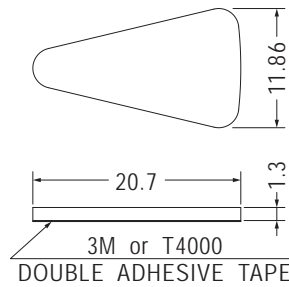

Part No.	Package
TF201113	1000

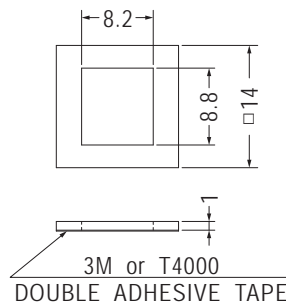

Part No.
SF141410



- Material: Silicon Rubber
- Color: Black
- Unit: mm

用途：背膠式，可貼於D-SUB連接器之外觀或裡面保護或絕緣。

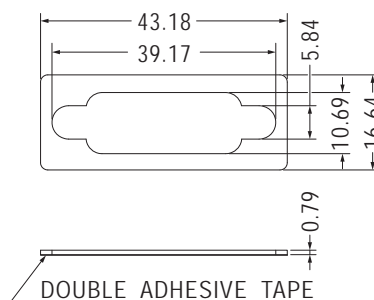

Part No.	Package
TF-1596	1000

## EVA泡棉 EVA FOAM

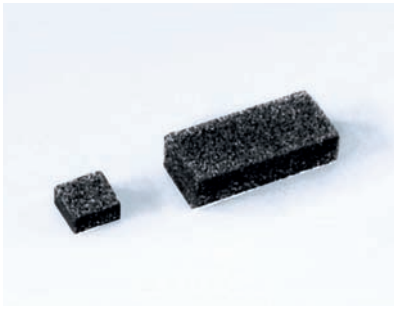

- Material: EVA
- Color: Black
- Unit: mm

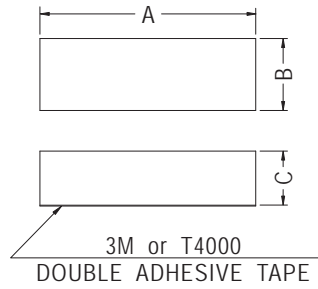

用途：腳墊，零件之絕緣，可用背膠（單面或雙面）。

尺寸可依客戶要求。  
Different size available per request.

Part No.	A	B	C
EVA862	8.0	6.0	2.0
EVA120430	12.0	4.0	3.0

## 功率晶體導熱矽膠片 TRANSISTOR THERMAL CONDUCTIVE PAD

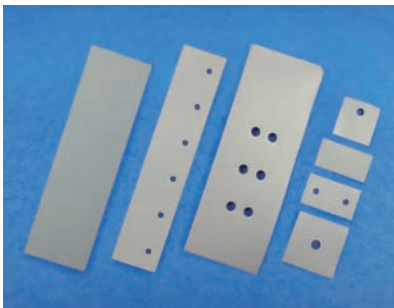

- Material: Silicon (UL)
- Flame Class: 94V-0
- Color: Gray
- Unit: mm

用途：用於功率晶體之導熱和絕緣。

可依客戶指定長、寬、高裁切成各種形狀，如方形、圓形。

Different size available per request.

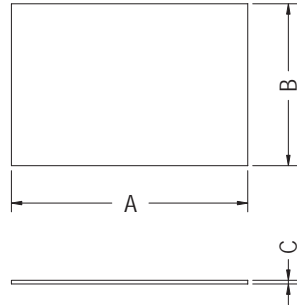

Part No.	A	B	C	Package
SI1913	19.0	13.0	0.3	1000
SI21125	21.0	12.5	0.3	
SI2519	25.0	19.0	0.3	
SI3012	30.0	12.0	0.3	
SI3030-1	30.0	30.0	0.3	
SI4520	45.0	20.5	0.3	
SI304802	48.0	30.0	0.23	100
SI300200	300.0	200.0	0.3	

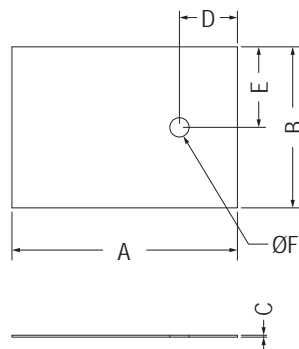

Part No.	A	B	C	D	E	F	Package
SI3023	30.0	23.0	0.3	15.0	12.6	3.0	1000
SI3030	30.0	30.0	0.45	15.0	15.0	4.5	
SI2535	35.0	25.0	0.3	9.0	12.5	3.0	

用途：用於功率晶體之導熱和絕緣。

- Material: Silicon (UL)
- Flame Class: 94V-0
- Color: Gray
- Unit: mm

可依客戶指定長、寬、高裁切成各種形狀，如方形、圓形。

Different size available per request.

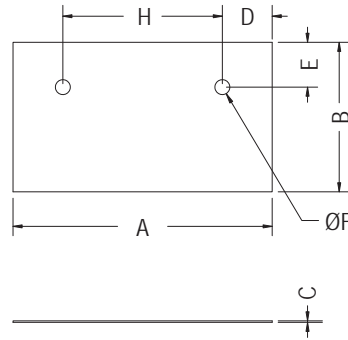
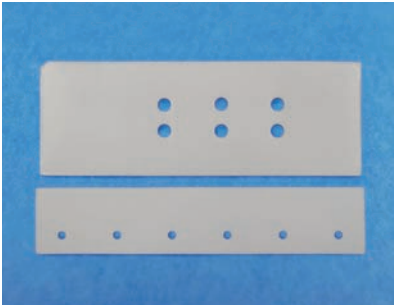
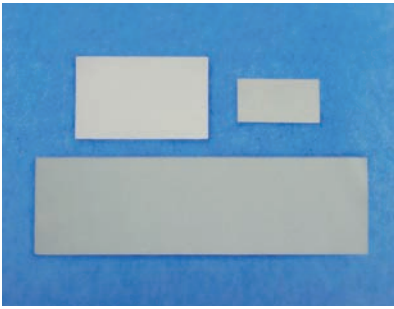

Part No.	A	B	C	D	E	F	H	Package
SI30172H	30.5	17.8	0.3	6.4	8.9	3.1	17.7	1000
SI335125H2	33.5	12.5	0.3	5.75	7.0	3.0	22.0	
SI34132H	34.0	13.0	0.3	5.0	6.5	5.8	24.0	
SI5230	52.0	30.0	0.3	10.0	9.0	3.0	32.0	
SI752845	75.0	28.0	0.45	27.0	7.5	3.2	21.0	

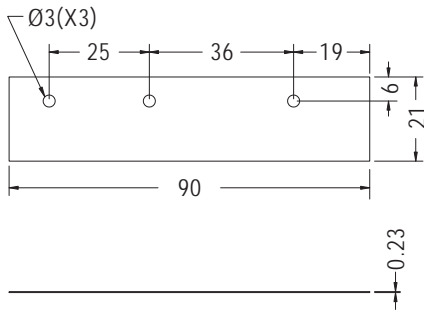

Part No.	Package
SI9021	500

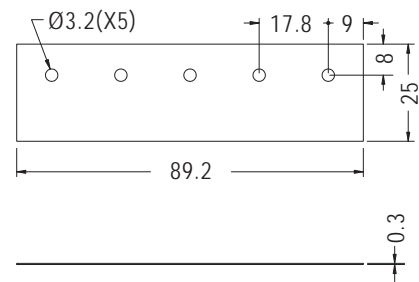

Part No.	Package
SI8925H5	500

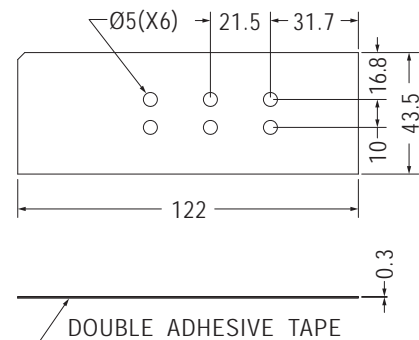

Part No.	Package
SI12243H6A	1000

# 導電泡棉 CONDUCTIVE FOAM

- Material: EMI Conductive Fabric
- Unit: mm

用途：EMI屏蔽導電，可用背膠(單面或雙面)，尺寸可依客戶要求。  
Different size available per request.



Part No.	Package
CRGI01	1000



Part No.	Package
CRGH06	1000



Part No.	Package
CRGP11	1000

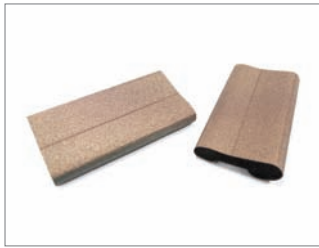

Part No.	Package
CRGF02	1000

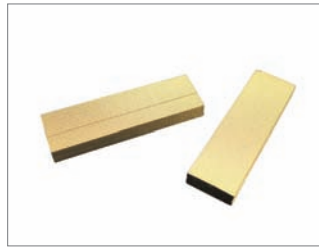

Part No.	Package
CRGR-G07	1000



Part No.	Package
CRGI12	1000



Part No.	Package
CRGS03	1000



Part No.	Package
CRGR08	1000



Part No.	Package
CRGT13	1000



Part No.	Package
CRGR04	1000



Part No.	Package
CRGC09	1000



Part No.	Package
CRGD14	1000



Part No.	Package
CRGI-E05	1000



Part No.	Package
CRGL10	1000



Part No.	Package
CRGI-W15	1000