

7



- USB座護蓋
USB Housing
- 防塵蓋
Connector Cover
- 光纖連接器護套
Fiber Optic
Connector Cover
- 電源插座防塵蓋
Power Connector Cover
- 螺絲固定座
Plastic Conical Anchors
- 鉚釘
Snap Rivet
- 風扇鉚釘
Fan Mount Rivet
- 散熱片扣件
Heat Sink Rivet
- 門扣
Door Lock



USB座護蓋 USB PORT COVER

用途：用於USB接頭防塵與保護。

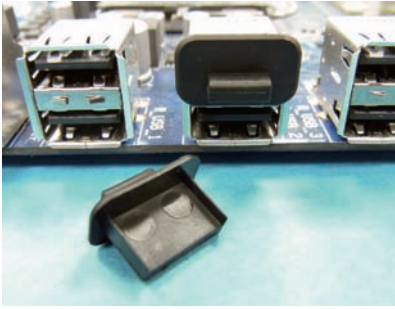

- Material: ABS (UL)
- Flame Class: 94HB
- Color: Black
- Unit: mm

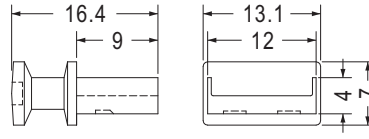

Part No.	Package
USBC-2	1000

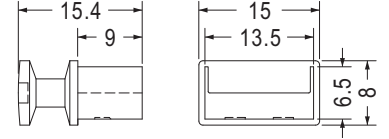

Part No.	Package
USBC-6	1000

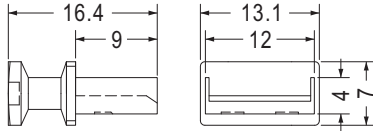

Part No.	Package
USBC-24	1000

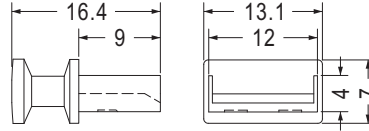

Part No.	Package
USBC-37	1000

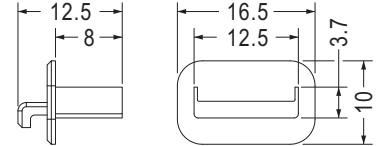

- Material: PP
- Color: Black

Part No.	Package
USBC-14	1000

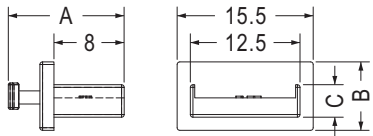

- Material: PP (UL)
- Flame Class: 94HB
- Color: Natural/Black

Part No.	A	B	C	Package
USBC-33	13.2	7.8	3.7	1000
USBC-33-1	14.5	8.0	3.8	

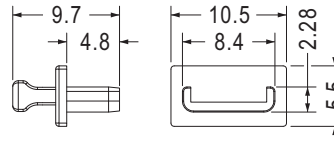

- Material: Nylon 66 (UL)
- Flame Class: 94V-2/94V-0

Part No.	Package
USBC-43	1000

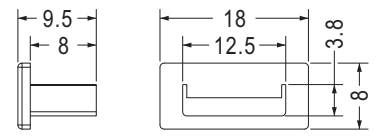

- Material: TPE (UL)
- Flame Class: 94V-0

Part No.	Package
USBC-33-2	1000

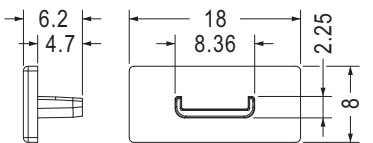

- Material: TPE (UL)
- Flame Class: 94V-0

Part No.	Package
USBC-43-1	1000

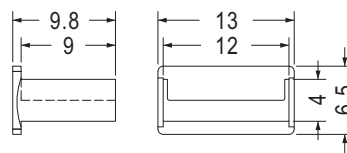

- Material: PP
- Color: Black/Computer

Part No.	Package
USBC-4	1000

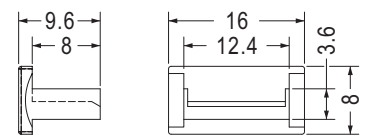

Part No.	Package
USBC-11	1000



- Material: Nylon 66 (UL)
- Flame Class: 94V-2/94V-0
- Color: Natural/Black
- Unit: mm

用途：用於重要的USB接頭之堵塞，避免重要資料洩漏。拔卸困難，兼具防塵與保護。

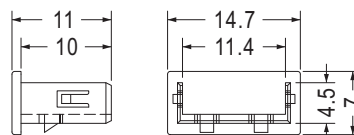

不可重複使用 Not Reusable

Part No.	Package
USBC-8	1000

USB座護蓋 USB PORT COVER

用途：用於USB TYPE A DIP接頭，拔卸困難，兼具防塵與保護。



- Material: Nylon 66 (UL)
- Flame Class: 94V-2/94V-0
- Color: Natural/Black
- Unit: mm

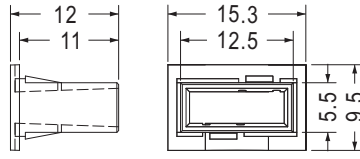

Part No.	Package
USBC-7	1000

不可重複使用 Not Reusable



- Material: PP
- Color: Black
- Unit: mm

用途：用於USB接頭防塵與保護。

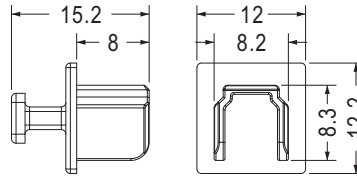

Part No.	Package
USBC-34	1000

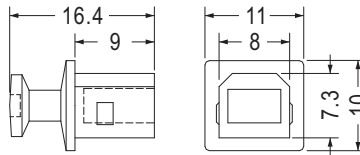

- Material: ABS (UL)
- Flame Class: 94HB

Part No.	Package
USBC-1	1000

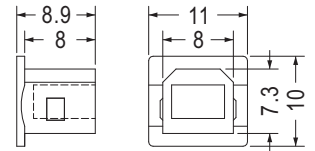

- Color: Black/Computer

Part No.	Package
USBC-3	1000



- Material: Nylon 66 (UL)
- Flame Class: 94V-2/94V-0
- Color: Black
- Unit: mm

用途：用於POWER USB接頭防塵與保護。

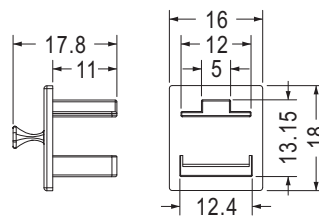

Part No.	Package
USBC-42	1000

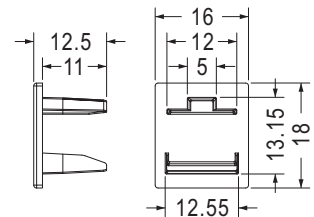

- Material: TPE (UL)
- Flame Class: 94V-0

Part No.	Package
USBC-42-1	1000

MICRO USB防塵蓋 MICRO USB PORT COVER

用途：用於MICRO USB接頭防塵與保護。



- Material: TPE
- Color: Black
- Unit: mm

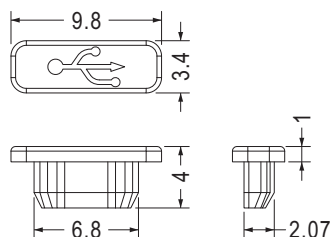

Part No.	Package
USBC-15	1000

MICRO USB防塵蓋 MICRO USB PORT COVER

用途：用於MICRO USB接頭防塵與保護。



- Material: PE
- Color: Black
- Unit: mm

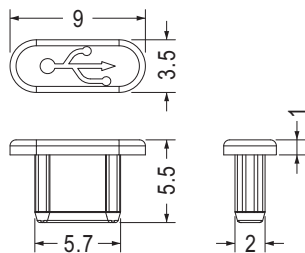

Part No.	Package
USBC-31	1000

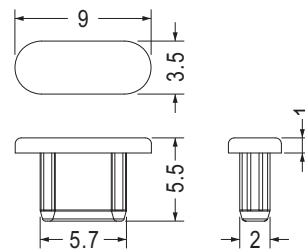

- Material: TPE (UL)
- Flame Class: 94V-0

Part No.	Package
USBC-31-1	1000

MINI USB座護蓋 MINI USB PORT COVER

用途：用於MINI USB接頭防塵與保護。



- Material: PP (UL)
- Flame Class: 94HB
- Color: Black
- Unit: mm

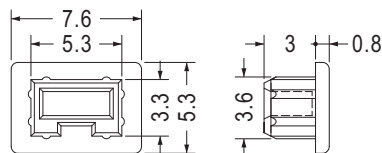

Part No.	Package
USBC-9	1000



- Material: TPE
- Color: Black
- Unit: mm

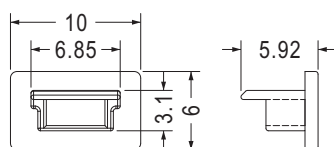

Part No.	Package
USBC-10	1000

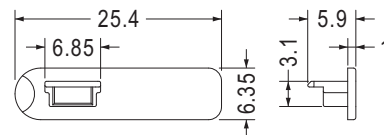

Part No.	Package
USBC-13	1000

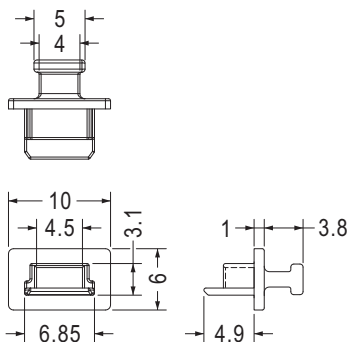

Part No.	Package
USBC-25	1000

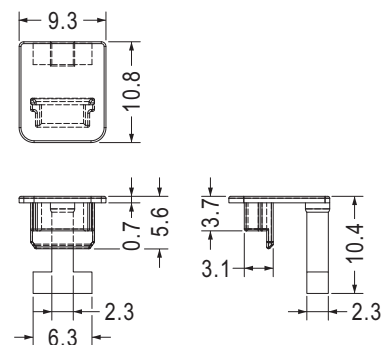

Part No.	Package
USBC-16	1000

MINI SAS HD防塵蓋 MINI SAS HD COVER

用途：用於MINI SAS HD接頭防塵與保護。

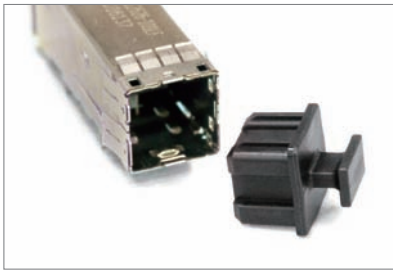

- Material: PE
- Color: Black
- Unit: mm

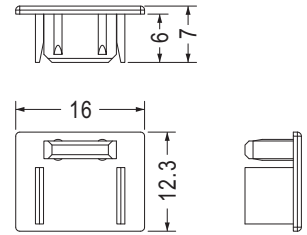
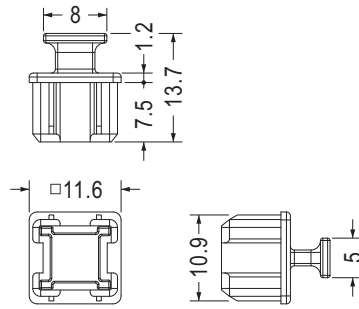

- Material: TPE

Part No.	Package
KPS-32	1000

Part No.	Package
KPS-39	1000



USB座護蓋 USB PORT COVER

用途：用於USB接頭防塵與保護。



- Material: TPE
- Color: Black
- Unit: mm

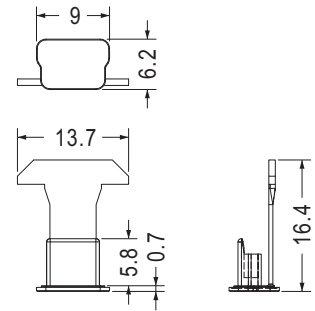
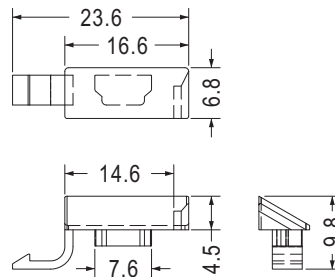

- Material: TPU

Part No.	Package
USBC-17	1000

Part No.	Package
USBC-30	1000

防塵蓋 CONNECTOR COVER

用途：用於汽車點菸器防塵與保護用。



- Material: TPE
- Color: Black
- Unit: mm

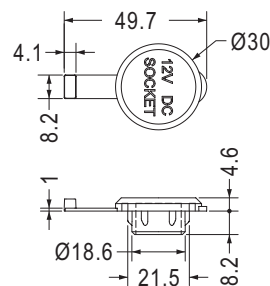

Part No.	Package
DCVER-1	500



- Material: TPE
- Color: Black
- Unit: mm

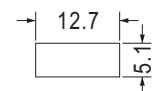
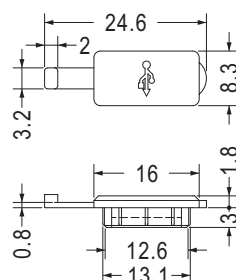

MOUNTING HOLE

Part No.	Package
COVER-1	500

防塵蓋 CONNECTOR COVER

用途：用於USB接頭防塵與保護。



- Material: Silicon Rubber (UL)
- Flame Class: 94V-0
- Color: Black
- Unit: mm

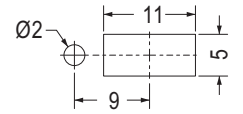
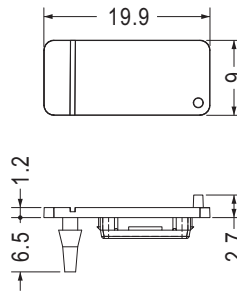

MOUNTING HOLE
THICKNESS 1.0

Part No.	Package
CJCV-3	1000

- Material: Silicon Rubber
- Color: Black
- Unit: mm

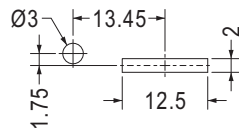
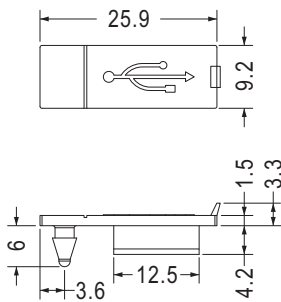

MOUNTING HOLE
THICKNESS 1.5

Part No.	Package
CJCV-7	1000

- Material: TPU
- Color: Black/White
- Unit: mm

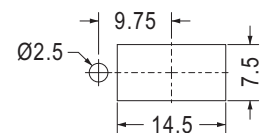
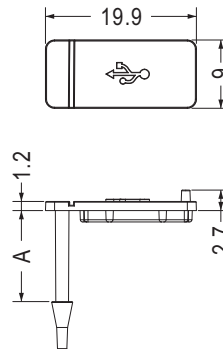

MOUNTING HOLE

Part No.	A	Package
CJCV-1	1.8	500
CJCV-2	12.0	

BBU防塵蓋 CONNECTOR COVER

用途：用於BBU的防塵與保護用。



- Material: TPU
- Color: Black
- Unit: mm

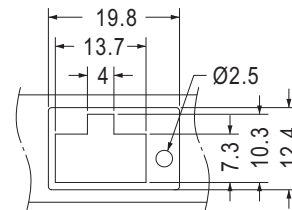
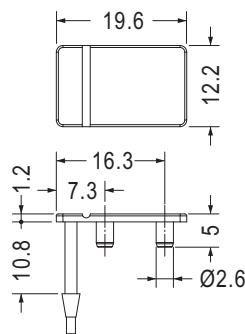

MOUNTING HOLE

Part No.	Package
CJCV-4	1000



- Material: TPE (UL)
- Flame Class: 94V-0
- Color: Black
- Unit: mm

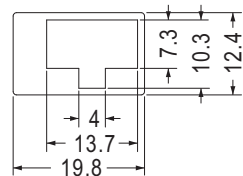
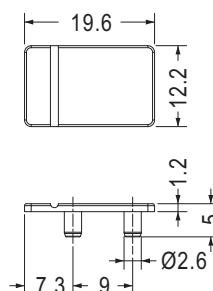

MOUNTING HOLE
(RECOMMEND FOR REFERENCE ONLY)

Part No.	Package
★CJCV-12	1000

連接器蓋 CONNECTOR COVER

用途：用於連接器防塵與保護。



- Material: TPU
- Color: Black/White
- Unit: mm

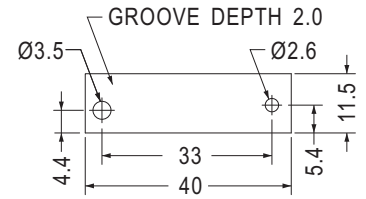
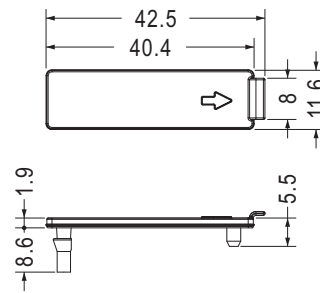

MOUNTING HOLE

Part No.	Package
EMC-1	500

SIM卡蓋 SIM CARD CAP

用途：用於SIM卡防塵與保護用。



- Material: TPU
- Color: Black/White
- Unit: mm

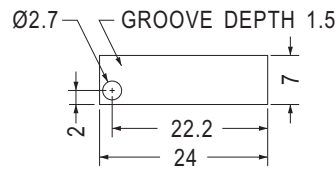
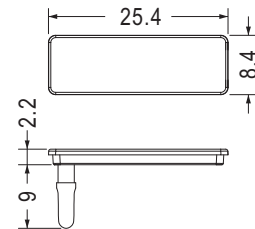
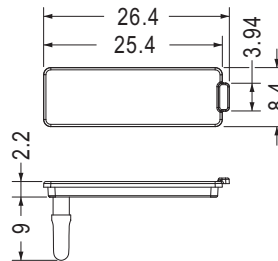

MOUNTING HOLE

Part No.	Package
EM-303	500

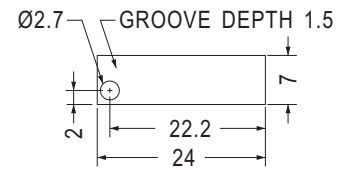

MOUNTING HOLE

Part No.	Package
EM-303-1	500

SD防塵蓋 SD CONNECTOR COVER

用途：用於SD卡防塵與保護用。



- Material: TPE
- Color: Black
- Unit: mm

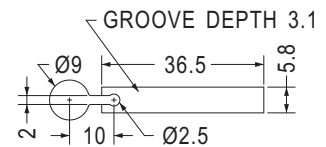
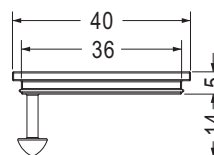

MOUNTING HOLE

Part No.	Package
CJCV-6	1000

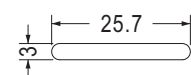
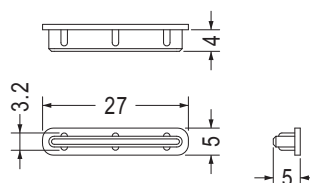

MOUNTING HOLE

Part No.	Package
CJCV-11	1000

USB TYPE-C防塵蓋 USB 3.0 TYPE-C COVER

用途：用於USB 3.0 TYPE-C接頭之防塵與保護。



- Material: PE
- Color: Black
- Unit: mm

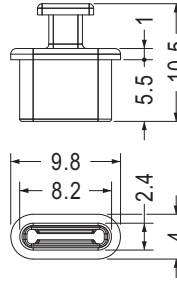

Part No.	Package
USB3C-1	1000

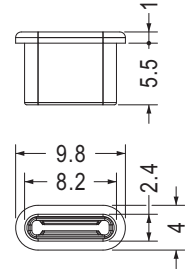

Part No.	Package
USB3C-2	1000

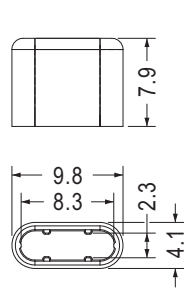

Part No.	Package
USB3C-3	1000

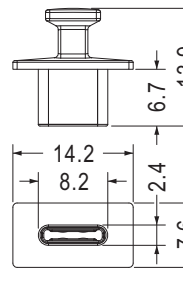

Part No.	Package
USB3C-4	1000

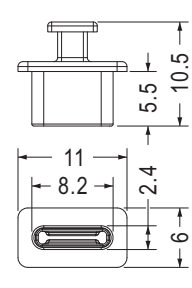

Part No.	Package
USB3C-7	1000

USB座護蓋 USB COVER

用途：用於USB 3.0接頭防塵與保護。



- Material: TPE
- Color: Black
- Unit: mm

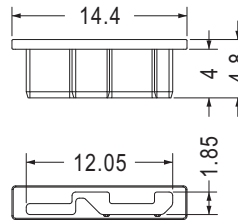

Part No.	Package
USB21	1000

防塵蓋 CONNECTOR COVER

用途：用於KVM連接器之防塵與保護。

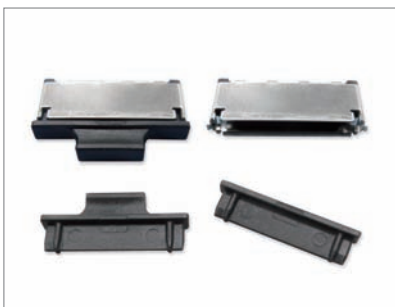

- Material: PE
- Color: Black
- Unit: mm

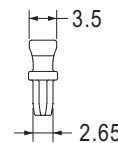
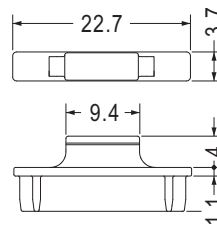

Part No.	Package
KVM-1	1000
KVM-2	

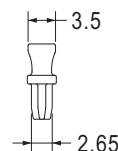
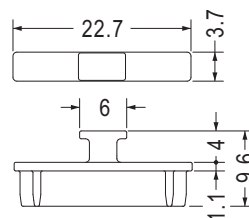

Part No.	Package
KVM-3	1000

CF防塵蓋 CONNECTOR COVER

用途：用於CF連接器之防塵與保護。

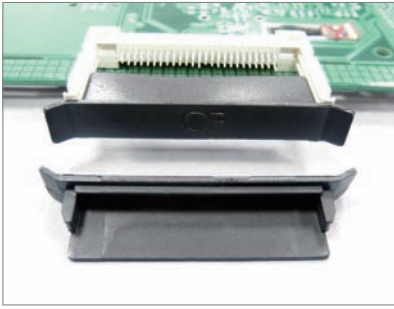

- Material: TPU
- Color: Black
- Unit: mm

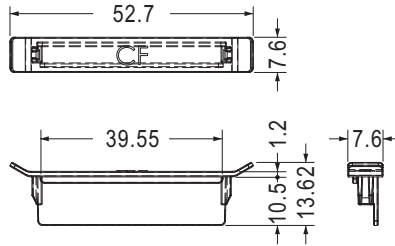

Part No.	Package
CFC-1	500

USB座護蓋 USB HOUSING

用途：用於USB防塵與保護。

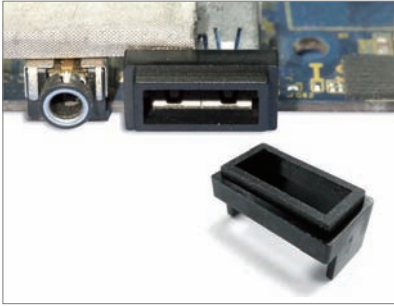

- Material: Nylon 66 (UL)
- Flame Class: 94V-2/94V-0
- Color: Natural/Black
- Unit: mm

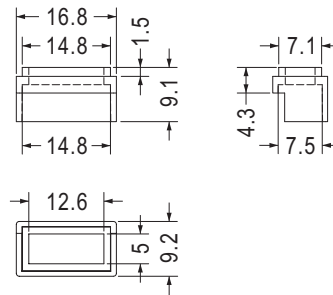

Part No.	Package
USBH-1	1000

IPHONE防塵蓋 IPHONE COVER

用途：用於iPhone連接器的防塵與保護用。



- Material: TPU
- Color: Black
- Unit: mm

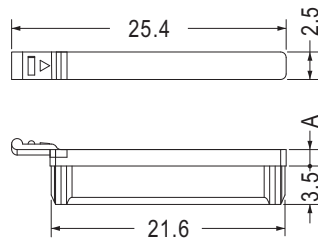

Part No.	A	For	Package
IPOD-1	1.5	iPhone 3	1000
IPOD-2	1.0	iPhone 4	

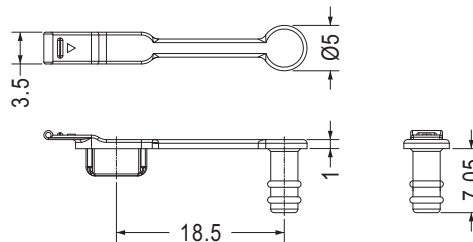

Part No.	Package
IPOD-3	1000

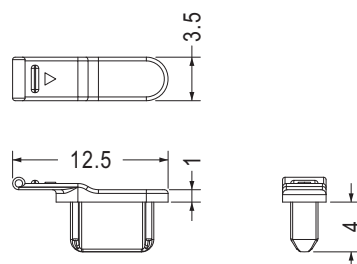

Part No.	Package
IPOD-4	1000

防塵蓋 CONNECTOR COVER



- Material: Nylon 66 (UL)
- Flame Class: 94V-2/94V-0
- Color: Black
- Unit: mm

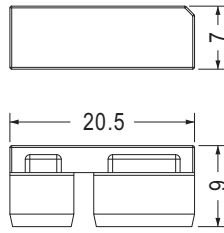

用途：使用於PCI-E X1連接器的防塵與保護用。

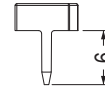

Part No.	Package
PCIEX-1	1000

IPHONE防塵蓋 IPHONE CONNECTOR COVER



- Material: PE
- Color: Natural
- Unit: mm

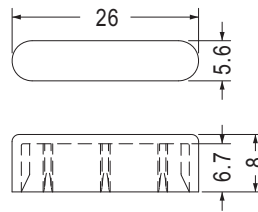

用途：用於iPhone充電器接頭之防塵與保護。

Part No.	Package
IPWC-1	1000

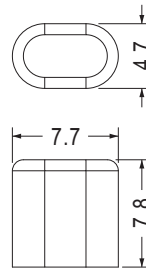

Part No.	Package
IPWC-2	2000

防塵蓋 MINI USB PLUG COVER



- Material: PE
- Color: Natural
- Unit: mm

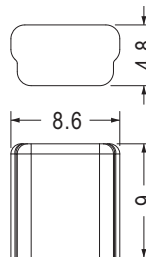

用途：用於Mini USB接頭之防塵與保護。

Part No.	Package
KPS-20	2000

MICRO USB防塵蓋 MICRO USB PLUG COVER



- Material: PE
- Color: Natural
- Unit: mm

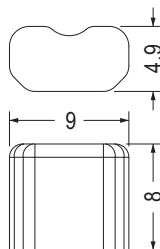

用途：用於Micro USB接頭防塵與保護。

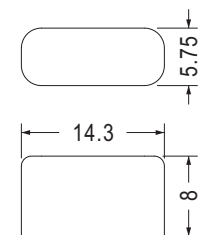

Part No.	Package
KPS-21	2000

Part No.	Package
KPS-24	1000

防塵蓋 CONNECTOR COVER

用途：用於RJ-11連接器之防塵與保護。



- Material: PE
- Color: Natural
- Unit: mm

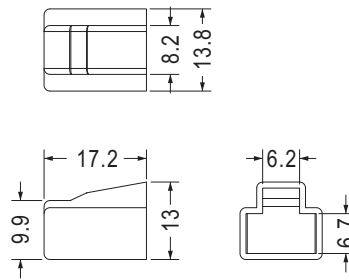

Part No.	Package
PJCV-1	1000

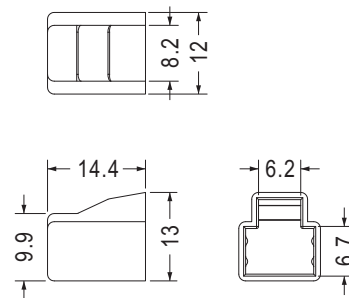

Part No.	Package
PJCV-11	1000



- Material: PE
- Color: Natural
- Unit: mm

用途：用於USB接頭防塵與保護。

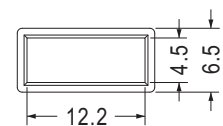
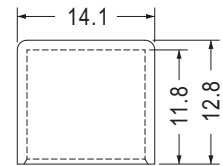
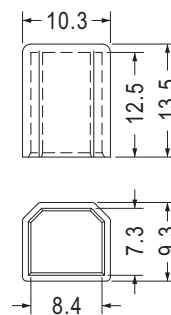

Part No.	Package
KPS-5	1000

Part No.	Package
KPS-6	1000



- Material: PE
- Color: Natural
- Unit: mm

用途：用於連接器防塵與保護。

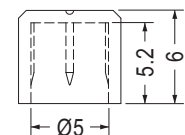
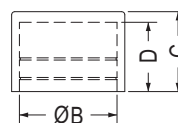
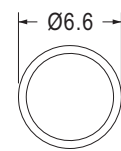
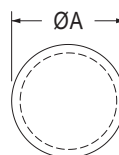

Part No.	A	B	C	D	Package
KPS-1	15.8	13.4	11.2	10.0	500
KPS-2	10.7	9.0	9.6	8.6	1000
KPS-3	10.3	8.4	8.0	7.0	

Part No.	Package
KPS-16	1000

連接器蓋 CONNECTOR COVER

用途：用於天線連接器之防塵與保護。



- Material: Silicon Rubber
- Color: Black
- Unit: mm

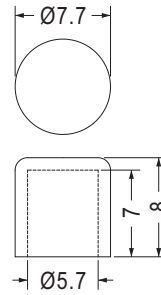

Part No.	Package
TF-589	1000

防塵蓋 CONNECTOR COVER

用途：用於連接器防塵與保護。



- Material: PE
- Color: Natural/White/Black
- Unit: mm

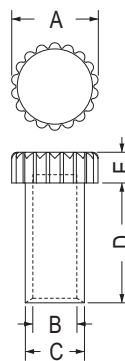

Part No.	A	B	C	D	E	Package
KPSA-1	5.7	2.85	3.85	7.8	2.0	1000
KPSA-3	4.5	2.3	3.3	3.5	3.2	

光纖連接器護蓋 OPTICAL PORT COVER

用途：用於光纖連接器之防塵與保護。



- Material: PE
- Color: Natural
- Unit: mm

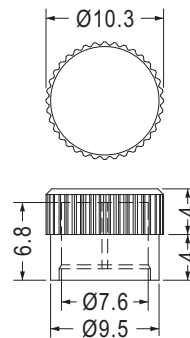

Part No.	Package
KPS-4	1000

端子蓋 CONNECTOR COVER

用途：用於連接器RCA端子之防塵與保護用。



- Material: PE
- Color: Natural
- Unit: mm

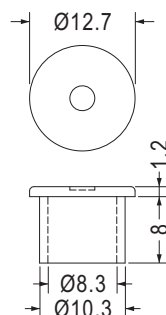

Part No.	Package
KPS-9	1000

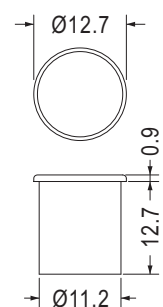

Part No.	Package
CRCAM-1	1000

端子蓋 CONNECTOR COVER

用途：用於F端子之防塵與保護用。



- Material: PE
- Color: Natural/Black
- Unit: mm

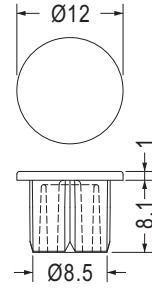
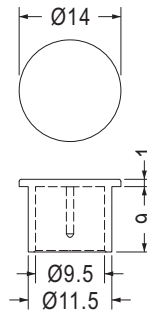

- Color: Natural

Part No.	Package
KPS-12	1000

Part No.	Package
KPS-31	1000



- Material: PE
- Color: Natural/Black
- Unit: mm

用途：用於天線端子之防塵與保護。

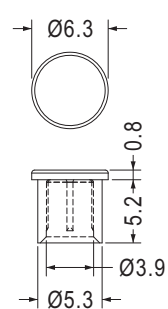
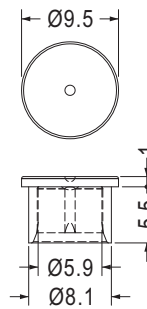

Part No.	Package
KPS-29	1000

Part No.	Package
★KPS-46	1000

S端子蓋 S-VIDEO PLUG COVER

用途：S端子之防塵與保護。



- Material: PP
- Color: Natural/Black
- Unit: mm

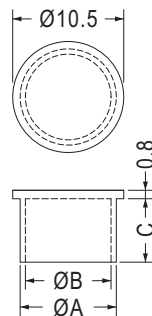

Part No.	A	B	C	Package
SVDOC-1	9.0	8.0	9.6	1000
SVDOC-3	9.1	8.1	6.0	

端子蓋 CONNECTOR COVER

用途：用於端子之防塵與保護。



- Material: PP
- Color: Black
- Unit: mm

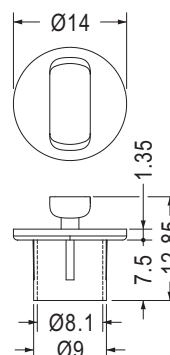

Part No.	Package
MOUC-1	1000

端子蓋 CONNECTOR COVER

用途：用於端子之防塵與保護。



- Material: PP (UL)
- Flame Class: 94HB
- Color: Black
- Unit: mm

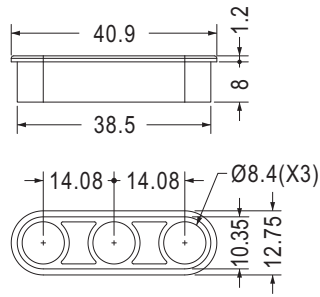

Part No.	Package
KPS-13	1000

防塵蓋 CONNECTOR COVER

用途：用於電源連接器防塵與保護。

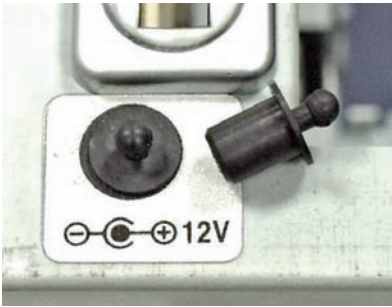

- Material: Rubber
- Color: Black
- Unit: mm

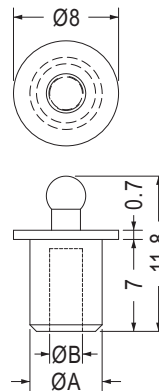

Part No.	A	B	Package
JKCV-1	5.5	2.5	1000
JKCV-4	4.0	2.0	



- Material: PP (UL)
- Flame Class: 94HB
- Color: Black
- Unit: mm

用途：用於連接器防塵與保護。

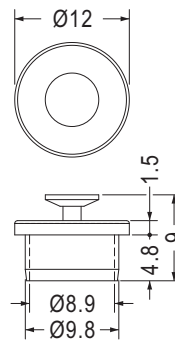

Part No.	Package
KPS-18	1000



- Material: PE
- Color: Black/Red
- Unit: mm

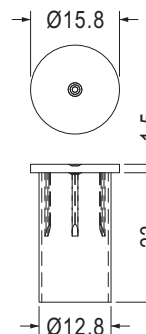

Part No.	Package
KPS-15	1000

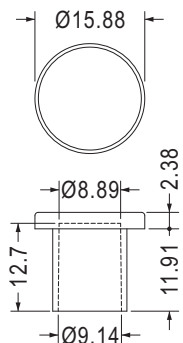

Part No.	Package
KPS-19	1000

S端子蓋 S-VIDEO PORT COVER



- Material: PP
- Color: Natural
- Unit: mm

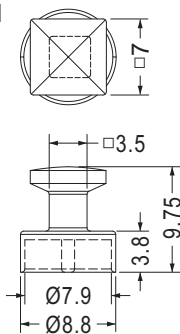

Part No.	Package
SVDOC-1S	1000

用途：S端子之防塵蓋、美觀。

- Material: PE
- Color: Natural
- Unit: mm

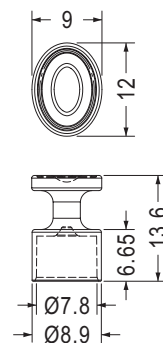

Part No.	Package
SVDOC-2	1000

平衡端子蓋 BALANCED PORT COVER



- Material: PP/PE
- Color: Computer
- Unit: mm

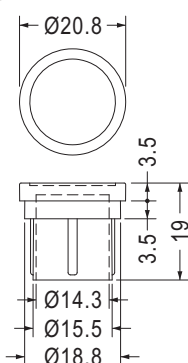

Part No.	Package
XLR-1	250

用途：平衡端子XLR座之防塵蓋、美觀。

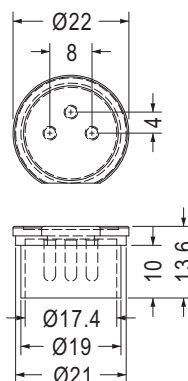

Part No.	Package
XLR-2	250

BNC絕緣座 BNC ROUND HOUSING



- Material: ABS (UL)
- Flame Class: 94HB
- Color: Natural
- Unit: mm

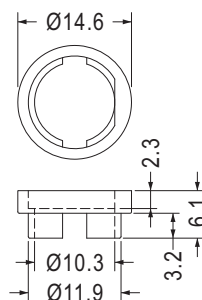

Part No.	Package
BNCH-1	1000

用途：用於BNC端子之絕緣。

BNC防塵蓋 BNC CONNECTOR COVER



- Material: PE
- Color: Black/Gray
- Unit: mm

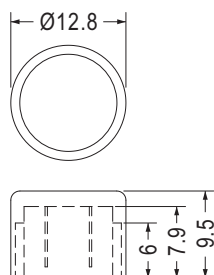

Part No.	Package
BNC-2	1000

用途：用於BNC接頭防塵保護用。

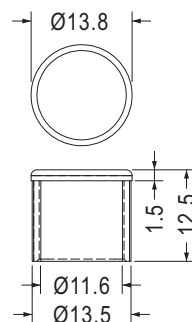

- Color: Natural

Part No.	Package
BNC-4	1000

端子蓋 CONNECTOR HOUSING

用途：RJ-45轉接RJ-11接頭。

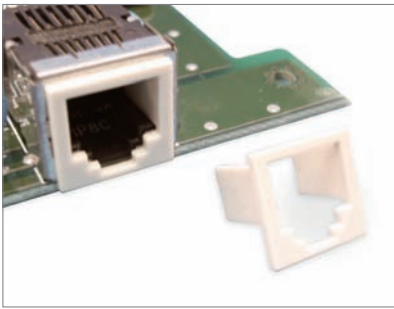

- Material: ABS (UL)
- Flame Class: 94HB
- Color: Natural/White
- Unit: mm

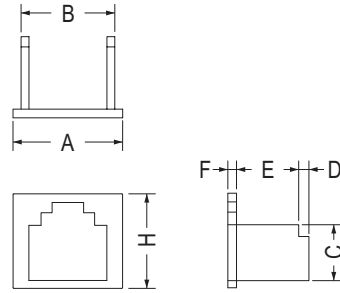

Part No.	A	B	C	D	E	F	H	Package
ASID-1	13.5	12.0	6.8	8.0	1.1	12.9	1000	
ASID-2	13.9	11.9	7.1	1.3	7.9	12.0		
ASID-3	11.8	9.6	7.0	1.5	8.0	1.0		12.5

RJ防塵蓋 RJ COVER

用途：用於RJ-11連接器之防塵蓋。



- Material: PE
- Color: Black
- Unit: mm

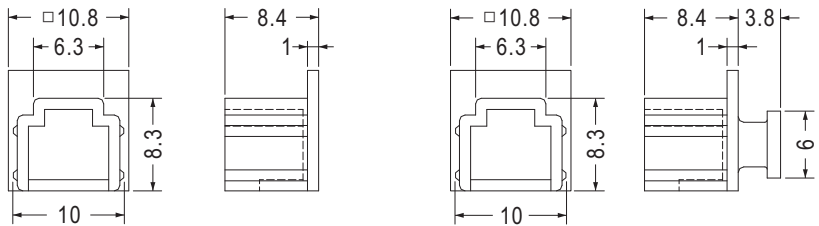

Part No.	Package
CRJ-11	1000

Part No.	Package
CRJ-11S	1000

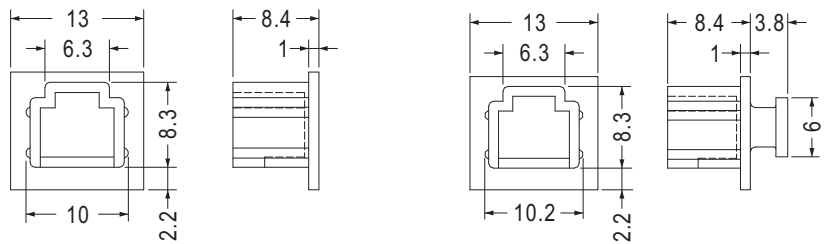

Part No.	Package
CRJ-11-2	1000

Part No.	Package
CRJ-11-2S	1000

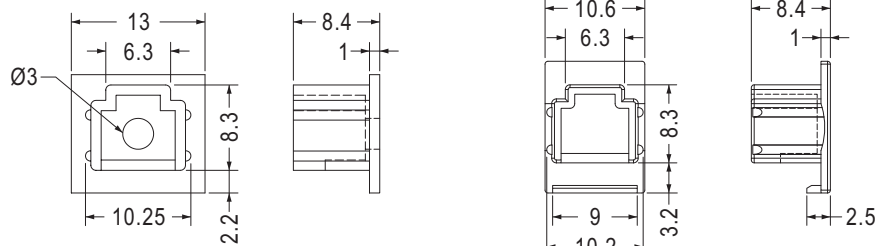
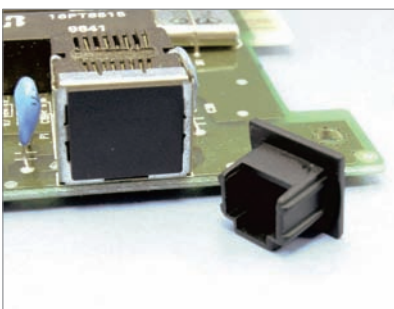

Part No.	Package
CRJ-11-3	1000

Part No.	Package
CRJ-11-6	1000

RJ防塵蓋 RJ COVER

用途：用於多餘的RJ-11連接器之堵塞，避免誤用。

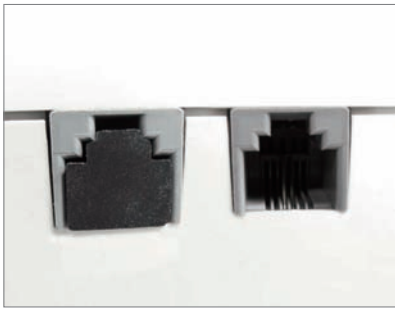

- Material: Silicon Rubber
- Color: Black
- Unit: mm

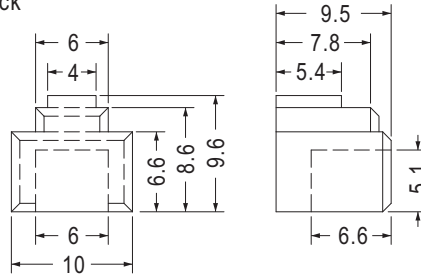

Part No.	Package
CRJ-11-4I	1000



- Material: Nylon 66 (UL)
- Flame Class: 94V-2/94V-0
- Color: Natural/Black
- Unit: mm

用途：用於RJ-11連接器之防塵蓋。

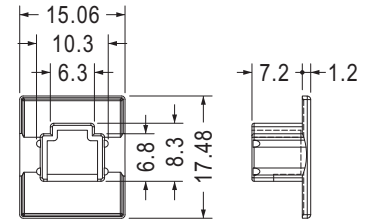
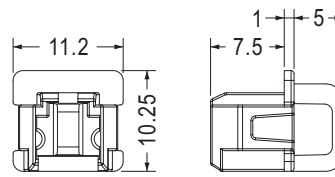

- Material: PE
- Color: White

Part No.	Package
CRJ-11-5	1000

Part No.	Package
CRJ-11-7	1000



- Material: Nylon 66 (UL)
- Flame Class: 94V-2/94V-0
- Color: Natural/Black
- Unit: mm

用途：用於網路接頭RJ-12防塵與保護。

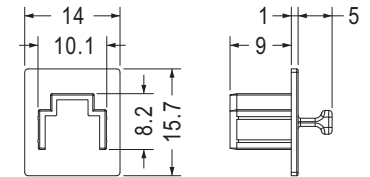
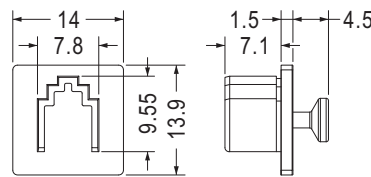

- Color: Black/Gray

Part No.	Package
CRJ-12	1000

Part No.	Package
CRJ-12-1	1000



- Material: PE
- Color: Black
- Unit: mm

用途：用於網路接頭RJ-22防塵與保護。

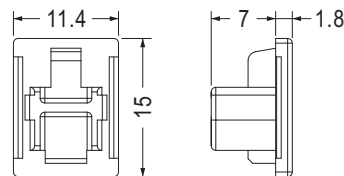

Part No.	Package
RJ-22	1000

RJ-45防塵蓋 RJ45 COVER

用途：用於多餘的RJ-45連接器之堵塞，避免誤用。

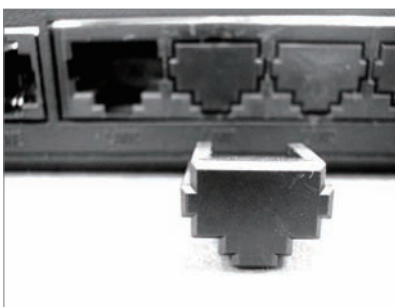

- Material: PE
- Color: Black
- Unit: mm

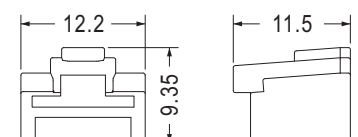
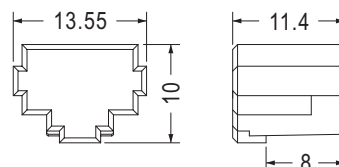

Part No.	Package
PJT-45	500

Part No.	Package
PJU-45	500

RJ-45防塵蓋 RJ45 COVER

用途：用於網路接頭RJ-45防塵與保護。



- Material: Nylon 66 (UL)
- Flame Class: 94V-2/94V-0
- Color: Natural/Black
- Unit: mm

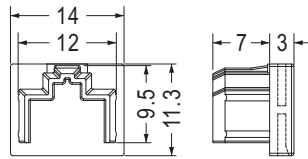

Part No.	Package
PJB-45	1000

- Material: PE
- Color: Gray
- Unit: mm

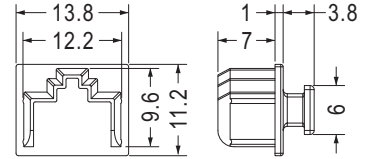

Part No.	Package
PJBA-45	1000



- Material: ABS
- Color: White
- Unit: mm

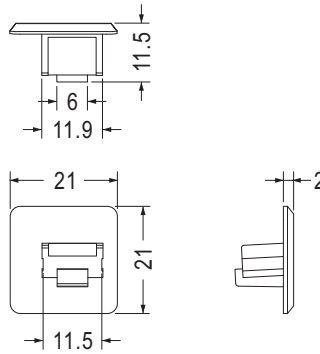

Part No.	Package
PJSA-45	1000



- Material: PE
- Color: Black
- Unit: mm

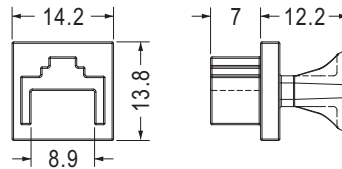

Part No.	Package
RJ-45	500



- Material: ABS (UL)
- Flame Class: 94HB
- Color: Black
- Unit: mm

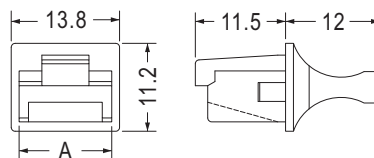

Part No.	A	Package
PJC-45	11.9	500
PJC-45L	12.0	500

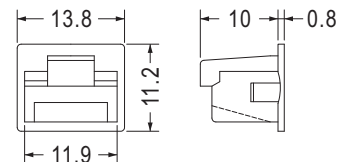

Part No.	Package
PJS-45	500

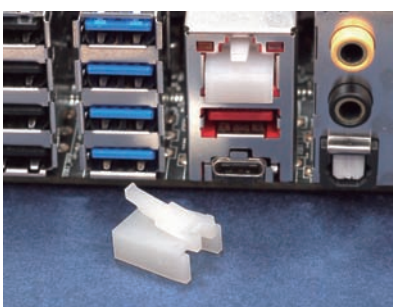

- Material: Nylon 66 (UL)
- Flame Class: 94V-2/94V-0
- Color: Natural/Black
- Unit: mm

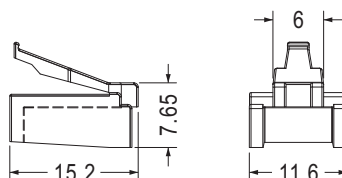

Part No.	Package
PJRA-45	500

RJ-45防塵蓋 RJ45 COVER

用途：用於網路接頭RJ-45防塵與保護。

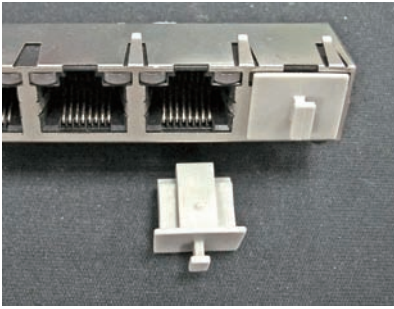

- Material: PE
- Color: Black
- Unit: mm

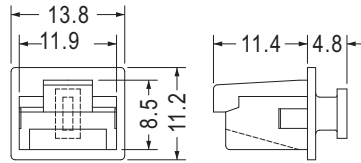

- Color: Black/Gray

Part No.	Package
PJR-45	500

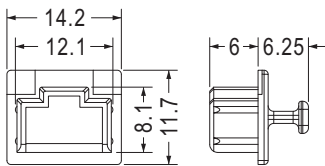

Part No.	Package
PJD-45	1000

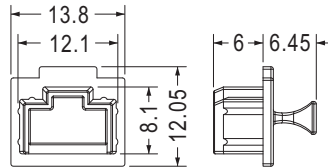

- Material: Nylon 66 (UL)
- Flame Class: 94V-2/94V-0

Part No.	Package
PJD-45-1	1000

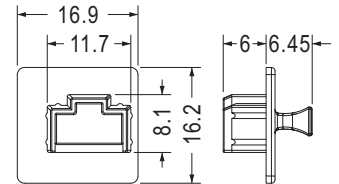

- Material: Nylon 66 (UL)
- Flame Class: 94V-2/94V-0

Part No.	Package
PJD-45-2	1000

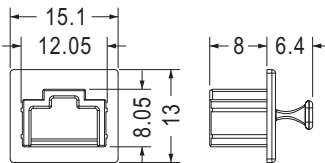

- Material: Nylon 66 (UL)
- Flame Class: 94V-2/94V-0
- Color: Black/Gray

Part No.	Package
PJD-45-4	1000

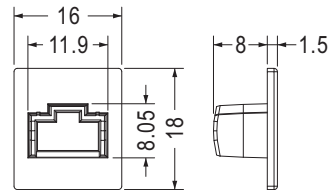

- Material: TPE (UL)
- Flame Class: 94V-0
- Color: Black/Gray

Part No.	Package
PJD-45-5	1000

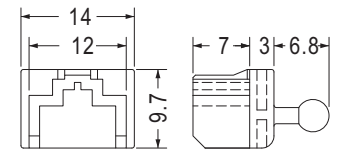

- Material: Nylon 66 (UL)
- Flame Class: 94V-2/94V-0

Part No.	Package
PJV-45	1000

防塵蓋 CONNECTOR COVER

用途：用於CD ROM音源線之防塵與保護。



- Material: PE
- Color: Black
- Unit: mm

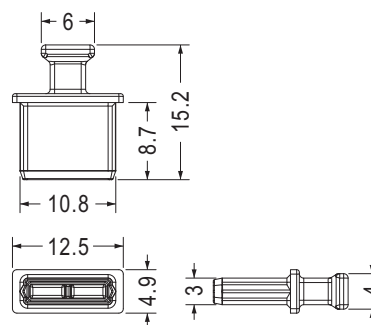

Part No.	Package
CDMCV-1	1000

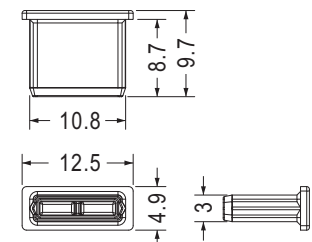

Part No.	Package
CDMCV-2	1000

光纖連接器護套 FIBER OPTIC CONNECTOR COVER

用途：用於光纖接頭PLT130T防塵與保護。



- Material: ABS (UL)
- Flame Class: 94HB
- Color: Black
- Unit: mm

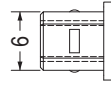
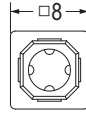
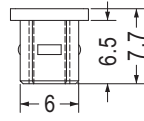

Part No.	Package
OPC-2	1000

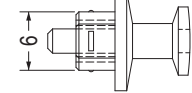
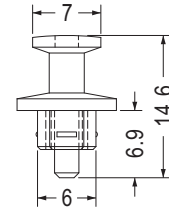

Part No.	Package
OPC-1	1000



- Material: PE
- Color: Black
- Unit: mm

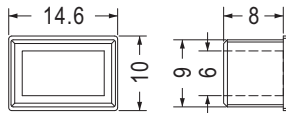
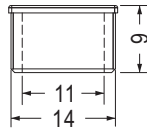

Part No.	Package
SFPC-3	1000

用途：用於光纖接頭防塵與保護。

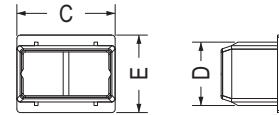
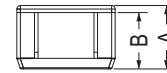

Part No.	A	B	C	D	E	Package
SFPC-13	9.0	8.0	14.0	9.25	11.0	1000
SFPC-17	11.0	10.0	18.5	8.9	10.0	

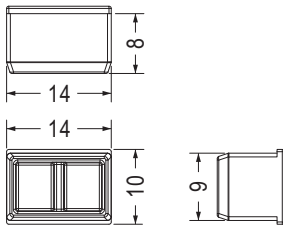

Part No.	Package
SFPC-7	1000

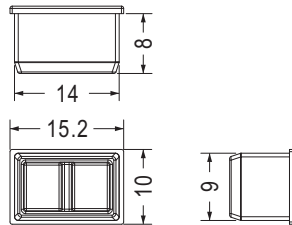

Part No.	Package
SFPC-8	1000

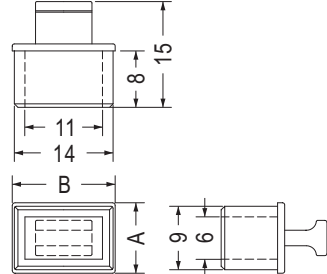

Part No.	A	B	Package
SFPC-1	10.0	14.6	1000
SFPC-10	9.8	14.4	

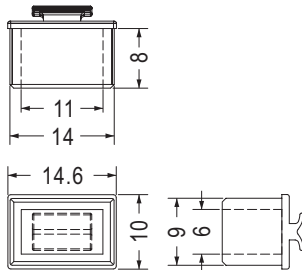

Part No.	Package
SFPC-2	1000

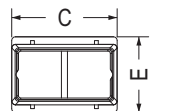
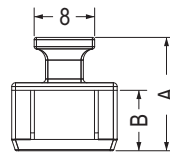

【 SFPC-11, SFPC-12, SFPC-14 】

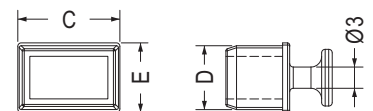
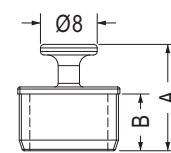

【 SFPC-18 】

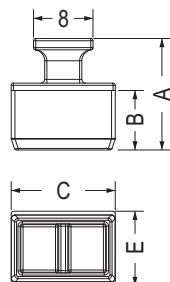

Part No.	A	B	C	D	E	Package
SFPC-4	15.0	8.0	14.0	9.0	10.0	1000
SFPC-5	17.0	10.0	18.5	8.7	10.0	
SFPC-11	15.0	8.0	14.0	9.0	10.0	
SFPC-12	17.0	10.0	18.5	8.9	10.0	
SFPC-14	15.0	8.0	14.0	9.25	11.0	
SFPC-18	15.0	8.0	14.4	9.0	9.8	

光纖連接器護套 FIBER OPTIC CONNECTOR COVER

用途：用於光纖接頭防塵與保護。



- Material: TPE
- Color: Black
- Unit: mm

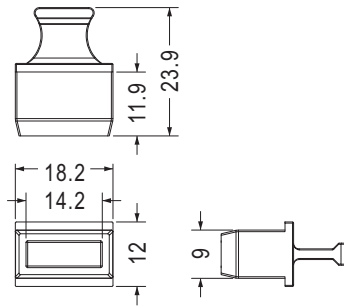

Part No.	Package
SFPC-19	1000

- Material: Nylon 66 (UL)
- Flame Class: 94V-2

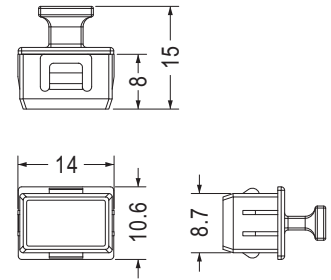

Part No.	Package
SFPC-22	1000



- Material: TPE
- Color: Black
- Unit: mm

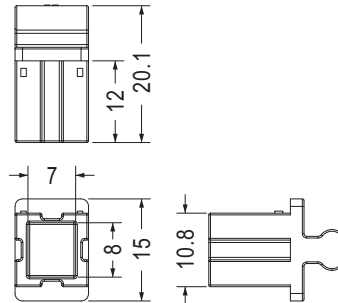

Part No.	Package
SFPC-21	500

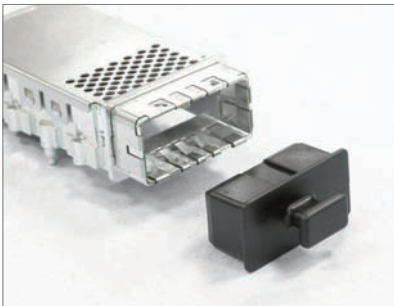

- Material: PE
- Color: Black
- Unit: mm

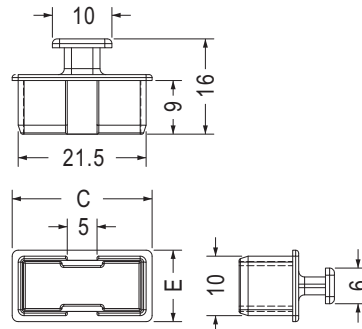

Part No.	C	E	Package
CXP-1	23.5	12.0	1000
CXP-2	22.0	11.0	

- Material: Silicon Rubber (UL)
- Flame Class: 94V-0

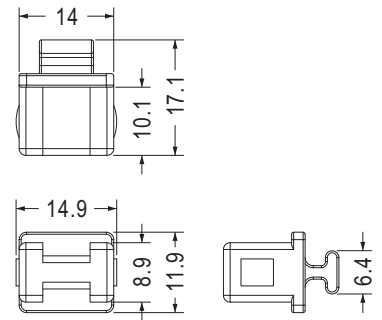

Part No.	Package
SFPC-9	1000

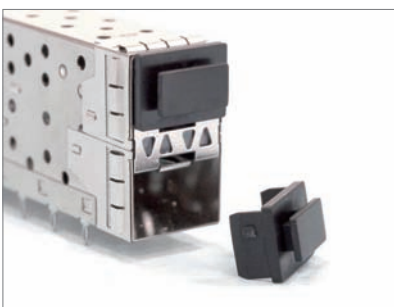

- Material: ABS (UL)
- Flame Class: 94V-0
- Color: Black
- Unit: mm

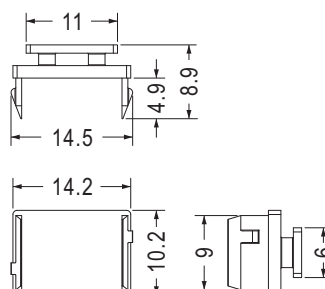

Part No.	Package
SFPC-15	1000

光纖防塵蓋 CONNECTOR COVER

用途：用於光纖座之防塵與保護。



- Material: PE
- Color: Natural
- Unit: mm

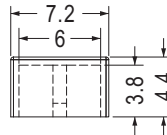
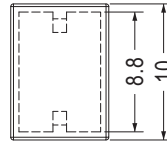

Part No.	Package
COVER-11	1000

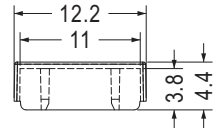
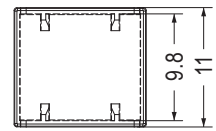

Part No.	Package
COVER-12	1000



- Material: TPE
- Color: Black
- Unit: mm

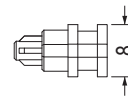
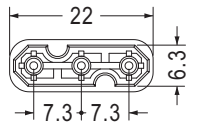
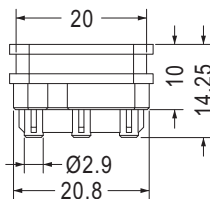

Part No.	Package
COVER-3	1000

SATA防塵蓋 SATA COVER

用途：用於多餘不使用的SATA端子之遮蔽，避免誤用。

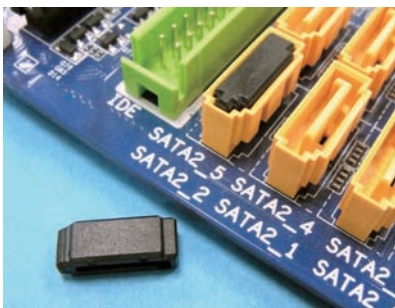

- Material: PE
- Color: Black
- Unit: mm

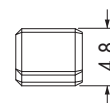
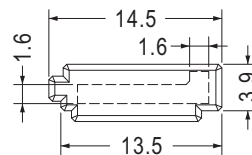
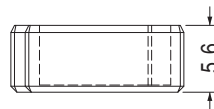

Part No.	Package
CSATA-1	1000



- Material: PE
- Color: Black
- Unit: mm

用途：用於SATA端子之防塵。

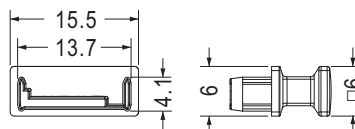
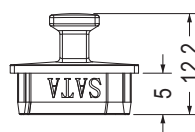

Part No.	Package
SATAC-1	1000

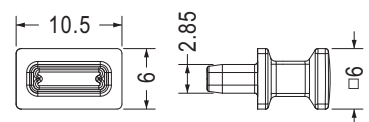
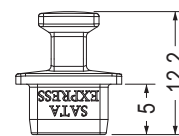

Part No.	Package
SATAC-2	1000

SATA防塵蓋 SATA COVER

用途：用於SATA端子之防塵。

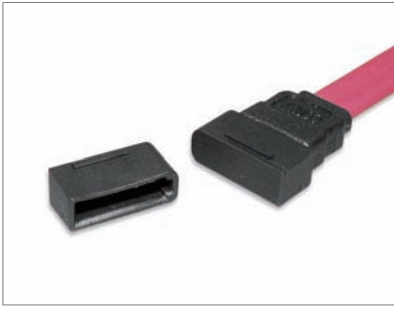

- Material: PE
- Color: Black
- Unit: mm

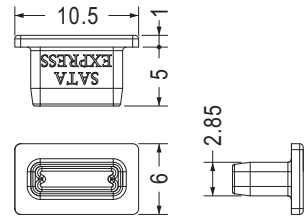
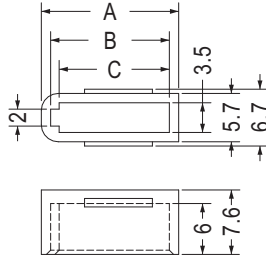

Part No.	A	B	C	Package
SATAC-7	16.2	14.0	13.0	1000
SATAC-15	26.4	24.2	23.2	

Part No.	Package
SATAC-3	1000

SATA防塵蓋 SATA CABLE PLUG COVER

用途：用於SATA端子之防塵蓋。



- Material: PC+ABS (UL)
- Flame Class: 94V-2/94V-0
- Color: Black
- Unit: mm

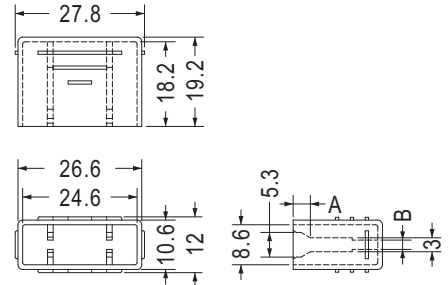
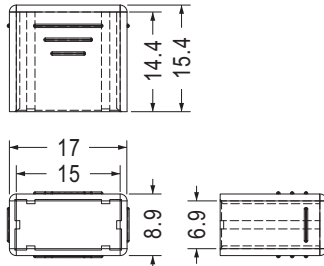

Part No.	Package
CVSATA-15	1000
CVSATA-7	

Part No.	A	B	Package
CVSATA-15	3.7	2.0	500
CVSATA-15S	9.7		



- Material: PC+ABS (UL)
- Flame Class: 94V-0
- Color: Black
- Unit: mm

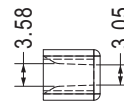
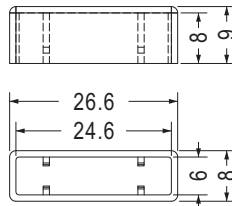

Part No.	Package
CVSATAA-15	500

ESATA護蓋 ESATA COVER

用途：於ESATA上保護插頭，防氧化。



- Material: ABS (UL)
- Flame Class: 94HB
- Color: Black
- Unit: mm

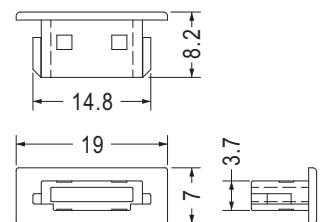
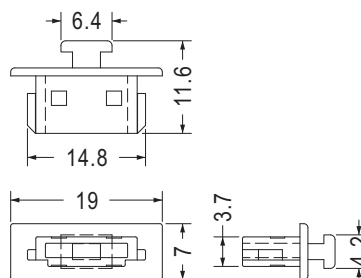

Part No.	Package
ESATA-7	1000

Part No.	Package
ESATA-7-1	1000

防塵蓋 CONNECTOR COVER

用途：用於數位DP端子之防塵蓋、美觀。

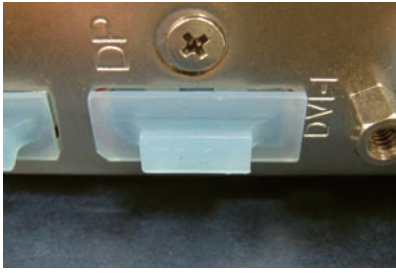

- Material: PE
- Color: Natural/Transparent Blue
- Unit: mm

- Material: PE/Nylon 66 (UL)
- Flame Class: 94V-2/94V-0
- Color: Natural/Black

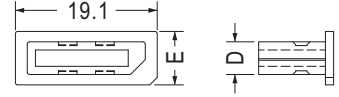
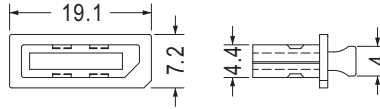
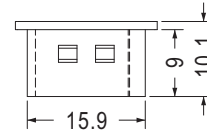
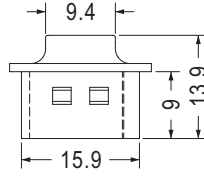

Part No.	Package
DPC-1	1000

Part No.	D	E	Package
DPC-3	4.4	7.2	1000
DPC-3L	4.5	7.4	



- Material: PE
- Color: Black
- Unit: mm

用途：使多餘或無功能的Display Port (DP端子)遮蔽，避免使用者誤插。

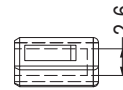
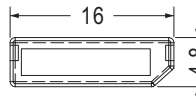
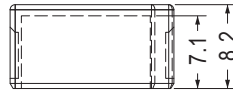

Part No.	Package
DPC-2	1000



- Material: PE
- Color: Natural
- Unit: mm

用途：用於Display Port(DP端子)之防塵與保護。

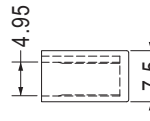
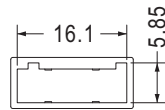
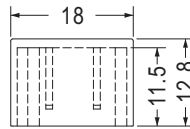

Part No.	Package
KPS-37	1000



- Material: PE
- Color: Natural/Transparent Blue
- Unit: mm

用途：用於Mini DP數位端子之防塵蓋、美觀。

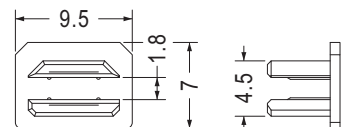
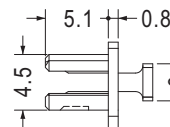
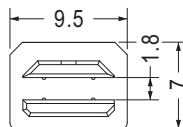
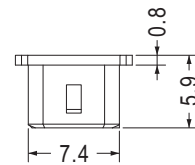
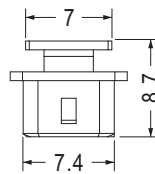

Part No.	Package
MIDP-2	2000

Part No.	Package
★MIDP-4	2000

- Color: Black

防塵蓋 CONNECTOR COVER

用途：用於Mini數位端子之防塵蓋、美觀。



- Material: PE
- Color: Natural/Transparent Blue
- Unit: mm

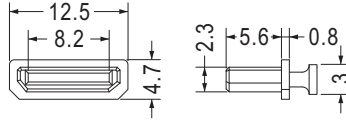
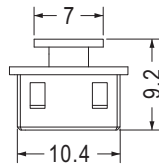

Part No.	Package
MIHDMI-2	2000

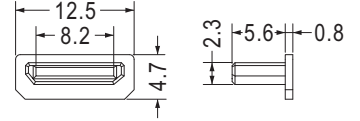
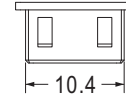

Part No.	Package
MIHDMI-3	2000

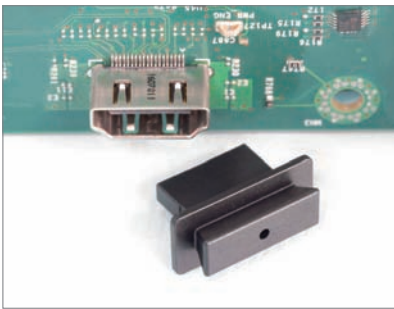

- Material: PE
- Color: Black
- Unit: mm

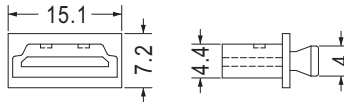
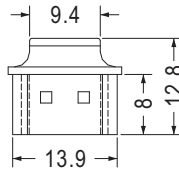

Part No.	Package
HDMIC-1	1000

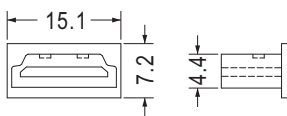
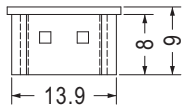

Part No.	Package
HDMIC-2	1000

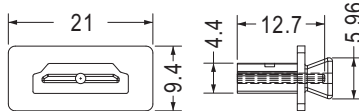
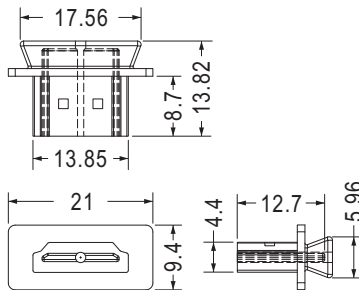

Part No.	Package
HDMIC-10	1000

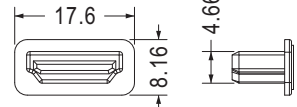
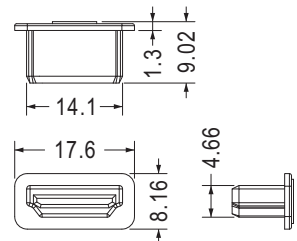

• Material: Rubber

Part No.	Package
HDMIC-11	1000

MICRO HDMI防塵蓋 CONNECTOR COVER

用途：用於Micro HDMI端子座之防塵蓋、美觀。



- Material: TPE
- Color: Black
- Unit: mm

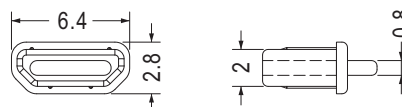
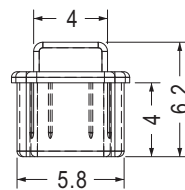

Part No.	Package
HDMIC-8	1000

HDMI防塵蓋 HDMI PORT COVER



- Material: Nylon 66 (UL)
- Flame Class: 94V-2/94V-0
- Color: Natural/Black
- Unit: mm

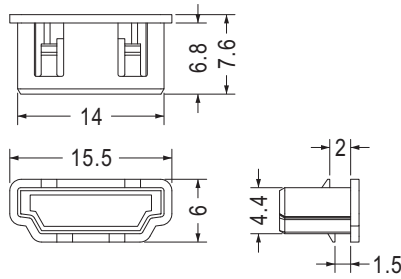

Part No.	Package
HDMIC-3	1000

用途：用於HDMI端子座之防塵、美觀，具有封孔功能，避免錯誤使用拆拔。

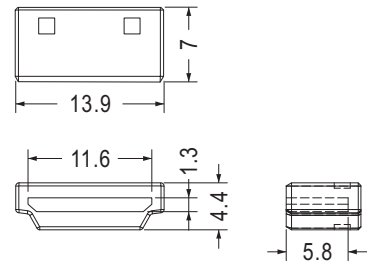

- Material: PE

Part No.	Package
HDMIC-4	1000

HDMI端子蓋 HDMI PLUG COVER



- Material: PE
- Color: Natural
- Unit: mm

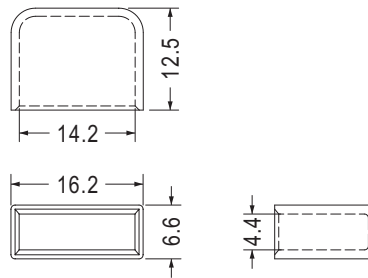

Part No.	Package
HDMIT-1	1000

用途：用於HDMI端子上保護插頭，防氧化。

D.TYPE防塵蓋 D.TYPE CONNECTOR COVER



- Material: PP (UL)
- Flame Class: 94HB
- Color: Natural/Black/Gray
- Unit: mm

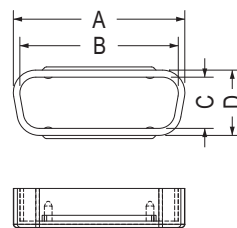

Part No.	A	B	C	D	Package
DTC-9F	18.5	16.5	7.8	10.2	1000
DTC-15F	26.8	24.8	7.8	10.2	500
DTC-25F	40.6	38.6	7.8	10.2	
DTC-9M	20.0	18.0	9.4	11.8	1000
DTC-15M	28.2	26.4	9.4	11.8	500
DTC-25M	42.0	40.0	9.4	11.8	

用途：用於D.Type連接器之防鏽、防塵與保護。



- Material: PP (UL)
- Flame Class: 94HB
- Color: Black/Transparent
- Unit: mm

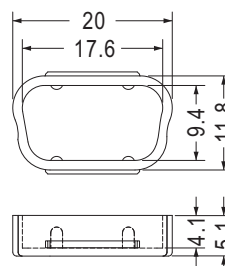

Part No.	Package
DTC-9MS	1000

D.TYPE防塵蓋 D.TYPE CONNECTOR COVER

用途：用於D.TYPE連接器之防鏽、防塵與保護。



- Material: PE
- Color: Natural/Black/Computer
- Unit: mm

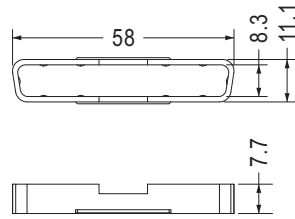

Part No.	Package
DTC-37M	250

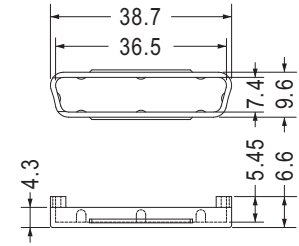

Part No.	Package
DTC-50S	500

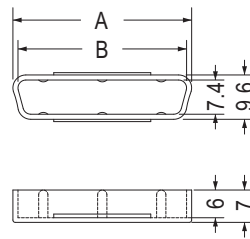

Part No.	A	B	Package
DTC-50M	38.7	36.5	500
DTC-68M	50.2	48.0	

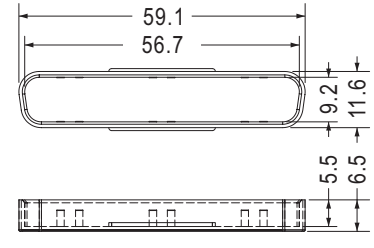

Part No.	Package
DTC-37ML	250



- Material: Nylon 66 (UL)
- Flame Class: 94V-2/94V-0
- Color: Natural/Black
- Unit: mm

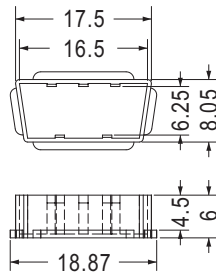

Part No.	Package
DTC-20	1000

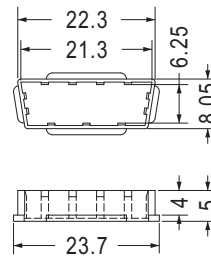

Part No.	Package
DTC-26	1000

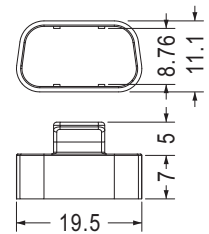

- Color: Black/Gray

Part No.	Package
DTCB-1	500

DVI防塵蓋 CONNECTOR COVER

用途：用於連接器防塵與保護。



- Material: PP (UL)
- Flame Class: 94HB
- Color: Natural/Black
- Unit: mm

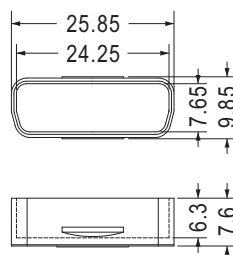

Part No.	Package
DVIC-1	500

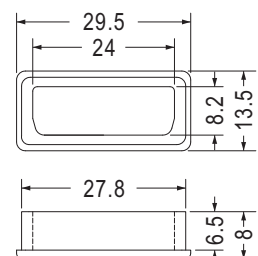

- Material: TPE

Part No.	Package
DVIC-2-N	500

DVI防塵蓋 CONNECTOR COVER

用途：用於連接器防塵與保護。



- Material: PE
- Color: Black
- Unit: mm

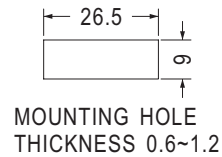
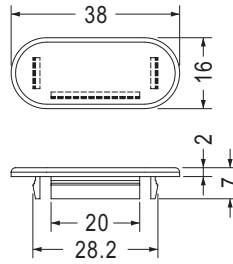

Part No.	Package
DVI-1	500



- Material: Nylon 66 (UL)
- Flame Class: 94V-2/94V-0
- Color: Natural/Black
- Unit: mm

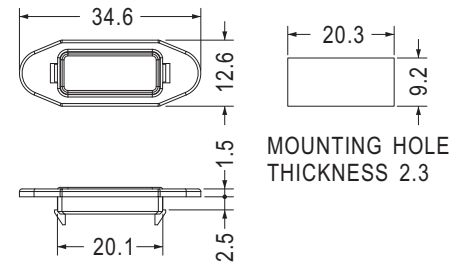
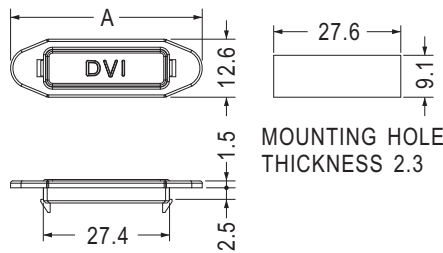

Part No.	A	Package
DVI-2	41.6	1000
DVI-4	38.6	

Part No.	Package
DVI-3	1000

VGA防塵蓋 CONNECTOR COVER

用途：VGA端子之防塵蓋、美觀。



- Material: PP (UL)
- Flame Class: 94HB
- Color: Natural/Transparent
- Unit: mm

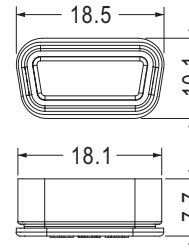

Part No.	Package
VGAC-1	500

防塵蓋 CONNECTOR COVER

用途：用於防塵與保護用。



- Material: Nylon 66 (UL)
- Flame Class: 94V-2/94V-0
- Color: Natural/Black
- Unit: mm

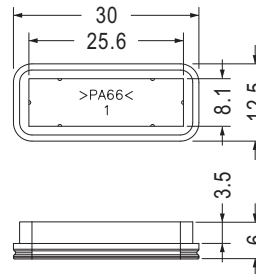

Part No.	Package
PCIEC-1	1000



- Material: PC (UL)
- Flame Class: 94V-0
- Color: Transparent
- Unit: mm

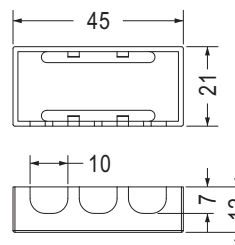

Part No.	Package
COVER-25	200

防塵蓋 CONNECTOR COVER

用途：用於連接器防塵與保護。



- Material: Nylon 66 (UL)
- Flame Class: 94V-2/94V-0
- Color: Natural/Black
- Unit: mm

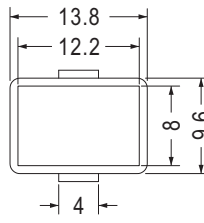

Part No.	Package
VGAB-1	1000

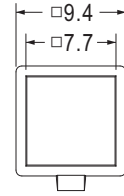

Part No.	Package
VGAB-2	1000

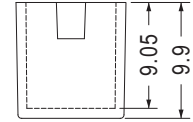
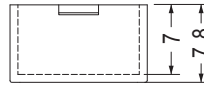

- Material: PE
- Color: Black
- Unit: mm

用途：用於汽車連接器防塵與保護。

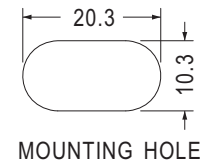
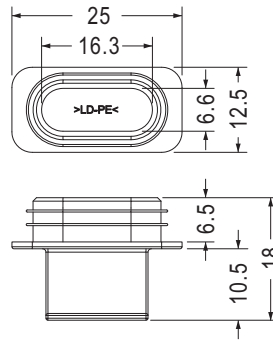

Part No.	Package
CVA-5	1000

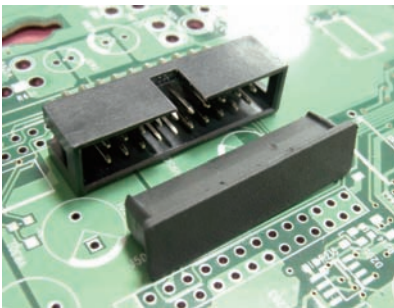

- Material: PE
- Color: Black
- Unit: mm

用途：用於IDE Connector防塵與保護。

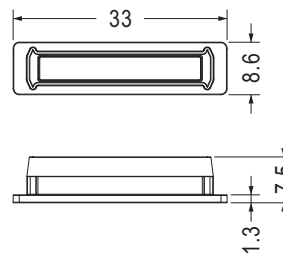

Part No.	Package
DKCV-1	500



- Material: NBR
- Color: Black
- Unit: mm

用途：用於SFP連接器防塵與保護用。

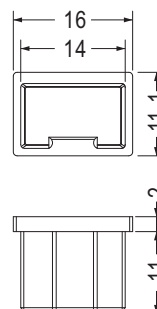

Part No.	Package
TF-246	1000

防塵蓋 CONNECTOR COVER

用途：用於連接器防塵與保護。

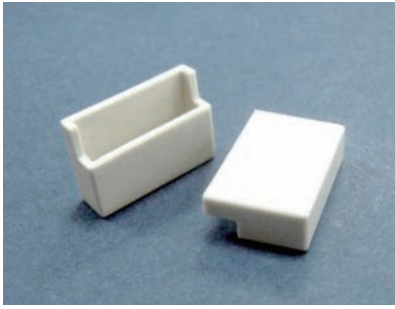

- Material: PBT (UL)
- Flame Class: 94V-0
- Color: Natural
- Unit: mm

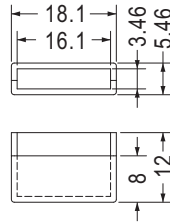

Part No.	Package
COVER-4	500

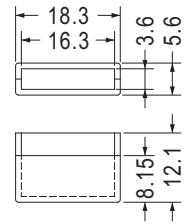

Part No.	Package
COVER-7	500

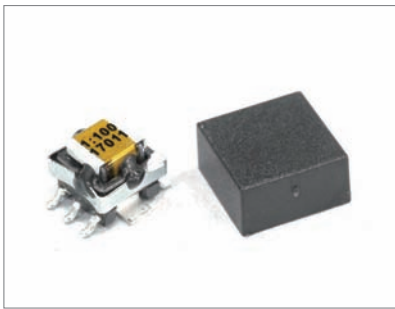

- Material: Nylon 66 (UL)
- Flame Class: 94V-2/94V-0
- Color: Natural/Black
- Unit: mm

用途：用於電子零件晶體之防塵與保護。

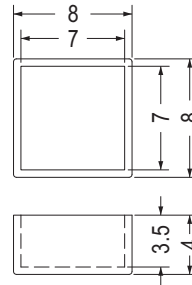

Part No.	Package
COVER-14	1000



- Material: Nylon 66 (UL)
- Flame Class: 94V-2/94V-0
- Color: Natural/Black
- Unit: mm

用途：用於防塵與保護用。

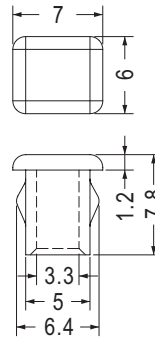

Part No.	Package
COVER-6	1000



- Material: Nylon 66 (UL)
- Flame Class: 94V-2/94V-0
- Color: Natural/Black
- Unit: mm

用途：用於PC250端子防塵蓋。

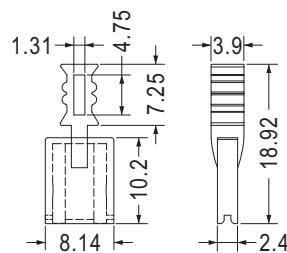

Part No.	Package
CVP-250	1000

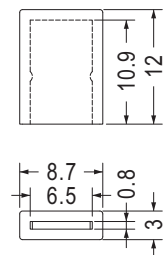

- Material: PE

Part No.	Package
KPS-42	1000

1394端子防塵蓋 CONNECTOR COVER

用途：用於1394接頭防塵與保護。



- Material: PE
- Color: Black
- Unit: mm

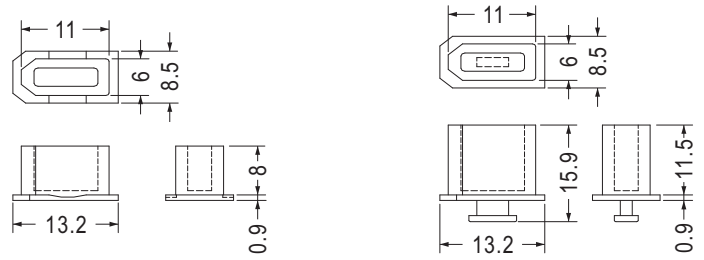

Part No.	Package
CVR-1394	1000

Part No.	Package
CVR-1394S	1000



- Material: PP (UL)
- Flame Class: 94HB
- Color: Gray
- Unit: mm

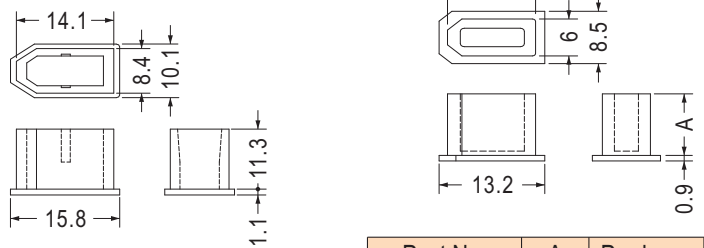

Part No.	Package
CVR-1394-1	1000

Part No.	A	Package
CVR-1394-2	10.0	1000
CVR-1394-3	11.5	



- Material: PE
- Color: Black/Computer
- Unit: mm

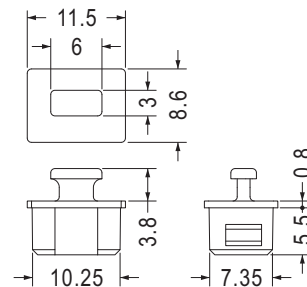

Part No.	Package
CVRB-1394	1000

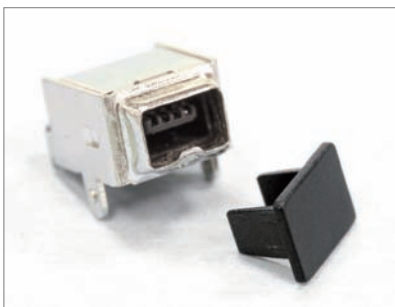

- Material: ABS (UL)
- Flame Class: 94HB
- Color: Black
- Unit: mm

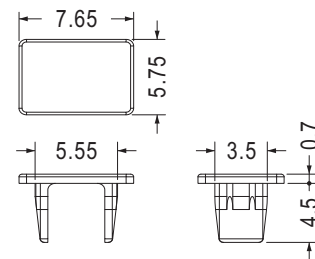

Part No.	Package
CVRD-1394	1000

端子防塵蓋 CONNECTOR COVER

用途：做為端子之防塵與保護。



- Material: TPE
- Color: Black
- Unit: mm

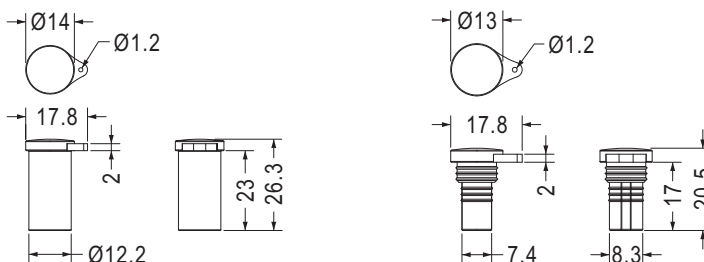

Part No.	Package
SCCVA-3	1000

Part No.	Package
SCCVA-4	1000

電源插頭防塵蓋 POWER CONNECTOR COVER

用途：保護電源插頭之防塵、防氧化。



- Material: PE
- Color: Natural
- Unit: mm

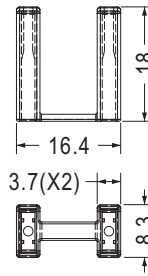

- Material: PP

Part No.	Package
PLCC-14	250

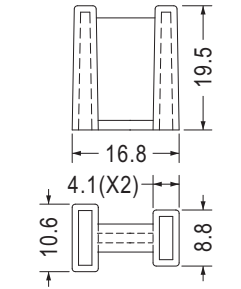

Part No.	Package
PLCC-1	500

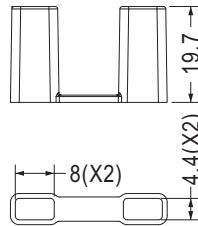

Part No.	Package
PLCC-8	1000

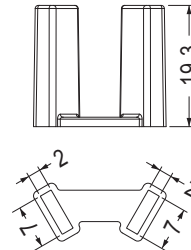

Part No.	Package
PLCC-9	1000

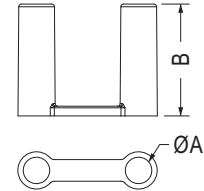

Part No.	A	B	Package
PLCC-10	4.9	20.7	1000
PLCC-11	4.1	20.7	
PLCC-20	5.3	18.0	

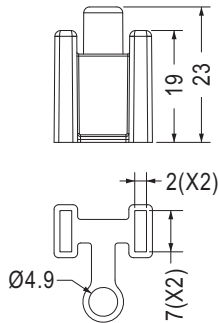

Part No.	Package
PLCC-13	500

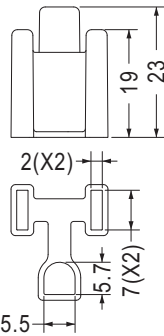

Part No.	Package
PLCC-18	500

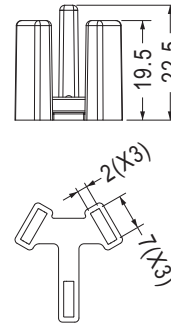

Part No.	Package
PLCC-15	1000

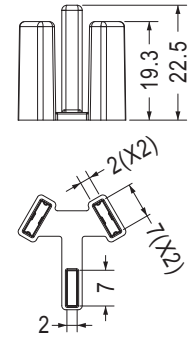

Part No.	Package
PLCC-19	1000

插頭保護座 SOCKET COVER

用途：用於電源插座後端，防短路、保護用。



- Material: Nylon 66 (UL)
- Flame Class: 94V-2/94V-0
- Color: Black
- Unit: mm

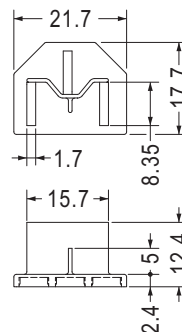

Part No.	Package
PLCD-1	500

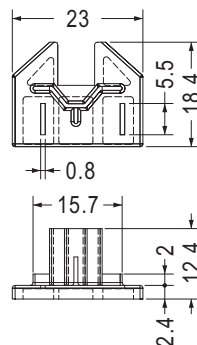

Part No.	Package
PLCD-2	500

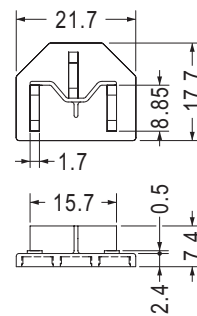

Part No.	Package
PLCD-3	500

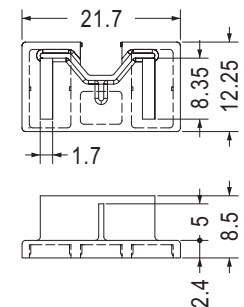

Part No.	Package
PLCD-4	500

電源插座防塵蓋 POWER CONNECTOR COVER

用途：用於三插電源座防塵與保護。



- Material: ABS (UL)
- Flame Class: 94HB
- Color: Black
- Unit: mm

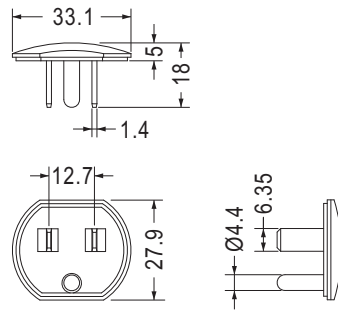

Part No.	Package
PLCC-2	500



- Material: PP
- Color: White
- Unit: mm

用途：用於兩插電源座防塵與保護。

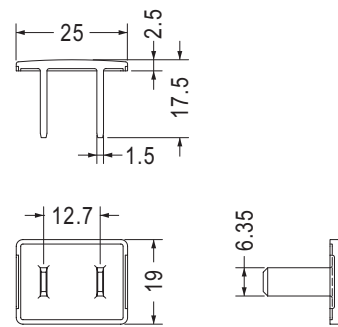

Part No.	Package
PLCC-3	500

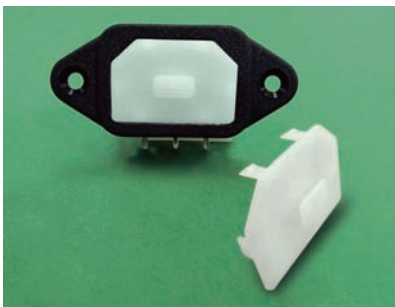

- Material: Nylon 66 (UL)
- Flame Class: 94V-2/94V-0
- Color: Natural/Black
- Unit: mm

用途：用於電源座之防塵與保護。

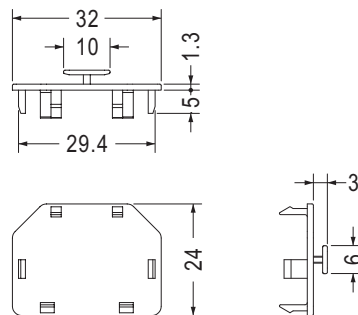

Part No.	Package
PLCC-5	500



- Material: PE
- Color: Black
- Unit: mm

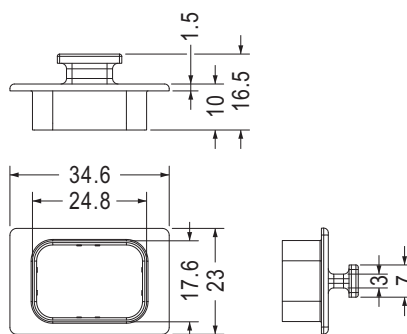

Part No.	Package
PLCC-16	500

電源插座防塵蓋 POWER CONNECTOR COVER

用途：用於電源插座接頭防塵與保護。



- Material: PE
- Color: Black/Yellow
- Unit: mm

- Material: TPE (UL)
- Flame Class: 94V-0
- Color: Black
- Unit: mm

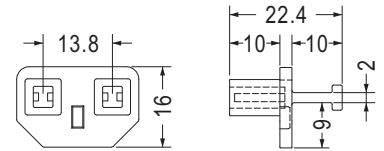
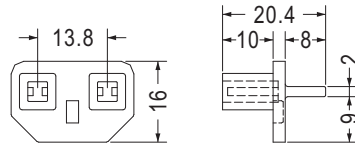
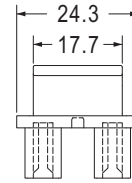
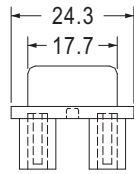

Part No.	Package
PLC-1	250

Part No.	Package
PLC-3	250



- Material: Nylon 66 (UL)
- Flame Class: 94V-2/94V-0
- Color: Natural/Black
- Unit: mm

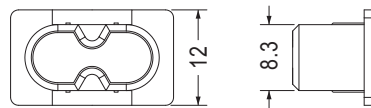
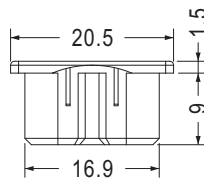

Part No.	Package
PLC-2	500

7

防塵蓋 IP CONNECTOR HOUSING

用途：用於機板上，保護電源插座避免刮傷。



- Material: Nylon 66 (UL)
- Flame Class: 94V-2/94V-0
- Color: Natural/Black
- Unit: mm

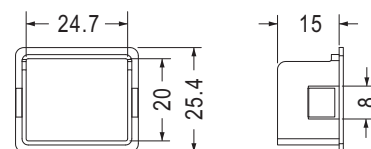
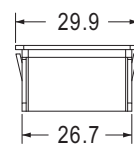

Part No.	Package
PLCC-7	1000

零件蓋 CONNECTOR COVER

用途：用於零件之防塵與保護。



- Material: ABS (UL)
- Flame Class: 94HB
- Color: Black
- Unit: mm

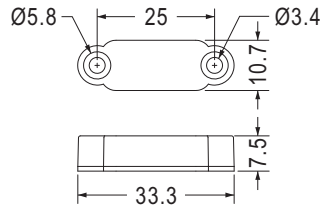

Part No.	Package
CVR-2508	1000

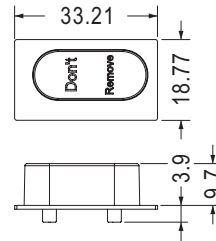

Part No.	Package
CVR-3318	1000

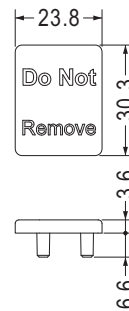

Part No.	Package
CVR-3325	1000

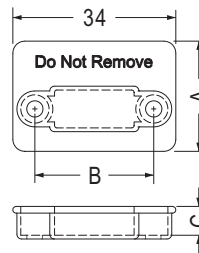

Part No.	A	B	C	Package
CVR-3421	21.5	25.0	5.8	1000
CVR-3423	23.0	24.8	6.0	

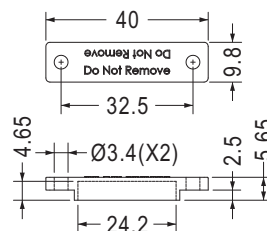

Part No.	Package
CVR-4098	500

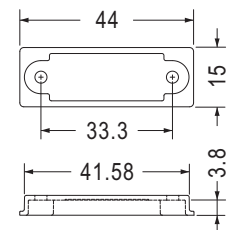

Part No.	Package
CVR-4415	1000

防塵蓋 CONNECTOR COVER

用途：用於連接器防塵與保護。



- Material: ABS (UL)
- Flame Class: 94HB
- Color: Black
- Unit: mm

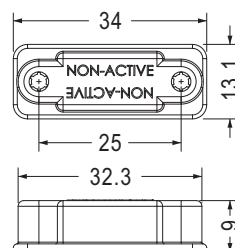

Part No.	Package
CVR-3413-1	500

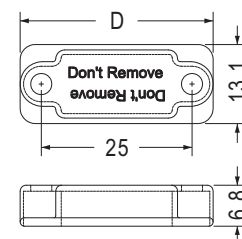

Part No.	D	Package
CVR-3213	32.0	1000
CVR-3413	34.0	

防塵蓋 CONNECTOR COVER

用途：用於防塵與保護。



- Material: ABS (UL)
- Flame Class: 94HB
- Color: Black
- Unit: mm

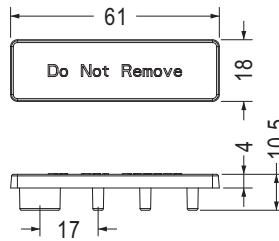

Part No.	Package
CVR-6118	500

電源蓋 POWER SUPPLY CAP

用途：用於電源線之固定與保護，避免脫落。

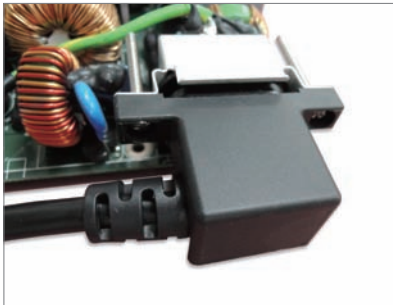

- Material: Nylon 66 (UL)
- Flame Class: 94V-2/94V-0
- Color: Natural/Black
- Unit: mm

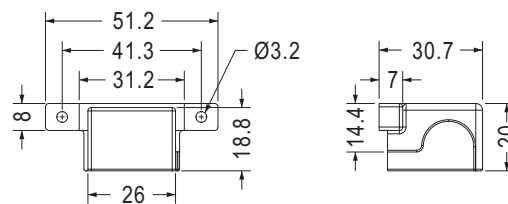

Part No.	Package
CVA-8	500

防塵蓋 CONNECTOR COVER

用途：用於防塵與保護用。



- Material: Nylon 66 (UL)
- Flame Class: 94V-2/94V-0
- Color: Natural/Black
- Unit: mm

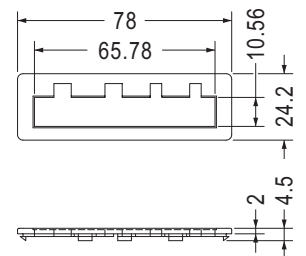
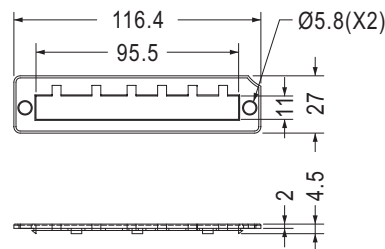

Part No.	Package
PCIE-1	500

Part No.	Package
PCIE-2	500

機板電源保護蓋 POWER CONNECTOR COVER

用途：保護主機板電源端子，防塵與美觀。

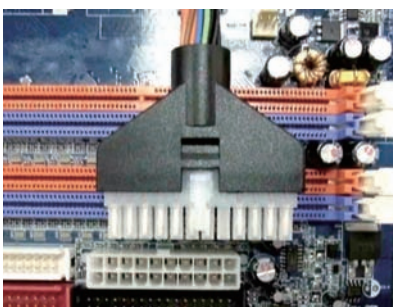

- Material: PE
- Color: Black
- Unit: mm

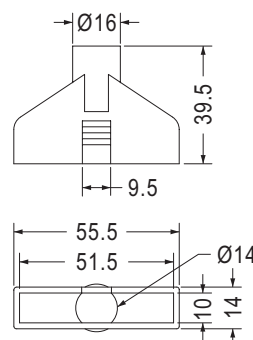

Part No.	Package
STAT-CV24	250

連接器防塵蓋 CONNECTOR COVER

用途：用於連接器防塵與保護。

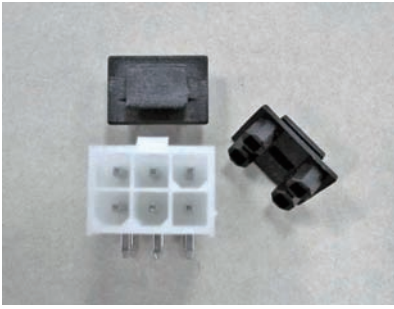

- Material: PP
- Color: Black
- Unit: mm

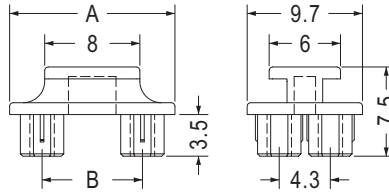

Part No.	A	B	Package
PWIC-6	13.9	8.4	500
PWIC-8	18.0	12.7	

連接器座 CONNECTOR HOUSING

用途：用於連接器之保護。

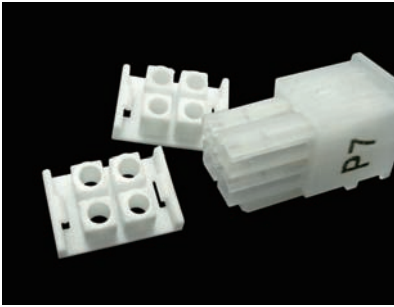

- Material: Nylon 66 (UL)
- Flame Class: 94V-2/94V-0
- Color: Natural/Black
- Unit: mm

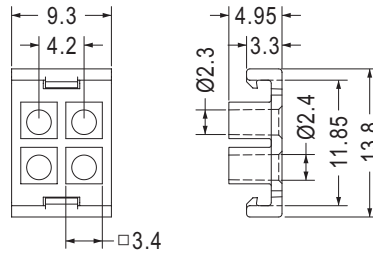

Part No.	Package
012-958	1000

耳機孔護套 HEADPHONE JACK DUST PLUG

用途：用於3.5 mm耳機孔，防塵與保護。



- Material: Nylon 66 (UL)
- Flame Class: 94V-2/94V-0
- Color: Natural/Black
- Unit: mm

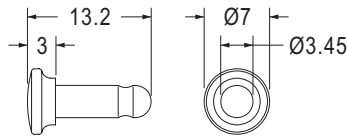

插入耳機孔會啟動靜音模式
Activates silent mode function,
when plug into headphone jack.

Part No.	Package
MHSC-1	2000

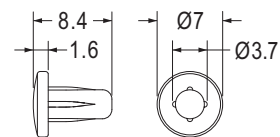

- Material: PP
- Color: Black

Part No.	Package
MHSC-2	2000

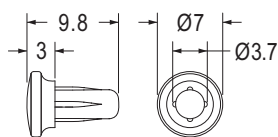

Part No.	Package
MHSC-3	2000

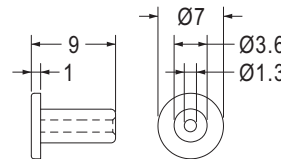

Part No.	Package
MHSC-4	2000

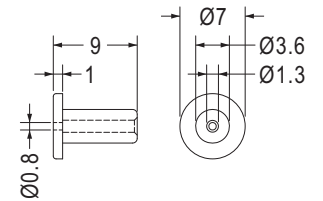

Part No.	Package
MHSC-4-1	2000

耳機孔護套 HEADPHONE DUST PLUG

用途：用於3.5 mm耳機孔，防塵與保護。



- Material: TPE
- Color: Black
- Unit: mm

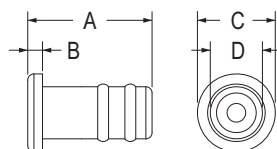

Part No.	A	B	C	D	耳機孔	Package
MHSC-5	8.0	0.95	5.0	3.35	Ø3.5	2000
MHSC-6	6.0	1.0	4.2	2.2	Ø2.5	

Ø3.5音源線防塵蓋 Ø3.5 mm AUDIO COVER

用途：用於Ø3.5 mm音源線防塵與保護。



- Material: PP
- Color: Natural
- Unit: mm

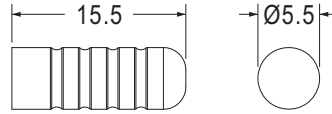

Part No.	Package
EARC-3.5	2000

防塵蓋 CONNECTOR COVER

用途：用於PC板金手指防塵與保護。

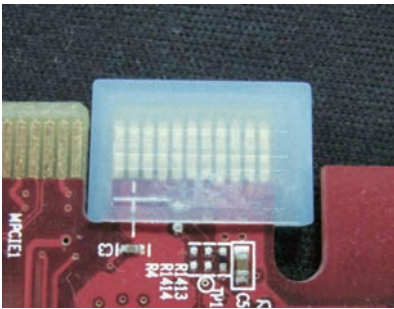

- Material: PE
- Color: Natural/Transparent Blue
- Unit: mm

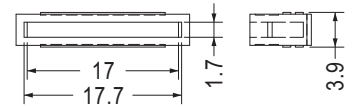
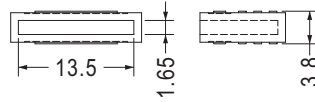
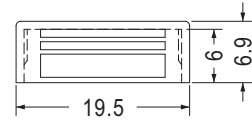
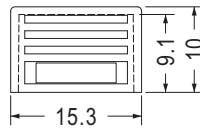

Part No.	Package
GDFC-13	2000

Part No.	Package
GDFC-17	2000

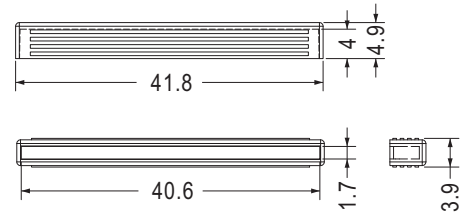
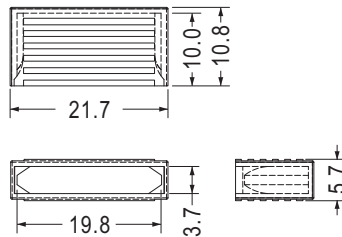
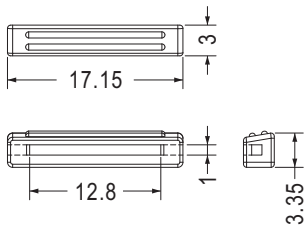

- Material: Nylon 66 (UL)
- Flame Class: 94V-2/94V-0
- Color: Blue

- Color: Yellow

Part No.	Package
GDFC-14	2000

Part No.	Package
GDFC-20	1000

Part No.	Package
GDFC-40	1000

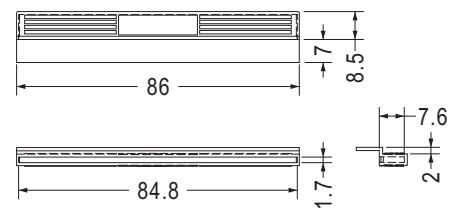
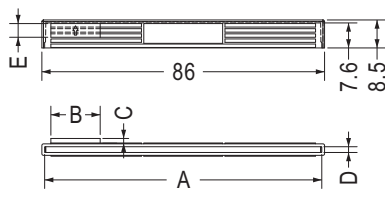

Part No.	A	B	C	D	E	Package
GDFC-83	84.31	15.0	1.43	1.75	4.16	500
GDFC-84	84.8	/	/	1.7	/	

Part No.	Package
GDFC-84-2N	1000

防塵蓋 CONNECTOR COVER

用途：用於PC板金手指防塵與保護。

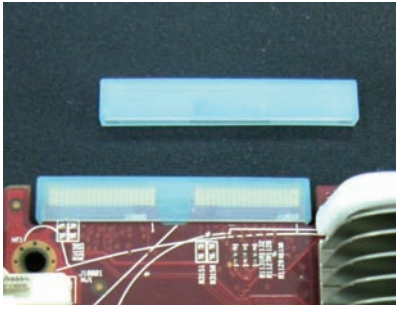

- Material: PE
- Color: Black/Transparent Bule
- Unit: mm

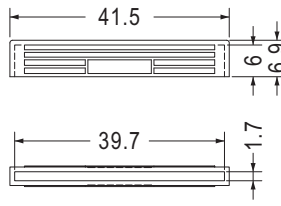

Part No.	Package
GDFC-39	1000

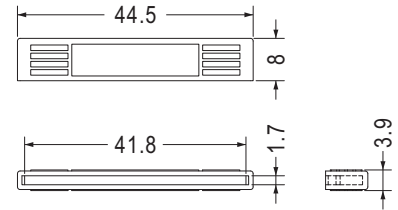

Part No.	Package
GDFC-42	500

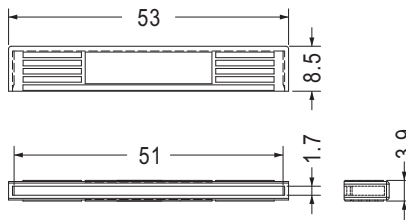
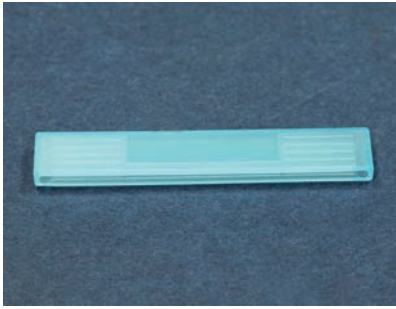

Part No.	Package
GDFC-51	500

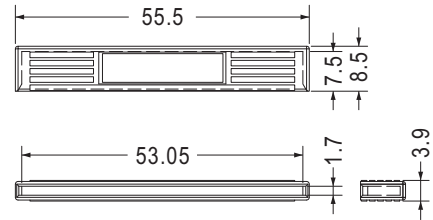

Part No.	Package
GDFC-53	500



- Material: PC+ABS (UL)
- Flame Class: 94V-0
- Color: Orange
- Unit: mm

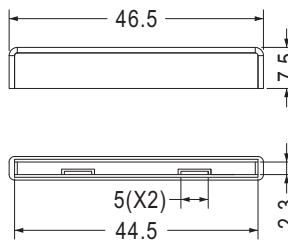

Part No.	Package
HANE-63	1000



- Material: PE
- Color: Bule
- Unit: mm

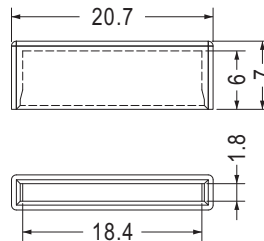

Part No.	Package
GDFC-18N	1000

防塵套 CONNECTOR COVER

用途：用於PC板金手指之絕緣與防塵。

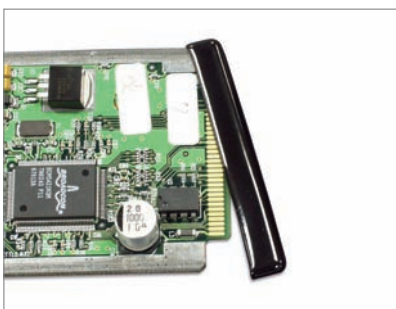

- Material: Soft P.V.C
- Color: Black
- Unit: mm

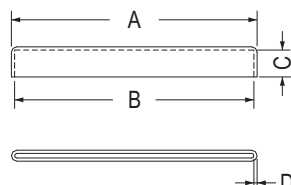

THICKNESS 1.7~1.8

Part No.	A	B	C	D	Package
FHCV-52	51.8	49.8	11.5	1.0	1000
FUSE-5	65.9	63.5	7.0	1.2	
FUSE-6	91.4	89.0	10.0	1.2	

連接器座 CONNECTOR HOLDER

用途：用於連接器防塵與保護。

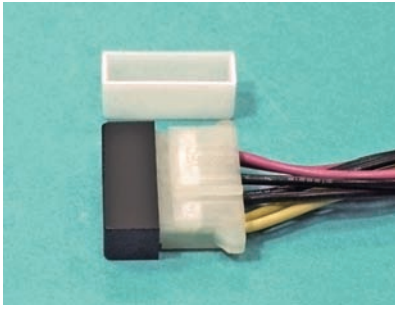

- Material: Nylon 66 (UL)
- Flame Class: 94V-2/94V-0
- Color: Natural/Black
- Unit: mm

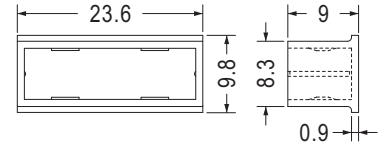
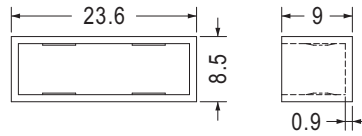

Part No.	Package
FHC-1	500

Part No.	Package
FHC-2	500

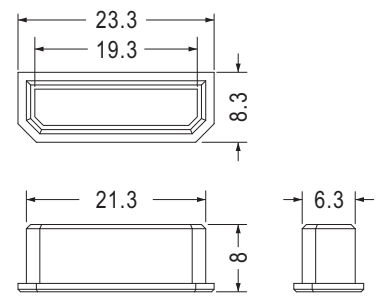
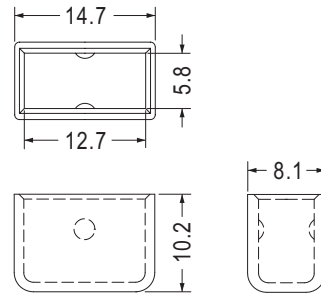
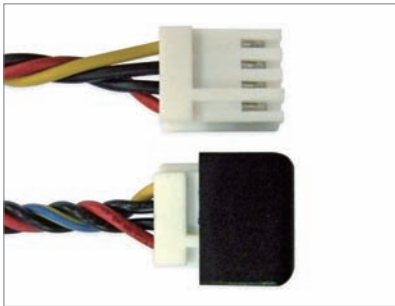

Part No.	Package
FHC-3	1000

Part No.	Package
FHC-4	500

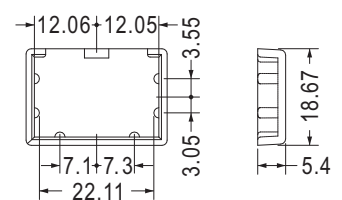
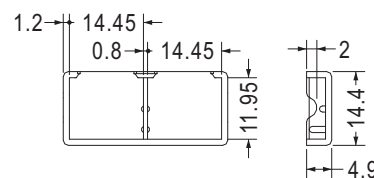
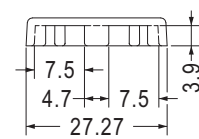
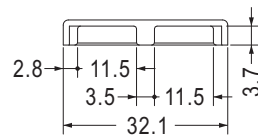
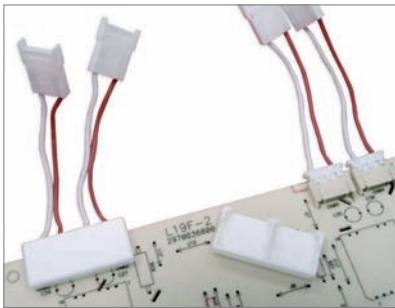

Part No.	Package
CDELT-2	500

Part No.	Package
CDELT-3	500

防塵蓋 CONNECTOR COVER

用途：用於連接器防塵與保護。



- Material: PBT (UL)
- Flame Class: 94V-0
- Color: Natural
- Unit: mm

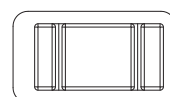
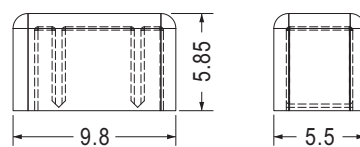

Part No.	Package
FHCA-1	1000

PCMIC卡保護蓋 PCMIC CARD SOCKET COVER

用途：用於PCMIC卡保護用。



- Material: ABS (UL)
- Flame Class: 94HB
- Color: Black/White
- Unit: mm

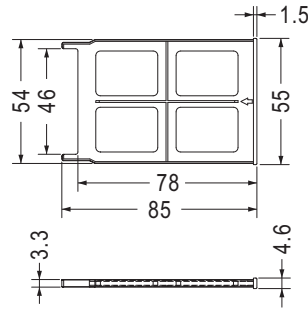

Part No.	Package
PCMIC-1	100

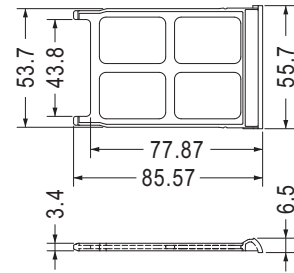

Part No.	Package
PCMIC-2	100

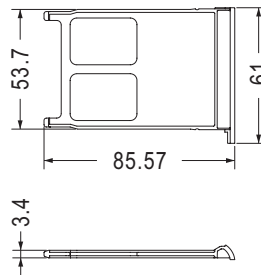

Part No.	Package
PCMIC-3	100

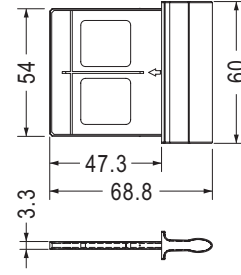

Part No.	Package
PCMIC-4	100

面板 CARD BEZEL

用途：用於IC卡讀卡機之面板。



- Material: PC+ABS (UL)
- Flame Class: 94V-0
- Color: Black
- Unit: mm

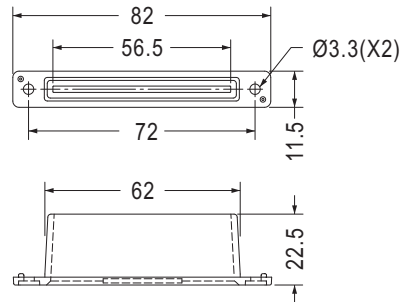

Part No.	Package
CRDCV-56	100

DDR防塵蓋 DDR COVER

用途：用於DDR記憶體之防塵。



- Material: PC+ABS (UL)
- Flame Class: 94V-0
- Color: Black
- Unit: mm

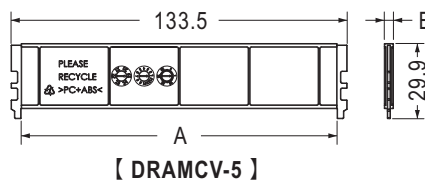

【 DRAMCV-5 】

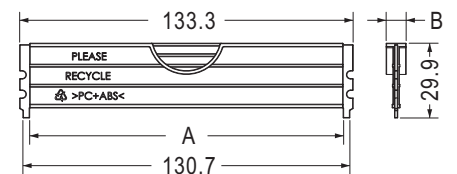

Part No.	A	B	For	Package
DRAMCV-2	125.5	8.0	DDR3	50
DRAMCV-4	125.3	8.0	DDR4	
DRAMCV-4S	125.3	7.5	DDR5	80
DRAMCV-5	125.5	3.65		

DRAM固定帶 DRAM FIXATION STRAP

用途：用於DRAM記憶卡固定。

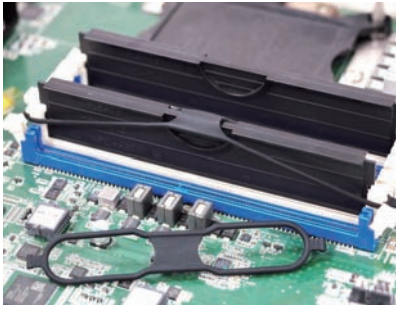

- Material: Silicon Rubber
- Color: Black
- Unit: mm

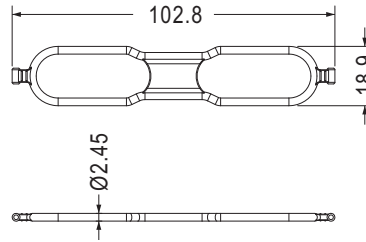

使用說明
Installation Step

Part No.	Package
DRLC-1I	100

D-SUB保護蓋 D-SUB COVER

用途：用於D-SUB之保護用。



- Material: PC+ABS (UL)
- Flame Class: 94V-0
- Color: Black
- Unit: mm

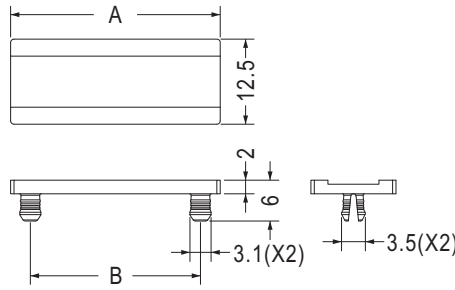

Part No.	A	B	Package
CVR-3012	30.8	25.0	1000
CVR-5312	53.0	47.0	500
CVR-6912	69.3	63.5	

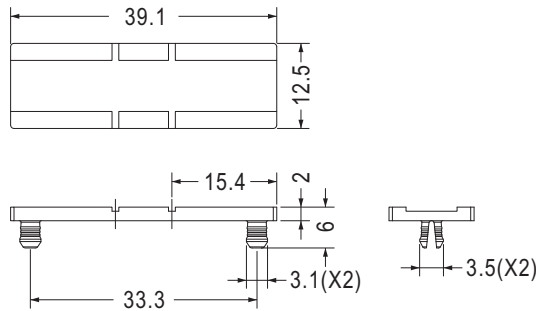

Part No.	Package
CVR-3912	500

高壓防塵蓋 PLASTIC COVER

用途：用於開關電源高壓部分，防止蟑螂入侵，避免造成短路，可做為絕緣及防塵、保護用。
(可依客戶PC板另外客製開模設計)



- Material: Nylon 66 (UL)
- Flame Class: 94V-2/94V-0
- Color: Natural/Black
- Unit: mm

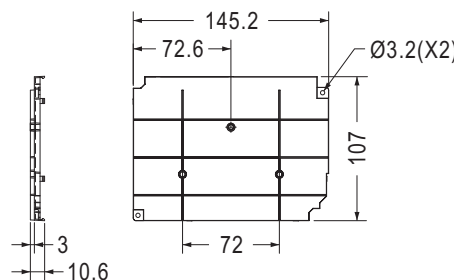

Part No.	Package
CV145107	500

SD卡保護蓋 SD CARD SOCKET COVER

用途：用於SD卡保護用。



- Material: ABS (UL)
- Flame Class: 94HB
- Color: Black
- Unit: mm

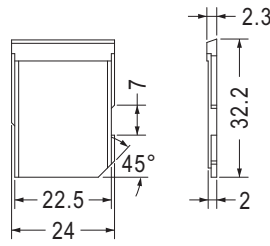

Part No.	Package
SD-24	500

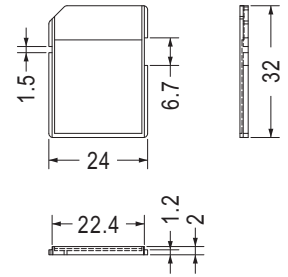

Part No.	Package
SD-25	500

SIM卡保護蓋 SIM CARD SOCKET COVER

用途：SIM卡之防塵與保護。



- Material: PC
- Color: Black
- Unit: mm

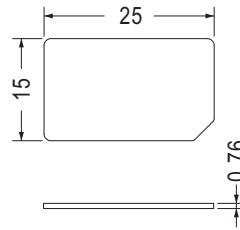

Part No.	Package
FR2515N	1000

MICRO SD卡保護蓋 CARD SOCKET COVER

用途：用於Micro Sd卡保護用。



- Material: PC+ABS (UL)
- Flame Class: 94V-2
- Color: Black
- Unit: mm

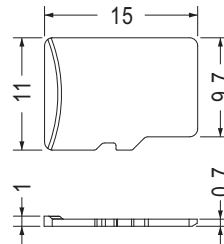

Part No.	Package
MIOSD-1	1000

防塵蓋 CONNECTOR COVER

用途：用於塑膠機殼螺絲孔之塞頭。



- Material: Nylon 66 (UL)
- Flame Class: 94V-2/94V-0
- Color: Natural/Black
- Unit: mm

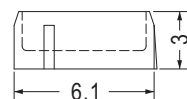
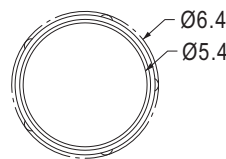

Part No.	Package
CAPX-6	2000

開關蓋 SWITCH COVER

用途：用於開關保護用。



- Body Material: Nylon 66 (UL)
- Cover Material: PC (UL)
- Flame Class: 94V-2/94V-0
- Color: Black
- Unit: mm

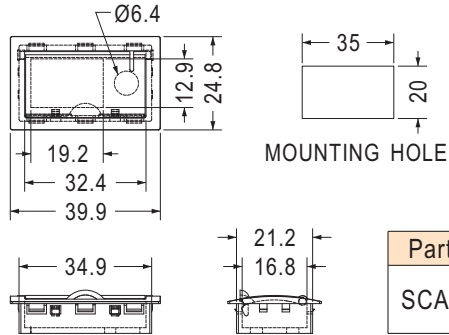

Part No.	Part No.	Package
SCAB-2F	SCAB-2A SCAB-2B	21



- Material: Nylon 66 (UL)
- Flame Class: 94V-2/94V-0
- Color: Natural/Black
- Unit: mm

用途：用於開關之按鍵。

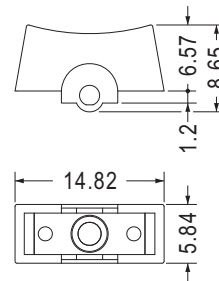

Part No.	Package
TSC-29	1000

開關遮板 SWITCH COVER

用途：用於開關蓋保護用。



- Material: ABS (UL)
- Flame Class: 94HB
- Color: Black
- Unit: mm

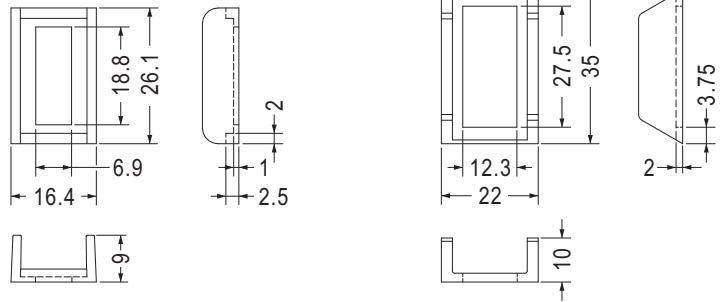

Part No.	Package
SCAB-7	500

Part No.	Package
SCAB-12	500



- Material: Nylon 66 (UL)
- Flame Class: 94V-2/94V-0
- Color: Black
- Unit: mm

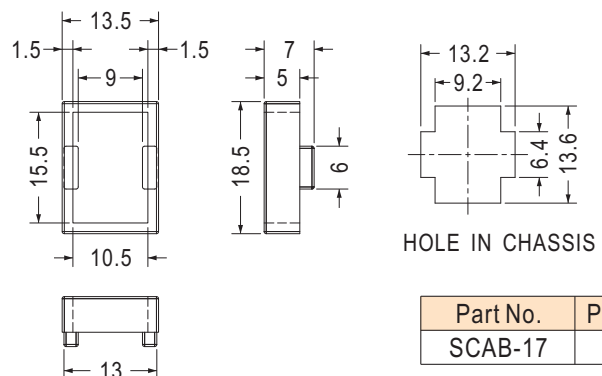

Part No.	Package
SCAB-17	500

尼龍鉚釘 SNAP RIVET

用途：用於PC板、鐵板零件固定，代替螺絲，省時不需工具，結合力強。



- Material: Nylon 66 (UL)
- Flame Class: 94V-2/94V-0
- Color: Natural/Black
- Unit: mm

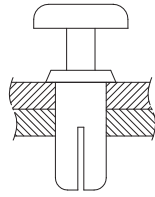
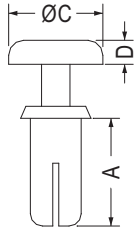

MOUNTING HOLE: ØG
THICKNESS: T

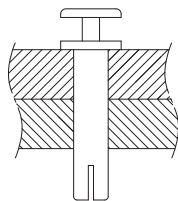
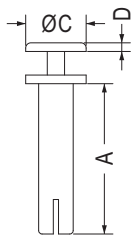

MOUNTING HOLE: ØG
THICKNESS: T

【 SR2-4, SR2-5, SR2-6, SR2-7, SR2-9 】

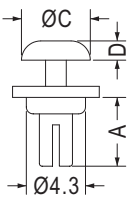

MOUNTING HOLE: ØG
THICKNESS: T

【 SR2.5-5.8 】

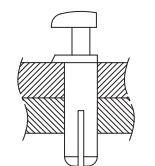
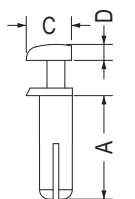

MOUNTING HOLE: ØG
THICKNESS: T

【 SR3.5-11D 】

Part No.	A	C	D	G	T	Package
SR2-2.4	2.4	4.2	1.2	2.0	0.6~1.2	1000
SR2-3.2	3.2	4.2	1.2	2.0	1.3~2.0	2000
SR2-3.2S	3.2	4.2	1.2	2.0	1.3~1.9	
SR2-4	4.0	3.5	0.5	2.0	2.3~2.5	1000
SR2-5	5.0	4.8	0.75	2.0	2.5~3.5	
SR2-5.6	5.6	4.2	1.2	2.0	3.7~4.4	
SR2-6	6.0	4.8	0.75	2.0	3.5~4.5	
SR2-6.4	6.4	4.2	1.2	2.0	4.5~5.2	
SR2-7	7.0	4.8	0.75	2.0	4.5~5.5	
SR2-9	8.7	3.5	0.5	2.0	7.2	
SR2.5-5.8	5.0	5.0	1.4	2.4	2.2~3.2	
SR2.6-3.2	3.2	5.0	1.7	2.6~2.7	1.0~2.0	
SR2.6-4.2	4.2	5.0	1.7	2.6~2.7	2.0~3.0	
SR2.6-4.8	4.8	5.0	1.4	2.6~2.7	2.5~3.4	
SR2.6-5.5	5.5	5.0	1.4	2.6~2.7	3.0~4.3	
SR2.6-6.4	6.4	5.0	1.4	2.6~2.7	4.3~5.0	
SR2.6-7.2	7.2	5.0	1.4	2.6~2.7	5.0~5.8	
SR2.8-24	24.0	6.0	1.7	2.8	18.5~19.5	
SR3-3.5	3.6	6.3	1.7	3.0~3.1	1.0~2.0	
SR3-4.5	4.5	6.3	1.7	3.0~3.1	2.0~3.0	
SR3-5	5.0	6.3	1.7	3.0~3.1	2.5~3.5	
SR3-5.5	5.5	6.3	1.7	3.0~3.1	3.0~3.5	
SR3-5.5-2	5.5	6.3	1.7	3.0	3.0~4.0	
SR3-6	6.0	6.3	1.7	3.0~3.1	3.5~4.5	
SR3-6.5	6.5	6.3	1.7	3.0~3.1	4.0~4.5	
SR3-6.5-1	6.5	6.3	1.7	3.0	4.0~5.0	
SR3-7.5	7.5	6.3	1.7	3.0~3.1	5.0~6.0	
SR3-8	8.1	6.3	1.7	3.0~3.1	5.5~6.5	
SR3-9	9.1	6.3	1.7	3.0~3.1	6.5~7.5	
SR3-10	10.0	6.3	1.7	3.0~3.1	7.5~8.5	
SR3-12	12.0	6.3	1.7	3.0~3.1	7.0~9.0	
SR3-13	13.2	6.3	1.7	3.0~3.1	10.0~11.0	
SR3-15	15.5	6.2	1.7	3.0~3.1	11.5~13.0	
SR3-17	17.0	3.2	1.7	3.0~3.1	12.0~14.0	
SR3-18.5	18.5	6.3	1.7	3.0~3.1	15.0~16.5	
SR3.2-4.5	4.5	6.3	1.7	3.2	1.5~3.0	
SR3.5-3.5	3.5	6.3	1.7	3.5	1.5~2.0	
SR3.5-4.5	4.5	6.3	1.7	3.5	2.0~3.0	
SR3.5-5	5.0	6.3	1.7	3.5	2.5~3.5	
SR3.5-5.5	5.5	6.3	1.7	3.5	3.0~4.0	
SR3.5-6	6.0	6.3	1.7	3.5	3.0~4.0	
SR3.5-7	7.0	6.3	1.7	3.5	4.5~5.5	
SR3.5-7.5	7.5	6.3	1.7	3.5	5.0~6.0	
SR3.5-8	8.0	6.3	1.7	3.5	5.7~6.6	
SR3.5-9	9.0	6.3	1.7	3.5	6.0~7.0	
SR3.5-11D	11.0	4.9	1.7	3.5~3.6	6.5~7.5	
★SR3.5-18.5	18.5	6.3	1.7	3.5	14.5~16.0	
SR3.5-23	23.0	6.3	1.7	3.5	18.5~20.0	
★SR3.5-24	24.0	6.3	1.7	3.5	20.5~21.5	
SR3.5-32	32.0	6.3	1.7	3.5	28.0	
SR3.8-6.5	6.5	6.3	2.0	3.8	4.0~4.5	

尼龍鉚釘 SNAP RIVET

用途：用於PC板、鐵板零件固定，代替螺絲，省時不需工具，結合力強。



- Material: Nylon 66 (UL)
- Flame Class: 94V-2/94V-0
- Color: Natural/Black
- Unit: mm

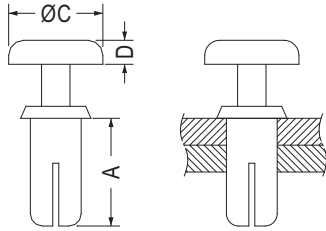

MOUNTING HOLE: ØG
THICKNESS: T

Part No.	A	C	D	G	T	Package	
SR4-4.6	4.6	7.8	1.9	4.0~4.1	2.5~3.5	1000	
SR4-5	5.0	7.8	1.9	4.0	2.5~3.5		
SR4-6	6.1	7.8	1.9	4.0	3.5~4.5		
SR4-7	7.1	8.0	2.0	4.0	4.5~5.5		
SR4-8	8.1	8.0	2.0	4.0	5.5~6.5		
SR4-9	9.0	8.0	2.0	4.0	6.5~7.5		
SR4-10	10.0	8.0	2.0	4.0	7.5~8.5		
SR4-12	12.0	8.0	2.0	4.0	9.5~10.5		
SR4-14	13.7	8.0	2.0	4.0	11.0~12.0		
SR4-15	15.3	8.0	2.0	4.0	11.5~13.0		
SR4-15.5	15.5	8.0	2.0	4.0	11.5~13.0		
SR4-20	20.0	8.0	2.0	4.0	15.0~17.0		500
SR4-25	24.5	8.0	2.0	4.0	22.0~23.0		
SR4.3-5	5.0	7.8	1.9	4.3	2.5~3.5		1000
★SR4.5-21.3	21.3	8.0	1.7	4.5	17.5	500	
SR5-4.5	4.6	8.9	2.2	5.0	1.5~2.5	1000	
SR5-5.5	5.5	8.9	2.0	5.0	2.5~3.5		
SR5-6.5	6.5	8.9	2.2	5.0	3.5~4.5		
SR5-7.5	7.5	8.9	2.2	5.0	4.5~5.5		
SR5-8.5	8.4	8.9	2.2	5.0	5.5~6.5		
SR5-9.5	9.5	8.9	2.1	5.0	5.5~7.5		
SR5-10.5	10.5	8.9	2.1	5.0	6.5~8.5		
SR5-10.5L	10.5	10.0	2.1	5.0	6.5~8.5		
SR5-12	12.0	8.9	2.2	5.0	8.0~9.0		
SR5-14	14.0	8.9	2.2	5.0	10.0~11.0		
SR5-16	16.0	8.9	2.2	5.0	12.0~13.0		
SR5-18	18.0	8.9	2.2	5.0	14.0~15.0		
SR6-6	6.0	12.0	2.5	6.0	2.5~4.0		1000
SR6-8	8.0	12.0	3.0	6.0	4.5~6.0		
SR6-10.5	10.5	12.0	3.0	6.0	7.5~8.5		
SR6-12	12.0	12.0	3.0	6.0	8.0~9.0		
SR6-14	14.0	12.0	3.0	6.0	10.0~11.0		
SR6-16	16.0	12.0	3.0	6.0	12.0~13.0		
SR6-18	18.5	12.0	3.0	6.0	14.0~15.0		
SR6-20	20.0	12.0	3.0	6.0	16.0~17.0		

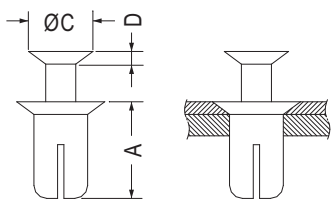

MOUNTING HOLE: ØG
THICKNESS: T

Part No.	A	C	D	G	T	Package
SR3-4.7F	4.7	5.75	0.8	3.0	1.5~2.0	1000
SR3-13F	14.3	5.3	1.3	3.3	10.0~11.0	
SR4-5.5F	5.5	5.8	0.7	4.0	2.0~3.0	
SR4-6F	6.1	7.5	1.1	4.0	3.0~4.0	
SR4-7F	7.2	7.5	1.1	4.0	3.5~5.0	
SR4-7FS	7.0	6.4	0.8	4.0	3.5~5.0	
SR4-8F	8.2	7.5	1.1	4.0	5.5~6.5	
SR4-10F	10.0	6.8	1.5	4.0	7.5~8.5	
SR4-13F	14.5	6.4	1.0	4.0	10.0~11.0	
SR5-4.5F	7.0	8.5	2.5	5.0	3.5~4.5	

尼龍鉚釘 SNAP RIVET

用途：用於風扇之固定。



- Material: Nylon 66 (UL)
- Flame Class: 94V-2/94V-0
- Color: Natural/Black
- Unit: mm

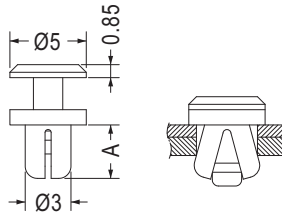

MOUNTING HOLE Ø3.0
THICKNESS: T

Part No.	A	T	Package
SRFA3-3.5	3.5	1.0~2.0	1000
SRFA3-4	4.0	1.5~2.5	

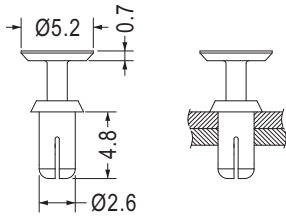

MOUNTING HOLE Ø2.6~Ø2.7
THICKNESS 2.5~3.4

Part No.	Package
SRE2.6-4.8	1000

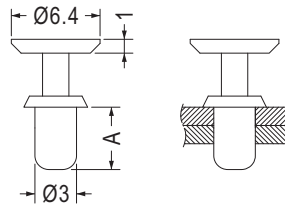

MOUNTING HOLE Ø3.1~Ø3.2
THICKNESS: T

Part No.	A	T	Package
SRE3-4.5	4.5	2.0~3.0	1000
SRE3-5.5	5.5	3.0~4.0	

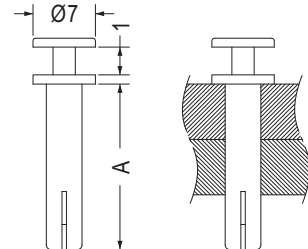

MOUNTING HOLE Ø4.0
THICKNESS: T

Part No.	A	T	Package
SRF4-28	28.0	25.0	500
SRF4-30	30.0	25.0	
SRF4-31	31.0	27.0	

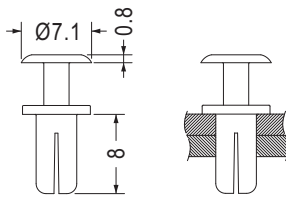

MOUNTING HOLE Ø4.2
THICKNESS 5.5~6.5

Part No.	Package
SRF4-8	1000

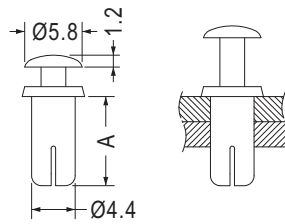

MOUNTING HOLE Ø4.5
THICKNESS: T

Part No.	A	T	Package
SRR4.5-8	8.0	4.2	1000
SRR4.5-9	9.0	5.2	
SRR4.5-10	10.0	6.2	
SRR4.5-12	12.0	8.2	
SRR4.5-14	14.0	10.2	
SRR4.5-16	16.0	12.2	



- Material: Nylon 66 (UL)
- Flame Class: 94V-2/94V-0
- Color: Black
- Unit: mm

用途：用於PC板與機板間固定，省時方便。

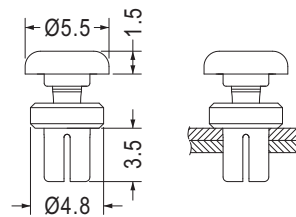

MOUNTING HOLE Ø3.0
THICKNESS 1.6

Part No.	Package
ULCZ-1.6	1000

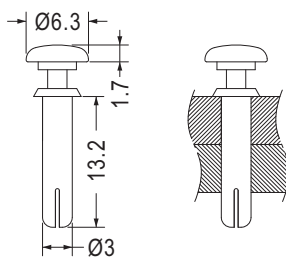

MOUNTING HOLE Ø3.0
THICKNESS 10.0~11.0

Part No.	Package
SRS3-13P	1000

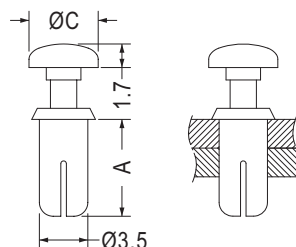

MOUNTING HOLE: ØG
THICKNESS: T

Part No.	A	C	G	T	Package
SRS3.5-4.5P	4.5	6.3	3.5	1.5~3.0	1000
SRS3.5-7P	7.0	5.0	3.5~3.6	4.5~5.5	

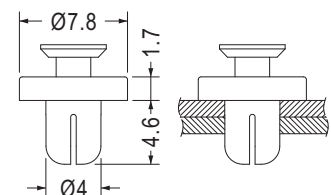

MOUNTING HOLE Ø4.0
THICKNESS 1.8~2.5

Part No.	Package
SRF4-4.6F	1000

尼龍鉚釘 SNAP RIVET

用途：用於PC板與機板間固定，省時方便。



- Material: Nylon 66 (UL)
- Flame Class: 94V-2/94V-0
- Color: Black
- Unit: mm

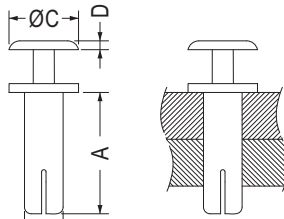

MOUNTING HOLE Ø3.5
THICKNESS: T

Part No.	A	B	C	D	T	Package
SRF3.5-11	11.0	3.5	6.3	0.8	8.0	1000
SRF3.5-29	29.0	3.4	6.3	0.8	25.0	
SRF3.5-37	37.0	3.4	6.3	0.8	34.0	
SRF3.5-61.5	61.5	3.4	5.3	0.5	59.0	500
SRF3.5-62	62.3	3.4	6.3	0.8	58.0	
SRF3.5-65	65.0	3.4	6.3	0.8	62.0	



- Material: Nylon 66 (UL)
- Flame Class: 94V-2/94V-0
- Color: Natural/Black
- Unit: mm

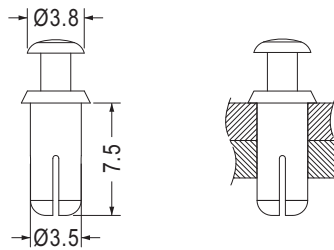

MOUNTING HOLE Ø3.5
THICKNESS 5.0~6.0

Part No.	Package
SRR3.5-7.5	1000

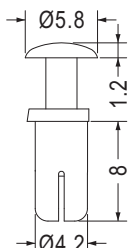

MOUNTING HOLE Ø4.3~Ø4.4
THICKNESS 4.5

Part No.	Package
SRH4.2-8	1000

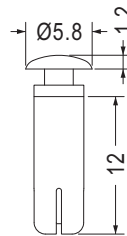

MOUNTING HOLE Ø4.5
THICKNESS 8.2
(RECOMMEND FOR REFERENCE ONLY)

Part No.	Package
★SRRH4.5-12	1000

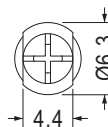
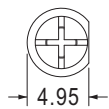

7



- Material: Nylon 66 (UL)
- Flame Class: 94V-2/94V-0
- Color: Natural/Black/Gray
- Unit: mm

用途：用於PC板與機板間固定，省時方便。

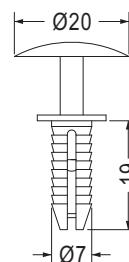

MOUNTING HOLE Ø7.0
THICKNESS 10.0

Part No.	Package
SRB-1	1000

固定扣 DOOR LATCH

用途：固定於兩片鐵板，一般用於機器
的門扣，拆卸方便。



- Clip Material: Nylon 66 (UL) 94V-2/
PC (UL) 94V-2
- Pin Material: Nylon 66 (UL) 94V-2
- DL-11 Material: Pom (UL) 94HB
- Color: Natural/Black
- Unit: mm

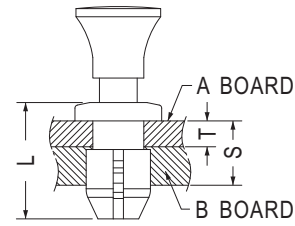

Plunger Head Style					
DL-1/DL-6	DL-2	DL-3/DL-4	DL-5	DL-7	DL-17

Part No.	L	S	T	Hole		Package
				A Board	B Board	
DL-1	11.1	2.0~4.2	1.6	Ø7.5	Ø8.0	500
DL-2	11.1	2.0~4.2	1.6	Ø7.5	Ø8.0	
DL-3	10.4	2.0~4.2	1.6	Ø6.0~Ø6.1	Ø6.4	
DL-4	11.4	3.0~5.2	2.5	Ø6.0~Ø6.1	Ø6.4	
DL-5	9.5	2.0~3.6	1.6	Ø4.5	Ø4.8	
DL-6	12.0	3.5	2.4	Ø6.6	Ø7.8	
DL-7	12.0	3.5	2.4	Ø6.6	Ø7.8	
DL-9	13.0	6.9	4.3	Ø6.0	Ø6.35	
DL-10	11.0	5.5	2.0	Ø6.0	Ø6.4~Ø6.5	
DL-11	10.5	2.1~4.35	1.0~1.65	Ø7.5~Ø7.6	Ø8.0~Ø8.2	
DL-14	11.0	5.5	2.0	Ø6.0	Ø6.4~Ø6.5	
DL-16	10.4	2.0~4.2	1.6	Ø6.0~Ø6.1	Ø6.4	
DL-17	12.67	2.0~3.6	1.6	Ø4.5	Ø4.8	

尼龍鉚釘 SNAP RIVET

用途：用於PC板與機板間固定，省時方
便。



- Material: Nylon 66 (UL)
- Flame Class: 94V-2/94V-0
- Color: Black
- Unit: mm

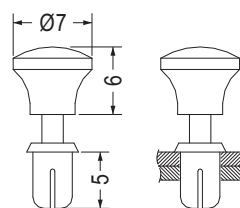

MOUNTING HOLE Ø3.5
THICKNESS 2.5~3.5

Part No.	Package
SRS3.5-5P	1000

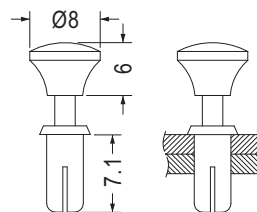

MOUNTING HOLE Ø4.1
THICKNESS 4.5~5.5

Part No.	Package
SRS4-7P	1000

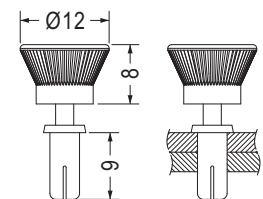

MOUNTING HOLE Ø4.1~Ø4.2
THICKNESS 6.5~7.5

Part No.	Package
SRS4-9K	1000

尼龍鉚釘 SNAP RIVET



- Material: Nylon 66 (UL)
- Pin Material: PC
- Flame Class: 94V-2/94V-0
- Color: Black
- Unit: mm

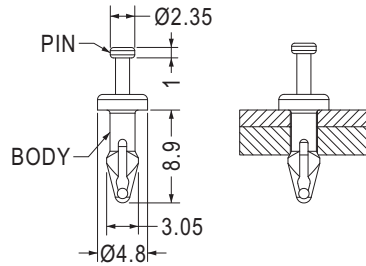

MOUNTING HOLE $\varnothing 2.5 \sim \varnothing 2.6$
THICKNESS 4.0~4.5

Part No.	Package
SRCC-16F	1000

用途：用於風扇之固定。

- Material: Nylon 66 (UL)
- Flame Class: 94V-2/94V-0

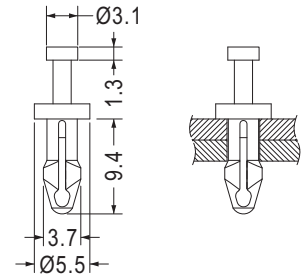

HOLE IN FAN $\varnothing 3.1 \sim \varnothing 3.3$
THICKNESS 3.9~4.6

Part No.	Package
SRCC-12F	1000

鉚釘 SNAP RIVET



- Material: TPE
- Pin Material: Nylon 66 (UL)
- Flame Class: 94V-2/94V-0
- Color: Black
- Unit: mm

HOLE IN FAN $\varnothing 3.6$
THICKNESS 0.8

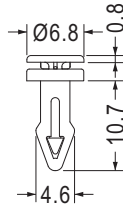

HOLE IN FAN $\varnothing 3.5$
THICKNESS 5.0

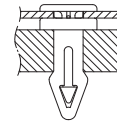

Part No.	Package
SRCC-13	1000

- Material: TPV (UL)
- Pin Material: Nylon 66 (UL)
- Flame Class: 94V-0

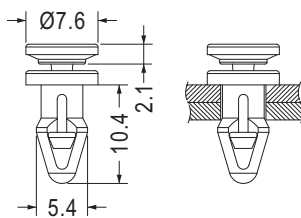

HOLE IN FAN $\varnothing 4.5$
THICKNESS 3.5

Part No.	Package
SRCC-11	1000

- Material: TPU
- Pin Material: Nylon 66 (UL)
- Flame Class: 94V-2

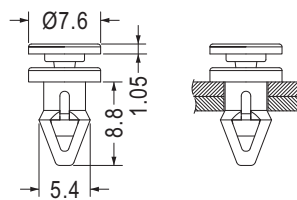

HOLE IN FAN $\varnothing 4.4$
THICKNESS 3.0

Part No.	Package
SRCC-9	1000

- Material: TPE(UL)
- Pin Material: Nylon 66 (UL)
- Flame Class: 94V-0

HOLE IN FAN $\varnothing 4.5$
THICKNESS 1.0~1.2

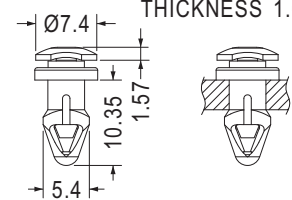

HOLE IN FAN $\varnothing 4.45$
THICKNESS 4.0

Part No.	Package
★SRCC-18	1000

尼龍鉚釘 SNAP RIVET



- Material: Nylon 66 (UL)
- Flame Class: 94V-2/94V-0
- Color: Natural/Black
- Unit: mm

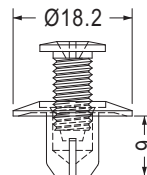

MOUNTING HOLE $\varnothing 8.0$
THICKNESS 3.5~4.2

Part No.	Package
PR-1	500

用途：用於PC板、鐵板零件固定，結合力量。

尼龍鉚釘 SNAP RIVET

用途：用於CPU座或散熱風扇與主機板之固定。



- Material: Nylon 66 (UL)
- Flame Class: 94V-2/94V-0
- Color: Natural/Black
- Unit: mm

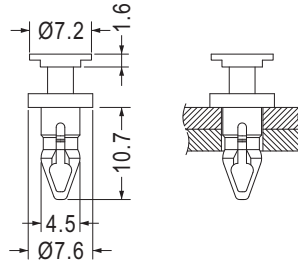

MOUNTING HOLE Ø4.6
THICKNESS 4.8

Part No.	Package
SRCC-4F	1000

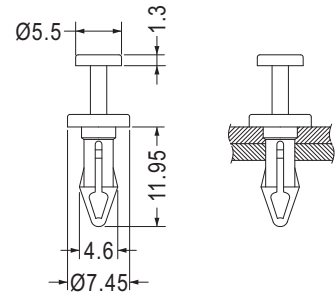

MOUNTING HOLE Ø4.1
THICKNESS 4.8

Part No.	Package
SRCC-5	1000

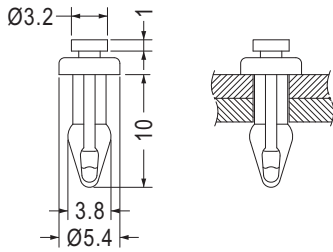

MOUNTING HOLE Ø3.0
THICKNESS 4.4

Part No.	Package
SRCC-7	1000

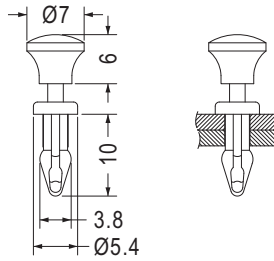

MOUNTING HOLE Ø3.0
THICKNESS 4.4

Part No.	Package
SRCC-7-1F	1000

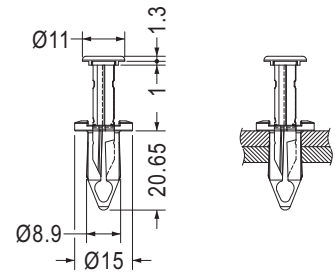

MOUNTING HOLE Ø8.0~Ø8.3
THICKNESS 3.0~8.0

Part No.	Package
SRCC-14	500



- Material: Nylon 66 (UL)
- Flame Class: 94V-2/94V-0
- Color: Natural/Black
- Unit: mm

用途：用於PC板與機板間固定，省時方便。

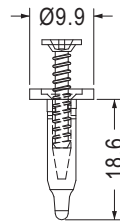

MOUNTING HOLE Ø4.5~Ø4.7
THICKNESS 8.3~10.0

Part No.	Package
PR-2	1000

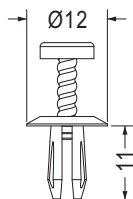

MOUNTING HOLE Ø5.0
THICKNESS 2.5~6.0

Part No.	Package
PR-5	1000

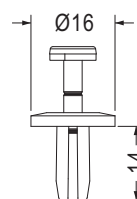

MOUNTING HOLE Ø7.0
THICKNESS 6.0

Part No.	Package
PR-6	1000

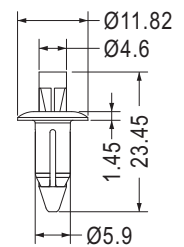

MOUNTING HOLE Ø6.3
THICKNESS 7.0

Part No.	Package
PR-7	1000

- Material: POM

尼龍鉚釘 SNAP RIVET

用途：用於PC板與機板間固定，省時方便。



- Material: PC (UL)
- Flame Class: 94V-0
- Color: White/Black
- Unit: mm

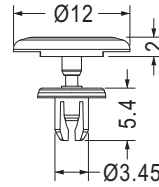

MOUNTING HOLE Ø3.5
THICKNESS 1.6~2.4

Part No.	Package
SRU3.5-4.5	1000

鉚釘 SNAP RIVET

用途：用於PC板、鐵板零件固定，結合力強。



- Material: POM
- Color: Black
- Unit: mm

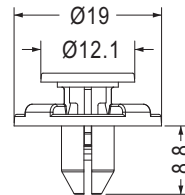

MOUNTING HOLE Ø7.0
THICKNESS 3.2~3.8

Part No.	Package
DLB-1	1000



- Material: PC (UL)
- Flame Class: 94V-0
- Color: Natural
- Patented (專利品)

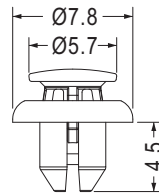

RECOMMEND MOUNTING HOLE Ø4.4~Ø4.5
RECOMMEND THICKNESS 1.0~1.2

Part No.	Package
DLB-2	1000

尼龍鉚釘 SNAP RIVET

用途：用於車用板件或板件間之固定，使用方便。



- Material: Nylon 66 (UL)
- Flame Class: 94V-2/94V-0
- Color: Natural/Black
- Unit: mm

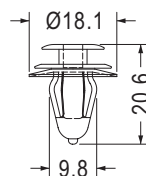

MOUNTING HOLE Ø8.0
THICKNESS 0.8~1.6

Part No.	Package
CAPR-10	500

尼龍鉚釘 SNAP RIVET

用途：用於裝配的孔或機板間之固定，
敲入後可牢固於物件上。



- Material: Nylon 66 (UL)
- Flame Class: 94V-2/94V-0
- Color: Natural/Black
- Unit: mm

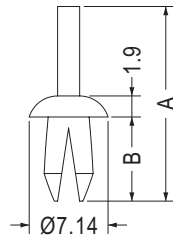

MOUNTING HOLE: ØG
THICKNESS: T

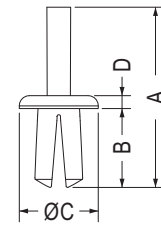

MOUNTING HOLE: ØG
THICKNESS: T

- Material: Nylon 66 (UL)/PP
- Flame Class: 94V-2/94V-0
- Color: Natural/Black/Gray

Part No.	A	B	G	T	Package
PSR-1	17.62	7.62	4.0	1.57~5.0	1000
PSR-2	16.1	7.4	4.8	1.57~5.53	

Part No.	A	B	C	D	G	T	Package
PSR-3	26.5	11.6	11.6	1.9	6.3	5.0	1000
PSR-4	17.8	7.9	8.7	2.0	4.8	4.0	

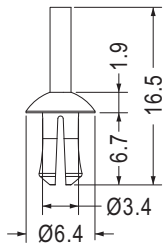

MOUNTING HOLE Ø3.4~Ø3.7
THICKNESS 3.4~4.8

Part No.	Package
PSR-6	1000

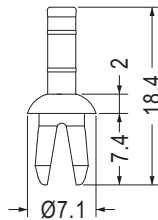

MOUNTING HOLE Ø5.0
THICKNESS 1.5~5.0

Part No.	Package
PSR-5	1000

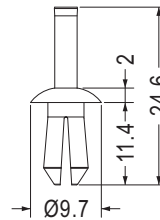

MOUNTING HOLE Ø5.0
THICKNESS 3.0~7.0

Part No.	Package
PSR-7	1000

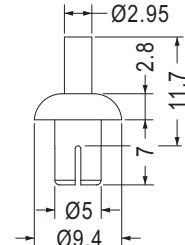

MOUNTING HOLE Ø5.1
THICKNESS 4.1~5.1

Part No.	Package
PSR5.1-7	1000

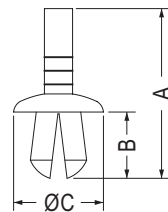

MOUNTING HOLE: ØG
THICKNESS: T

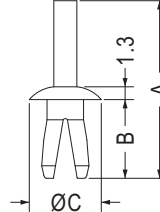

MOUNTING HOLE: ØG
THICKNESS: T

【 PSR-8 】

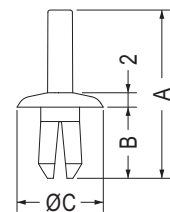

MOUNTING HOLE: ØG
THICKNESS: T

【 PSR5.5-10S 】

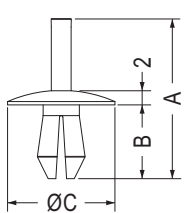

MOUNTING HOLE: ØG
THICKNESS: T

【 PSR5.5-11 】

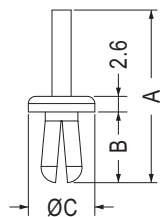

MOUNTING HOLE: ØG
THICKNESS: T

【 PSR5.5-11.5 】

Part No.	A	B	C	D	G	T	Package
PSR-8	18.0	8.2	7.5	1.3	4.0~4.2	4.0~6.5	1000
PSR5-7	18.7	7.3	9.9	2.0	5.2	2.0	
PSR5.5-10S	23.4	9.9	12.0	2.0	5.5	7.0	
PSR5.5-10	26.7	10.0	14.6	3.8	5.7~6.0	7.0	
PSR5.5-11	23.8	11.0	16.0	2.0	5.5~6.4	2.5~6.5	
PSR5.5-11.5	28.8	11.8	11.1	2.6	5.5	2.4~7.9	
PSR5.5-15	36.5	14.9	14.6	3.8	6.0	10.0	

尼龍鉚釘 SNAP RIVET

用途：用於裝配的孔或機板間之固定，敲入後可牢固於物件上。



- Material: Nylon 6 (UL)
- Flame Class: 94V-2
- Color: Natural/Black
- Unit: mm

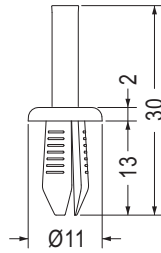

MOUNTING HOLE $\varnothing 6.0 \sim \varnothing 6.4$
THICKNESS 6.0

Part No.	Package
PSR6-1	1000

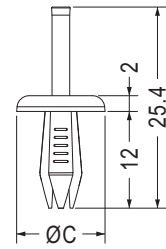

MOUNTING HOLE $\varnothing 4.0$
THICKNESS 5.0

- Color: Blue

Part No.	C	Package
PSR4-12	9.0	1000
PSR4-12L	11.0	

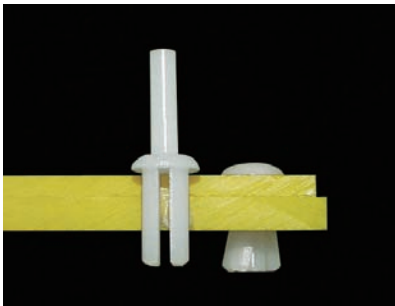

- Material: Nylon 66 (UL)
- Flame Class: 94V-2/94V-0
- Color: Natural/White/Black
- Unit: mm

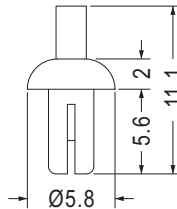

MOUNTING HOLE $\varnothing 3.0$
THICKNESS 3.0

Part No.	Package
PSR3-5.5	1000

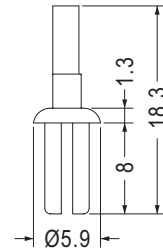

MOUNTING HOLE $\varnothing 4.0$
THICKNESS 4.0

Part No.	Package
PSR4-8	1000

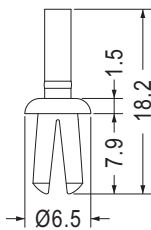

MOUNTING HOLE $\varnothing 4.0$
THICKNESS 1.5~6.0

Part No.	Package
PSR4-7.5	1000

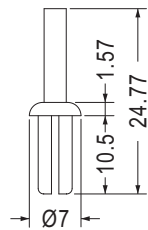

MOUNTING HOLE $\varnothing 4.6 \sim \varnothing 4.8$
THICKNESS 6.5

Part No.	Package
PSR48-10	1000

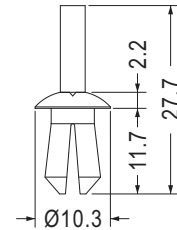

MOUNTING HOLE $\varnothing 6.0$
THICKNESS 6.0

Part No.	Package
PSR6-11	1000

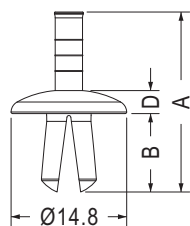

MOUNTING HOLE: $\varnothing G$
THICKNESS: T

Part No.	A	B	D	G	T	Package
PSR6-10	23.0	10.0	2.95	6.0	2.0~7.0	1000
PSR6-15	36.8	15.0	3.8	6.35	6.0	

- Material: PE
- Color: Gray

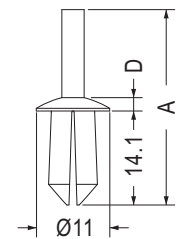

MOUNTING HOLE $\varnothing 7.0$
THICKNESS 7.0

Part No.	A	D	Package
PSR6-14	29.3	2.0	1000
PSR6-14L	30.3	3.0	

尼龍鉚釘 SNAP RIVET

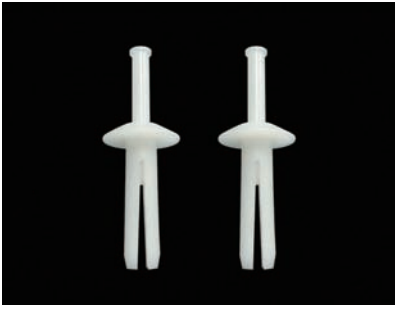

- Material: Nylon 66 (UL)
- Flame Class: 94V-2/94V-0
- Color: Natural/Black
- Unit: mm

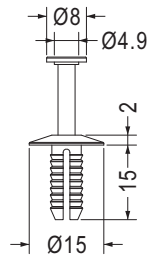

MOUNTING HOLE Ø6.35

Part No.	Package
PSRB-1	1000

用途：用於裝配的孔或機板間之固定，敲入後可牢固於物件上。

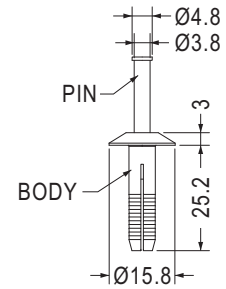

MOUNTING HOLE Ø6.4

Part No.	Package
PSR64-25	1000

尼龍鉚釘 MOUNTING BUTTON

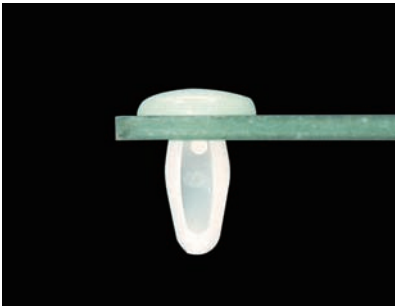

- Material: POM (UL)/Nylon 66 (UL)
- Flame Class: 94HB/94V-2/94V-0
- Color: Natural/Black
- Unit: mm

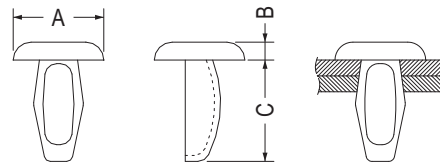

MOUNTING HOLE: G
BOARD THICKNESS: T

用途：用於PC板與機板間固定，省時方便。

Part No.	A	B	C	G	T	Package
MB-1	7.6	1.6	8.6	3.3~3.5	2.0~3.1	2000
MB-2	7.6	1.3	10.8	3.3~3.6	3.0~4.0	1000
MB-3	7.3	1.4	8.4	3.0~3.2	2.0~3.5	2000



- Material: Nylon 66 (UL)
- Flame Class: 94V-2/94V-0
- Color: Natural/Black
- Unit: mm

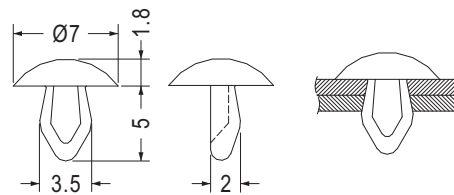

MOUNTING HOLE Ø3.15~Ø3.2
THICKNESS 1.6~1.9

Part No.	Package
MB-4	2000

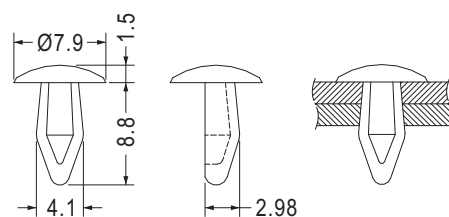

MOUNTING HOLE Ø3.5~Ø3.7
THICKNESS 3.5~4.0

Part No.	Package
MB-5	2000

尼龍鉚釘 MOUNTING BUTTON

用途：用於PC板與機板間固定，省時方便。



- Material: Nylon 66 (UL)
- Flame Class: 94V-2/94V-0
- Color: Natural/Black
- Unit: mm

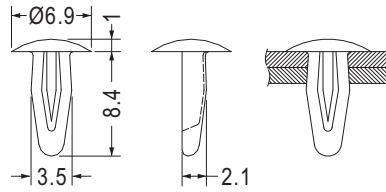

MOUNTING HOLE Ø3.1~Ø3.2
THICKNESS 2.0~2.5

Part No.	Package
MB-6	2000

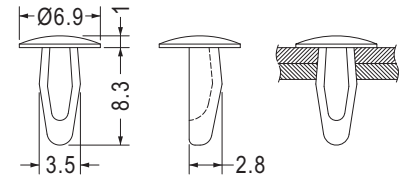

MOUNTING HOLE Ø3.1~Ø3.2
THICKNESS 2.0~2.5

Part No.	Package
MB-7	2000

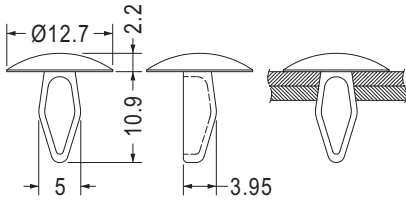

MOUNTING HOLE Ø4.0
THICKNESS 2.5~3.5

Part No.	Package
MB-18	1000

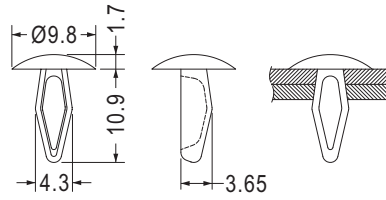

MOUNTING HOLE Ø3.9~Ø4.05
THICKNESS 2.1~3.7

Part No.	Package
MB-19	1000

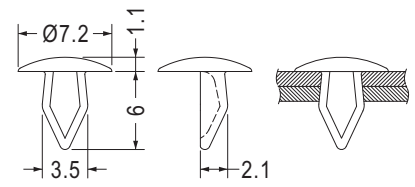

MOUNTING HOLE Ø3.0~Ø3.2
THICKNESS 0.8~2.0

Part No.	Package
MB-27	1000

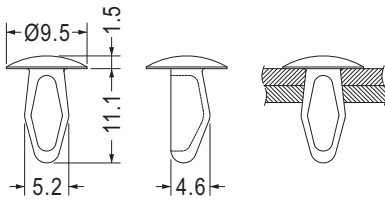

MOUNTING HOLE Ø4.7~Ø4.8
THICKNESS 2.5~4.0

Part No.	Package
MB-36	2000

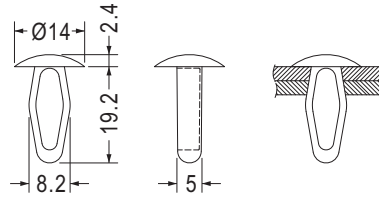

MOUNTING HOLE Ø6.4
THICKNESS 5.0

Part No.	Package
MB-39	1000

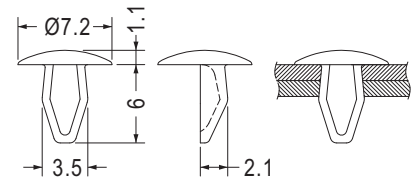

MOUNTING HOLE Ø3.0~Ø3.2
THICKNESS 0.8~2.0

Part No.	Package
MB-43	2000

- Material: PC+ABS (UL)
- Flame Class: 94V-0

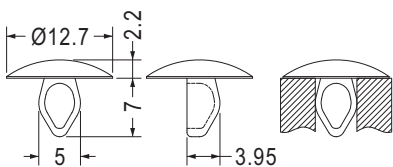

MOUNTING HOLE Ø4.8
THICKNESS 2.5

Part No.	Package
MB-52	2000

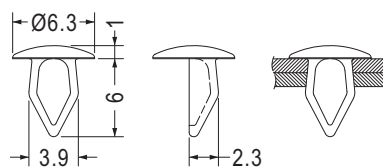

MOUNTING HOLE Ø3.5
THICKNESS 0.8~2.0

Part No.	Package
MB-55	2000

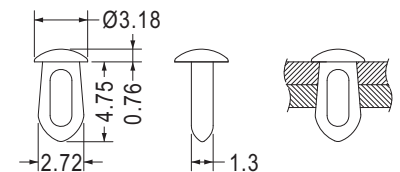

MOUNTING HOLE Ø2.16~Ø2.29
THICKNESS 0.81~2.72

Part No.	Package
MB-56	1000

尼龍鉚釘 MOUNTING BUTTON

用途：用於PC板與機板間固定，省時方便。

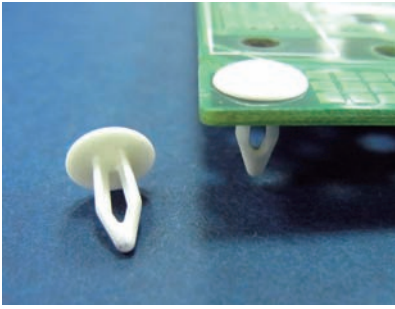

- Material: Nylon 66 (UL)
- Flame Class: 94V-2/94V-0
- Color: Natural/Black
- Unit: mm

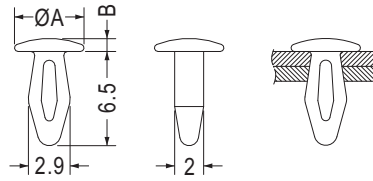

MOUNTING HOLE Ø2.5
THICKNESS 2.0~2.5

Part No.	A	B	Package
MB-16	4.8	0.9	1000
MB-21	4.75	0.95	

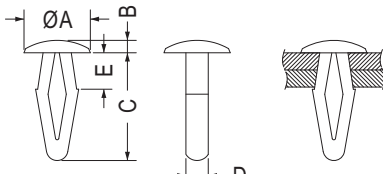

MOUNTING HOLE: ØG
THICKNESS: T

- Material: Nylon 66 (UL)/POM (UL)
- Flame Class: 94HB/94V-2/94V-0

Part No.	A	B	C	D	E	G	T	Package
MB-23	9.0	1.6	14.0	2.9	5.0	3.9	1.0~5.0	1000
MB-23L	9.0	1.6	14.0	2.9	6.1	3.9	1.0~6.0	
MB-28	8.0	1.5	13.0	2.7	4.4	3.2	1.0~4.5	2000
MB-58	7.6	1.4	11.5	2.6	6.5	3.2	3.5~6.3	

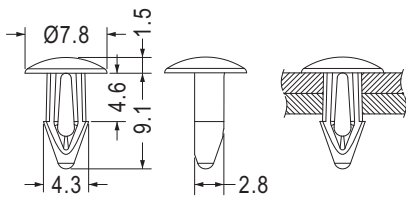

MOUNTING HOLE Ø3.6

- Material: Nylon 66 (UL)/PBT (UL)
- Flame Class: 94V-2/94V-0

Part No.	Package
MB-34	2000

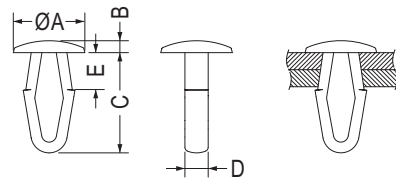

MOUNTING HOLE: ØG
THICKNESS: T

- Material: Nylon 66 (UL)/POM (UL)
- Flame Class: 94HB/94V-2/94V-0

Part No.	A	B	C	D	E	G	T	Package
MB-30	12.0	2.0	16.8	3.9	6.2	6.4	1.5~6.2	2000
MB-48	11.0	2.9	15.0	3.4	5.7	4.7	1.0~5.5	

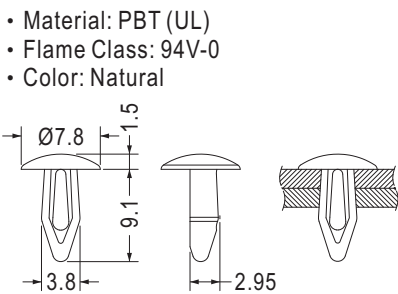

MOUNTING HOLE Ø3.5
THICKNESS 3.5~4.3

Part No.	Package
MB-44	2000

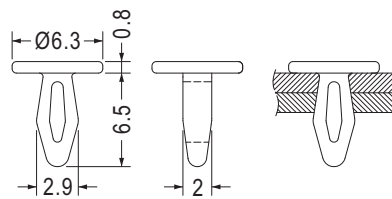

MOUNTING HOLE Ø2.5
THICKNESS 2.0~2.5

Part No.	Package
MB-50	2000

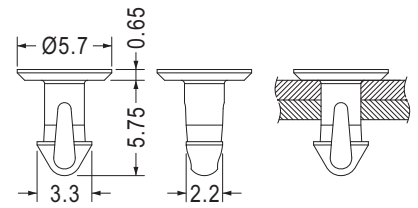

MOUNTING HOLE Ø2.5
THICKNESS 3.5

Part No.	Package
MB-60	2000

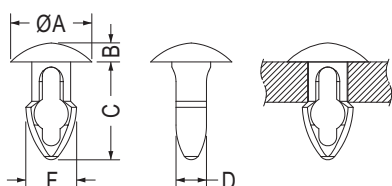

MOUNTING HOLE: ØG
THICKNESS: T

Part No.	A	B	C	D	F	G	T	Package
MB-57	6.4	1.5	7.7	2.4	4.0	3.17	3.17	2000
MB-59	7.93	1.57	9.53	2.6	5.1	4.0	4.0	
MB-61	6.35	1.57	6.95	2.45	4.2	3.17	2.36	
MB-62	6.35	1.57	8.6	2.5	4.2	3.17	4.0	
MB-64	8.0	1.57	10.43	4.4	6.05	4.75	3.18	
MB-65	8.0	1.57	11.63	4.4	6.05	4.75	4.75	
MB-66	8.0	1.57	13.43	4.4	6.05	4.75	6.35	

尼龍鉚釘 MOUNTING BUTTON

用途：用於各種零件間之固定，省時方便。



- Material: Nylon 66 (UL)/POM (UL)
- Flame Class: 94HB/94V-2/94V-0
- Color: White/Black
- Unit: mm

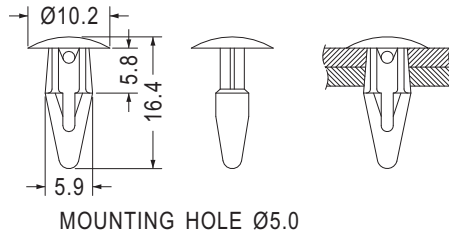

Part No.	Package
MBT-1	1000



- Material: Nylon 66 (UL)
- Flame Class: 94V-2/94V-0
- Color: Natural/Black
- Unit: mm

用途：用於PC板與機板間固定，省時方便。

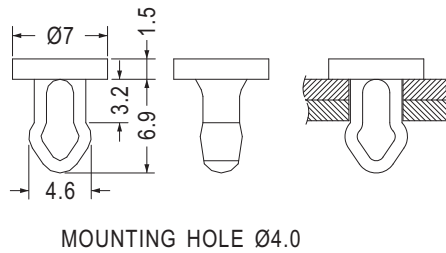

Part No.	Package
MBT-2	2000

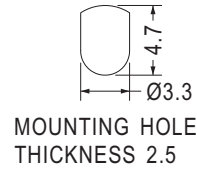
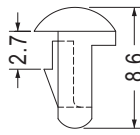
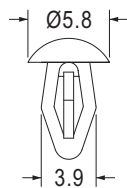

Part No.	Package
MBS3-3	2000

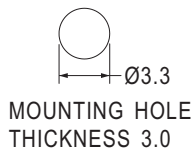
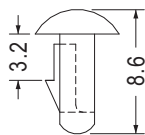
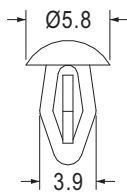

Part No.	Package
MBS3-3	2000

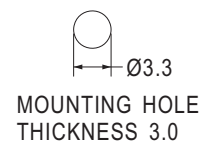
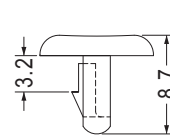
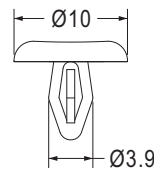

Part No.	Package
MBS3-4	1000



- Material: Nylon 66 (UL)
- Flame Class: 94V-2/94V-0
- Color: Natural/Black
- Unit: mm

用途：裝於機殼上，避免使用者不當自行拆機。

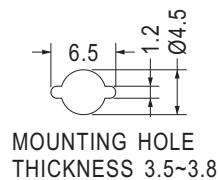
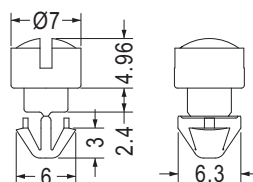

Part No.	Package
LEFS-2	1000

尼龍鉚釘 MOUNTING BUTTON

用途：用於PC板與機板間固定，省時方便。



- Material: Nylon 66 (UL)
- Flame Class: 94V-2/94V-0
- Color: Natural/Black
- Unit: mm

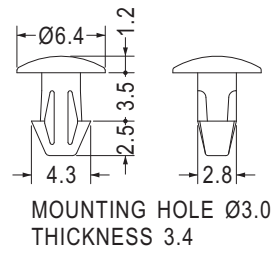

Part No.	Package
HSR-8A	1000

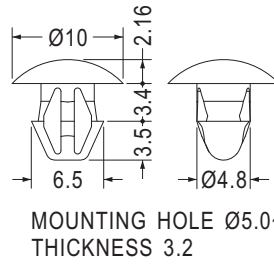
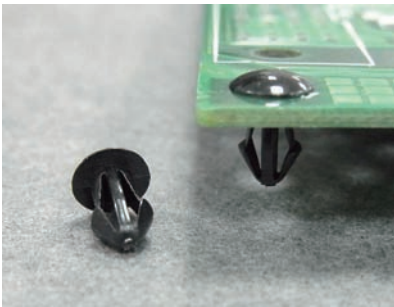

Part No.	Package
HSRA-1	1000

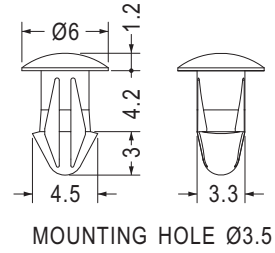

Part No.	Package
MB-33	1000

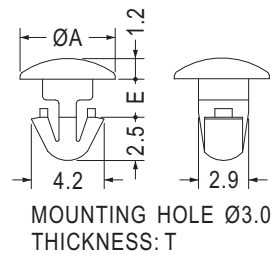
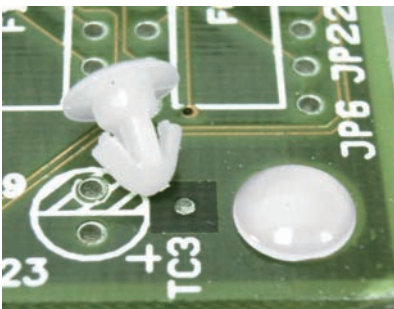

Part No.	A	E	T	Package
MBL3-2	5.5	2.2	2.0	2000
MBL3-2.5	6.4	2.5	2.4	
MBL3-3	6.4	3.0	2.8	
MBL3-3.5	5.5	3.7	3.5	

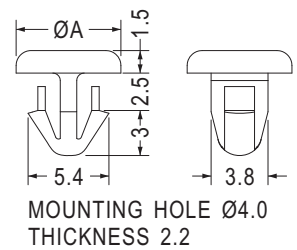

Part No.	A	Package
MB-32	7.0	1000
MB-53	8.0	



- Material: Nylon 66 (UL)
- Flame Class: 94V-2/94V-0
- Color: Natural/Black
- Unit: mm

用途：裝於機殼上，避免使用者不當自行拆機。

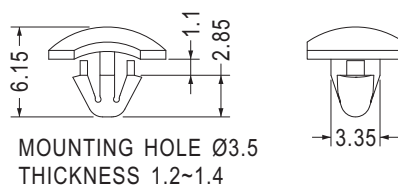
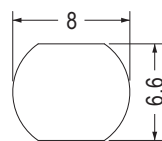

Part No.	Package
MB-45	1000

尼龍鉚釘 MOUNTING BUTTON

用途：用於PC板與機板間固定，省時方便。



- Material: Nylon 66 (UL)
- Flame Class: 94V-2/94V-0
- Color: Natural/Black
- Unit: mm

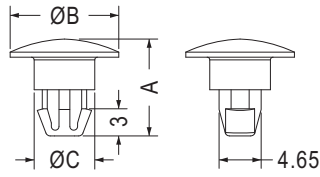

MOUNTING HOLE Ø4.8
THICKNESS: T

Part No.	A	B	C	T	Package
MBL4.8-2	10.7	12.0	6.7	2.0	1000
MBL4.8-2-4	11.1	12.0	6.7	2.0	
MBL4.8-2.4	11.2	12.0	6.7	2.4	
MBL4.8-3	11.1	10.0	7.3	2.0	
MBL4.8-4	12.8	12.0	6.7	4.0	

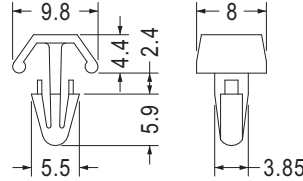
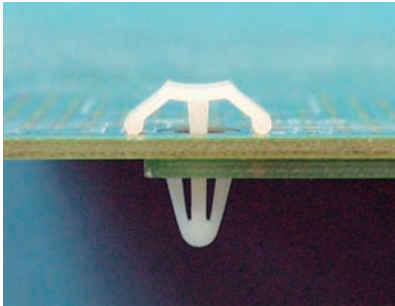

MOUNTING HOLE Ø4.0
THICKNESS 2.5~3.2

Part No.	Package
MB-10	1000

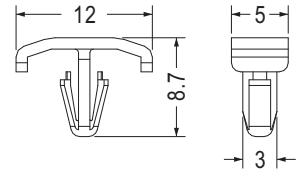

MOUNTING HOLE Ø3.2
THICKNESS 0.8~2.3

Part No.	Package
MB-12	1000

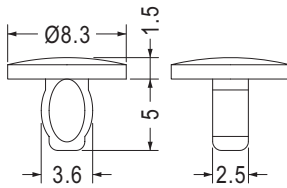

MOUNTING HOLE Ø3.0~Ø3.2
THICKNESS 1.8

Part No.	Package
MB-8	1000

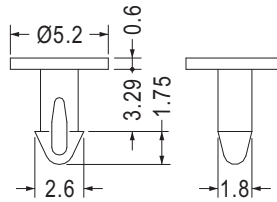

MOUNTING HOLE Ø2.0
THICKNESS 3.2

Part No.	Package
MB-14	2000

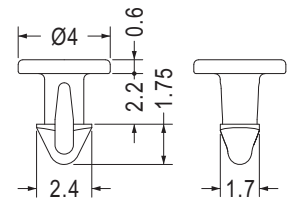

MOUNTING HOLE Ø2.0
THICKNESS 1.9

Part No.	Package
MB-63	2000

7

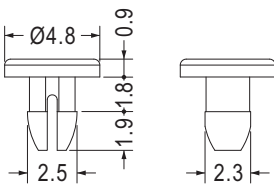

MOUNTING HOLE Ø2.3
THICKNESS 1.6

Part No.	Package
MBT2.3-1.6	2000

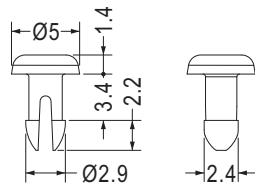

MOUNTING HOLE Ø2.5
THICKNESS 3.2

Part No.	Package
MBT2.5-3.2	2000

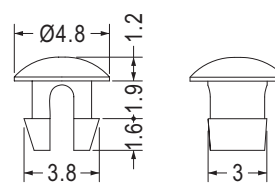

MOUNTING HOLE Ø3.0
THICKNESS 1.6~1.8

Part No.	Package
MBT3-2	2000

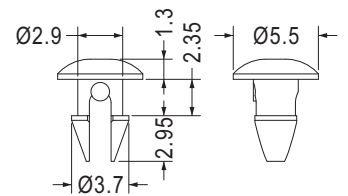

MOUNTING HOLE Ø3.0
THICKNESS 2.2

Part No.	Package
MBT-17	2000

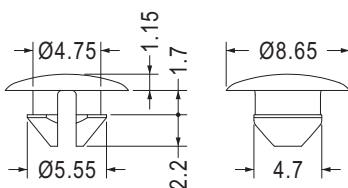

MOUNTING HOLE Ø4.8
THICKNESS 1.6

Part No.	Package
MBT-15	2000

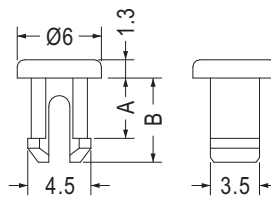

MOUNTING HOLE Ø4.0

Part No.	A	B	Package
MBT-7	4.3	6.0	2000
MBT4-2	2.0	3.7	

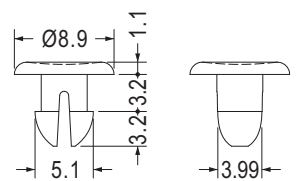

MOUNTING HOLE Ø4.5
THICKNESS 3.0

Part No.	Package
MBT-10	1000

鉚釘 MOUNTING BUTTON

用途：用於螺絲孔的塞頭。



- Material: PC+ABS (UL)
- Flame Class: 94V-2/94V-0
- Color: Black/Gray
- Unit: mm

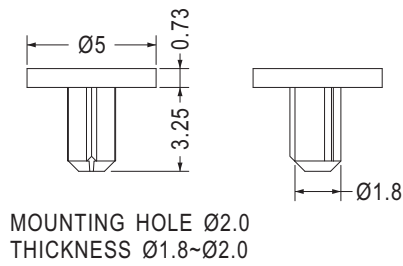

Part No.	Package
MB-20	2000



- Material: PC
- Color: Black
- Unit: mm

用途：用於PC板與機板間固定，省時方便。

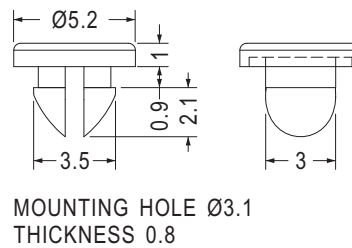

Part No.	Package
MBT3.1-0.8	2000

尼龍鉚釘 MOUNTING BUTTON

用途：用於PC板與機板間固定，省時方便。



- Material: Nylon 66 (UL)
- Flame Class: 94V-2/94V-0
- Color: Natural/Black
- Unit: mm

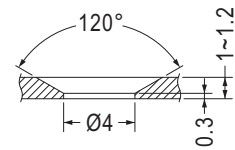
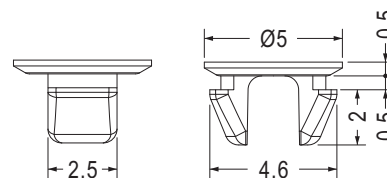

MOUNTING HOLE Ø4.0
CHASSIS THICKNESS 1.0~1.2

Part No.	Package
MBE4-1.2	1000

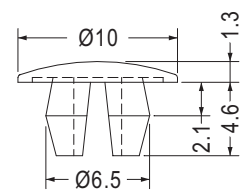
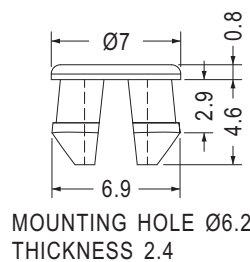

Part No.	Package
MBT6.2-3	2000

Part No.	Package
MBT6-2	2000



MOUNTING HOLE Ø6.35
THICKNESS 0.79~1.58

Part No.	Package
MBT-11	2000

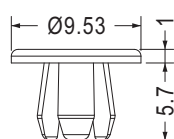

MOUNTING HOLE Ø4.8
THICKNESS 0.8~3.6

Part No.	Package
MBT-12	2000

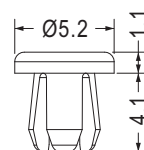

MOUNTING HOLE Ø3.2
THICKNESS 0.8~2.4

Part No.	Package
MBT-16	2000

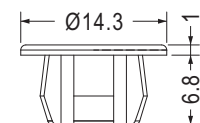

MOUNTING HOLE Ø9.5
THICKNESS 0.8~3.6

Part No.	Package
MBT-13	1000

尼龍鉚釘 SNAP RIVET

用途：用於PC板、鐵板、書本間固定，
結合力強，搭配BRR1-1使用。

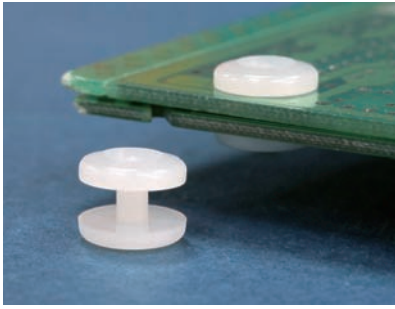

- Material: Nylon 66 (UL)
- Flame Class: 94V-2/94V-0
- Color: Natural/Black
- Unit: mm

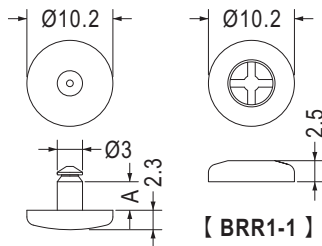

Part No.	A	T	Package
BRP1-1.6	1.6	0.76	1000
BRP1-2.4	2.4	1.57	
BRP1-3.4	3.3	2.54	
BRP1-4	4.0	3.18	
BRP1-5.6	5.5	4.75	
BRP1-7.2	7.1	6.35	



- Material: Nylon 66 (UL)
- Flame Class: 94V-2/94V-0
- Color: Natural/Black
- Unit: mm

用途：用於PC板與機板間固定，省時方便。

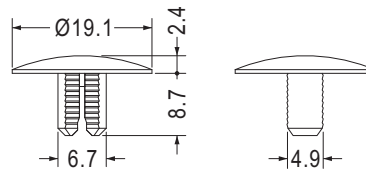

Part No.	Package
MBG2-8.7	1000

尼龍鉚釘 MOUNTING BUTTON

用途：用於木板、鐵板、PC板...等，板子間的結合固定。



- Material: Nylon 66 (UL)
- Flame Class: 94V-2/94V-0
- Color: Natural/Black
- Unit: mm

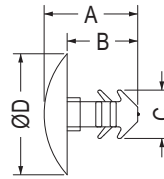

Part No.	A	B	C	D	G	T	Package
MBW-47	6.5	4.9	3.4	8.4	3.0	1.6~3.0	1000
MBW-60	6.9	5.3	3.7	8.7	3.2	1.6~3.2	2000

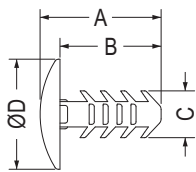

Part No.	A	B	C	D	G	T	Package
MBW-31	9.6	8.0	3.7	8.7	3.2	1.57~6.35	1000
MBW-32	12.5	10.0	7.0	17.8	6.35	1.57~6.35	
MBW-59	12.0	9.5	5.8	15.9	5.25	1.57~6.35	
MBW-62	9.2	7.6	3.4	8.4	3.0	1.6~6.0	
MBW-63	10.8	8.8	5.2	12.7	4.8	1.6~6.4	
MBW-65	13.8	11.3	10.3	25.4	9.5	1.6~6.4	
MBW-66	10.3	8.3	4.6	11.2	4.0	1.6~6.0	
MBW-68	11.3	9.3	6.4	16.8	6.0	1.6~6.0	

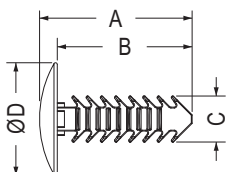

Part No.	A	B	C	D	G	T	Package
MBW-33	22.4	19.9	8.5	12.5	7.9	1.6~15.9	1000
MBW-43	22.4	19.7	5.8	22.4	7.9	1.6~15.9	
MBW-49	13.2	11.6	3.7	8.7	3.2	1.6~9.5	
MBW-50	17.2	15.2	5.2	12.7	4.8	1.6~12.7	
MBW-56	21.0	19.0	5.25	8.0	4.8	2.1~15.9	
MBW-58	20.0	17.5	10.2	25.4	9.5	1.6~12.7	2000
MBW-64	13.3	11.7	3.45	8.4	3.0	1.6~10.0	
MBW-67	14.3	12.3	5.3	14.0	5.0	1.6~10.0	1000
MBW-69	15.9	13.4	8.5	22.2	7.9	1.6~9.5	
MBW-70	15.6	13.1	7.8	20.0	7.1	1.6~9.5	
MBW-75	28.4	25.9	7.8	20.0	7.15	1.6~22.3	
★MBW-77	16.5	14.5	10.5	15.0	10.0	1.6~9.5	

尼龍鉚釘 MOUNTING BUTTON

用途：用於木板、鐵板、PC板...等，板子間的結合固定。



- Material: Nylon 6 (UL)/Nylon 66 (UL)
- Flame Class: 94V-2/94V-0
- Color: Natural/Black
- Unit: mm

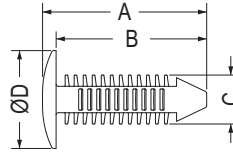

MOUNTING HOLE: ØG
THICKNESS: T

Part No.	A	B	C	D	G	T	Package
MBW-17	18.5	17.5	5.6	11.7	4.8	2.54~15.2	1000
MBW-23	21.5	20.5	5.6	11.7	4.8	4.0~25.0	
MBW-42S	12.3	11.0	3.3	6.0	2.7~3.3	1.5~8.0	
MBW-42	12.3	11.0	3.4	6.0	3.0~3.3	1.5~8.0	
MBW-73	19.2	18.0	3.3	6.0	2.7~3.3	1.5~15.0	
MBW-74	21.8	20.0	6.5	13.0	5.6~6.4	1.5~15.0	



- Material: Nylon 66 (UL)
- Flame Class: 94V-2/94V-0
- Color: Natural/Black
- Unit: mm

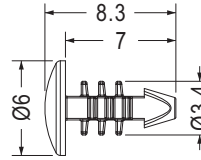

MOUNTING HOLE Ø2.7~3.3
THICKNESS 1.5~4.0



Part No.	Package
MBW-7S	2000

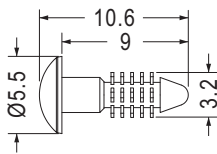

MOUNTING HOLE Ø3.0

Part No.	Package
MBW-9	1000

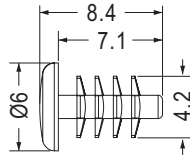

MOUNTING HOLE Ø3.5

Part No.	Package
MBW-7	1000

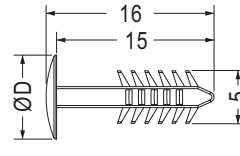

MOUNTING HOLE Ø4.0
THICKNESS 5.7~10.7

Part No.	D	Package
MBW-28	8.0	1000
MBW-28L	10.0	

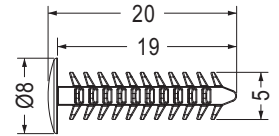

MOUNTING HOLE Ø4.0
THICKNESS 2.1~15.9

Part No.	Package
MBW-55	1000

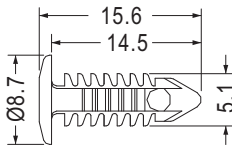

MOUNTING HOLE Ø4.5~Ø4.8

Part No.	Package
MBW-14	1000

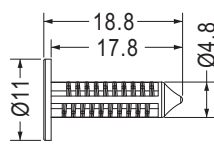

MOUNTING HOLE Ø5.0
THICKNESS 1.5~11.0

Part No.	Package
MBW-52	1000

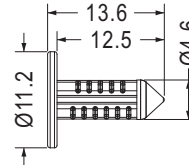

MOUNTING HOLE Ø5.0
THICKNESS 2.5~4.5

Part No.	Package
MBW-29	1000

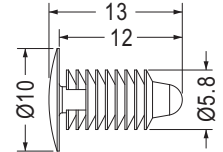

MOUNTING HOLE Ø5.5
THICKNESS 0.7~6.4

Part No.	Package
MBW5-12	1000

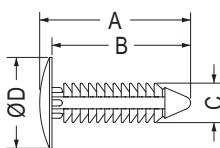

MOUNTING HOLE: ØG
THICKNESS: T

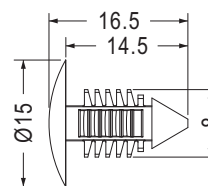

MOUNTING HOLE Ø7.0
THICKNESS 3.2~6.0

Part No.	Package
MBW-27	1000

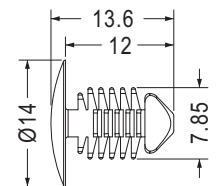

MOUNTING HOLE Ø7.0~Ø7.1
THICKNESS 3.0~7.0

Part No.	Package
MBW-71	1000

Part No.	A	B	C	D	G	T	Package
MBW-24	29.4	27.0	7.7	17.7	6.4~7.0	2.5~30.0	1000
MBW-51	22.9	20.4	7.7	17.8	6.0~6.3	2.5~12.0	
MBW-61	32.5	30.0	8.3	19.0	7.1	1.5~25.4	

尼龍鉚釘 MOUNTING BUTTON

用途：用於木板、鐵板、PC板...等，板子間的結合固定。



- Material: Nylon 66 (UL)
- Flame Class: 94V-2/94V-0
- Color: Natural/Black
- Unit: mm

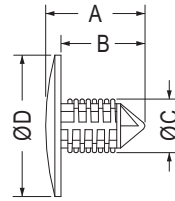

MOUNTING HOLE: $\varnothing G$
THICKNESS: T

Part No.	A	B	C	D	G	T	Package
MBW6-11	13.0	11.0	7.4	18.5	6.35	0.8~7.4	1000
MBW7-20	23.0	20.0	7.86	25.4	7.0	2.54~20.0	

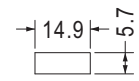
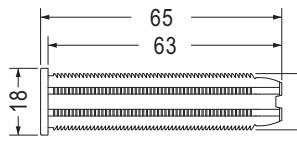

MOUNTING HOLE THICKNESS 60.0

Part No.	Package
MBW-34	500

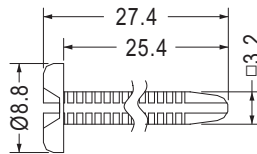

MOUNTING HOLE $\varnothing 3.0$

Part No.	Package
MBW-18	1000

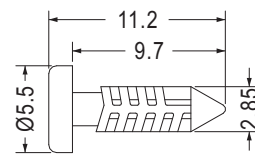

MOUNTING HOLE $\varnothing 3.0$

Part No.	Package
MBW-21	1000



- Material: Nylon 66 (UL)
- Flame Class: 94V-2/94V-0
- Color: Natural/Black
- Unit: mm

用途：用於PC板與機板間固定，省時方便。

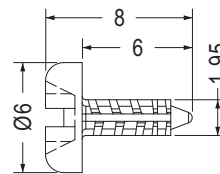

MOUNTING HOLE $\varnothing 2.2$

Part No.	Package
MBW-36	2000

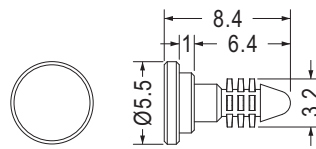

MOUNTING HOLE $\varnothing 3.0$

Part No.	Package
MBW-38	2000

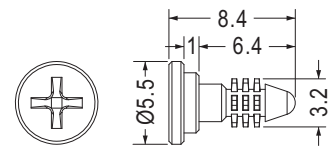

MOUNTING HOLE $\varnothing 3.0$

Part No.	Package
MBW-40	2000



- Material: POM
- Color: White
- Unit: mm

用途：用於木板、鐵板、PC板...等，板子間的結合固定。

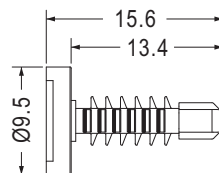

MOUNTING HOLE $\varnothing 3.96$
THICKNESS 0.8~7.92

Part No.	Package
MBW-48	500

螺絲鉚釘 SCREW RIVET

用途：螺絲孔之保護。



- Material: Nylon 66 (UL)
- Flame Class: 94V-2/94V-0
- Color: Natural/Black
- Unit: mm

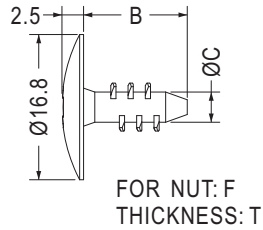

Part No.	B	C	F	T	Package
MBWC-1	12.0	3.5	M6	5.0	1000
MBWC-1-1	12.0	3.45	M6	5.0	
MBWC-4	18.0	3.45	M6	10.0	
MBWC-5	14.0	4.5	M8	5.0	

尼龍鉚釘 SNAP RIVET

用途：用於PC板、鐵板、書本間固定，可調式，結合力強，可搭配BRR1-1使用。



- Material: Nylon 66 (UL)
- Flame Class: 94V-2/94V-0
- Color: Natural/Black
- Unit: mm

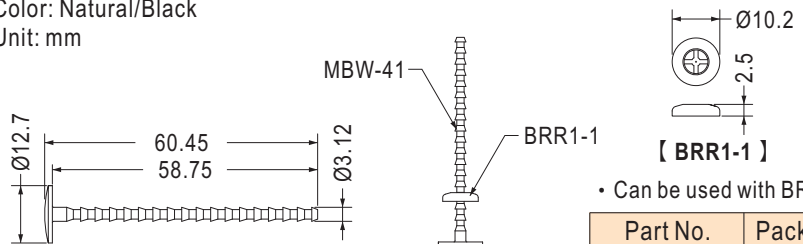

使用示意圖

Part No.	Package
MBW-41	500

散熱片鉚釘 SNAP RIVET

用途：將散熱片固定。



- Material: Nylon 66 (UL)
- Flame Class: 94V-2/94V-0
- Color: Natural/Black
- Unit: mm

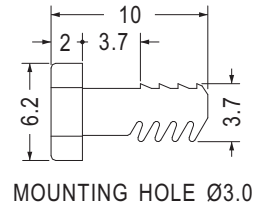

Part No.	Package
MBW3-8	1000

鉚釘 SNAP RIVET

用途：用於PC板與機板間固定，省時方便。



- Material: Nylon 66 (UL)
- Flame Class: 94V-2/94V-0
- Color: Natural/Black
- Unit: mm

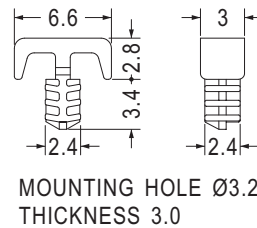

Part No.	Package
MBW-22	1000

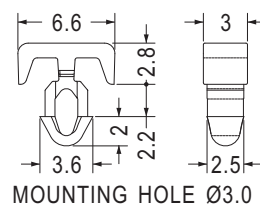

Part No.	Package
MBWB-1	1000

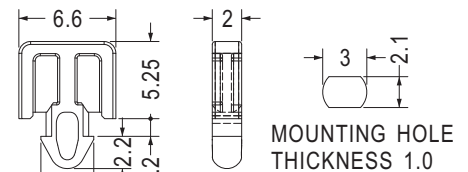

Part No.	Package
MBWB-2	1000

尼龍鉚釘 MOUNTING BUTTON

用途：用於電線固定。

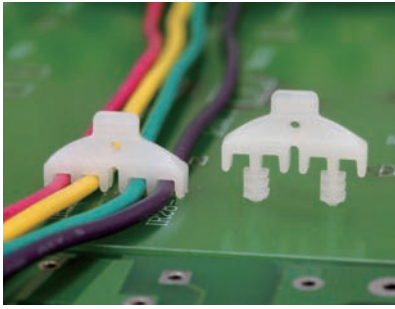

- Material: Nylon 66 (UL)
- Flame Class: 94V-2/94V-0
- Color: Natural/Black
- Unit: mm

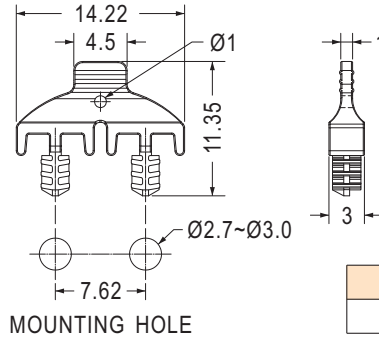

Part No.	Package
MBW-46	1000

塑膠鉚釘 MOUNTING BUTTON

用途：用於機板與機板間之固定，使用方便。

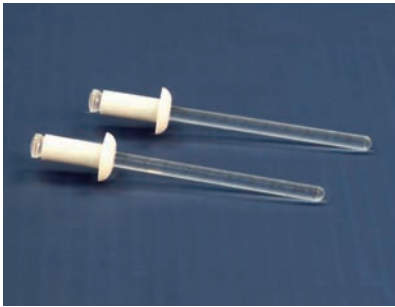

- Material: Nylon 66 (UL)/PC (UL)
- Flame Class: 94V-2/94V-0
- Color: Natural/Black
- Unit: mm



MOUNTING HOLE: ØG
THICKNESS: T
SHEAR FORCE: F (剪斷力) (kg)

Part No.	A	B	C	D	E	F	G	T	Package
CR32-1	3.2	6.4	6.4	1.4	2.1	20.0	Ø3.3	1.0~4.0	500
CR32-2	3.2	9.6	6.4	1.4	2.1	20.0	Ø3.3	4.0~7.0	
CR32-3	3.2	12.7	6.4	1.4	2.1	20.0	Ø3.3	7.0~10.0	
CR40-1	4.0	6.4	8.0	1.8	2.4	25.0	Ø4.1	1.0~4.0	
CR40-2	4.0	9.6	8.0	1.8	2.4	25.0	Ø4.1	4.0~7.0	
CR40-3	4.0	12.7	8.0	1.8	2.4	25.0	Ø4.1	7.0~10.0	
CR48-1	4.8	8.0	9.6	2.0	2.8	40.0	Ø4.9	1.5~5.0	
CR48-2	4.8	11.2	9.6	2.0	2.8	40.0	Ø4.9	5.0~8.0	
CR48-3	4.8	14.4	9.6	2.0	2.8	40.0	Ø4.9	8.0~11.0	
CR56-1	5.6	9.6	12.0	2.2	3.4	65.0	Ø5.7	2.0~5.5	
CR56-2	5.6	12.7	12.0	2.2	3.4	65.0	Ø5.7	5.5~8.5	
CR56-3	5.6	15.9	12.0	2.2	3.4	65.0	Ø5.7	8.5~12.0	

尼龍鉚釘 SNAP RIVET

用途：用於兩片機板間之固定，配合拉釘工具使用。



- Clip Material: Nylon 66 (UL)
- Flame Class: 94V-2/94V-0
- Pin Material: POM
- Color: Black
- Unit: mm

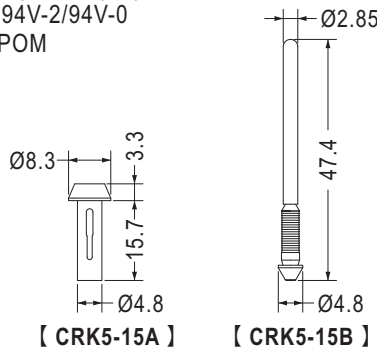

Part No.	組套件(ASSY)	Package
CRK5-15	CRK5-15A+CRK5-15B	500

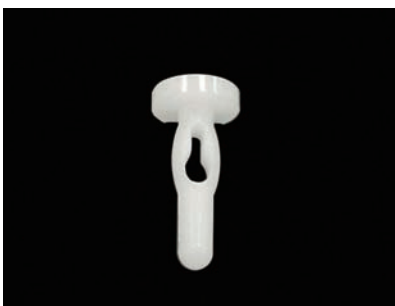

- Material: Nylon 66 (UL)
- Flame Class: 94V-2/94V-0
- Color: Natural/Black
- Unit: mm

用途：用於PC板與機板間固定，省時方便。

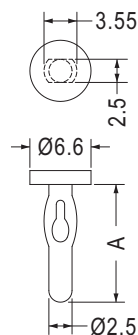

Part No.	A	Package
PIC-10	8.5	1000
PIC-14	12.7	

塑膠鉚釘 MOUNTING BUTTON

用途：用於機板間之固定，使用方便。



- Material: Nylon 66 (UL)
- Flame Class: 94V-2/94V-0
- Color: Natural/Black
- Unit: mm

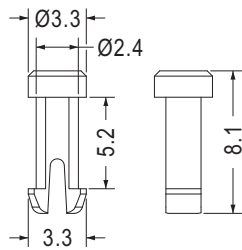

MOUNTING HOLE Ø2.5

Part No.	Package
PNLA-5.2	1000

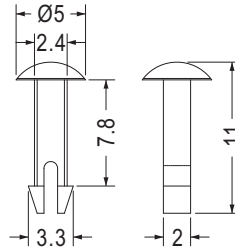

MOUNTING HOLE Ø2.5

Part No.	Package
PNL-7.8	1000

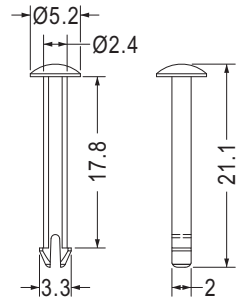

MOUNTING HOLE Ø2.5

Part No.	Package
PNL-17.8	1000

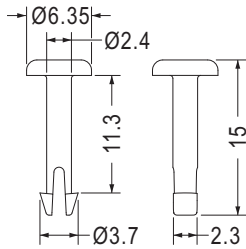

MOUNTING HOLE Ø2.5

Part No.	Package
PNLA-11.4	1000

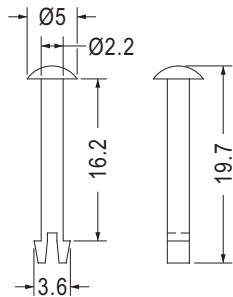

MOUNTING HOLE Ø3.0

Part No.	Package
PNL-18	1000

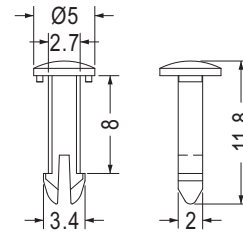

MOUNTING HOLE Ø3.0

Part No.	Package
PNL-8	1000

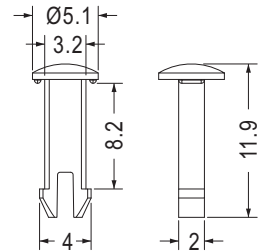

MOUNTING HOLE Ø3.3
THICKNESS 7.7

Part No.	Package
PNL-1	1000

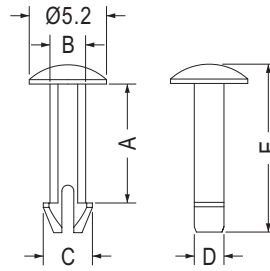

MOUNTING HOLE: ØG

Part No.	A	B	C	D	E	G	Package
PNLS-8	8.0	2.4	3.3	2.0	11.3	2.5	1000
PNLS-15	8.1	2.0	2.7	1.8	11.4	2.3	
PNLS-16	14.5	2.0	2.7	1.8	17.8	2.3	

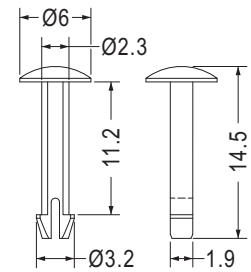

MOUNTING HOLE Ø2.4

- Material: LCP (UL)
- Flame Class: 94V-0
- Color: Natural

Part No.	Package
PNLSA-8	1000

插銷 PIN

用途：PC板與機板間固定，省時方便。



- Material: Nylon 66 (UL)
- Flame Class: 94V-2/94V-0
- Color: Natural/Black
- Unit: mm

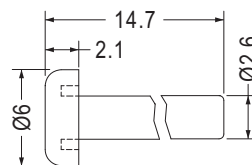

Part No.	Package
CNPS8000	1000

插銷 PIN

用途：配合超音波熱熔，可當螺絲固定。



- Material: ABS (UL)
- Flame Class: 94HB
- Color: Black
- Unit: mm

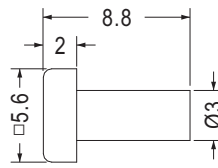

Part No.	Package
ACSR-7	2000



- Material: Nylon 66 (UL)
- Flame Class: 94V-2/94V-0
- Color: Natural/White/Black
- Unit: mm

用途：做為塑膠插銷pin使用。

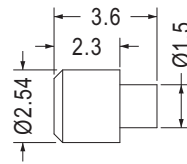

Part No.	Package
BPLTA-3	2000



- Material: PC (UL)
- Flame Class: 94V-2/94V-0
- Color: Transparent
- Unit: mm

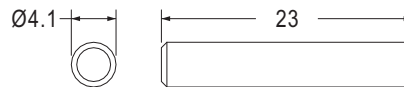

Part No.	Package
EM-579	1000



- Material: POM
- Color: Natural
- Unit: mm

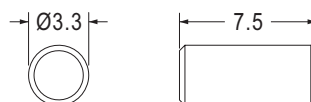

Part No.	Package
PIN3.3-7.5	2000



- Material: PC+ABS (UL)
- Flame Class: 94V-0
- Color: Natural
- Unit: mm

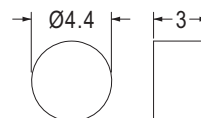

Part No.	Package
PIN4.4-3	2000

- Material: Nylon 66 (UL)
- Flame Class: 94V-2/94V-0
- Color: Natural
- Unit: mm

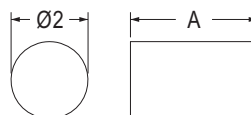

Part No.	A	Package
PIN2-3.3	3.3	2000
PIN2-3.6	3.6	

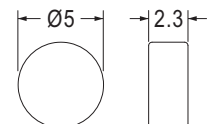

Part No.	Package
PIN5-2.3N	2000

風扇鉚釘 FAN MOUNT RIVET

用途：用於電腦電源風扇之固定，降低噪音、牢固。
G:為45度硬度，H:為55度硬度

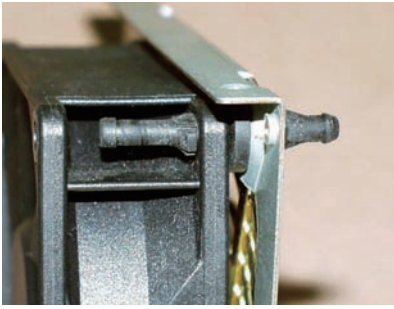

- Material: TPE/TPE (UL)
- G:Hardness is Shore A45
- H:Hardness is Shore A55
- Flame Class: 94V-0
- Color: Black
- Unit: mm

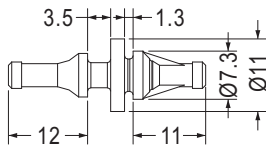
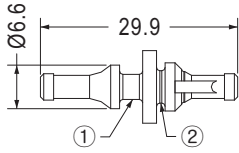

- ① Fan mounting hole $\text{Ø}4.5$ and thickness 3.0~5.5
- ② Support mounting hole $\text{Ø}5.0 \pm 0.1$ and thickness 1.0 ~2.0

Part No.	Package
BUB-30	1000

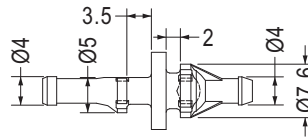
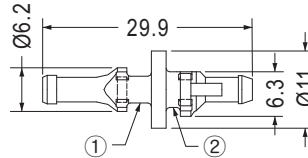

- ① Fan mounting hole $\text{Ø}4.5$ chassis thickness 3.5~4.0
- ② Support mounting hole $\text{Ø}4.5 \sim 4.8$ chassis thickness 0.8~2.0

Part No.	Package
BUB-29	1000

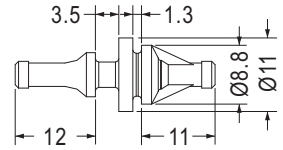
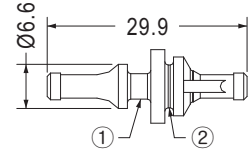

- ① Fan mounting hole $\text{Ø}4.6 \pm 0.2$ and thickness 3.0 ~5.5
- ② Support mounting hole $\text{Ø}6.5 \pm 0.1$ and thickness 1.0~2.0

Part No.	Package
BUB-30L	1000

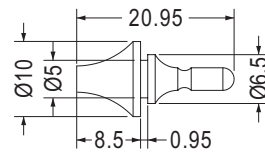

Part No.	Package
BUC-2	1000

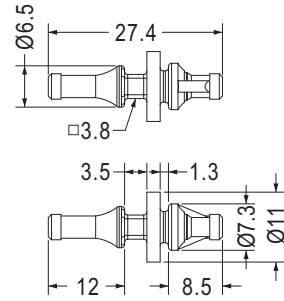

Part No.	Package
BUB-189	1000

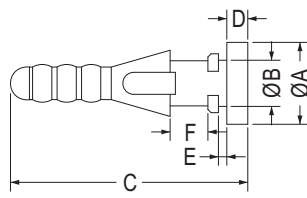
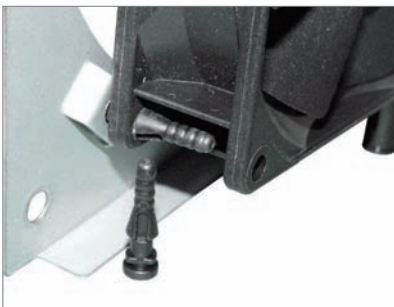

MOUNTING HOLE: ØG

• Color: Black/Blue

Part No.	A	B	C	D	E	F	G	Package
BUB-1	7.8	4.4	22.6	2.0	0.8	3.6	4.3	1000
BUB-5	10.25	4.4	23.0	1.6	1.3	3.0	4.4	
BUB-20	5.8	3.5	20.0	1.5	0.8	3.8	3.5	
BUB-22	7.8	4.4	23.1	2.5	0.8	3.6	4.4	
BUB-23	8.8	4.4	23.0	1.5	0.8	4.5	4.4	
BUB-25	7.8	4.4	23.7	2.5	1.4	3.6	4.4	
BUB-25.4	7.5	4.4	25.4	2.0	4.0	3.0	4.2	
BUB-70	5.8	3.5	70.0	1.5	0.8	27.0	3.5	
BUB-88	8.8	3.5	21.85	1.5	1.0	4.0	3.5	
BUB-88S	7.8	3.5	21.85	1.5	1.0	4.0	3.5	
BUB-151	7.0	4.0	22.85	2.0	1.6	3.8	4.0	
BUB-158	7.8	4.4	23.1	2.5	0.8	3.6	4.4	
BUB-174	8.8	4.4	23.3	1.5	1.1	4.5	4.3	
BUB-199	8.0	4.3	27.0	1.5	1.2	3.8	4.5	

風扇鉚釘 FAN MOUNT RIVET

用途：用於電腦電源風扇之固定，降低噪音、牢固。
G:為45度硬度，H:為55度硬度



- Material: TPE/TPE (UL)
- G:Hardness is Shore A45
- H:Hardness is Shore A55
- Flame Class: 94V-0
- Color: Black
- Unit: mm

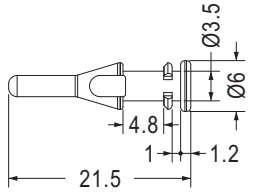

MOUNTING HOLE Ø3.5

Part No.	Package
BUB-234	1000

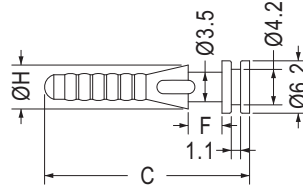

MOUNTING HOLE Ø3.5

Part No.	C	F	H	Package
BUB-194	24.3	4.0	5.2	1000
BUB-205	24.3	4.0	5.0	
BUB-218	25.3	5.0	5.0	

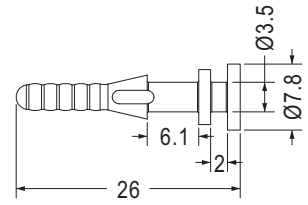

MOUNTING HOLE Ø3.5

Part No.	Package
BUB-231	1000

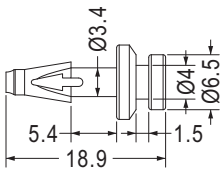

CHASSIS MOUNTING HOLE Ø4.0
FANS MOUNTING HOLE Ø3.5

Part No.	Package
BUB-180	1000

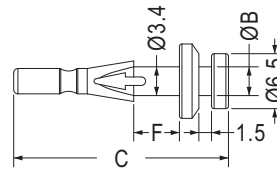

MOUNTING HOLE: ØG
FANS MOUNTING HOLE Ø3.5

Part No.	B	C	F	G	Package
BUB-96	3.4	25.4	5.4	3.5	1000
BUB-96-1	4.0	25.4	5.4	4.0	
BUB-97	3.4	26.4	6.4	3.5	

FANS MOUNTING HOLE Ø4.5
FANS THICKNESS 5.8

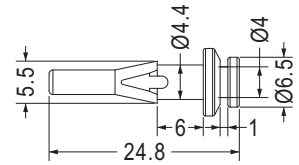

CHASSIS MOUNTING HOLE Ø4.0
CHASSIS THICKNESS 1.0

Part No.	Package
★BUB-243	1000

FAN MOUNTING HOLE Ø3.3
FAN THICKNESS 10.0

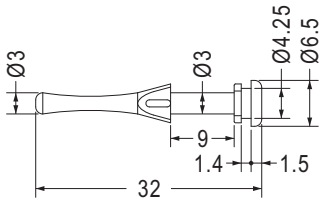

CHASSIS MOUNTING HOLE Ø4.4
CHASSIS THICKNESS 1.2

Part No.	Package
BUB-32	1000

FAN MOUNTING HOLE Ø3.3
FAN THICKNESS 10.0

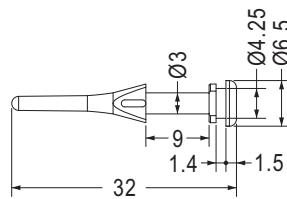

CHASSIS MOUNTING HOLE Ø4.4
CHASSIS THICKNESS 1.2

Part No.	Package
BUB-32S	1000

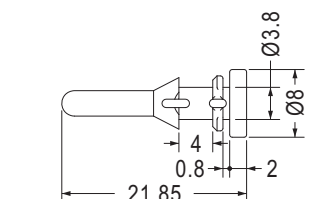

MOUNTING HOLE Ø4.4-Ø4.5
THICKNESS 0.8

Part No.	Package
BUB-182	1000

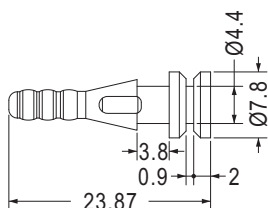

MOUNTING HOLE Ø4.4

Part No.	Package
BUB-152	1000

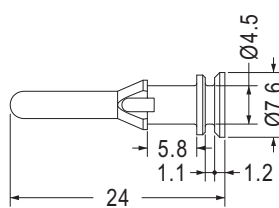

MOUNTING HOLE Ø4.5

Part No.	Package
BUB-202	1000

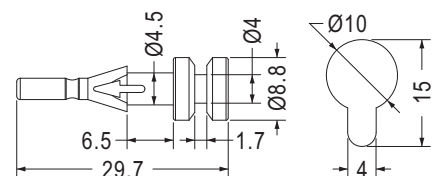

FAN MOUNTING Ø4.5
THICKNESS 6.8

Part No.	Package
BUB-126	1000

風扇鉚釘 FAN MOUNT RIVET

用途：用於電腦電源風扇之固定，降低噪音、牢固。



- Material: TPE/TPE (UL)
- Flame Class: 94V-0
- Color: Black
- Unit: mm

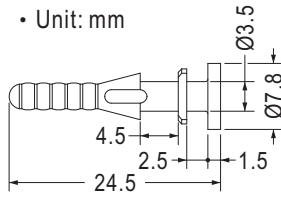

MOUNTING HOLE Ø3.5

Part No.	Package
BUB-209	1000

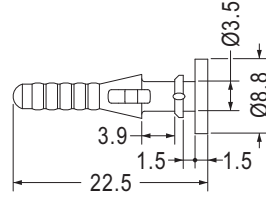

MOUNTING HOLE Ø3.5

Part No.	Package
BUB-213	1000

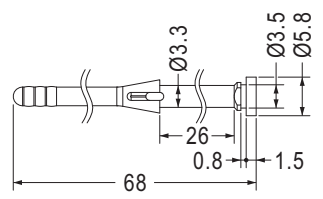

MOUNTING HOLE Ø3.4

Part No.	Package
★BUB-245	1000



- Material: Silicon Rubber
- Color: Black
- Unit: mm

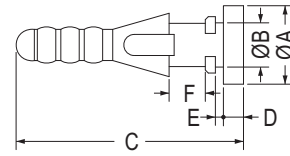

MOUNTING HOLE: ØG

Part No.	A	B	C	D	E	F	G	Package
BUB-231I	8.8	4.4	23.0	1.5	0.8	4.5	4.4	1000
BUB-130I	7.6	4.3	22.2	1.2	0.9	3.9	4.3	

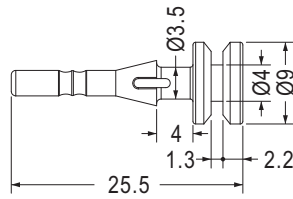

CHASSIS MOUNTING HOLE Ø4.0
FANS MOUNTING HOLE Ø3.5

Part No.	Package
BUB-25.5I	1000

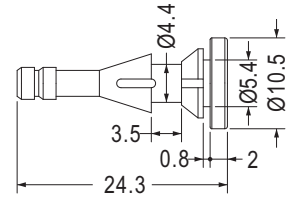

CHASSIS MOUNTING HOLE Ø5.5
FANS MOUNTING HOLE Ø4.5

Part No.	Package
BUB-7I	1000



- Material: TPE/TPE (UL)
- G: Hardness is Shore A45
- H: Hardness is Shore A55
- Flame Class: 94V-0
- Color: Black
- Unit: mm

G: 為45度硬度，H: 為55度硬度

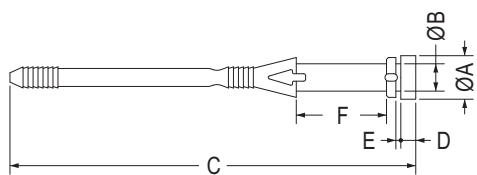

MOUNTING HOLE: ØG

Part No.	A	B	C	D	E	F	G	Package
BUB-9	6.0	3.3	30.9	1.2	1.0	8.0	3.3	1000
BUB-10	6.3	3.5	46.7	1.6	0.8	3.5	3.5	
BUB-35	7.5	4.4	35.0	2.0	1.2	3.0	4.4	
BUB-49	6.3	3.5	48.5	1.6	1.4	3.5	3.5	
BUB-53	7.5	4.4	53.3	2.0	1.2	3.0	4.4	
BUB-54	7.0	4.4	54.1	2.0	2.0	3.0	4.4	
BUB-57	5.2	3.5	57.3	1.5	0.8	19.0	3.5	
BUB-65	7.0	4.4	65.2	2.4	0.8	14.5	4.4	
BUB-65-1	7.0	4.4	62.0	1.7	0.8	14.5	4.4	
BUB-69	7.0	4.4	68.8	1.5	0.8	19.0	4.2	
BUB-71	7.0	4.4	71.0	2.4	1.6	19.5	4.4	
BUB-73	7.0	3.5	73.0	1.4	0.8	26.0	3.5	
BUB-74	7.5	4.4	70.0	2.0	0.8	3.0	4.4	
BUB-85	7.5	4.4	70.0	2.0	0.8	5.0	4.4	
BUB-100	6.0	3.1	55.33	1.7	1.0	18.0	3.3	
BUB-201	7.0	4.0	60.4	1.5	1.5	14.5	4.3	

風扇鉚釘 FAN MOUNT RIVET

用途：用於電腦電源風扇之固定，降低噪音、牢固。
G:為45度硬度，H:為55度硬度

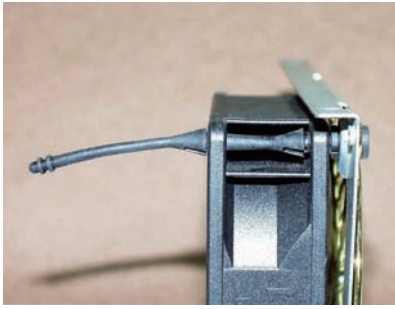

- Material: TPE/TPE (UL)
- G:Hardness is Shore A45
- H:Hardness is Shore A55
- Flame Class: 94V-0
- Color: Black
- Unit: mm

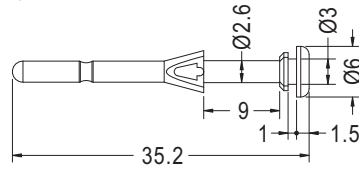

MOUNTING HOLE Ø3.2

Part No.	Package
BUB-127	1000

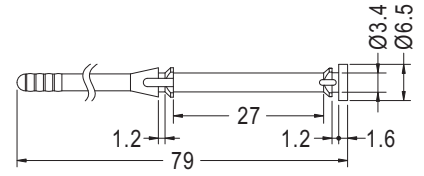

CHASSIS MOUNTING HOLE Ø3.7
FANS MOUNTING HOLE Ø3.5

Part No.	Package
BUB-79	500

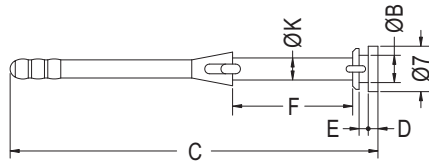

MOUNTING HOLE: ØG

Part No.	B	C	D	E	F	G	K	Package
BUB-48	4.2	48.0	1.4	0.8	3.5	4.4	3.5	1000
BUB-56	4.2	56.7	1.5	1.4	18.5	4.4	3.4	
BUB-76	4.2	75.1	1.4	2.9	26.0	4.4	3.4	
BUB-83	4.4	69.2	1.4	0.8	19.5	4.6	4.0	
BUB-150	3.5	57.3	2.5	0.8	19.0	3.7	3.5	
BUB-150S	3.5	57.2	1.4	0.8	19.0	3.7	3.5	
BUB-153	3.5	74.8	1.4	2.6	26.0	3.7	3.4	
BUB-184	3.96	73.94	0.98	0.91	27.0	4.2	3.4	

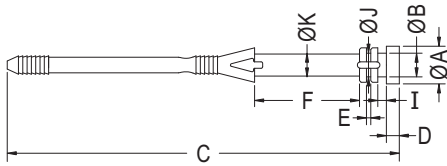

MOUNTING HOLE: ØG

Part No.	A	B	C	D	E	F	G	I	J	K	Package
BUB-4	9.0	4.5	24.7	1.5	1.0	3.5	4.7	1.5	4.0	4.0	1000
BUB-26	8.8	4.4	25.2	1.6	0.8	4.5	4.6	1.6	4.4	4.4	
BUB-68	8.0	4.0	68.0	1.5	1.0	4.0	4.2	1.5	4.0	4.0	
BUB-72	7.0	4.4	72.0	2.4	0.8	19.5	4.7	1.6	4.4	4.1	

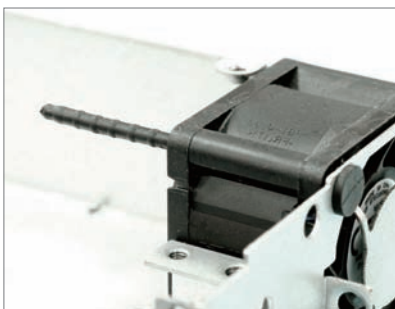

HOLE IN FAN Ø3.5
THICKNESS 10.0

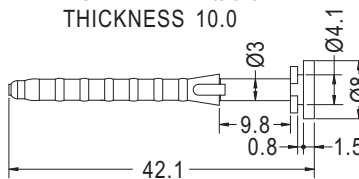

MOUNTING HOLE Ø4.4
THICKNESS 0.8~1.0

Part No.	Package
BUB-179	1000

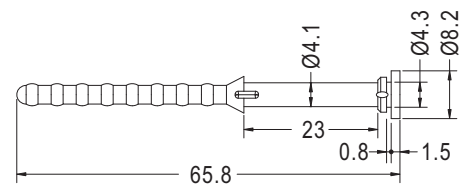

MOUNTING HOLE Ø4.4

Part No.	Package
BUB-66	1000

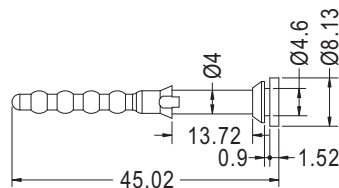

MOUNTING HOLE Ø5.5
THICKNESS 0.9

Part No.	Package
BUB-175L	1000

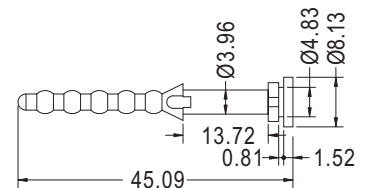

MOUNTING HOLE Ø5.1

Part No.	Package
BUB-45	1000

風扇鉚釘 FAN MOUNT RIVET

用途：用於電腦電源風扇之固定，降低噪音、牢固。
G:為45度硬度，H:為55度硬度



- Material: TPE/TPE (UL)
- G:Hardness is Shore A45
- H:Hardness is Shore A55
- Flame Class: 94V-0
- Color: Black
- Unit: mm

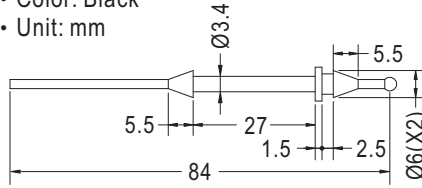

MOUNTING HOLE Ø4.3

Part No.	Package
BUB-159	1000

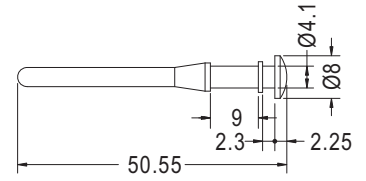

MOUNTING HOLE Ø4.3

Part No.	Package
BUB-225	1000

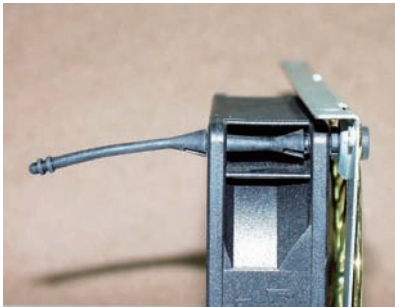

- Material: Silicon Rubber
- Color: Black
- Unit: mm

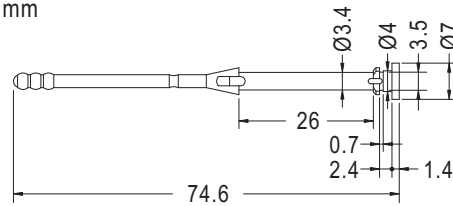

MOUNTING HOLE Ø3.5

Part No.	Package
BUB-211I	1000

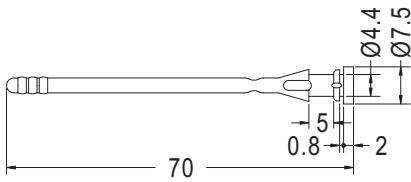

MOUNTING HOLE Ø4.5

Part No.	Package
BUB-85I	1000

HOLE IN FAN Ø3.5
THICKNESS 28.0

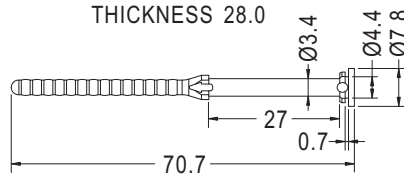

MOUNTING HOLE Ø4.5
THICKNESS 0.8

Part No.	Package
BUB-161I	1000

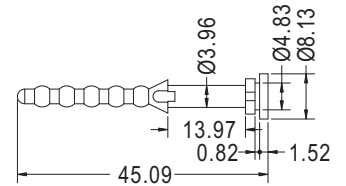

MOUNTING HOLE Ø5.1

Part No.	Package
BUB-45I	1000



HOLE IN FAN Ø4.4
THICKNESS 15.0

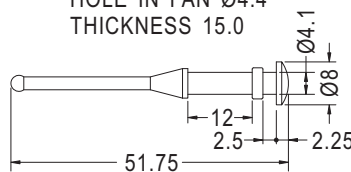

MOUNTING HOLE Ø4.4
THICKNESS 2.5

Part No.	Package
TF-268I	1000



- Material: Silicon Rubber (UL)
- Flame Class: 94V-0
- Color: Black
- Unit: mm

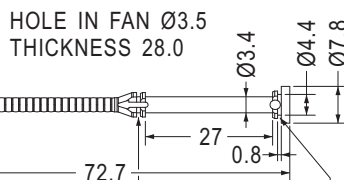

MOUNTING HOLE Ø3.5
THICKNESS 0.8

MOUNTING HOLE Ø4.5
THICKNESS 0.8

Part No.	Package
BUB-235I	1000

風扇鉚釘 FAN MOUNT RIVET

用途：用於電腦電源風扇之固定，降低噪音、牢固。
G:為45度硬度，H:為55度硬度



- Material: TPE/TPE (UL)
- G:Hardness is Shore A45
- H:Hardness is Shore A55
- Flame Class: 94V-0
- Color: Black
- Unit: mm

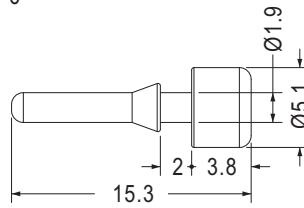

MOUNTING HOLE Ø2.0

Part No.	Package
BUB-138	1000

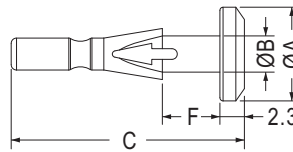

MOUNTING HOLE : ØG

Part No.	A	B	C	F	G	Package
BUB-136	8.8	3.4	21.9	5.4	3.5	1000
BUB-172	8.5	4.1	22.0	4.5	4.5	

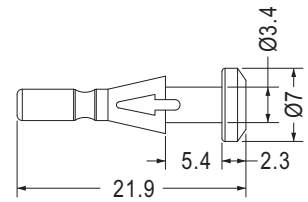

MOUNTING HOLE Ø3.6

• Material: Silicon Rubber

Part No.	Package
BUB-219I	1000

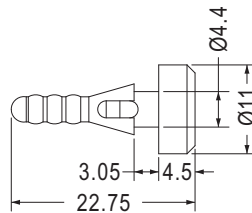

MOUNTING HOLE Ø4.3
THICKNESS 4.0

Part No.	Package
BUB-155	1000

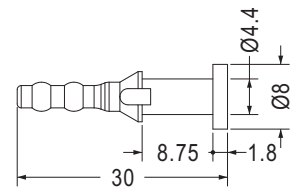

MOUNTING HOLE Ø4.4~Ø4.5

Part No.	Package
BUB-196	1000

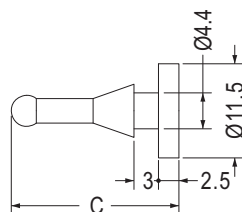

MOUNTING HOLE Ø4.6

Part No.	C	Package
BUB-90	20.5	1000
BUB-124	40.5	

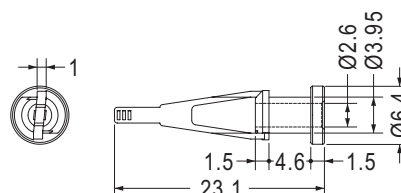

MOUNTING HOLE Ø4.2

Part No.	Package
BUB-95	1000

風扇鉚釘 FAN MOUNT RIVET

用途：用於電腦電源風扇之固定，降低噪音、牢固。
G:為45度硬度，H:為55度硬度



- Material: TPE/TPE (UL)
- G:Hardness is Shore A45
- H:Hardness is Shore A55
- Flame Class: 94V-0
- Color: Black
- Unit: mm

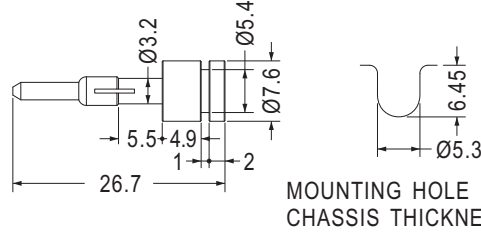

Part No.	Package
BUB-139	1000

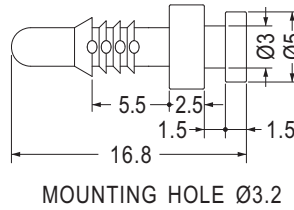

Part No.	Package
BUB-16.7	1000

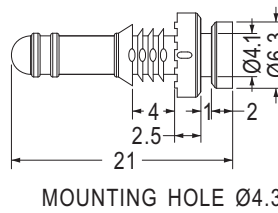

MOUNTING HOLE Ø4.3

Part No.	Package
BUB-171	1000

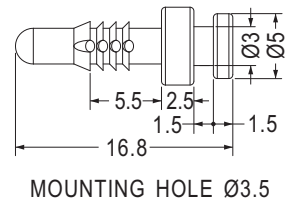

MOUNTING HOLE Ø3.5

Part No.	Package
BUB-177	1000

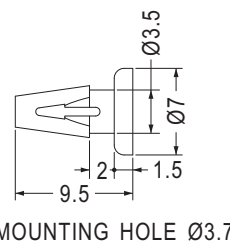

MOUNTING HOLE Ø3.7

Part No.	Package
BUB-132	1000

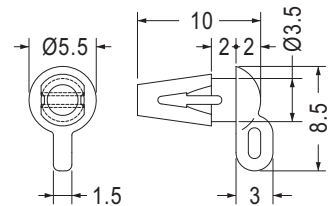

MOUNTING HOLE Ø3.7

Part No.	Package
BUB-133	1000



- Material: TPE (UL)
- Flame Class: 94V-0
- Color: Black
- Unit: mm

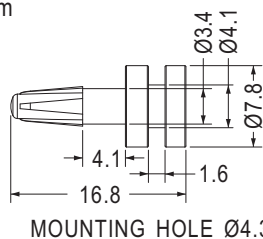

MOUNTING HOLE Ø4.3

Part No.	Package
BUB-217	1000

- Material: TPR
- Color: Black
- Unit: mm

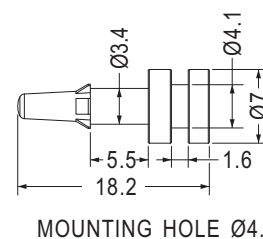

MOUNTING HOLE Ø4.3

Part No.	Package
BUB-233	1000

風扇鉚釘 FAN MOUNT RIVET

用途：用於電腦電源風扇之固定，降低噪音、牢固。



- Material: Silicon Rubber
- Color: Black
- Unit: mm

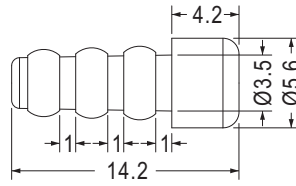

MOUNTING HOLE Ø4.5

Part No.	Package
BUB-86I	1000

塑膠鉚釘 MOUNTING BUTTON

用途：用於風扇鉚釘之固定。



- Material: Nylon 66 (UL)
- Flame Class: 94V-2/94V-0
- Color: Black
- Unit: mm
- Patented (專利品)

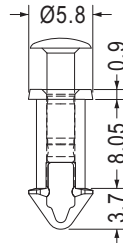

MOUNTING HOLE Ø4.4~Ø4.5
THICKNESS 8.0

Part No.	Package
SRMKA-8	1000

風扇鉚釘 FAN MOUNT RIVET

用途：用於電腦電源風扇之固定，降低噪音、牢固。



- Body Material: TPE
- Pin Material: Nylon 66 (UL)
- Flame Class: 94V-2
- Color: Black
- Unit: mm

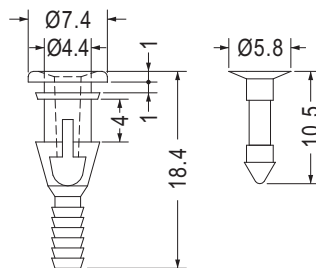

MOUNTING HOLE Ø4.8~Ø5.0

Part No.	Package
FSP-1	1000

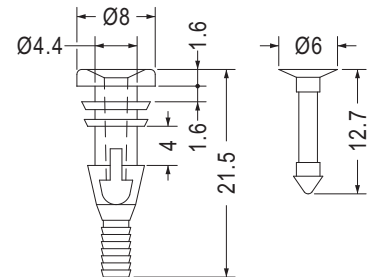

MOUNTING HOLE Ø4.8~Ø5.0

Part No.	Package
FSP-2	1000

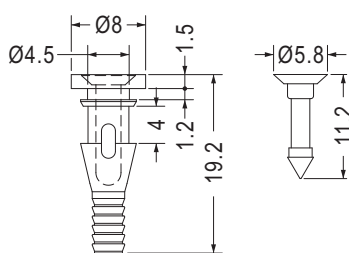

MOUNTING HOLE Ø4.5

Part No.	Package
FSP-3	1000

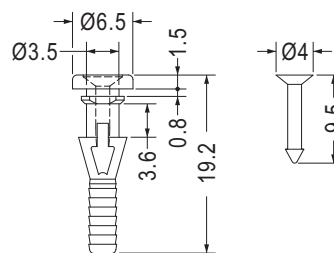

MOUNTING HOLE Ø3.5

Part No.	Package
FSP-10	1000

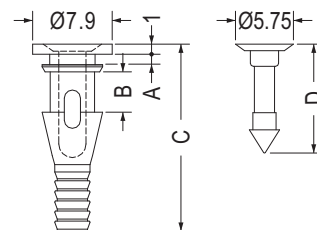

MOUNTING HOLE: ØG

Part No.	A	B	C	D	G	Package
FSP-4	1.05	3.9	18.55	10.8	4.5~4.7	1000
FSP-5	0.9	3.9	14.3	10.8	4.5~4.7	
FSP-6	1.6	5.0	20.1	12.1	4.5	

風扇鉚釘 FAN MOUNT RIVET

用途：用於電腦電源風扇之固定，降低噪音、牢固。



- Material: TPE
- Pin Material: Nylon 66 (UL)
- Flame Class: 94V-2
- Color: Black
- Unit: mm

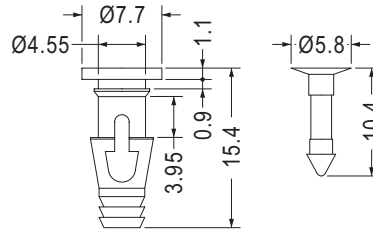

MOUNTING HOLE Ø4.5-Ø4.7

Part No.	Package
FSP-9	1000

散熱片扣件 HEAT SINK RIVET

用途：用於兩片零件間之固定。

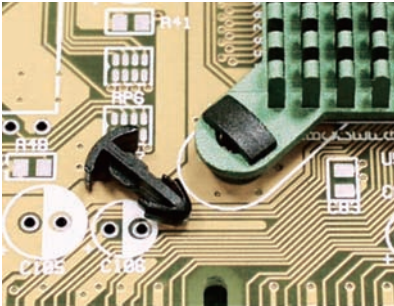

- Material: Nylon 66 (UL)
- Flame Class: 94V-2/94V-0
- Color: Natural/Black
- Unit: mm

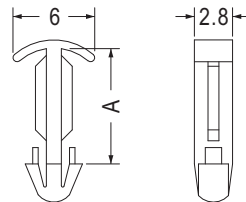

MOUNTING HOLE Ø3.0

Part No.	A	Package
MBB-6	6.0	2000
MBB-7	7.0	
MBB-8	8.0	

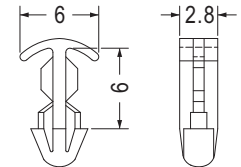

MOUNTING HOLE Ø3.0

Part No.	Package
MBB-6A	2000

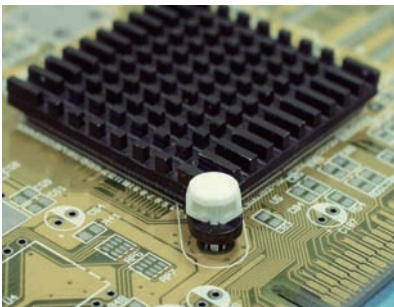

- Material: Nylon 66 (UL)
- Flame Class: 94V-2/94V-0
- Color: Natural/Black
- Unit: mm

用途：用於PC板上與IC散熱片間固定，方便、牢固。

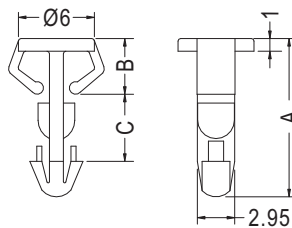

MOUNTING HOLE Ø3.0

Part No.	A	B	C	Package
MCC-1	12.5	4.4	5.3	2000
MCC-2	12.7	5.3	4.7	
MCC-3	10.3	5.0	2.5	

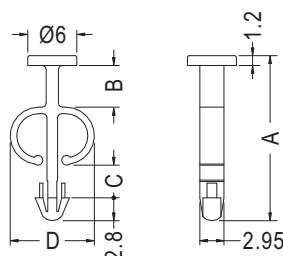

MOUNTING HOLE Ø3.0

Part No.	A	B	C	D	Package
MEE-1	20.3	5.1	4.0	10.1	1000
MEE-2	17.0	2.5	3.4	10.3	

散熱片扣件 HEAT SINK RIVET

用途：用於PC板上與IC散熱片間固定，方便、牢固。

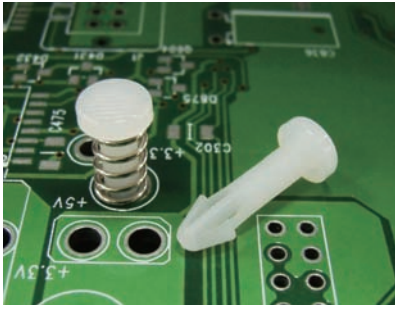

- Material: Nylon 66 (UL)
- Flame Class: 94V-2/94V-0
- Color: Natural/Black
- Unit: mm

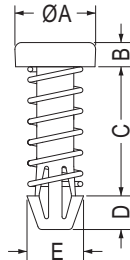

P.C.B: ØG

- PC板Ø3.0散熱片孔徑建議開Ø3.2
- PC板Ø3.5散熱片孔徑建議開Ø3.7
- PC板Ø4.0散熱片孔徑建議開Ø4.2~Ø4.3
- 彈簧尺寸可依客戶訂製

Applications: Use on PC Boards and affix Heat Sinks, stable and easy to use.

- PC Boards Ø 3.0, suggests for a Heat Sink of Ø 3.2 in diameter.
- PC Boards Ø 3.5, suggests for a Heat Sink of Ø 3.7 in diameter.
- PC Boards Ø 4.0, suggests for a Heat Sink of Ø 4.2 - 4.3 in diameter.
- Custom spring sizes are available upon request.

Part No.	A	B	C	D	E	G	Package
HSR-4	4.3	1.5	11.5	2.5	4.3	3.0	1000
HSR-6	6.4	1.5	8.7	2.5	4.3	3.0	
HSR-6S	6.35	1.5	8.7	2.5	4.0	3.0	
HSR-7	6.4	1.5	10.6	2.5	4.3	3.0	
HSR-9	6.4	1.5	11.5	2.5	4.4	3.0	
HSR-10	5.0	1.75	8.3	2.5	4.3	3.0	
HSR-11	6.4	2.75	21.0	2.5	4.3	3.0	
HSR-12	5.5	1.5	8.7	3.6	4.0	3.0	
HSR-13	6.2	1.0	7.8	2.5	4.2	3.0	
HSR-16	6.3	1.5	11.5	2.1	4.2	3.0	
HSR-23	6.4	1.5	11.4	2.6	4.3	3.0	
HSR-24	5.5	1.5	14.0	2.8	4.1	3.0	
HSR-25	5.5	1.6	11.4	3.0	4.0	3.0	
HSR-26	6.4	1.5	11.5	2.5	4.8	3.5	
HSR-30	5.0	1.75	12.32	2.5	4.3	3.0	
HSR-31	6.4	1.5	11.4	2.5	4.5	3.0	
HSR-32	5.5	1.5	9.0	1.9	3.6	3.0	
HSR-33	6.4	1.5	11.4	2.5	4.8	3.5	
HSR-34	6.0	1.9	17.6	2.5	4.2	3.0	
HSR-35	6.2	1.0	9.0	2.5	4.3	3.0	
HSR-41	5.5	1.5	10.0	2.5	4.3	3.0	
HSR-42	5.5	1.5	12.0	2.5	4.3	3.0	
HSR-44	5.5	1.5	9.0	3.5	4.3	3.0	
HSR-45	6.5	1.5	11.1	3.5	5.4	4.0	
HSR-49	6.3	0.8	5.7	2.1	4.2	3.0	
HSR-50	6.2	1.0	7.0	2.5	4.3	3.0	

Part No.	A	B	C	D	E	G	Package
HSR-51	8.0	1.6	16.5	3.3	5.5	4.0	1000
HSR-53	5.5	1.0	7.4	2.1	4.2	3.0	
HSR-56	6.5	1.5	11.1	3.5	5.15	4.0	
HSR-57	5.5	0.8	6.6	2.1	4.2	3.0	
HSR-61	4.7	1.2	12.7	2.0	3.6	2.7	
HSR-62	6.3	1.5	25.5	2.7	4.0	3.0	
HSR-64	6.4	1.5	10.6	2.5	4.3	3.0	
HSR-65	5.5	1.5	9.0	1.9	3.8	3.2	
HSR-66	6.5	1.5	22.7	3.85	5.35	4.0	
HSR-68	6.2	1.2	11.0	1.5	4.3	3.0	
HSR-72	5.5	1.5	11.0	1.9	3.6	3.0	
HSR-73	8.0	1.5	15.85	2.7	5.5	4.0	
HSR-83	5.8	1.5	17.0	1.7	4.3	3.0	
HSR-85	8.0	1.5	15.8	4.0	5.5	4.0	
HSR-93	6.4	1.6	12.7	2.8	4.3	3.0	
HSR-95	8.0	1.6	15.5	3.3	5.3	3.8	
HSR-96	6.4	1.8	14.0	3.3	4.0	3.0	
HSR-97	6.2	1.2	13.5	1.3	4.3	3.0	
HSR-98	5.5	0.8	8.4	2.1	4.2	3.0	
HSR-110	6.2	1.0	7.4	2.5	4.3	3.05	
HSR-112	6.2	1.2	11.0	2.5	4.3	3.05	
HSR-118	6.4	1.5	12.8	2.5	4.3	3.05	
★HSR-120	4.3	1.5	11.5	3.5	4.3	3.05	
HSR-121	6.4	1.5	9.9	2.5	4.0	2.85	

散熱片扣件 HEAT SINK RIVET

用途：用於PC板上與IC散熱片間固定，方便、牢固。

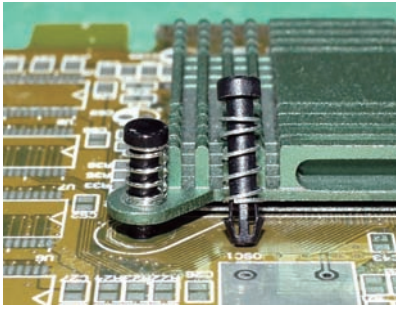

- Material: Nylon 66 (UL)
- Flame Class: 94V-2/94V-0
- Color: Natural/Black
- Unit: mm

- PC板Ø2.5散熱片孔徑建議開Ø2.7
- PC板Ø2.7散熱片孔徑建議開Ø2.9
- PC板Ø3.0散熱片孔徑建議開Ø3.2
- 彈簧尺寸可依客戶訂製

Applications: Use on PC Boards and affix Heat Sinks, stable and easy to use.

- PC Boards Ø 2.5, suggests for a Heat Sink Of Ø 2.7 in diameter
- PC Boards Ø 2.7, suggests for a Heat Sink Of Ø 2.9 in diameter
- PC Boards Ø 3.0, suggests for a Heat Sink Of Ø 3.2 in diameter
- Custom spring sizes are available upon request

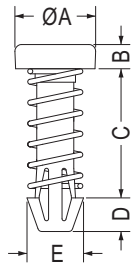

P.C.B: ØG

Part No.	A	B	C	D	E	G	Package
HSR-14	4.6	5.9	13.0	3.5	4.2	3.0	1000
HSR-29	6.4	0.9	9.5	3.3	4.0	3.0	
HSR-55	6.0	1.8	9.6	2.5	4.0	3.0	
HSR-91	4.7	1.2	11.8	2.0	3.6	2.7	



- Material: Nylon 66 (UL)
- Flame Class: 94V-2/94V-0
- Color: Natural/Black
- Unit: mm

- PC板Ø3.0散熱片孔徑建議開Ø3.2
- PC板Ø3.5散熱片孔徑建議開Ø3.7
- PC板Ø4.0散熱片孔徑建議開Ø4.2~Ø4.3
- 彈簧尺寸可依客戶訂製

Applications: Use on PC Boards and affix Heat Sinks, stable and easy to use.

- PC Boards Ø 3.0, suggests for a Heat Sink of Ø 3.2 in diameter
- PC Boards Ø 3.5, suggests for a Heat Sink of Ø 3.7 in diameter
- PC Boards Ø 4.0, suggests for a Heat Sink of Ø 4.2 - 4.3 in diameter
- Custom spring sizes are available upon request

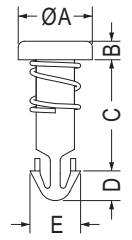

P.C.B: ØG

Part No.	A	B	C	D	E	G	Package
HSR-12.7	6.4	1.6	12.7	3.2	4.2	3.0	1000
HSR-38	6.0	1.5	9.0	2.4	4.1	3.2	
HSR-60	6.3	0.8	5.7	2.7	4.2	3.0	

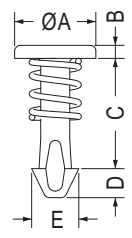

P.C.B: ØG

Part No.	A	B	C	D	E	G	Package
HSR-37	5.0	1.0	10.0	2.0	2.0	1.5	1000
HSR-39	5.6	1.2	12.7	2.0	3.1	2.3	
HSR-40	4.7	1.2	12.4	2.0	3.1	2.3	
HSR-48	5.6	0.9	7.6	2.1	3.3	2.2	
HSR-54	5.6	0.9	11.6	2.0	3.3	2.2	
HSR-67	5.0	1.0	10.0	2.0	2.2	1.7	
HSR-71	4.7	1.2	12.4	1.5	3.1	2.3	
HSR-89	4.5	0.9	7.7	2.0	3.3	2.2	



- Material: Nylon 66 (UL)
- Flame Class: 94V-2/94V-0
- Color: Natural/Black
- Unit: mm

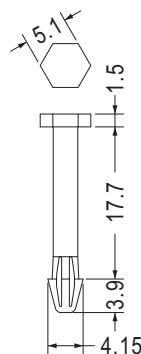

Part No.	Package
HSR-103	1000

HOLE IN P.C.B Ø3.0
HOLE HEAT SINK Ø3.2~Ø3.4

散熱片扣件 HEAT SINK RIVET

用途：用於PC板上與IC散熱片間固定，方便、牢固。



- Material: Nylon 66 (UL)
- Flame Class: 94V-2/94V-0
- Color: Natural/Black
- Unit: mm

- PC板 $\varnothing 3.0$ 散熱片孔徑建議開 $\varnothing 3.2$
- Applications: Use on PC Boards and affix Heat Sinks, stable and easy to use.
- PC Boards $\varnothing 3.0$, suggests for a Heat Sink Of $\varnothing 3.2$ in diameter

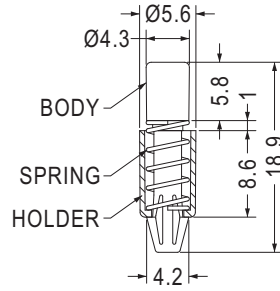

HOLE IN P.C.B $\varnothing 3.0$
HOLE IN HEAT SINK $\varnothing 3.2$

Part No.	Package
HSR-1	1000

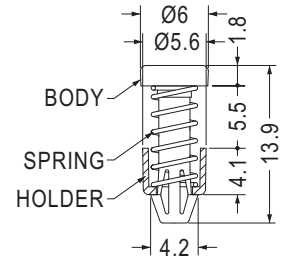

HOLE IN P.C.B $\varnothing 3.0$
P.C.B THICKNESS 1.2~1.7

Part No.	Package
HSR-2	1000

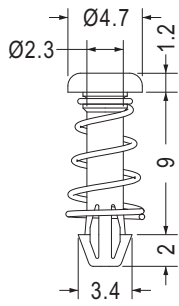

P.C.B $\varnothing 2.5$

Part No.	Package
HSR-36	1000

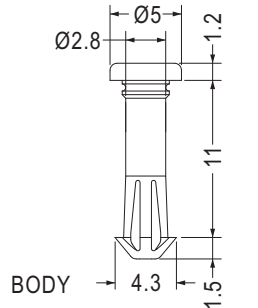

HOLE IN P.C.B $\varnothing 3.05$
HOLE IN HEAT SINK $\varnothing 3.2$

Part No.	Package
HSR-109	1000

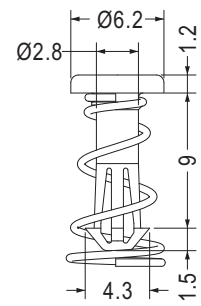

P.C.B $\varnothing 3.0$

Part No.	Package
HSR-74-201	1000

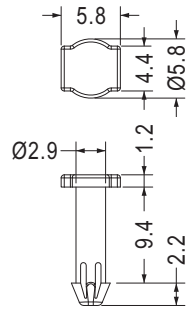

HOLE IN P.C.B $\varnothing 3.0$
HOLE HEAT SINK $\varnothing 3.2$

Part No.	Package
HSR-90	1000

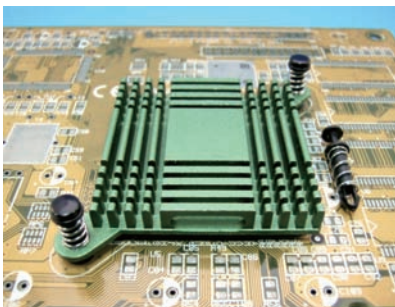

HOLE IN P.C.B $\varnothing 3.5$
THICKNESS 1.6

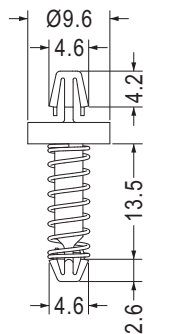

HOLE IN P.C.B $\varnothing 3.5$

Part No.	Package
HSR-58	1000

P.C.B $\varnothing 3.3$
THICKNESS 1.6

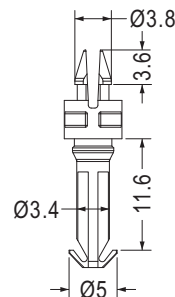

P.C.B $\varnothing 4.0$
THICKNESS 0.8~1.0

Part No.	Package
HSRD-2	1000

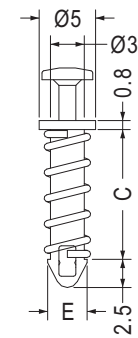

MOUNTING HOLE $\varnothing 3.0$

Part No.	C	E	Package
SRMK-8.5	8.5	3.7	1000
SRMK-11.5	11.5	3.5	

- Material: Nylon 66 (UL)
- Flame Class: 94V-2/94V-0
- Color: Natural/Black
- Unit: mm

插銷 PIN



- Material: Nylon 66 (UL)
- Flame Class: 94V-2/94V-0
- Color: Natural/White/Black
- Unit: mm
- Patented (專利品)

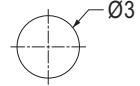
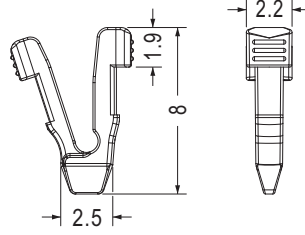

RECOMMEND MOUNTION HOLE
RECOMMEND THICKNESS 2.0

Part No.	Package
MBTA-1	2000

用途：加強散熱片銅插銷之固定，避免震動脫落。

喇叭座 SPEAKER HOLDER

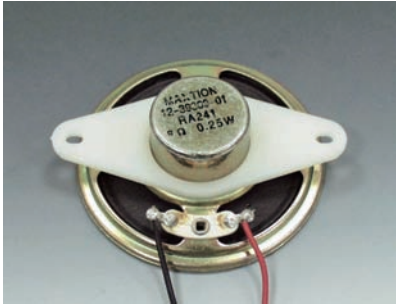

- Material: Nylon 66 (UL)
- Flame Class: 94V-2/94V-0
- Color: Natural/Black
- Unit: mm

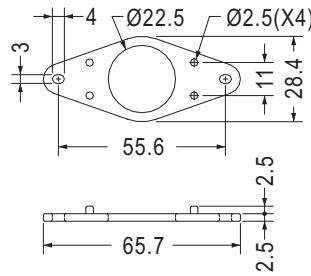

Part No.	Package
SPK-1	250

用途：將Ø50喇叭固定於機板上。

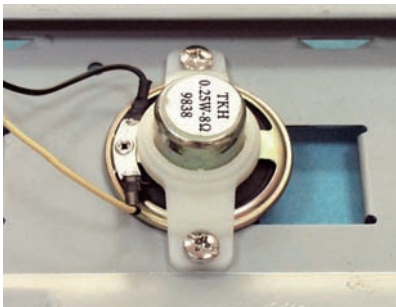

- Material: Nylon 66 (UL)
- Flame Class: 94V-2/94V-0
- Color: Natural/Black
- Unit: mm

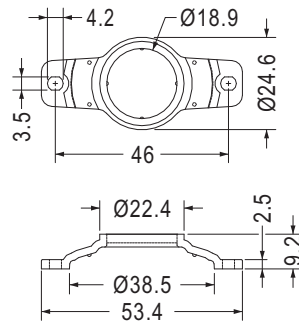

Part No.	Package
SPK-2	250

用途：將Ø38喇叭固定於機板上。

喇叭箱扣 SPEAKER BOX BUCKLE



- Body Material: TPE
- Pin Material: Nylon 66 (UL)
- Flame Class: 94V-2/94V-0
- Color: Black
- Unit: mm

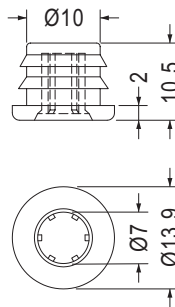

BODY

MOUNTING HOLE Ø10.5
THICKNESS 2.5

Part No.	Package
SPLK-1FA	500

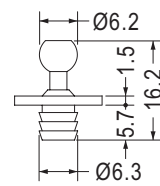
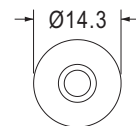

PIN

MOUNTING HOLE Ø6.1
THICKNESS 6.4

Part No.	Package
SPLK-1FB	500

用途：固定音箱外蓋用。

喇叭箱扣 SPEAKER BOX BUCKLE

用途：固定音箱外蓋用。



- Body Material: TPU
- Pin Material: Nylon 66 (UL)
- Flame Class: 94V-2/94V-0
- Color: Black
- Unit: mm

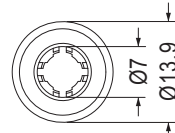
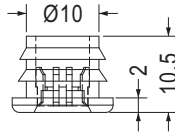

MOUNTING HOLE Ø10.5
THICKNESS 2.5

Part No.	Package
SPLK-2FA	500

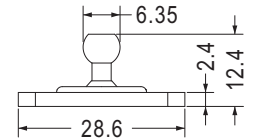
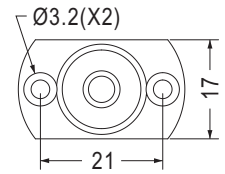

PIN

Part No.	Package
SPLK-2FB	500

門扣擋銷 DOOR LOCK TIP

用途：用於面板固定用。



- Body Material: POM
- Pin Material: Nylon 66 (UL)
- Flame Class: 94V-2/94V-0
- Color: Black
- Unit: mm

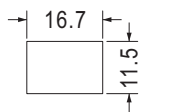
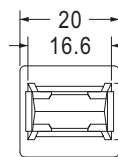

MOUNTING HOLE
THICKNESS 1.6~1.8

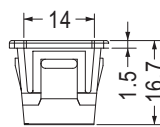

門扣本體
DOOR LOCK BODY

Part No.	Package
DTTL-1A	500

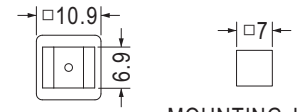

MOUNTING HOLE
THICKNESS 1.2~1.5

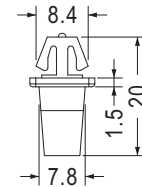

PIN

Part No.	Package
DTTL-1B	500

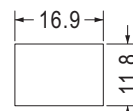
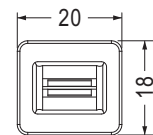

MOUNTING HOLE
THICKNESS 0.8~1.2

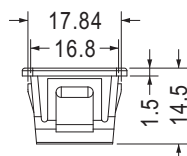

門扣本體
DOOR LOCK BODY

Part No.	Package
DTTL-3A	500

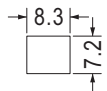
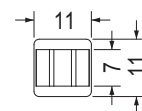

MOUNTING HOLE
THICKNESS 0.8~1.2

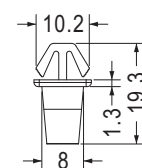

PIN

Part No.	Package
DTTL-3B	500

門扣擋銷 DOOR LOCK TIP

用途：用於面板固定用。



- Material: Nylon 66 (UL)
- Flame Class: 94V-2/94V-0
- Color: Natural
- Unit: mm

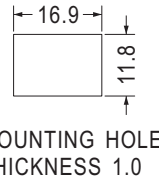
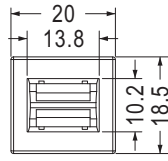

MOUNTING HOLE THICKNESS 1.0

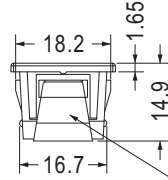

【 DTLL-7AF 】

CLAMP STEEL ZINC PLATED

- Material: POM

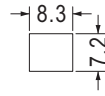
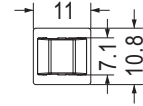

MOUNTING HOLE THICKNESS 0.8~1.2

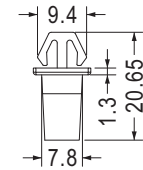

【 DTLL-7B 】

Part No.	Part No.	Package
DTTL-7	DTTL-7AF	250
	DTTL-7B	
此為子母包:內容物包含右方零件		



- Material: Nylon 66 (UL)
- Flame Class: 94V-2/94V-0
- Color: Black
- Unit: mm

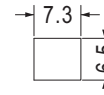
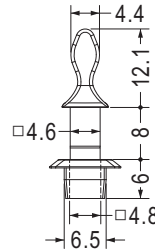
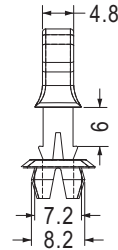

MOUNTING HOLE THICKNESS 0.8~1.5

Part No.	Package
DTTL-4	500

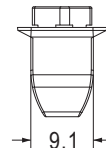
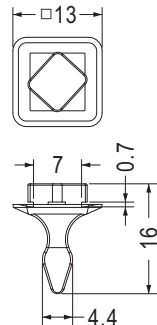

MOUNTING HOLE THICKNESS 0.8

Part No.	Package
DTTL-5B	500

固定扣 SNAP LATCH

用途：固定於機器上，牢固結合不脫落。



- Material: Nylon 66 (UL)
- Flame Class: 94V-2/94V-0
- Color: Natural/Black
- Unit: mm

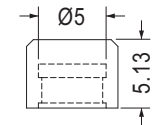
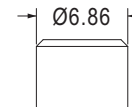
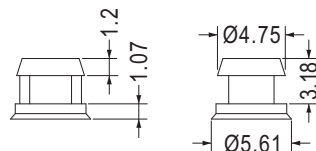

Part No.	Package
LO-6052A	1000

Part No.	Package
LO-6052B	1000

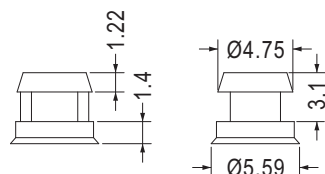

Part No.	Package
LO-6053A	1000

固定扣 SNAP LATCH

用途：固定於機器上，牢固結合不脫落。



- Material: Nylon 66 (UL)
- Flame Class: 94V-2/94V-0
- Color: Natural/Black
- Unit: mm

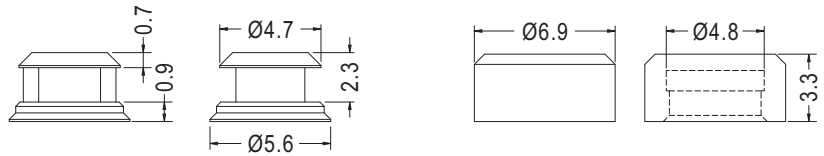

Part No.	Package
LO-6055A	1000

Part No.	Package
LO-6055B	1000

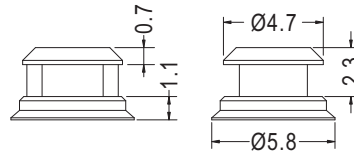

Part No.	Package
LO-6056A	1000

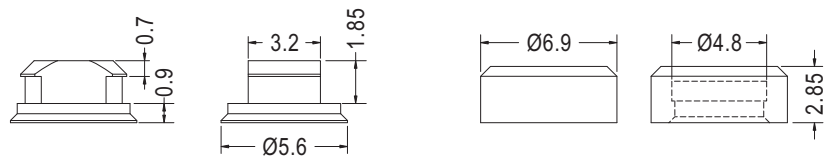

Part No.	Package
LO-6057A	1000

Part No.	Package
LO-6057B	1000

零件座 PARTS HOUSING

用途：用於零件座。

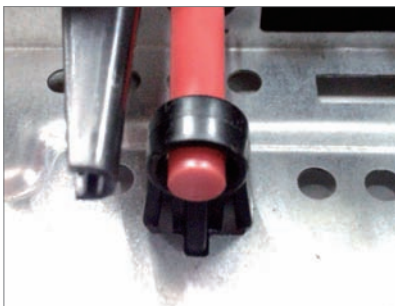

- Material: PS
- Color: Black
- Unit: mm

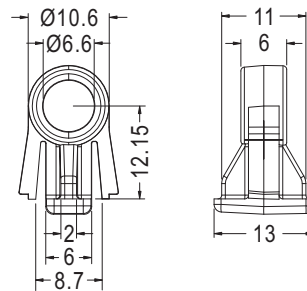

Part No.	Package
EMU-5	1000

門扣 DOOR LOCK

用途：用於機器之開關門扣，方便機器門之開與關。



- Catcher Material: Nylon 66 (UL)/94V-2
- Case Material: POM (UL)/94HB
- Color: Black
- Unit: mm

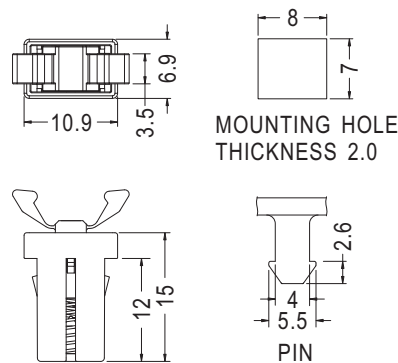

Part No.	Package
DT-1	500

門扣 DOOR LOCK

用途：用於機器之開關門扣，方便機器門之開與關。

- Catcher Material: Nylon 66 (UL)/94V-2
- Case Material: POM (UL)/94HB
- Color: Black
- Unit: mm

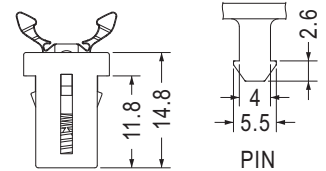
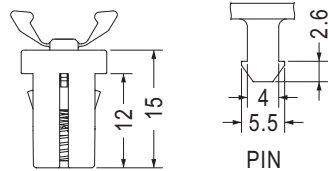
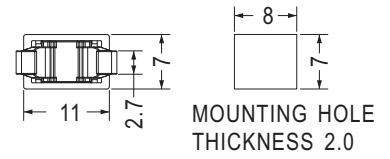
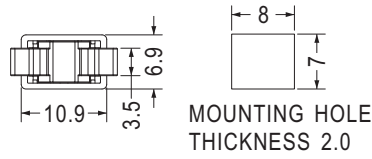

Part No.	Package
DT-18	500

Part No.	Package
DT-51	500

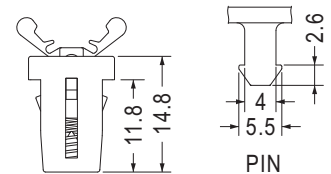
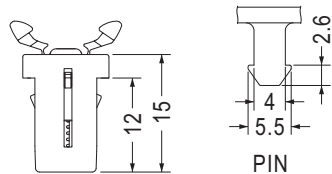
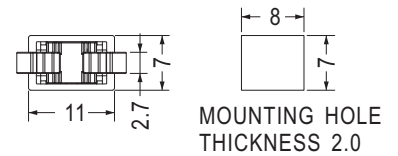
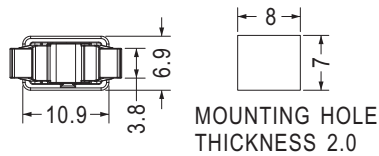

Part No.	Package
DT-16	500

Part No.	Package
DT-4	500

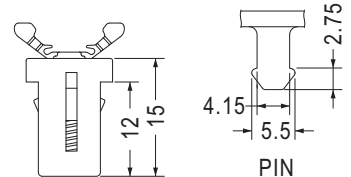
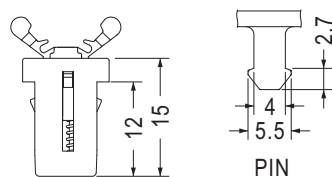
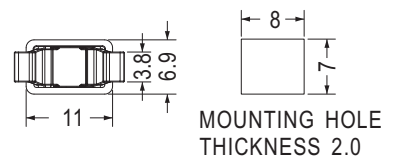
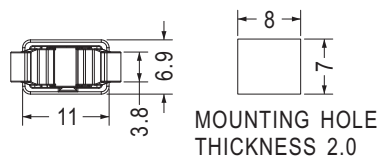

Part No.	Package
DT-19	500

Part No.	Package
DT-21	500

門扣 DOOR LOCK

用途：用於機器之開關門扣，方便機器門之開與關。



- Catcher Material: Nylon 66 (UL)/94V-2
- Case Material: POM (UL)/94HB
- Color: Black
- Unit: mm

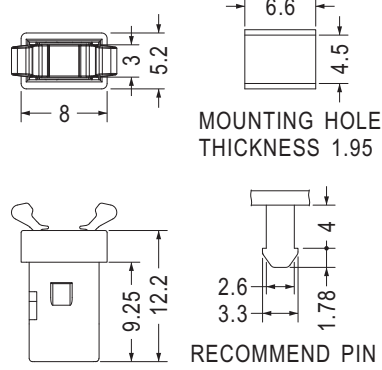

Part No.	Package
DT-22	500



- Material: Nylon 66 (UL)
- Flame Class: 94V-2/94V-0
- Color: Black
- Unit: mm

用途：可配合DT-22之門扣，方便機器門之開與關。

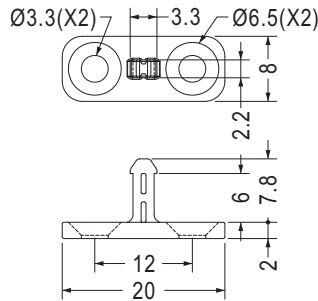

Part No.	Package
DTA-4	500



- Material: ABS (UL)
- Flame Class: 94HB
- Color: Black
- Unit: mm

用途：可配合DT-1之門扣，方便機器門之開與關。

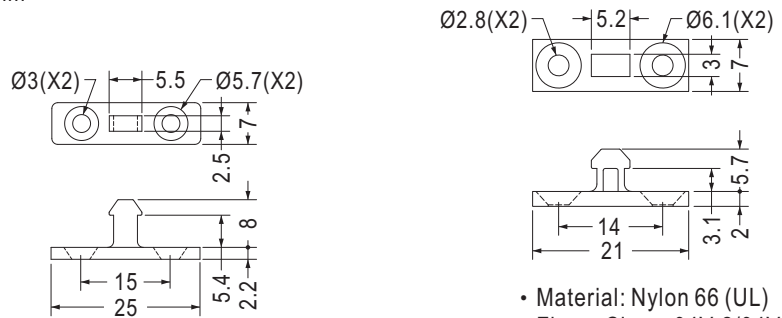

Part No.	Package
DTA-1	500

Part No.	Package
DTA-3	500

- Material: Nylon 66 (UL)
- Flame Class: 94V-2/94V-0



- Catcher Material: Nylon 66 (UL)/94V-2
- Case Material: POM (UL)/94HB
- Color: Black
- Unit: mm

用途：用於機器之開關門扣，方便機器門之開與關。

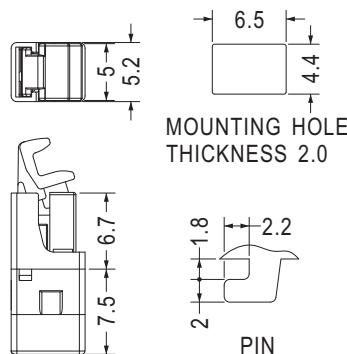

Part No.	Package
DT-12	500

門扣 DOOR LOCK

用途：用於機器之開關門扣，方便機器門之開與關。



- Catcher Material: Nylon 66 (UL)/94V-2
- Case Material: POM (UL)/94HB
- Color: Black
- Unit: mm

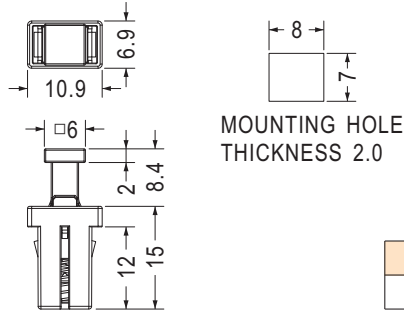

Part No.	Package
DT-14	500



- Material: Nylon 66 (UL)
- Flame Class: 94V-2/94V-0
- Color: Black
- Unit: mm

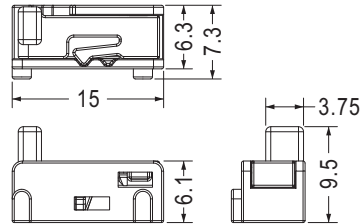

Part No.	Package
DT-50	500



- Material: Nylon 66 (UL)
- Flame Class: 94V-2/94V-0
- Color: Black
- Unit: mm

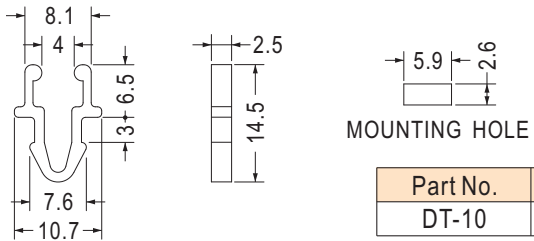

Part No.	Package
DT-10	2000



- Material: Nylon 66 (UL)
- Flame Class: 94V-2/94V-0
- Color: Black
- Unit: mm

用途：用於機器之合鈕，方便機器門之開與關。

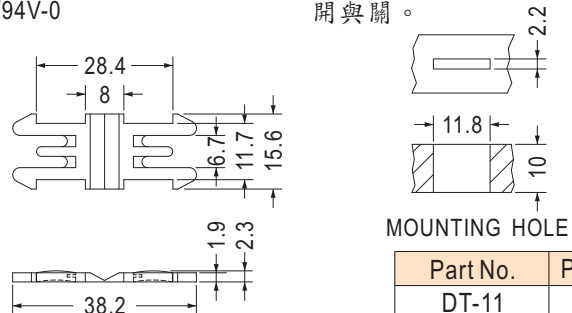

Part No.	Package
DT-11	500



- Material: Nylon 66 (UL)
- Flame Class: 94V-2/94V-0
- Color: Black
- Unit: mm

用途：用於機器之開關門扣，方便機器門之開與關。

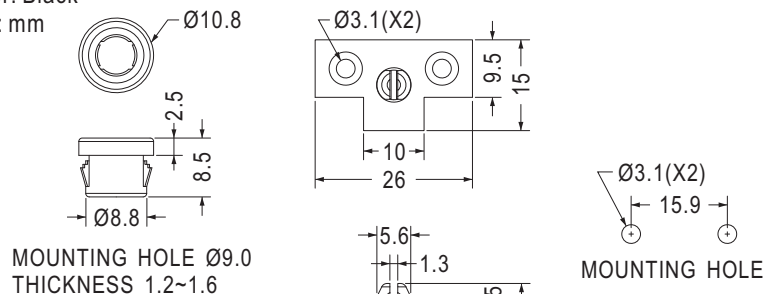

Part No.	Package
DT-48A	1000

Part No.	Package
DT-48B	1000

門扣擋銷 DOOR LOCK TIP

用途：用於機器之開關門扣，方便機器門之開與關。



- Material: Nylon 66 (UL)
- Flame Class: 94V-2/94V-0
- Color: Natural/Black
- Unit: mm

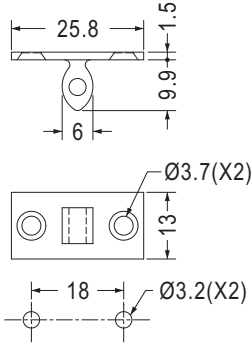

MOUNTING HOLE

Part No.	Package
DTA-42	500

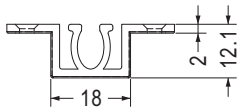
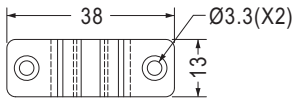

MOUNTING HOLE

- Material: POM
- Color: Natural

Part No.	Package
DT-49	500

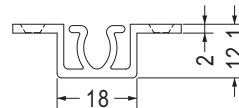
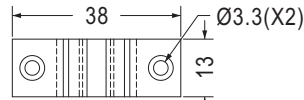

MOUNTING HOLE

- Material: POM (UL)
- Flame Class: 94HB
- Color: Natural

Part No.	Package
DT-42	500



- Material: ABS (UL)
- Flame Class: 94HB
- Color: Natural
- Unit: mm

用途：用於面板固定用。

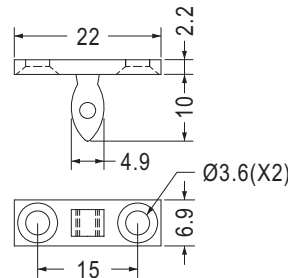

門扣擋梢
DOOR LOCK PIN

Part No.	Package
DT-45A	500

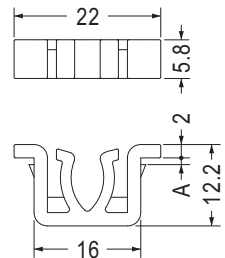

門扣本體
DOOR LOCK BODY

Part No.	A	Package
DT-45B	1.0	500
DT-45BL	1.1	



- Material: POM (UL)
- Flame Class: 94HB
- Color: Natural
- Unit: mm

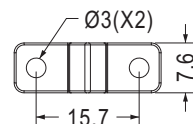
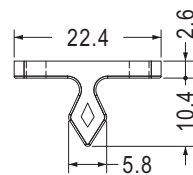

Part No.	Package
DT-46A	500

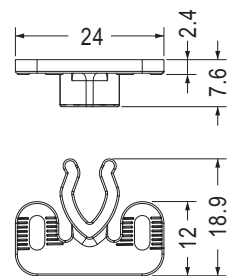

Part No.	Package
DT-46B	500



門扣擋銷 DOOR LOCK TIP



- Material: Nylon 66 (UL)
- Flame Class: 94V-2/94V-0
- Color: Natural/Black
- Unit: mm

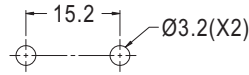
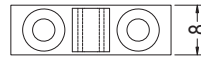
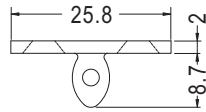

MOUNTING HOLE

Part No.	Package
DT-43A	500

用途：用於面板固定用。

- Material: POM
- Color: Natural
- Unit: mm

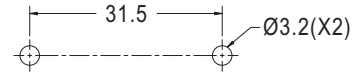
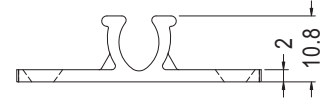
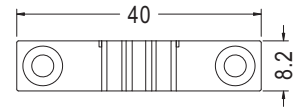

MOUNTING HOLE

Part No.	Package
DT-43B	500

門扣 DOOR LOCK



- Material: Nylon 66 (UL)
- Flame Class: 94V-2/94V-0
- Color: Natural/Black
- Unit: mm

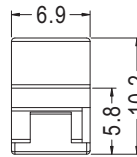
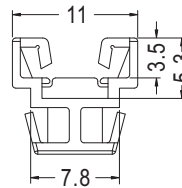

用途：用於機器之開關門扣，方便機器門之開與關，可配合DTA-1使用。

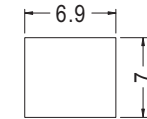

MOUNTING HOLE
THICKNESS 2.0

Part No.	Package
DT-47B	1000

彈簧固定座 SPRING POSITION MOUNT



- Material: Nylon 66 (UL)
- Flame Class: 94V-2/94V-0
- Position Pin Material: POM
- Color: Black
- Unit: mm
- Patented (專利品)

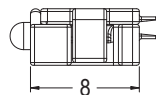
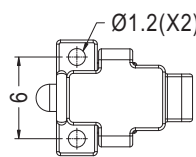
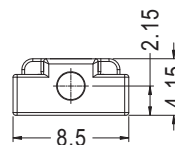

用途：用於旋轉機構角度定位。

Part No.	Part No.	Package
DTB-1F	DTB-1A	1000
	DTB-1B	
	SPG-504	

磁鐵門扣 MAGNET DOOR LOCK



- Material: Nylon 66 (UL)
- Flame Class: 94V-2/94V-0
- Clip Material: SPCC
- Color: Black
- Unit: mm

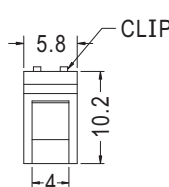
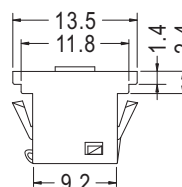

用途：用於機器之開關門扣磁性強，方便機器門之開與關。

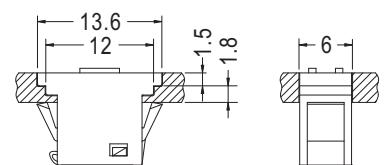

MOUNTING HOLE

Part No.	Package
DTM-1	500

磁鐵門扣 MAGNET DOOR LOCK

用途：用於機器之開關門扣磁性強，方便機器門之開與關。



- Material: Nylon 66 (UL)
- Flame Class: 94V-2/94V-0
- Clip Material: SPCC
- Color: Black
- Unit: mm

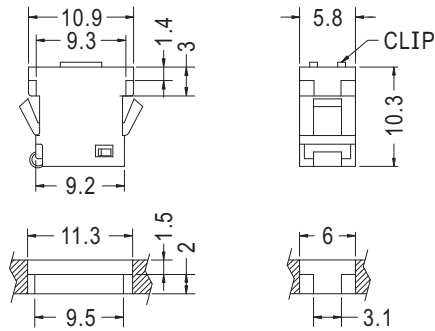

Part No.	Package
DTM-2	500

MOUNTING HOLE

旋轉型門扣 DOOR LOCK

用途：固定於兩片鐵板，一般用於機器的門扣，拆卸方便。



- Material: Nylon 66 (UL)
- Flame Class: 94V-2/94V-0
- Color: Black
- Unit: mm

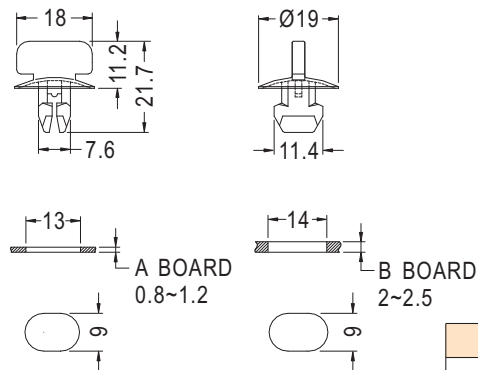

Part No.	Package
TF-1	200

MOUNTING HOLE

十字型插件式固定器 PLUG-IN SWITCH CROSS TYPE

用途：用於零件的扣件。



- Material: POM
- Color: Black
- Unit: mm

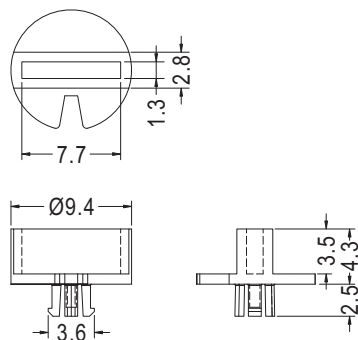

Part No.	Package
EM-349	1000

軌道固定器 RAIL MOUNT

用途：用於軌道的固定。



- Material: Nylon 66 (UL)
- Flame Class: 94V-2/94V-0
- Color: Natural/Black
- Unit: mm

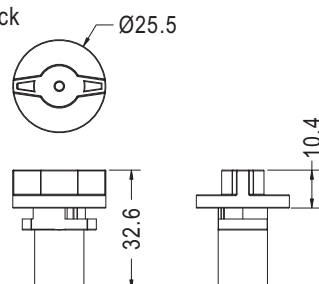

Part No.	Package
EM-710	100

固定扣 SNAP LATCH



- Material: PC (UL)
- Flame Class: 94V-2
- Color: Black
- Unit: mm

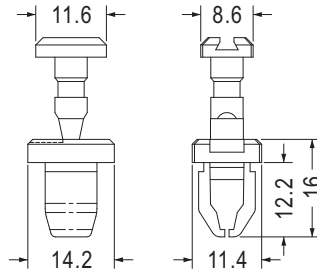

用途：固定於兩片鐵板，一般用於機器
的門扣，拆卸方便。

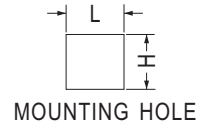
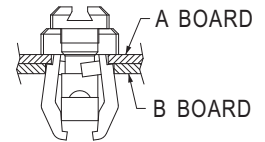

Part No.	Package
TFA-2	500

A Board	MOUNTING HOLE (LxH): 9x9 THICKNESS: 1.2~1.5
B Board	MOUNTING HOLE (LxH): 9.5x9 THICKNESS: 1.2~2.5

螺絲固定座 PLASTIC CONICAL ANCHORS



- Material: Nylon 66 (UL)
- Flame Class: 94V-2/94V-0
- Color: Natural/Black
- Unit: mm
- Drill Size: 3/16(Ø4.8)

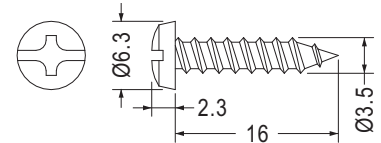
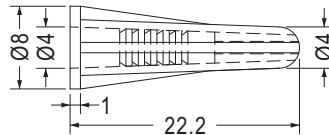

用途：用於螺絲與牆壁固定，結合力強。

Part No.	Color	Package
PCA-1	Natural	1000
PCA-1(R)	Red	

Part No.	Package
STP-3.5	1000

- Material: Steel
- Finish: Nickel Plated

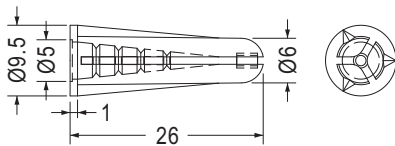

- Drill Size: Ø6.3

Part No.	Package
PCA-4	1000

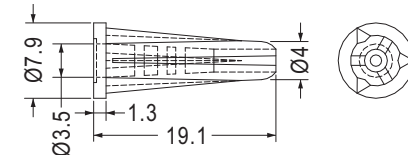

Part No.	Package
PCA-6	1000

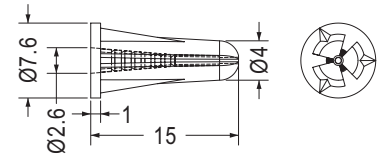

Part No.	Package
PCA-8	1000

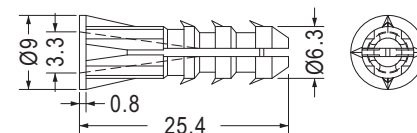

- Material: PP
- Color: Black/Gray
- Drill Size: Ø6.3

Part No.	Package
PCA-2	1000

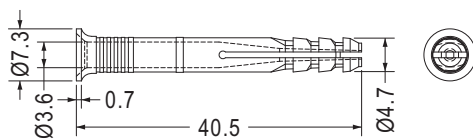

- Drill Size: Ø4.8

Part No.	Package
PCA-5	1000

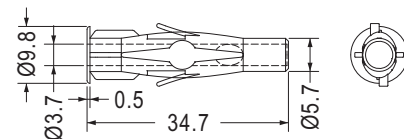

- Color: Natural/Black/Gray
- Drill Size: Ø6.3

Part No.	Package
PCA-7	1000

螺絲固定座 PLASTIC CONICAL ANCHORS

用途：用於螺絲與牆壁固定，結合力強。



- Material: PP
- Color: Natural/Yellow
- Unit: mm
- Drill Size: Ø6.35

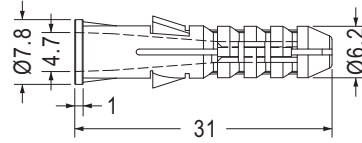

Part No.	Package
PCA-9	1000



- Material: PP
- Color: Natural
- Unit: mm
- Drill Size: Ø6.3

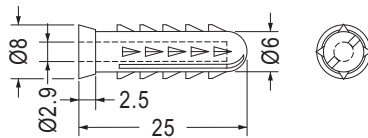

Part No.	Package
PEB3-25	1000

- Material: Nylon 66 (UL)/PP
- Flame Class: 94V-2/94V-0
- Color: Natural/White/Black
- Unit: mm

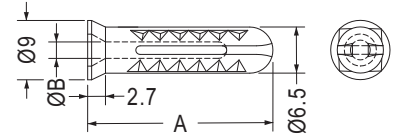

Part No.	A	B	Package
PEC5-28	28.1	2.5	1000
PEC5-30	30.0	3.1	



- Material: PP/PE
- Color: Natural/White
- Unit: mm

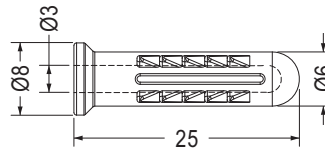

Part No.	Package
PEBR-1	1000



- Material: Nylon 66 (UL)/PP (UL)
- Flame Class: 94HB/94V-2/94V-0
- Color: Natural/White/Black/Gray
- Unit: mm

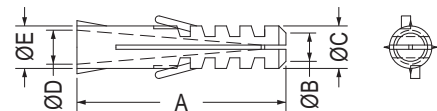

Part No.	A	B	C	D	E	Package
PEB4-20	20.1	2.8	4.0	2.9	4.0	1000
PEB6-25	24.7	3.5	4.8	4.0	5.0	
PEB6-30	29.6	4.0	6.0	4.8	6.0	
PEB6-31	29.6	3.5	6.0	4.0	6.0	

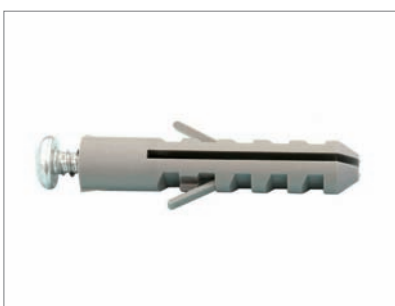

- Material: PP
- Color: Gray
- Unit: mm

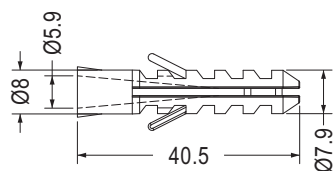

Part No.	Package
PEB5-40.5	1000

可與STP5-32自攻螺絲配合使用

螺絲固定座 PLASTIC CONICAL ANCHORS

用途：用於螺絲與牆壁固定，結合力強。

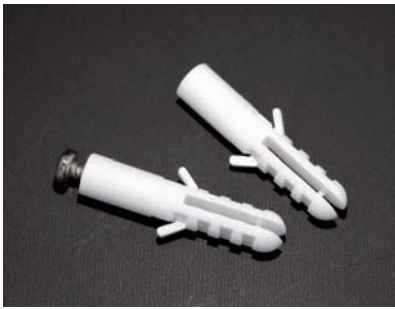

- Material: PP
- Color: Natural
- Unit: mm

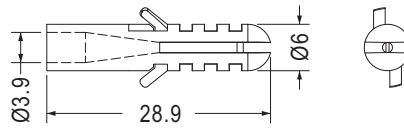

MOUNTING HOLE Ø6.35

Part No.	Package
PEB4-29	1000

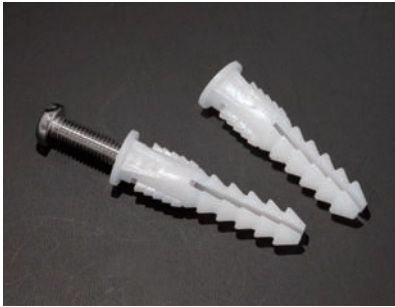

- Material: PP/Nylon 66 (UL)
- Flame Class: 94V-2/94V-0
- Color: Natural
- Unit: mm

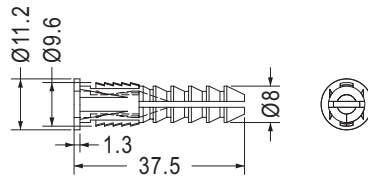

可與STP5-32自攻螺絲配合使用

Part No.	Package
PEB8-38	1000

- Material: Nylon 66 (UL)
- Flame Class: 94V-2/94V-0
- Color: Natural/Black
- Unit: mm

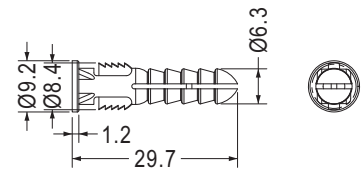

Part No.	Package
PEB4-30	1000

石膏板固定座 PLASTIC CONICAL ANCHORS

用途：用於螺絲與石膏牆壁固定，結合力強。



- Material: PBT (UL)
- Flame Class: 94V-0
- Color: White
- Unit: mm

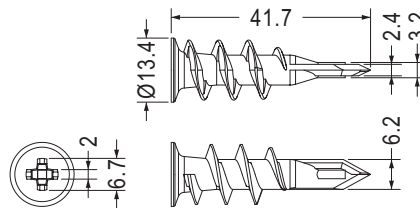

Part No.	Package
WMEZ-1	1000

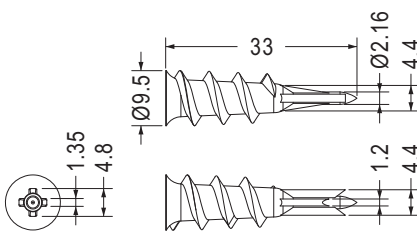

Part No.	Package
WMEZ-2	1000

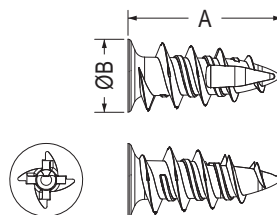

Part No.	A	B	Package
WMEZ-3	25.0	11.8	1000
WMEZ-4	37.6	14.9	1000

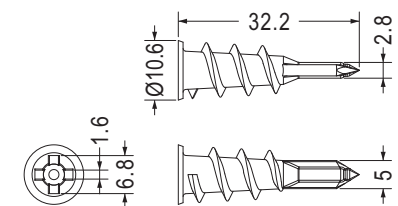

- Material: Nylon 66 (UL)
- Flame Class: 94V-2

Part No.	Package
★ WMEZ-5	1000



- Material: PP
- Color: Natural
- Unit: mm

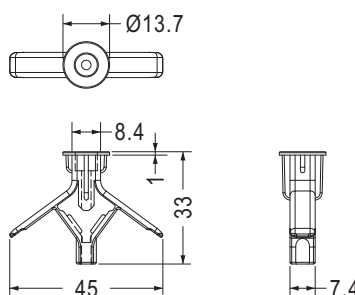

MOUNTING HOLE Ø9.5

Part No.	Package
WMEA-1	1000

防水帽蓋 WATERPROOF CAP

用途：用於零件之防水蓋。



- Material: TPV
- Color: Black
- Unit: mm

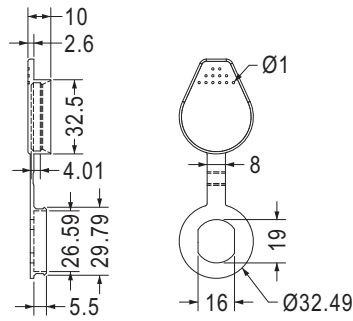

Part No.	Package
EMS-1	100

帽蓋連接帶 CAP WITH CONNECTING TIE

用途：用於零件接頭之防水，中間有連接，避免防塵蓋遺失。



- Material: Nylon 66 (UL)/PE
- Flame Class: 94HB
- Color: Black
- Unit: mm

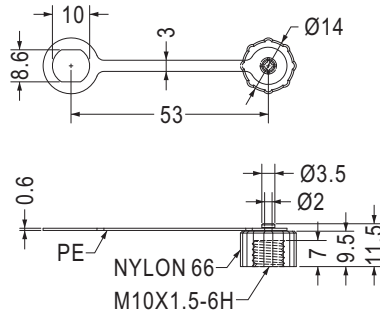

Part No.	Package
CAV-1	500

防水圈 WATERPROOF RING

用途：用於零件之連接，避免配件遺失。



- Material: EPDM
- Color: Black
- Unit: mm

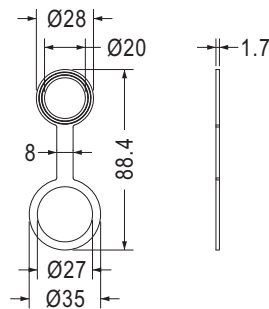

Part No.	Package
TF-568	100

線圈固定座 COIL HOLDER

用途：將鐵粉芯線圈固定於PC板上。

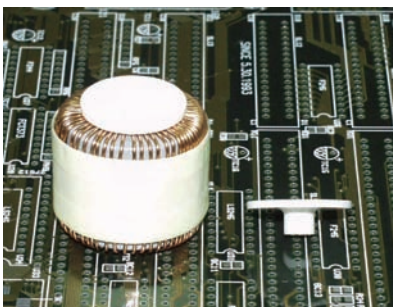

- Material: PBT (UL)
- Flame Class: 94V-0
- Color: Natural
- Unit: mm

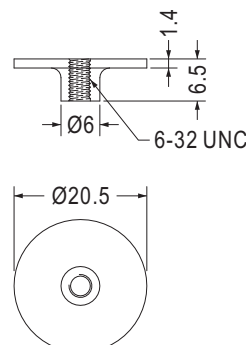

Part No.	Package
TRMH-20	500

風扇支架 FAN FRAME

用途：風扇固定支架。



- Material: TPE (UL)
- Flame Class: 94V-0
- Color: Black
- Unit: mm

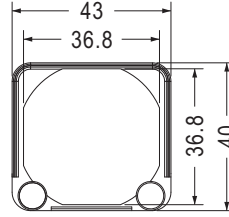

CHASSIS MOUNTING HOLE $\varnothing 4.1$
CHASSIS THICKNESS 1.0

FANS MOUNTING HOLE $\varnothing 3.5$
FANS THICKNESS: T

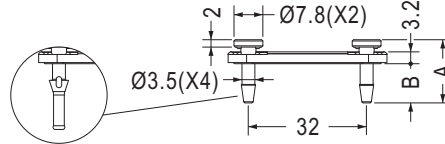

Part No.	A	B	T	Package
FANCA-1	17.1	10.6	6.0	500
★ FANCA-2	24.3	17.8	5.2	250

【 FANCA-2 】

風扇護蓋 REAR FAN PROTECTIVE COVER

用途：用於電腦風扇外框。



- Material: PBT (UL)
- Flame Class: 94V-0
- Color: Black
- Unit: mm

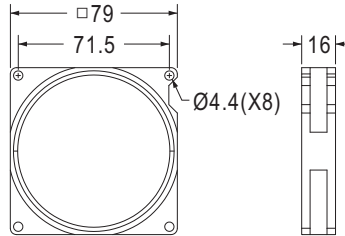

Part No.	Package
FANCS-3	500



- Material: PC (UL)
- Flame Class: 94V-2/94V-0
- Color: Black
- Unit: mm

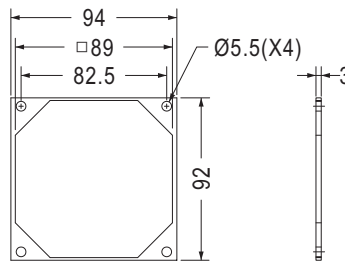

Part No.	Package
FANCV-1	500



- Material: PBT (UL)
- Flame Class: 94V-0
- Color: Black
- Unit: mm

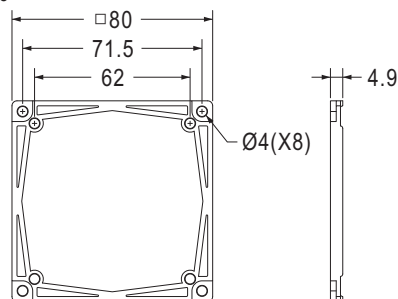

Part No.	Package
FANCV-3	500



- Material: ABS (UL)
- Flame Class: 94V-0
- Color: Black
- Unit: mm

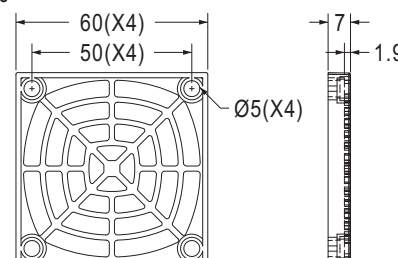

Part No.	Package
FANCV-9	100

風扇防塵座 ANTI-DUST FAN GUARD

用途：用於電腦或儀器風扇之防塵，避免灰塵進入機器內。

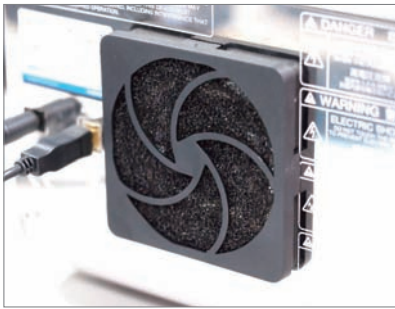

- Material: PC+ABS (UL)
- Flame Class: 94V-0
- Color: Black
- Unit: mm

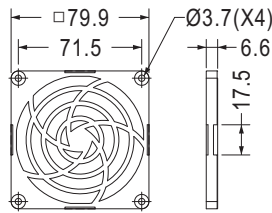

【 FANCV-5A 】

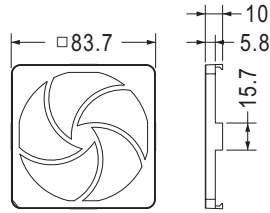

【 FANCV-5B 】

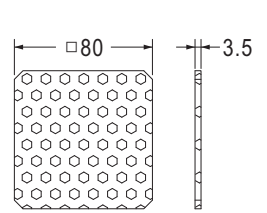

【 FANCV-5C 】

Part No.	Part No.	Package
FANCV-5	FANCV-5A	50
	FANCV-5B	
	FANCV-5C	
此為子母包:內容物包含右方零件		

風扇框護墊 FRAME PAD

用途：用於電腦風扇外框之防震，降低噪音。



- Material: Silicon Rubber
- Color: Black/Transparent
- Unit: mm

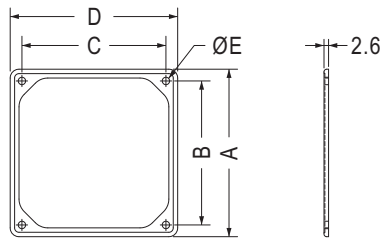

Part No.	A	B	C	D	E	Package
TF-143	94.8	81.5	81.5	94.8	4.2	50
TF-144	122.7	104.8	104.8	122.7	4.0	
TF-147	61.4	49.4	49.4	61.4	4.0	100

7



- Material: Silicon Rubber
- Color: Black
- Unit: mm

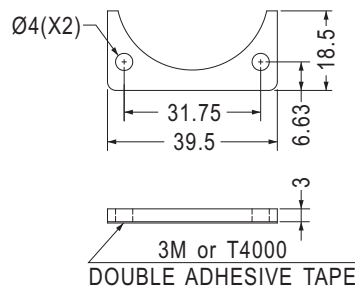

Part No.	Package
TF-018	200