

精心製作 · 為您打造 Precise Manufacture and customized only for you

提供客製化服務，具設計開模，並能依圖面開模生產

Provides customized service, experienced mold design and fabrication base on drawing



企業目標與政策實施 Corporate goals and Principles



高品質產品
High Quality
Products



專業的服務
Professional
Service



合理的價格
Reasonable
Price



準確的交期
Delivery On
Time

我們的優勢 Our strengths

- 擁有高階的工作母機，從模具的設計、製造，皆在廠內完成
Owns high-end working machines, in-house mold designs and fabrication.
- 可快速排除問題，縮短時間
Quick troubleshooting, minimizes lead time.
- 具有 OEM/ODM 能力，滿足客戶確切的規格及要求
Has OEM/ODM capabilities that are able to fulfill customer's requirements.
- 持續創新，每月會有50~70個新產品進入市場當中
Continue to innovate that has 50~70 new products every month.



設計開發
Development of design



專業製造
Professional manufacturer



多項合格認證
Multiple international certifications

越南廠 Vietnam Factory



■ 面積 Area

18,600 m²

■ 設立日期 Established

2023年8月 August 2023

■ 部門 Departments

業務部 Sales Dept.,
會計部 Accounting Dept.,
資材管理部 Procurement Dept.,
射出成型部 Injection Molding Dept.,
模具部 Mold Dept.,
品管部 Q.C. Dept.,
加工部 Process Dept.,
包裝部 Packaging Dept.,
倉庫 Warehouse.

聯絡資訊

Contact Information

Tel Number : +84-222-222-0598

Address : Lot CN5-1, Yen Phong Industrial Park Extension, Yen Trung Commune, Yen Phong Dist., Bac Ninh Prov., Vietnam

泰國廠 Thailand Factory



■ 面積 Area

6,200 m²

■ 設立日期 Established

2022年9月 September 2022

■ 部門 Departments

業務部 Sales Dept.,
會計部 Accounting Dept.,
資材管理部 Procurement Dept.,
射出成型部 Injection Molding Dept.,
模具部 Mold Dept.,
品管部 Q.C. Dept.,
加工部 Process Dept.,
包裝部 Packaging Dept.,
倉庫 Warehouse.

聯絡資訊

Contact Information

Tel Number : +66-2-323-0588

Address : 589 Moo 4, Phraeksa Sub-District, Mueang Samut Prakan District, Samut Prakan, 10280 Thailand

2024 EDITION

www.kangyang.com.tw

Kang Yang Hardware Enterprises Co., Ltd was founded in 1987 and has been manufacturing plastic components for 37 years. Kang Yang's headquarter is located in Taipei, and has 5 factories, one factory located in Taichung, two factories in China, one factory in Thailand, and one factory in Vietnam. Kang Yang has achieved many certifications such as ISO 9001, ISO 14001, QC 080000, IATF 16949 and etc.

Kang Yang Hardware Enterprises has been one of the world's leading and prestigious manufacturers specializing in plastic hardware and electronic components with over ten thousand types of products developed. Our engineering team is capable of developing new products within few weeks with state of the art machinery in our own in-house tool shops. With the OEM/ODM capability to help clients design products.

Kang Yang is a truly international corporation with premises in Taipei, United States, Europe and China. KY is proudly serving our clients in more than 100 countries and has increased its global presence in the IT, computer, electronics, automotive, medical and many other industries.

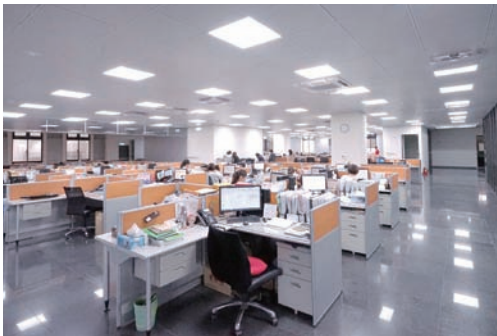
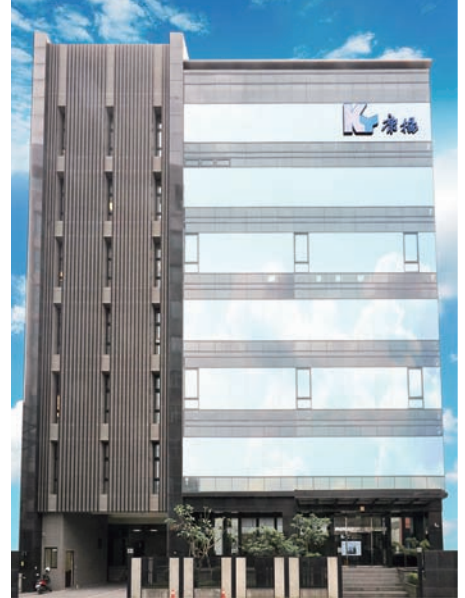

Milestones:

- 1987 Kang Yang Hardware Enterprises Co., Ltd. established in September 1987 in Taipei
- 1991 Taichung Factory established in Taichung
- 1994 Dong Guang Factory established in China
- 1999 Achieved ISO 9001 Certification
- 2003 Suzhou Factory established in China
- 2006 All factories are capable of mold design and manufacturer
- 2007 Achieved QC 080000 Certification
- 2008 Equipped 3D Prototype Mock up Sample Machine
- 2009 Achieved OHSAS 18001, SA 8000, and Sony Green Partner
- 2012 Suzhou Factory Phase 2 expansion completed
- 2013 Taipei Headquarters New Building completed
- 2014 All production lines are computerized
Implemented 2D Barcode Label System in ERP System
- 2017 Achieved IATF 16949 Certification
- 2020 Achieved ISO 45001 Certification
- 2022 Thailand Factory established in Thailand
- 2023 Vietnam Factory established in Vietnam

康揚企業股份有限公司 Kang Yang Hardware Enterprises Co.,Ltd.

■ 設立日期 Established

1987年9月 September, 1987

■ 電話 Tel Number

+886-2-2692-1498 (代表號)

■ 傳真 Fax Number

+886-2-2692-2498

■ 產品專利 Patents Acquired

擁有多國專利 Holding multi-national patents

■ UL QMMY2 工廠認證

UL E336444

■ UL 成品認證 UL Product

UL E127489, UL E217732, UL E530317

■ 認證 Certifications

ISO 9001, ISO 14001, QC 080000, IATF 16949



3D模型機 3D Printer



影像測量儀 Image Measuring System

台北總公司 Taipei Headquarters

■ 地址 Address

新北市汐止區環河街187號

No. 187, Huanhe St., Xizhi Dist., New Taipei City

■ 面積 Area

9,570 m²

■ 部門 Departments

國內業務部 Local Sales Dept.,

國外業務部 Export Sales Dept.,

會計部 Accounting Dept.,

資財管理部 Procurement Dept.,

人事部 HR Dept.,

研發部 R & D Dept.,

工程部 Engineering Dept.,

品保部 Q.C. Dept.,

倉庫 Warehouse.

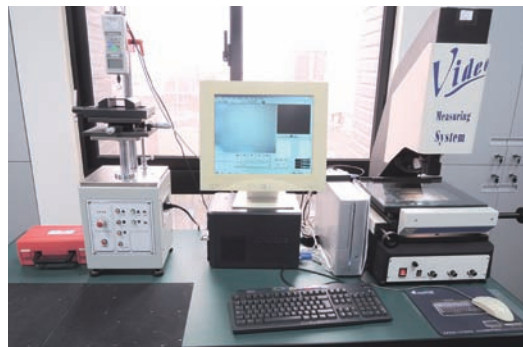

推拉力計，二次元影像式量測儀
Force Gauge, Video Measuring System

儀器設備：電腦繪圖機、日製投影機、影像式精密測繪儀、硬度計、AC/DC高壓絕緣測試機、拉力計、電子式卡尺、各種牙規、柱規、塊規、螺絲扭力計、點膠機、扭力測試機……

Equipment：Computer plotters, Overhead projectors, Video measuring system, Durometer, AC/DC High-Voltage Insulator Tester, Force Gauge, Digital Calipers, Pin gauge, Gauge block sets, Torsion Tester, Glue Dispensing Robot, Force Gauge, Prototype Sample Making Machine, etc



堀場 - X射線螢光分析儀(XRF)
Horiba - X-Ray Fluorescence Analyzer



小型恆濕恆溫試驗機
Bench-top Type Temperature & Humidity Chamber



台中工廠 Taichung Factory

■ 面積 Area

12,850 m²

■ UL QMMY2 工廠認證

UL E336444

■ 認證 Certifications

ISO 9001, ISO 14001, QC 080000, IATF 16949

■ 部門 Departments

射出成型部 Injection Molding Dept.,

模具部 Mold Dept.,

品管部 Q.C Dept.,

加工部 Processing Dept.,

包裝部 Packaging Dept.,

倉庫 Warehouse.



發那科 - CNC機
Fanuc - CNC Machine



東京精密 - 三次元測量儀
Tokyo Seimitsu - 3D Coordinate Measuring Machine

機器設備：射出成型機、機械手臂、自動供料機、CNC機、CNC放電加工機、模溫機、裁切機、除濕乾燥機、攪拌機、粉碎機

Equipment：Injection Molding Machine, Robotic Arm, Automatic Material Feeder, CNC Machine, CNC EDM Machine, Mold Temperature Controller, Cutting Machine, Dehumidifying Dryer, Material Mixer, Plastic Shedder Machine.



蘇比克 - 放電加工機
Sodick - EDM Machine



蘇比克 - 線切割機
Sodick - Wire EDM Machine



夏米爾 - 放電機
Charmilles - EDM Machine



大型進口射出機
Large Injection Machine



射出車間
Injection Work Shop



射出車間
Injection Work Shop



射出車間
Injection Work Shop



射出車間
Injection Work Shop



東莞廠 Dong Guan Factory

■ 地址 Address

廣東省東莞市長安鎮上角社區紅棉路2號
No. 2, Hong Mian Road., Shang Jiao
Management District, Chang An Town,
Dong Guan City, Guang Dong Province

■ 電話 Tel Number

+86-769-85305187

■ 傳真 Fax Number

+86-769-85411815

■ 面積 Area

22,800 m²

■ 設立日期 Established

1994年5月 May, 1994

■ UL QMMY2 工廠認證

UL E336444

■ 認證 Certifications

ISO 9001, ISO 14001, ISO 45001,
QC 080000, IATF 16949

■ 部門 Departments

業務部 Sales Dept.,
會計部 Accounting Dept.,
資材管理部 Procurement Dept.,
射出成型部 Injection Molding Dept.,
模具部 Mold Dept.,
品管部 Q.C. Dept.,
加工部 Process Dept.,
包裝部 Packaging Dept.,
倉庫 Warehouse.

機器設備：射出成型機、機械手臂、自動供料機、CNC機、CNC放電加工機、模溫機、裁切機、
除濕乾燥機、攪拌機、粉碎機

Equipment：Injection Molding Machine, Robotic Arm, Automatic Material Feeder, CNC Machine,
CNC EDM Machine, Mold Temperature Controller, Cutting Machine, Dehumidifying
Dryer, Material Mixer, Plastic Shedder Machine



夏米爾 - 放電機
Charmilles - EDM Machine



米克朗 - CNC加工機
Mikron - CNC Machine



射出車間
Injection Work Shop



射出車間
Injection Work Shop



射出車間
Injection Work Shop



射出車間
Injection Work Shop



牧野 - 放電加工機
Makino - EDM Machine



發那科 - CNC加工機
Fanuc - CNC Machine

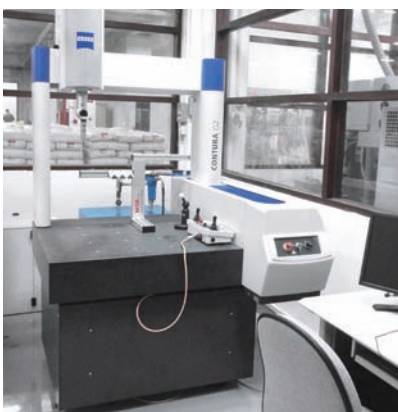

蔡司 - 三次元測量儀
Carl Zeiss - 3D Coordinate
Measuring Machine



蘇比克 - 線切割機
Sodick - Wire EDM Machine



蘇州廠 Suzhou Factory

■ 地址 Address

江蘇省蘇州市吳江區松陵鎮花港路877號
No. 877, Hua Gang Rd., Song
Ling Town, Suzhou City, Wujiang
Dist, Jiang Su Province

■ 電話 Tel Number

+86-512-80670100

■ 傳真 Fax Number

+86-512-63434598~9

■ 面積 Area

39,805 m²

■ 設立日期 Established

2003年1月 January, 2003

■ UL QMMY2 工廠認證

UL E336444

■ 認證 Certifications

ISO 9001, ISO 14001, ISO 45001,
QC 080000, IATF 16949

■ 部門 Departments

業務部 Sales Dept.,
會計部 Accounting Dept.,
資材管理部 Procurement Dept.,
射出成型部 Injection Molding Dept.,
模具部 Mold Dept.,
品管部 Q.C. Dept.,
加工部 Process Dept.,
包裝部 Packaging Dept.,
倉庫 Warehouse.

機器設備：射出成型機、機械手臂、自動供料機、CNC機、CNC放電加工機、模溫機、裁切機、
除濕乾燥機、攪拌機、粉碎機、沖床40噸

Equipment：Injection Molding Machine, Robotic Arm, Automatic Material Feeder, CNC Machine,
CNC EDM Machine, Mold Temperature Controller, Cutting Machine, Dehumidifying
Dryer, Material Mixer, Plastic Shedder Machine, 40T Punch Press Machine



夏米爾 - 放電機
Charmilles - EDM Machine



米克朗 - CNC加工機
Mikron - CNC Machine



潔淨車間
Work Shop In Clean Surrounding



射出車間
Injection Work Shop



射出車間
Injection Work Shop



射出車間
Injection Work Shop



蘇比克 - 放電加工機
Sodick - EDM Machine



蘇比克 - 線切割機
Sodick - Wire EDM Machine



牧野 - 放電加工機
Makino - EDM Machine

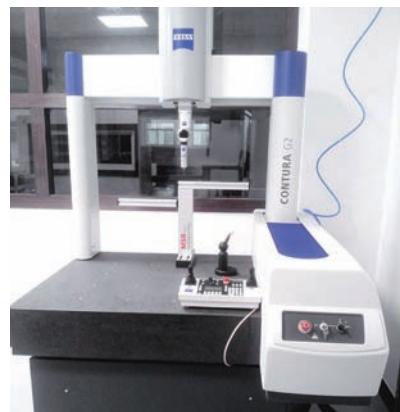

蔡司 - 三次元量測儀
Carl Zeiss - 3D Coordinate
Measuring Machine

- ◎ 產品尺寸、規格以本公司製作之承認書為主，目錄為輔。
- ◎ 因手感不同，建議裝配孔及裝配件尺寸，僅供參考。
- ◎ 本目錄之包裝數量僅供參考，實際數量以本公司之產品包裝標示為主。
- ◎ 標★與 **NEW**，則為新產品。
- ◎ 如要開發新產品，歡迎來電詢問。
- ◎ 2023.12.1編輯・發行。
- ◎ Specifications are subject to change without prior notice.
- ◎ Suggested mounting holes and assembly parts are for reference only.
- ◎ Catalogue standard package Q'ty are served as reference only.
- ◎ Items marked in ★ and **NEW** are new products.
- ◎ Custom-made and OEM services are also available.
- ◎ Issued on 2023.12.1

康揚公司環保理念與政策實施

我們在環保減廢的層面上，做到了辦公室無紙化，部門間的訊息傳遞使用電子傳輸及閱讀，且工廠端製程管控已導入電腦化的數據登錄，可大幅降低紙張用量。

在節能減碳的層面上，做到了整棟大樓採用LED照明以及感測器開關，暫時無人使用的區域可以感應電源開與關，相較傳統燈泡、燈管..等節省了40%~50%的電能耗用。另外，主要的製造設備：塑膠射出成型機逐步更新使用電動機，相較於傳統的油壓機更可節能50%以上，同時並倡導全體員工隨手關燈節水，善盡環保節能愛地球的企業責任。

在控制與降低環保衝擊的層面上，我們選用了符合EU RoHS及ECHA REACH法規，並遵循各國際大廠環保材料規範及國際衝突礦產錫(Sn)、鉭(Ta)、鎢(W)、金(Au)、鈷(Co)不使用法規，持續並依據ISO 14001系統的管理要求，確保環保法令及法規的更新與管控，內部先期導入X射線螢光分析儀檢測管控，外部主動要求原料及合格供應商提供環境管理物質的檢測報告，以監測、監控產品實現的過程有效運作。

Kang Yang's Environmental Policy and Practice:

Kang Yang has been practicing environmental policies in perspective of conservation, energy saving, and controlling and reducing environment impact.

In conservation perspective, we are paperless office that communicates information by e-documentations between departments. A great portion of paper has been reduced by using computerized data input in production control in factories.

In energy saving perspective, the Kang Yang building is equipped with LED and light sensors that save electricity in the area that is temporarily not in use. This saved 40%~50% electricity consumption comparing with traditional lightning. Furthermore, our manufacturing machines use electric generators instead of traditional hydraulic cylinder which save 50% energy. In Addition, we advocate all Kang Yang employees to turn off light when not in use and save water to fulfill our corporate social responsibility.

In controlling and reducing environmental impact perspective, all of Kang Yang products are EU RoHS, ECHA REACH compliant and we use materials that are compliant to EU RoHS, ECHA REACH and follow International Companies' Regulations and Conflict Minerals (Tin, Tantalum, Tungsten, and Gold) Non-Using Law. Based on QC 08000 and ISO14001's requirement, we ensure all environmental law and regulation are updated and controlled in company. From the internal perspective, we use many different testing instruments to ensure our products are EU RoHS, ECHA REACH compliant. From the external perspective, we request our material suppliers to provide environmental test reports in order to ensure their production process are environmental friendly as well.

Spacer Support, Round Spacer, Threaded Spacer, Pillar Support, Conductive Spacer Support

PC板間隔柱、圓體間隔柱、塑膠銅柱、導光板間隔柱、導電PC板間隔柱

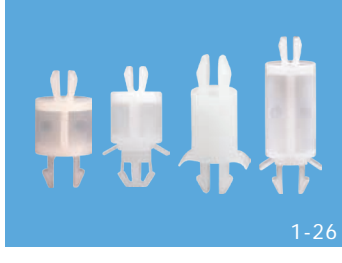
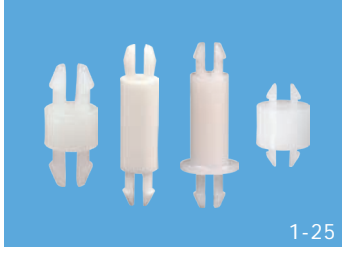
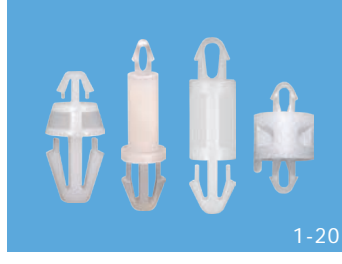
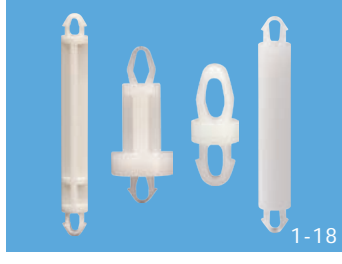
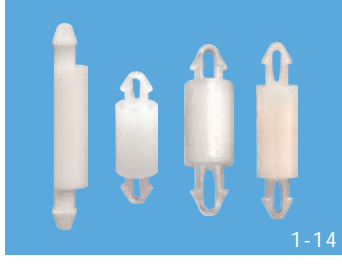
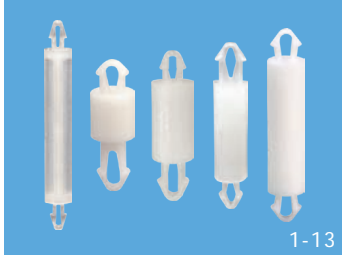
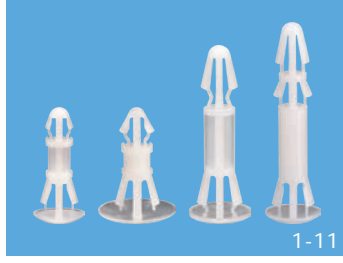
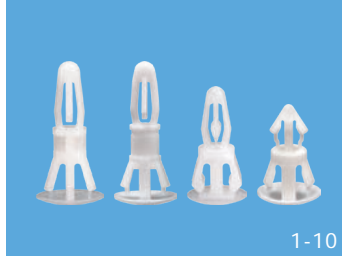
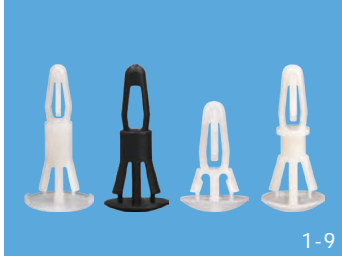
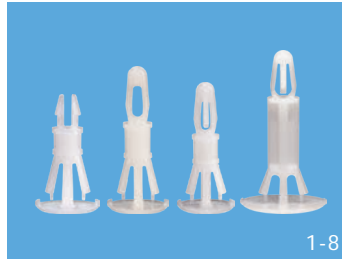
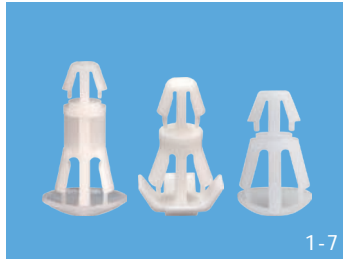
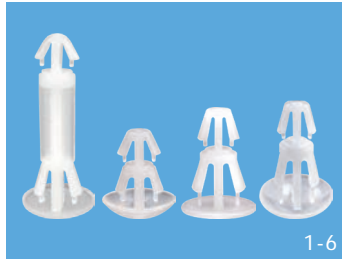
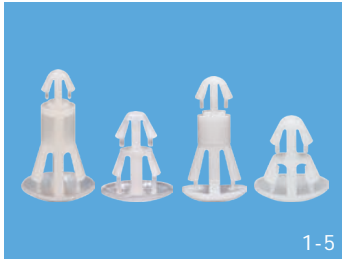
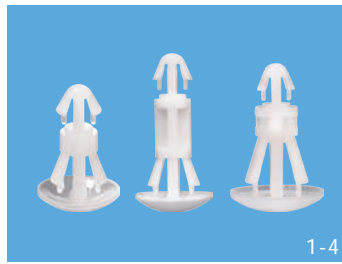
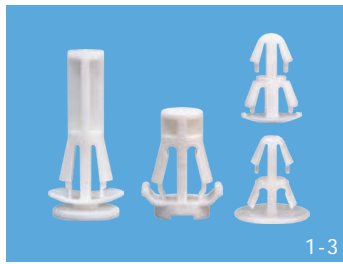
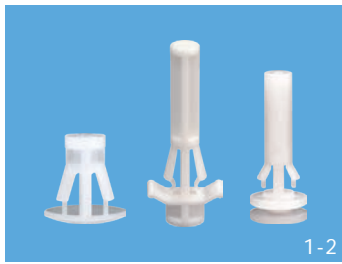
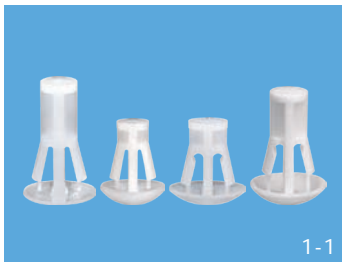

Spacer Support, Round Spacer, Threaded Spacer, Pillar Support, Conductive Spacer Support

PC板間隔柱、圓體間隔柱、塑膠銅柱、導光板間隔柱、導電PC板間隔柱

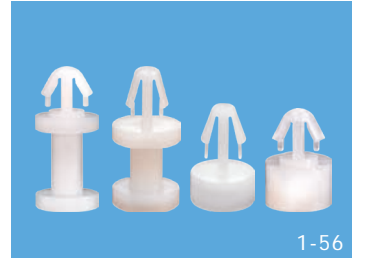
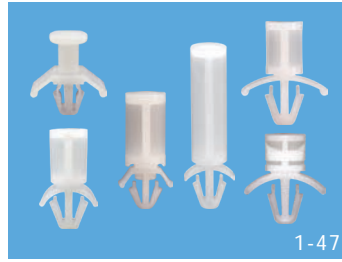
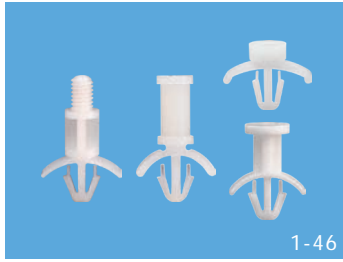
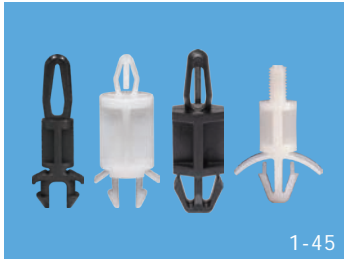
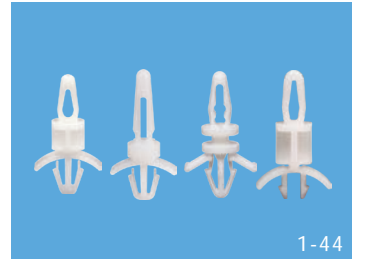
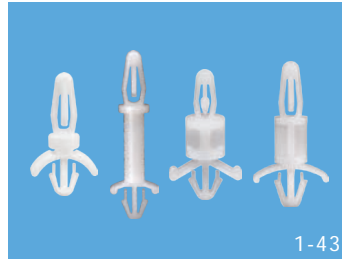
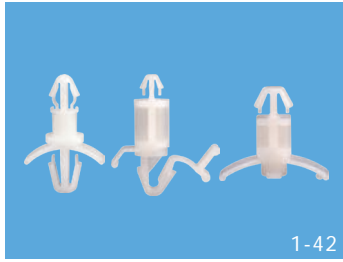
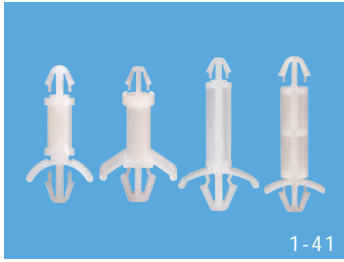
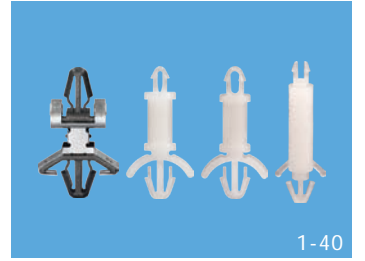
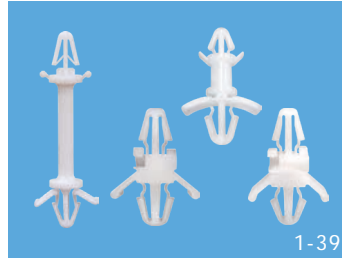
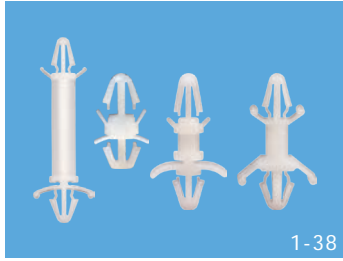
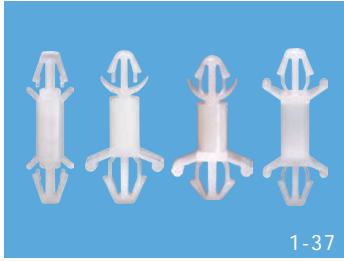
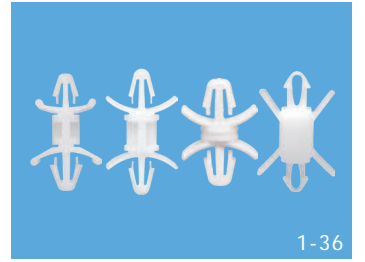
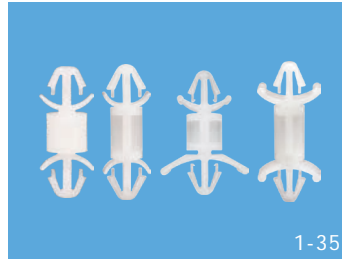
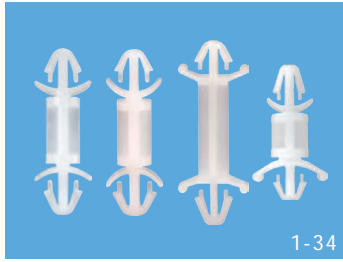
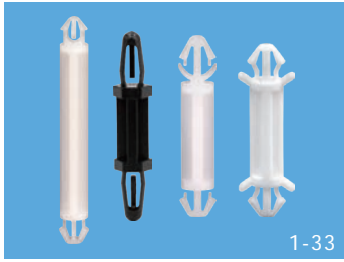
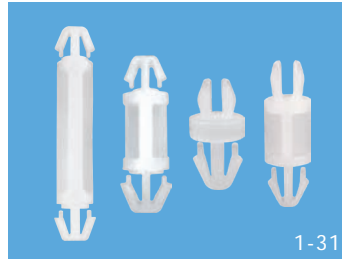
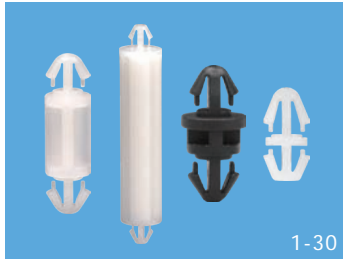
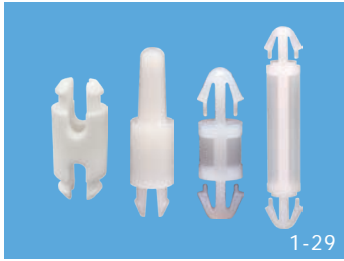

Spacer Support, Round Spacer, Threaded Spacer, Pillar Support, Conductive Spacer Support

PC板間隔柱、圓體間隔柱、塑膠銅柱、導光板間隔柱、導電PC板間隔柱



1-57



1-58



1-59



1-60

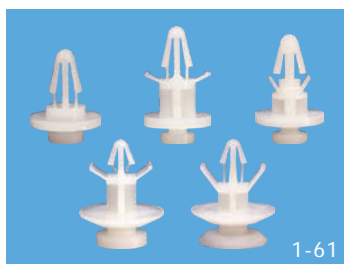

1-61



1-62



1-63



1-64



1-65



1-66



1-67

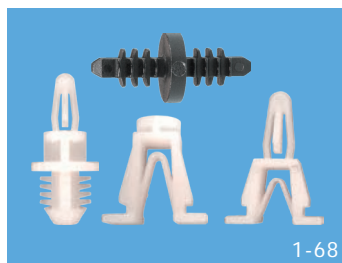

1-68



1-69



1-70



1-71



1-72



1-73



1-74



1-75

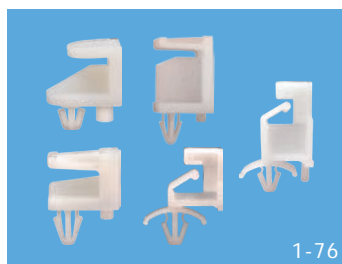

1-76



1-77

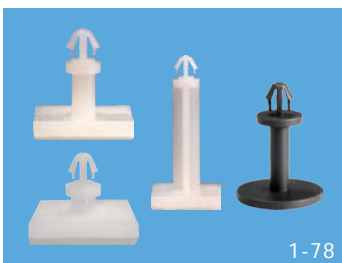

1-78



1-79



1-80

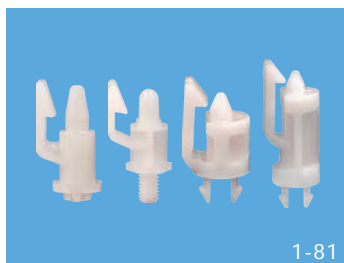

1-81



1-82



1-83



1-84

Spacer Support, Round Spacer, Threaded Spacer, Pillar Support, Conductive Spacer Support

PC板間隔柱、圓體間隔柱、塑膠銅柱、導光板間隔柱、導電PC板間隔柱

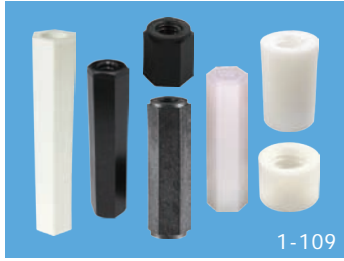
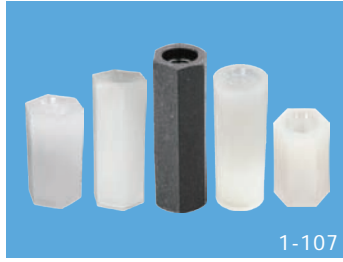
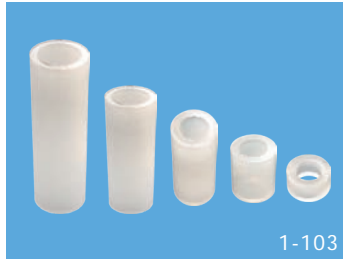
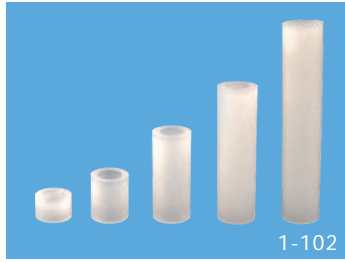
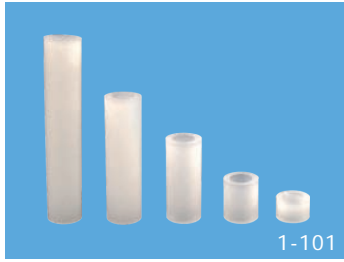
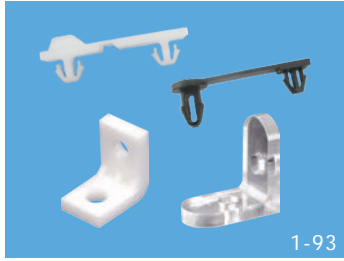
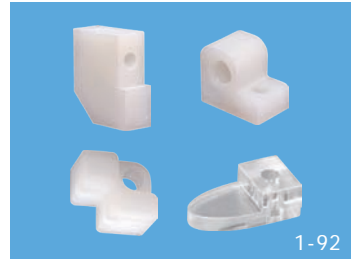
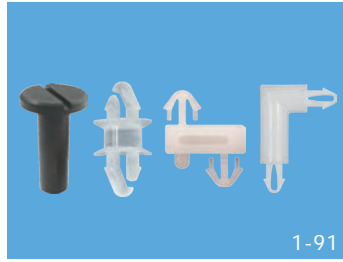
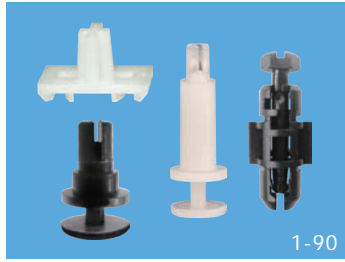
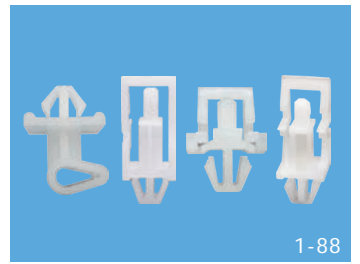
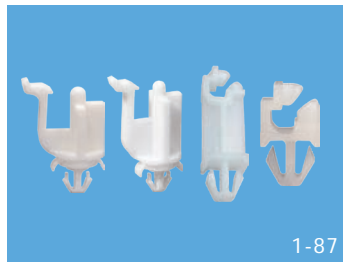
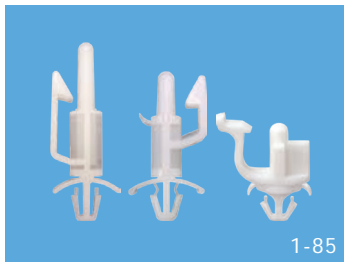

Spacer Support, Round Spacer, Threaded Spacer, Pillar Support, Conductive Spacer Support

PC板間隔柱、圓體間隔柱、塑膠銅柱、導光板間隔柱、導電PC板間隔柱

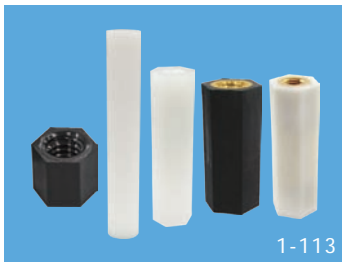

1-113



1-114



1-115



1-116



1-117

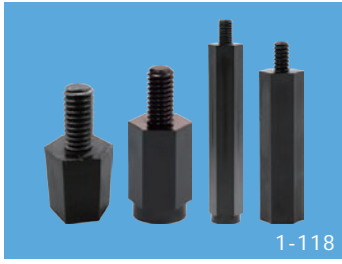

1-118



1-119

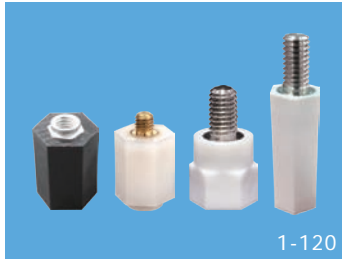

1-120



1-121



1-122



1-123



1-124



1-125

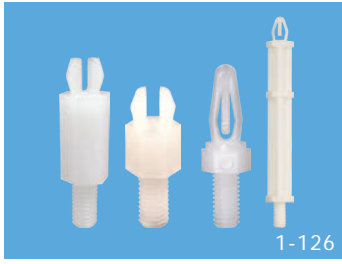

1-126



1-127

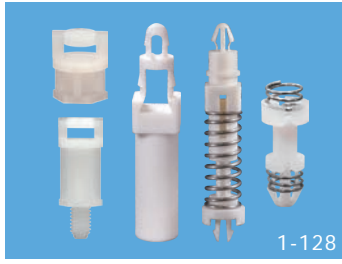

1-128

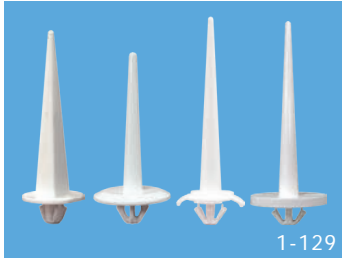

1-129



1-130



1-131

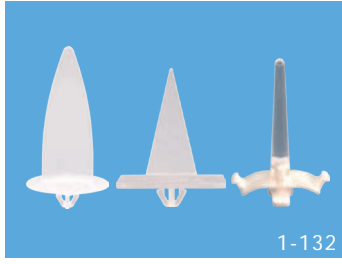

1-132

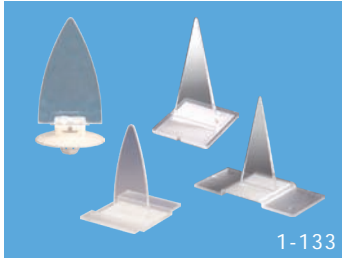

1-133

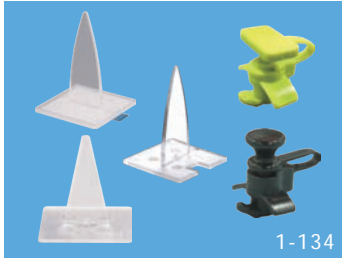

1-134



1-135



1-136



1-137



1-138



1-139



1-140

1

Spacer Support, Round Spacer, Threaded Spacer, Pillar Support, Conductive Spacer Support

PC板間隔柱、圓體間隔柱、塑膠銅柱、導光板間隔柱、導電PC板間隔柱

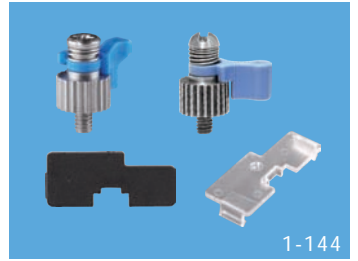
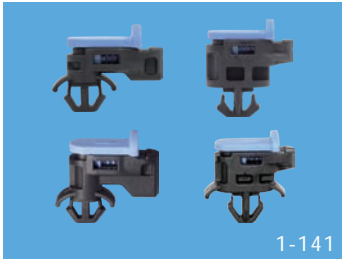

LED Spacer Supports, LED Holders & Covers, LED Lens Caps, Light Pipes, Light Pipe Masks, Optical Fiber Mounts, LED Covers & Lampshades

LED間隔柱、LED座/蓋/座套、LED導光蓋、LED導光柱、LED遮光罩、光纖座、燈罩

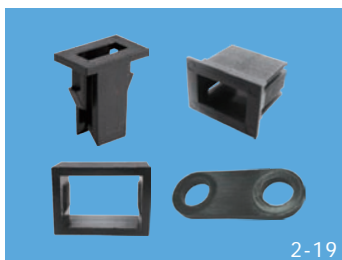
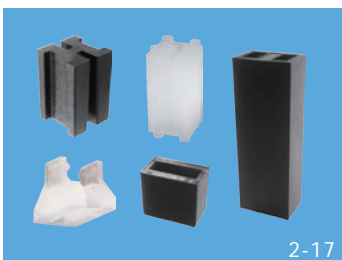
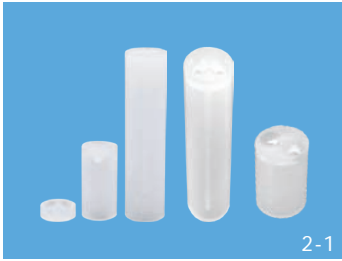

LED Spacer Supports, LED Holders & Covers, LED Lens Caps, Light Pipes, Light Pipe Masks, Optical Fiber Mounts, LED Covers & Lampshades

LED間隔柱、LED座/蓋/座套、LED導光蓋、LED導光柱、LED遮光罩、光纖座、燈罩

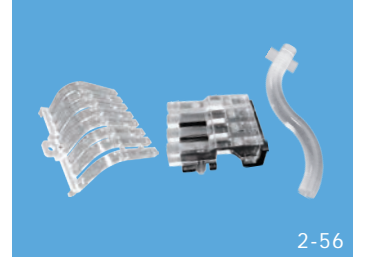
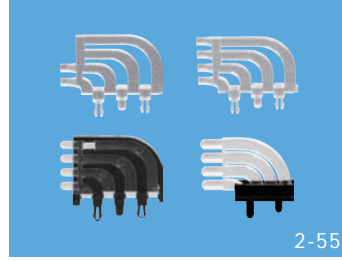
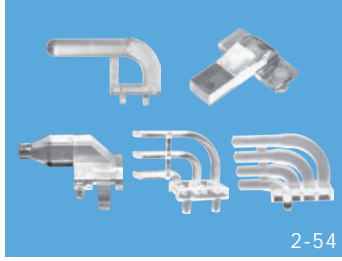
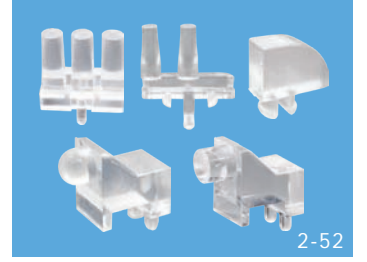
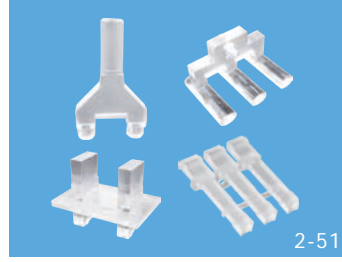
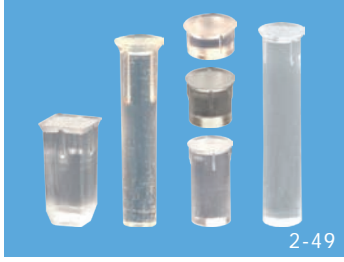
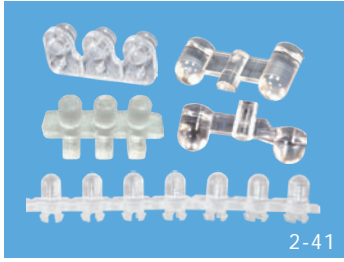
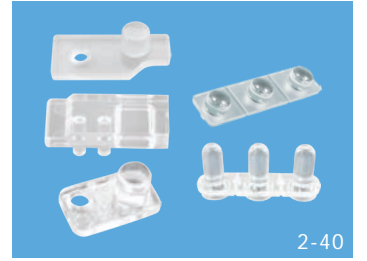
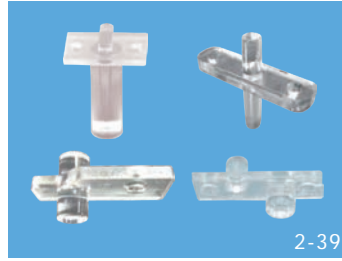
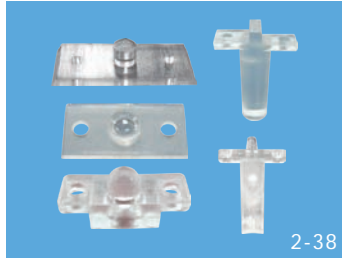
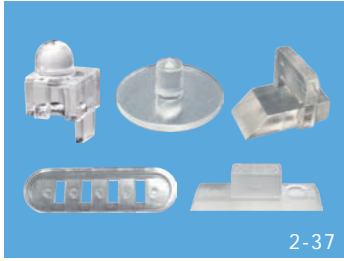
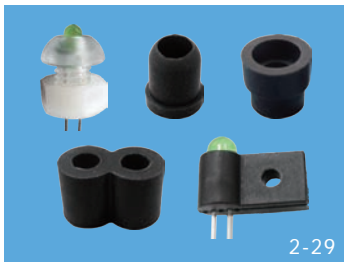

LED Spacer Supports, LED Holders & Covers, LED Lens Caps, Light Pipes, Light Pipe Masks, Optical Fiber Mounts, LED Covers & Lampshades

LED間隔柱、LED座/蓋/座套、LED導光蓋、LED導光柱、LED遮光罩、光纖座、燈罩

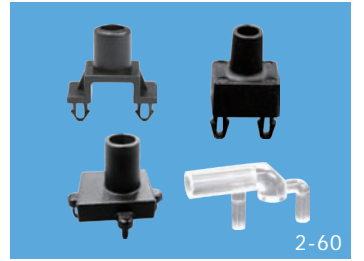
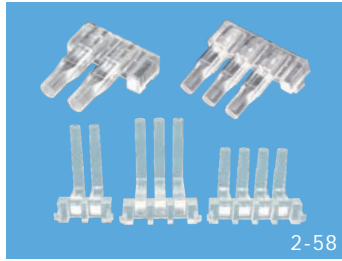
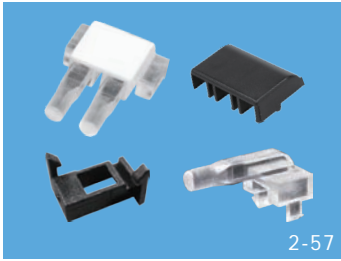

3

90° LED Holder

90° LED 燈座

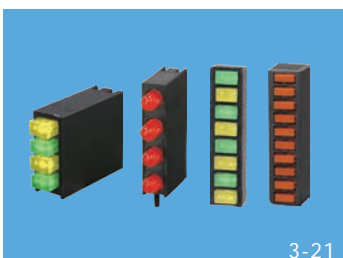
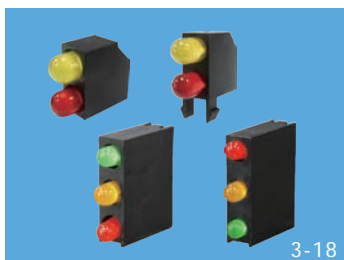
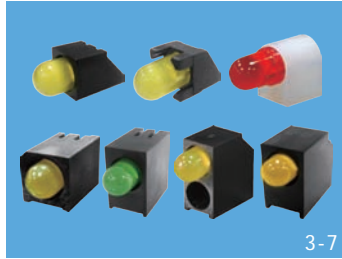
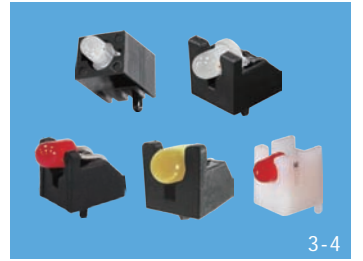

Cable Clamps & Clips, Wire Saddles, Wire Mounts/holders, Twist Locks, Cable Tie Mounts, Cable Carriers, Power Cord/Socket Fasteners, Other Mounts & Fasteners

排線固定板/固定扣/線夾、電線固定座、隔離束線座、扭式固定座/環、束線帶固定座、電源線/插座固定座、軌道式線扣組、其它固定產品



4

Cable Clamps & Clips, Wire Saddles, Wire Mounts/ Holders, Twist Locks, Cable Tie Mounts, Cable Carriers, Power Cord/Socket Fasteners, Other Mounts & Fasteners

排線固定板/固定扣/線夾、電線固定座、隔離束線座、扭式固定座/環、束線帶固定座、電源線/插座固定座、軌道式線扣組、其它固定產品

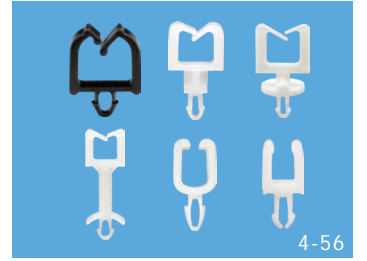
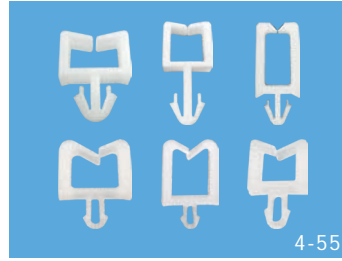
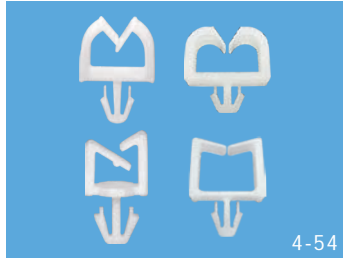
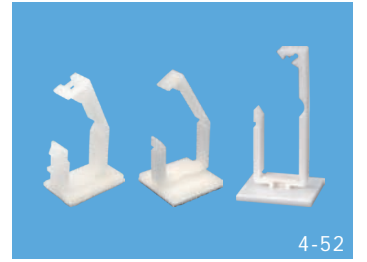
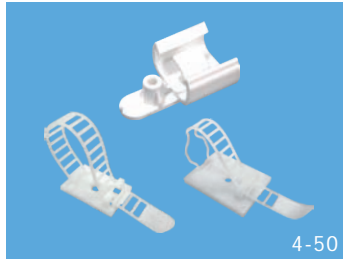
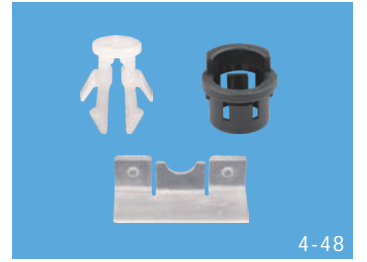
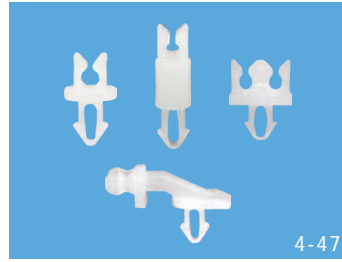
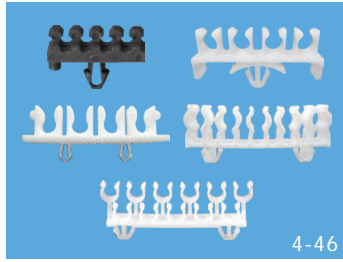
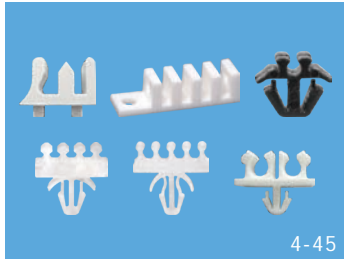
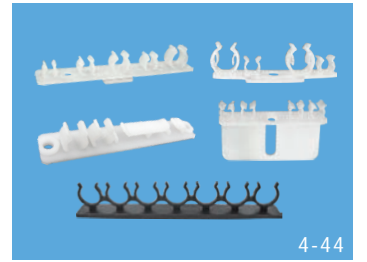
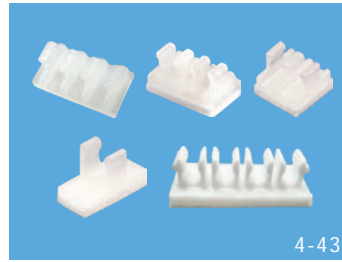
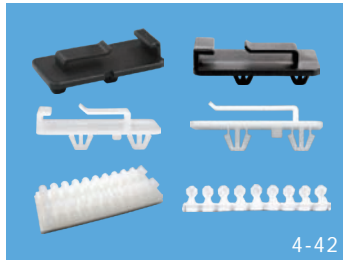
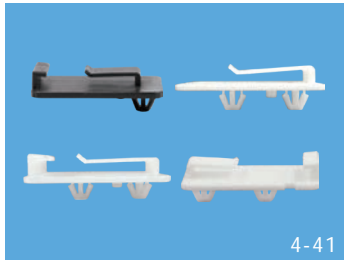
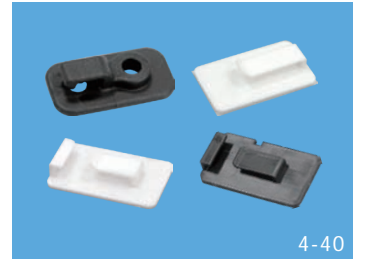
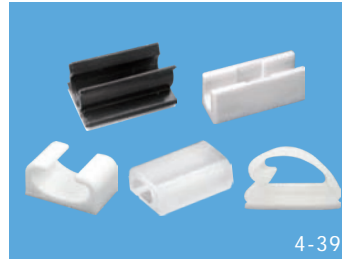
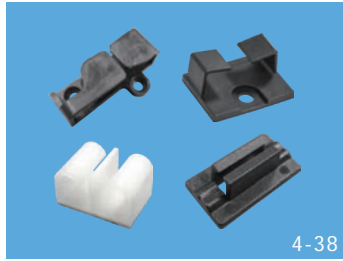
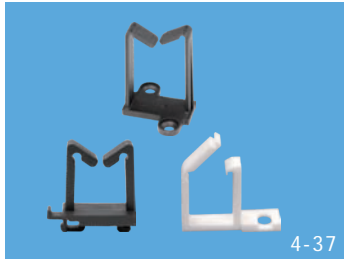
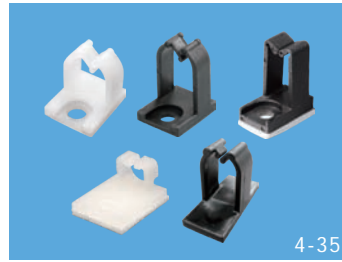
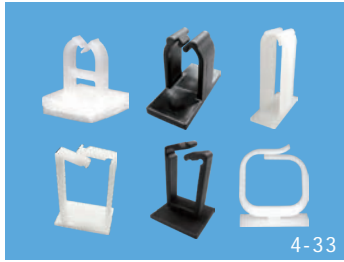
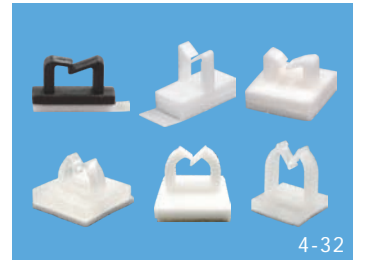
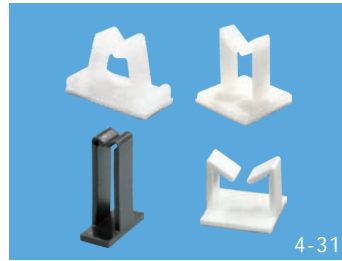
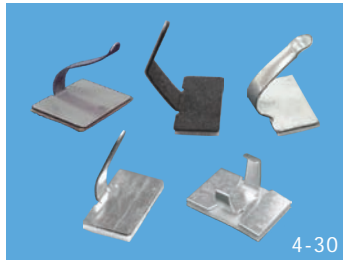
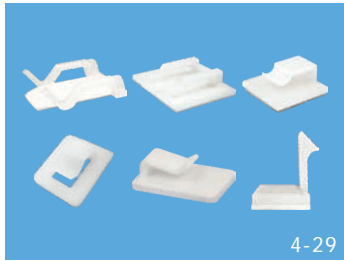

Cable Clamps & Clips, Wire Saddles, Wire Mounts/holders, Twist Locks, Cable Tie Mounts, Cable Carriers, Power Cord/Socket Fasteners, Other Mounts & Fasteners

排線固定板/固定扣/線夾、電線固定座、隔離束線座、扭式固定座/環、束線帶固定座、電源線/插座固定座、軌道式線扣組、其它固定產品



4

Cable Clamps & Clips, Wire Saddles, Wire Mounts/ Holders, Twist Locks, Cable Tie Mounts, Cable Carriers, Power Cord/Socket Fasteners, Other Mounts & Fasteners

排線固定板/固定扣/線夾、電線固定座、隔離束線座、扭式固定座/環、束線帶固定座、電源線/插座固定座、軌道式線扣組、其它固定產品

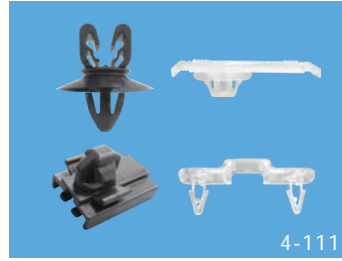
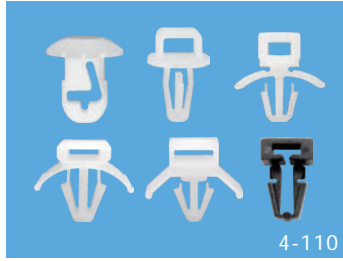
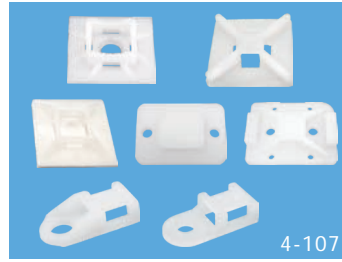
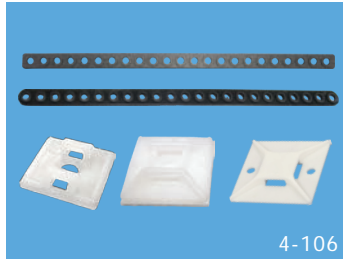
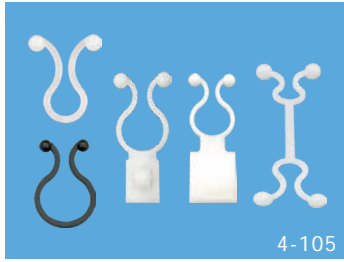
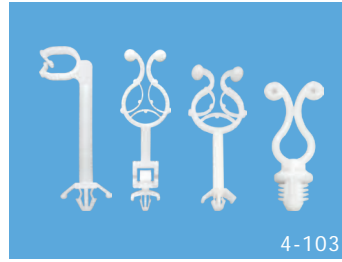
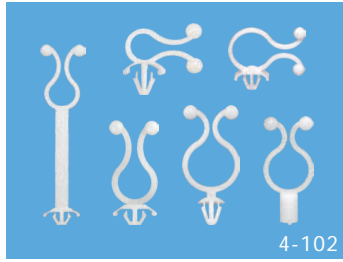
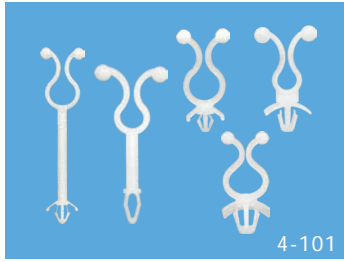
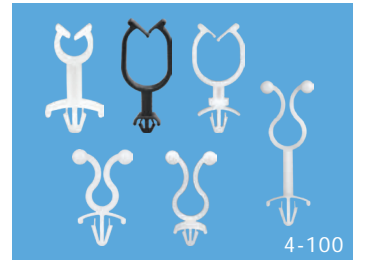
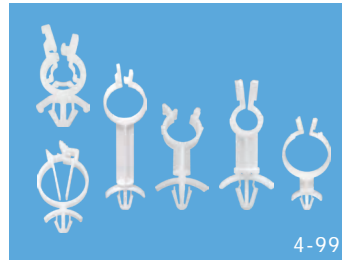
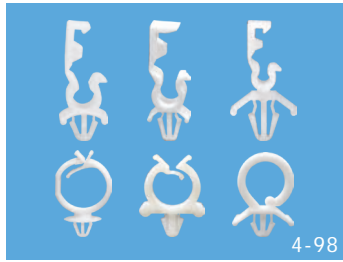
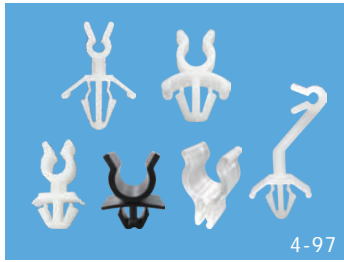
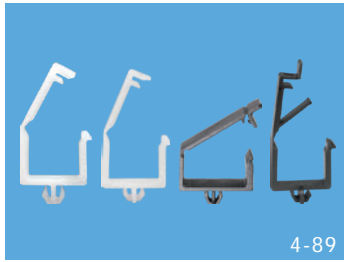
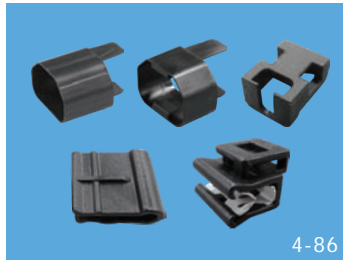

Cable Clamps & Clips, Wire Saddles, Wire Mounts/holders, Twist Locks, Cable Tie Mounts, Cable Carriers, Power Cord/Socket Fasteners, Other Mounts & Fasteners

排線固定板/固定扣/線夾、電線固定座、隔離束線座、扭式固定座/環、束線帶固定座、電源線/插座固定座、軌道式線扣組、其它固定產品



Snap Bushing, Grommet, Hole Plug, Strain Relief Bushing, Cable Tie, PVC Tube, Heat Shrink Tubing, Silicon Fiberglass Sleeve, Handle, Box Handle, Moveable Bushing, Wire Label

護線環、橡膠線環、扣式塞頭、電源線扣、電線束線帶、PVC 套管、熱縮套管、織布管、把手、外箱扣、活用護線套、黏貼標誌貼紙



5

Snap Bushing, Grommet, Hole Plug, Strain Relief Bushing, Cable Tie, PVC Tube, Heat Shrink Tubing, Silicon Fiberglass Sleeveing, Handle, Box Handle, Moveable Bushing, Wire Label

護線環、橡膠線環、扣式塞頭、電源線扣、電線束線帶、PVC 套管、熱縮套管、織布管、把手、外箱扣、活用護線套、黏貼標誌貼紙

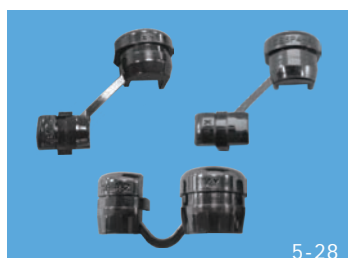
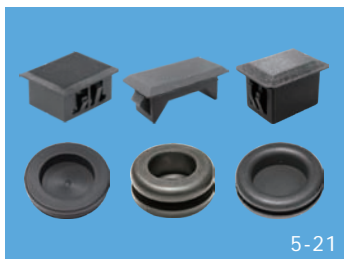
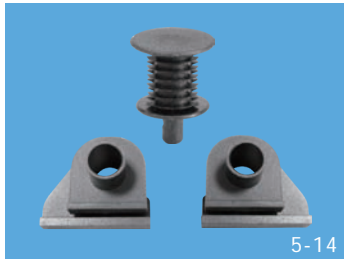
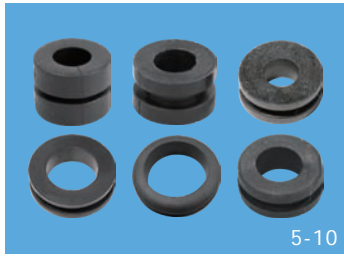
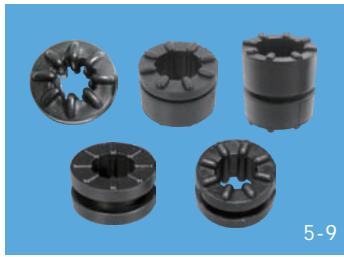
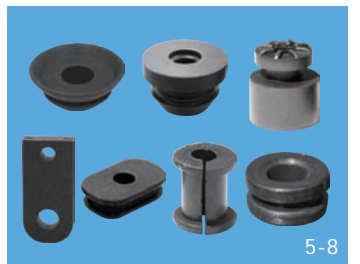
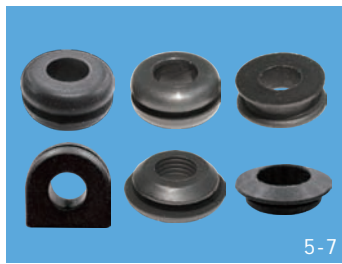
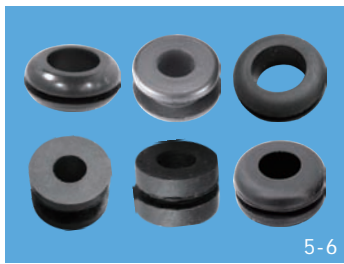
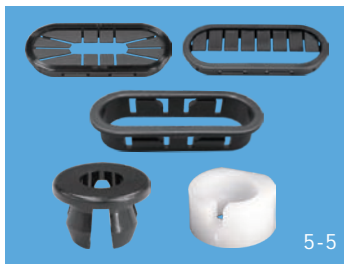

Snap Bushing, Grommet, Hole Plug, Strain Relief Bushing, Cable Tie, PVC Tube, Heat Shrink Tubing, Silicon Fiberglass Sleeve, Handle, Box Handle, Moveable Bushing, Wire Label

護線環、橡膠線環、扣式塞頭、電源線扣、電線束線帶、PVC 套管、熱縮套管、織布管、把手、外箱扣、活用護線套、黏貼標誌貼紙

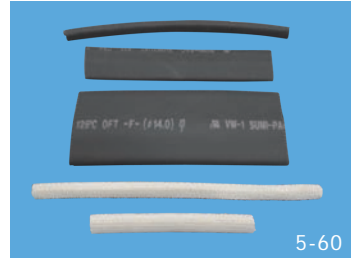
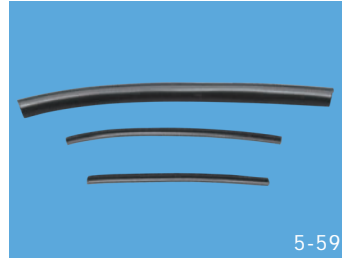
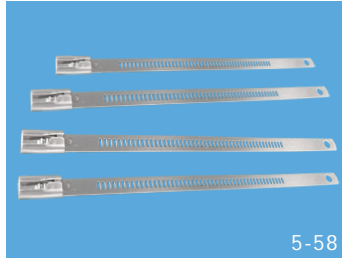
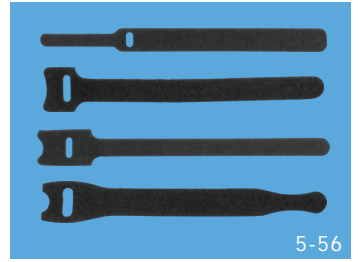
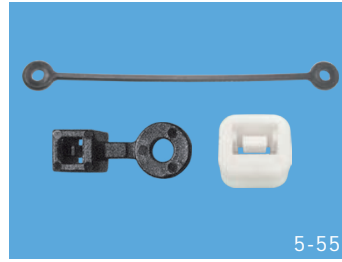
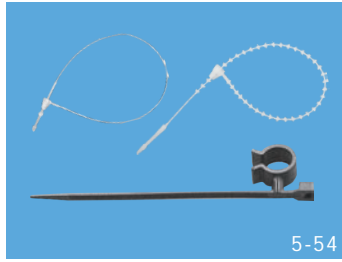
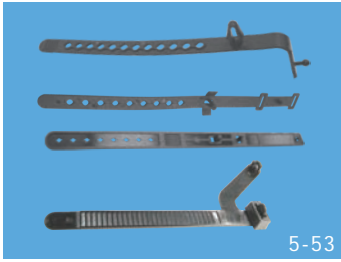
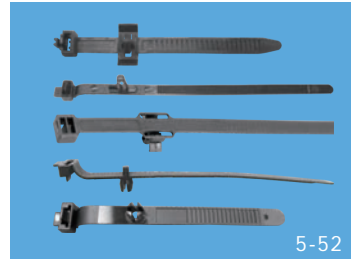
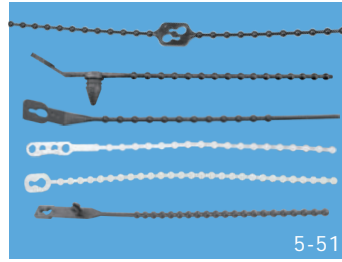
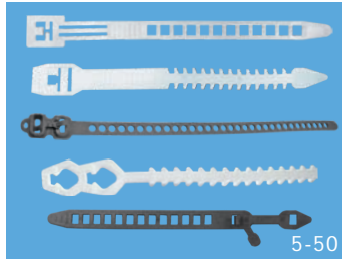
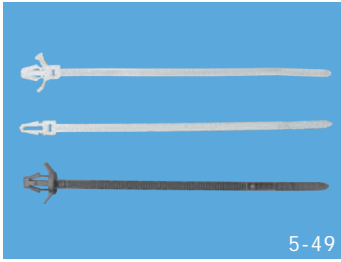
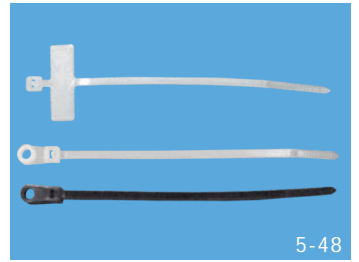
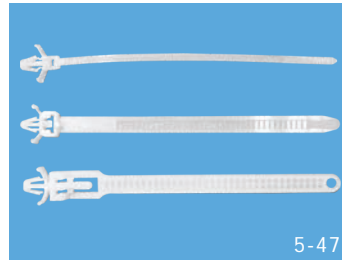
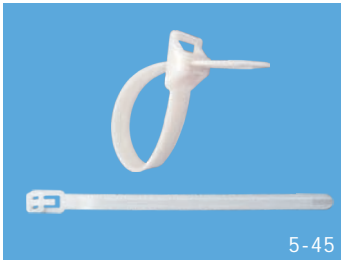
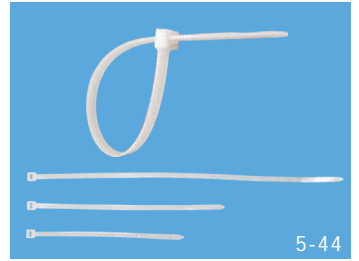
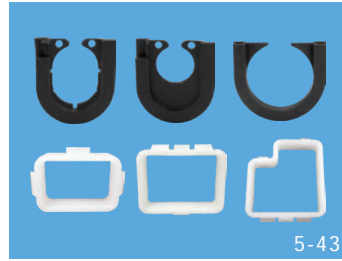
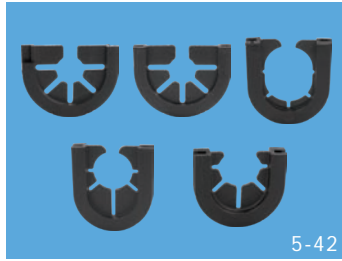
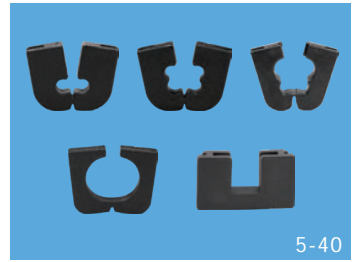
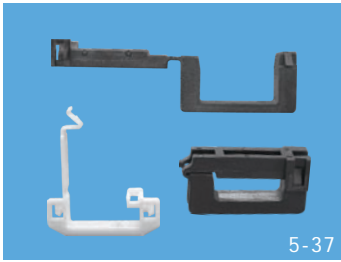
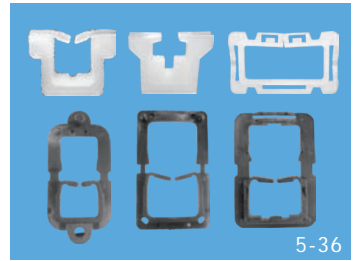
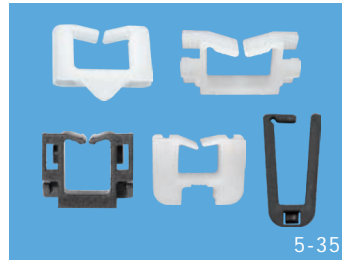

5

Snap Bushing, Grommet, Hole Plug, Strain Relief Bushing, Cable Tie, PVC Tube, Heat Shrink Tubing, Silicon Fiberglass Sleeveing, Handle, Box Handle, Moveable Bushing, Wire Label

護線環、橡膠線環、扣式塞頭、電源線扣、電線束線帶、PVC 套管、熱縮套管、織布管、把手、外箱扣、活用護線套、黏貼標誌貼紙



5-61

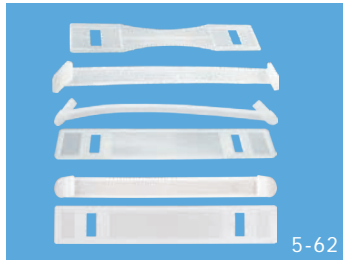

5-62

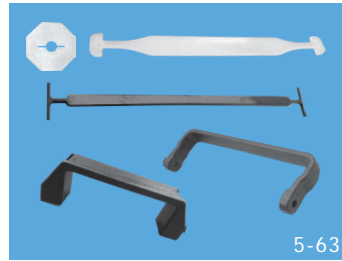

5-63



5-64



5-65



5-66



5-67



5-68



5-69



5-70



5-71

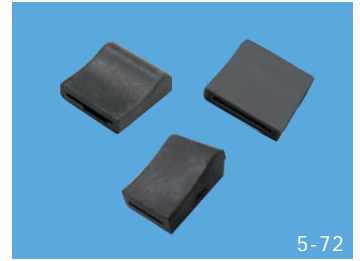

5-72

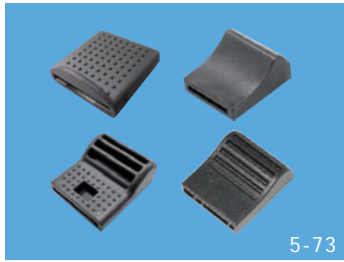

5-73

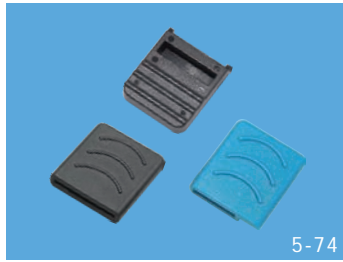

5-74

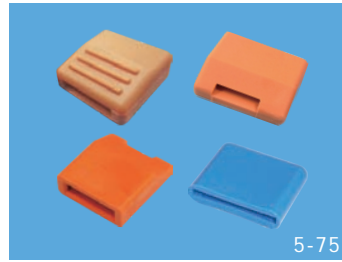

5-75

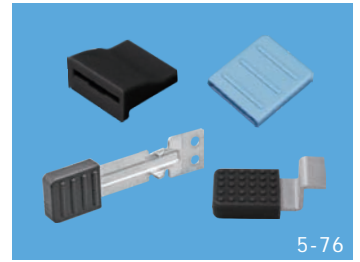

5-76

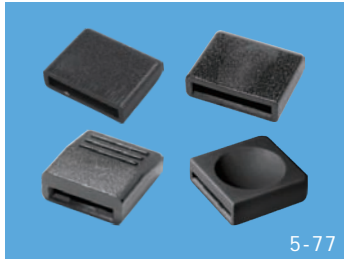

5-77



5-78



5-79

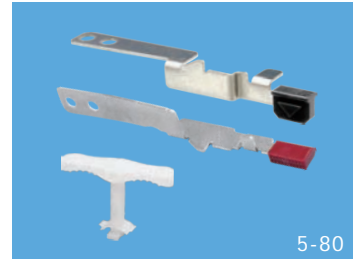

5-80

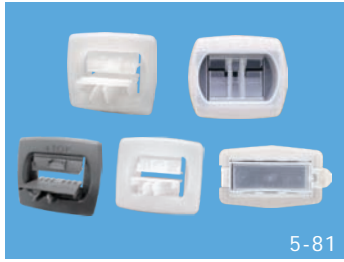

5-81

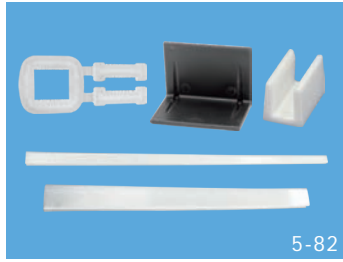

5-82

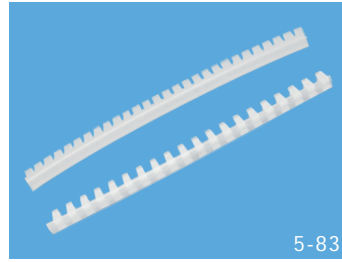

5-83



5-84



5-85

Transistor Washer, Transistor Housing, Parts Housing, Washer, Silicon Insulator Cover, Terminal Soft Sleeves, VCP Cap, Insulated Cap, Tact Switch Cap, Mic Holder

電晶體墊片、電晶體座、零件墊座、華司、矽膠帽套、軟質端子保護套、末端套管、保護蓋、開關蓋、麥克風套



6

Transistor Washer, Transistor Housing, Parts Housing, Washer, Silicon Insulator Cover, Terminal Soft Sleeves, VCP Cap, Insulated Cap, Tact Switch Cap, Mic Holder

電晶體墊片、電晶體座、零件墊座、華司、矽膠帽套、軟質端子保護套、末端套管、保護蓋、開關蓋、麥克風套

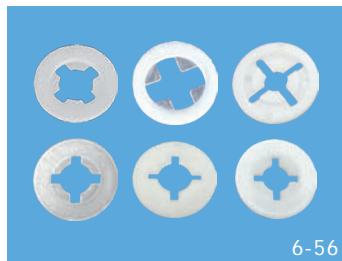
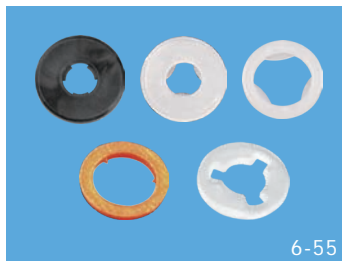
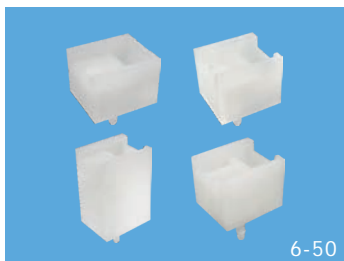
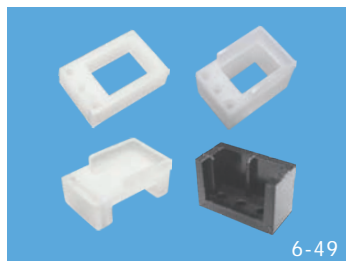
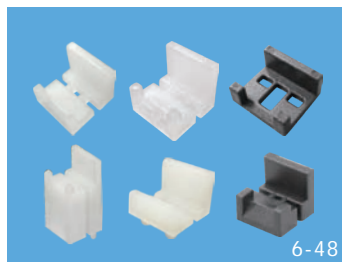
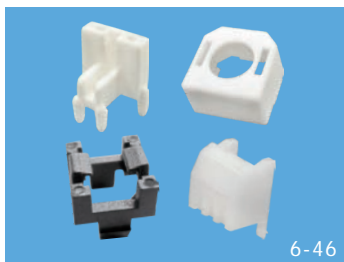
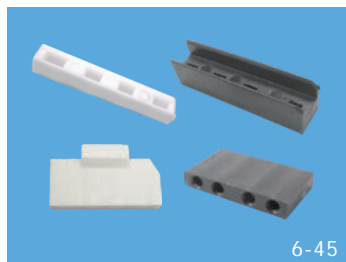
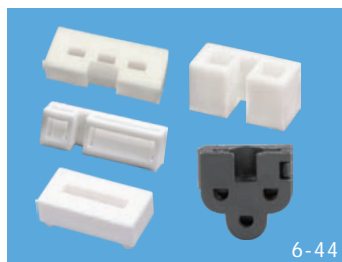
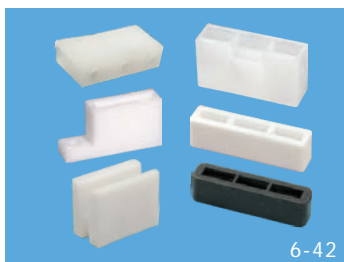
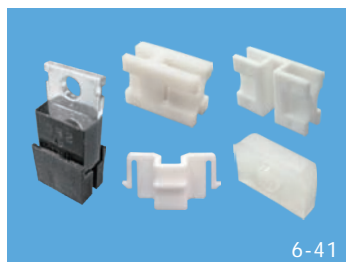
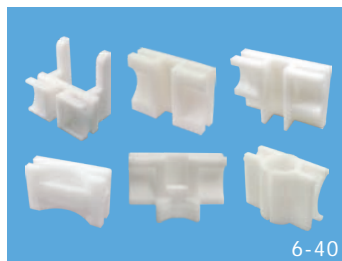
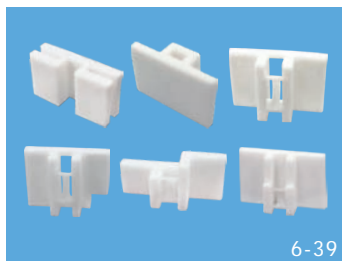
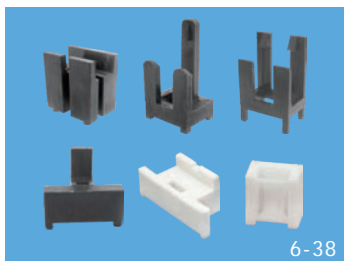
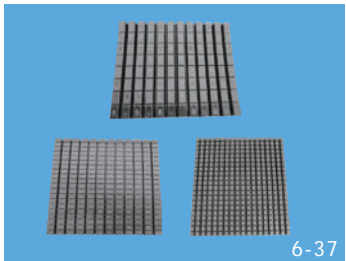
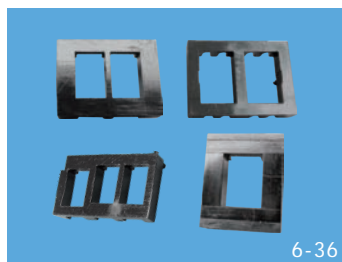
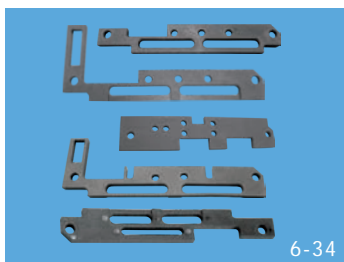
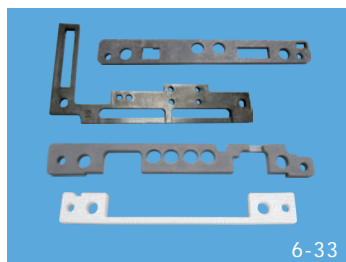

Transistor Washer, Transistor Housing, Parts Housing, Washer, Silicon Insulator Cover, Terminal Soft Sleeves, VCP Cap, Insulated Cap, Tact Switch Cap, Mic Holder

電晶體墊片、電晶體座、零件墊座、華司、矽膠帽套、軟質端子保護套、末端套管、保護蓋、開關蓋、麥克風套

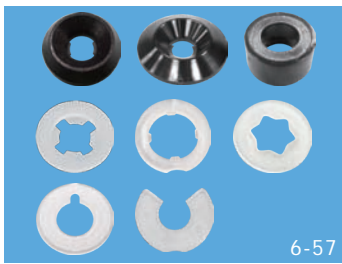

6-57



6-58



6-59

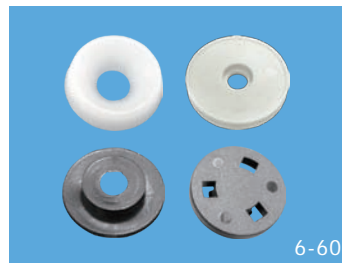

6-60

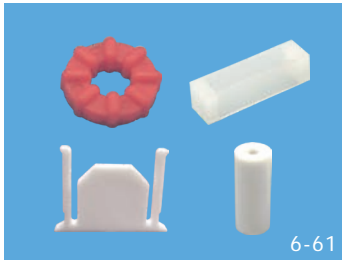

6-61

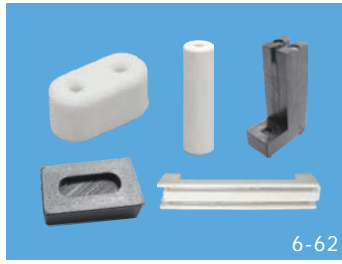

6-62

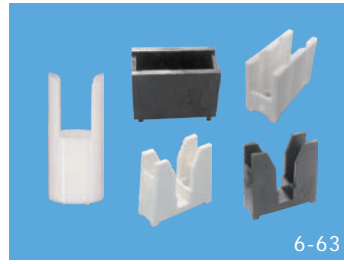

6-63



6-64

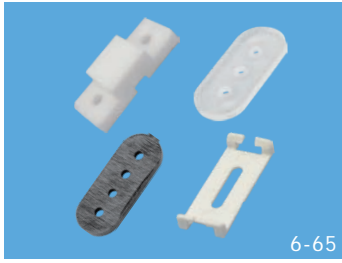

6-65



6-66

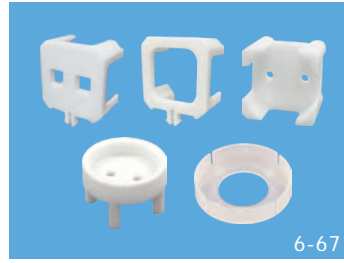

6-67

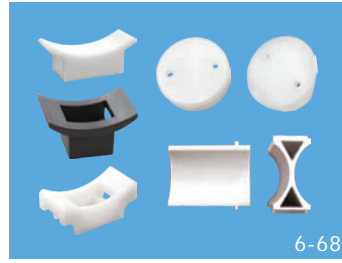

6-68



6-69

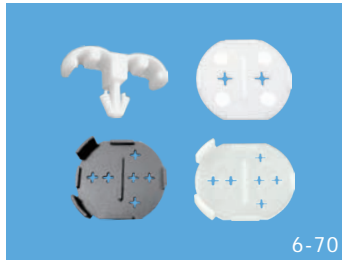

6-70

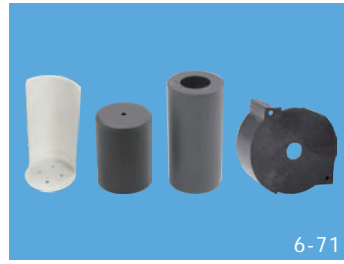

6-71

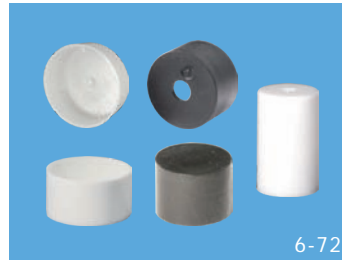

6-72

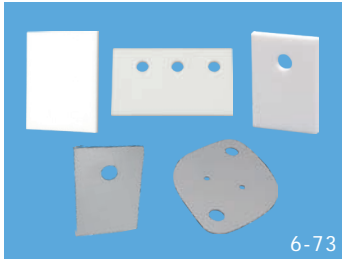

6-73

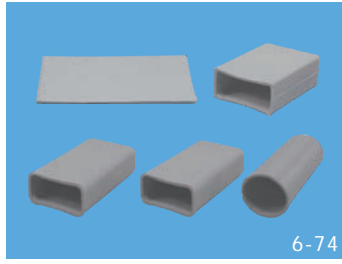

6-74

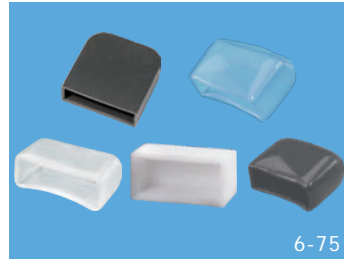

6-75



6-76



6-77



6-78

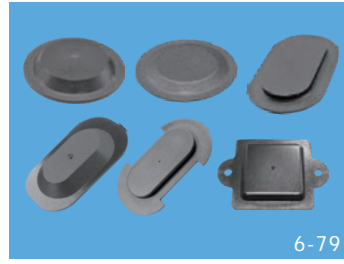

6-79

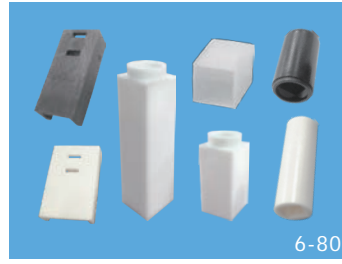

6-80

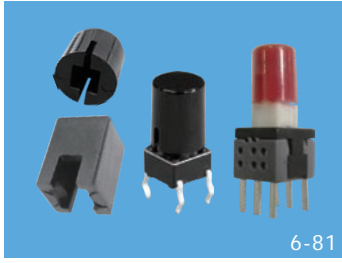

6-81

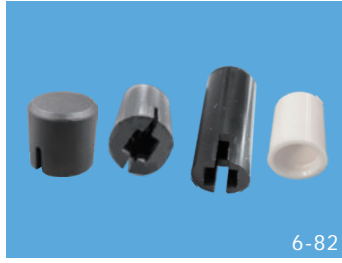

6-82



6-83

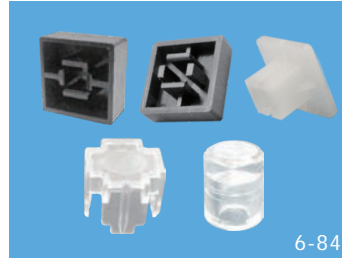

6-84

6

Transistor Washer, Transistor Housing, Parts Housing, Washer, Silicon Insulator Cover, Terminal Soft Sleeves, VCP Cap, Insulated Cap, Tact Switch Cap, Mic Holder

電晶體墊片、電晶體座、零件墊座、華司、矽膠帽套、軟質端子保護套、末端套管、保護蓋、開關蓋、麥克風套



6-85

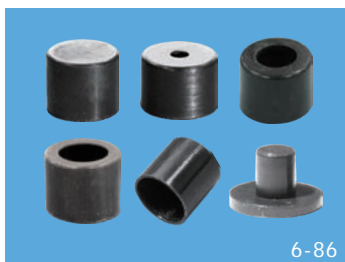

6-86



6-87

7

USB Housing, Connector Cover, Fiber Optic Connector Cover, Power Connector Cover, Plastic Conical Anchors, Snap Rivet, Fan Mount Rivet, Heat Sink Rivet, Door Lock

USB座護蓋、防塵蓋、光纖連接器護套、電源插座防塵蓋、螺絲固定座、鉚釘、風扇鉚釘、散熱片扣件、門扣

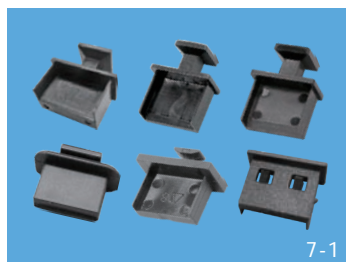

7-1

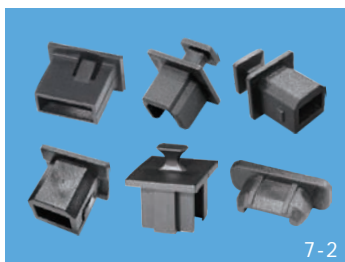

7-2

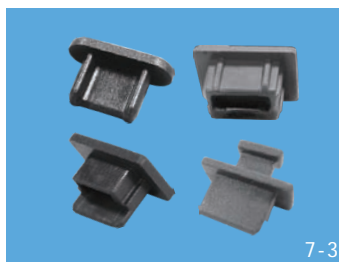

7-3

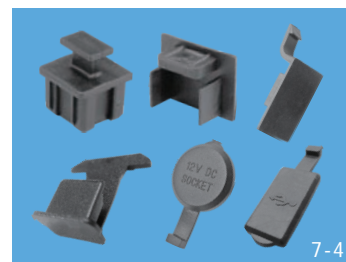

7-4



7-5

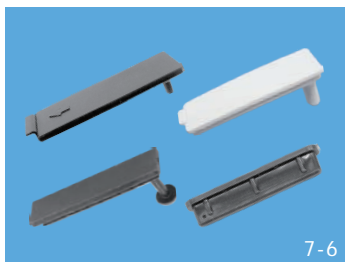

7-6

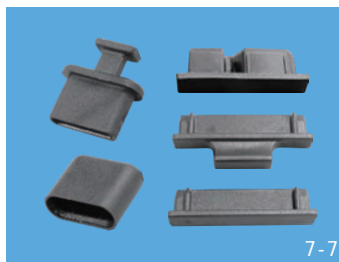

7-7

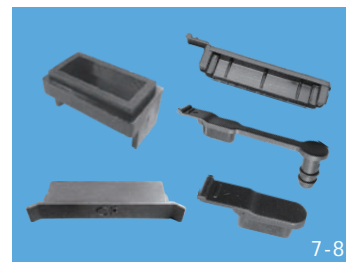

7-8

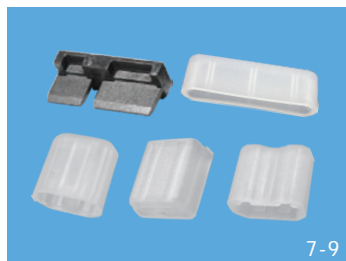

7-9



7-10



7-11



7-12



7-13



7-14

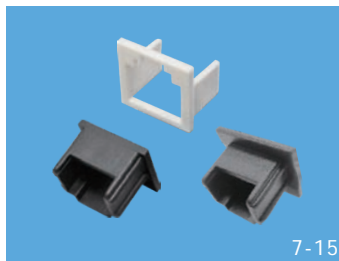

7-15



7-16

USB Housing, Connector Cover, Fiber Optic Connector Cover, Power Connector Cover, Plastic Conical Anchors, Snap Rivet, Fan Mount Rivet, Heat Sink Rivet, Door Lock

USB座護蓋、防塵蓋、光纖連接器護套、電源插座防塵蓋、螺絲固定座、鉚釘、風扇鉚釘、散熱片扣件、門扣

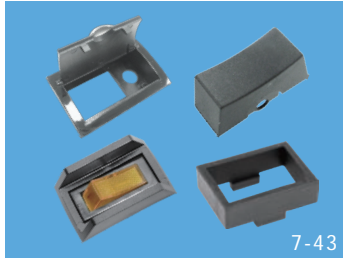
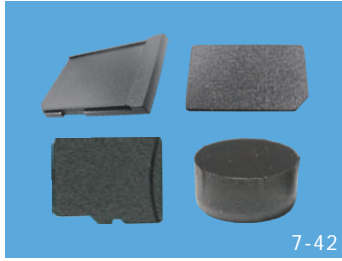
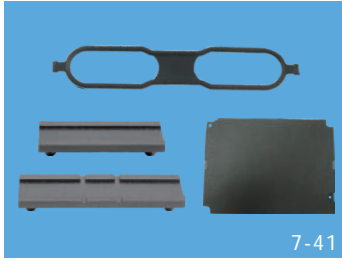
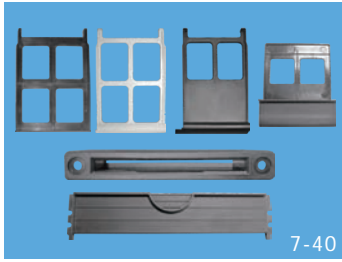
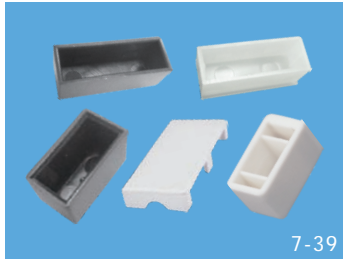
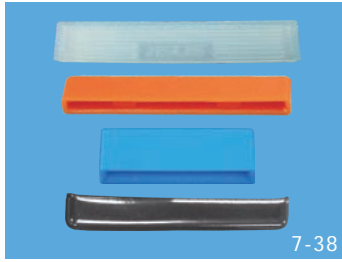
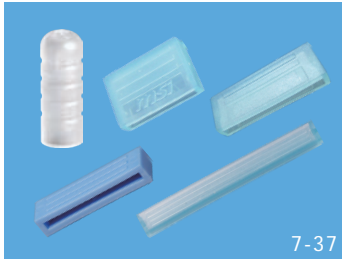
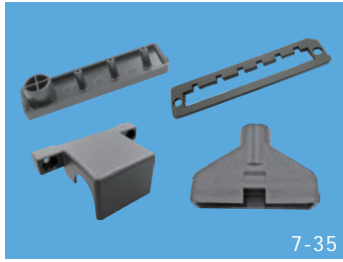
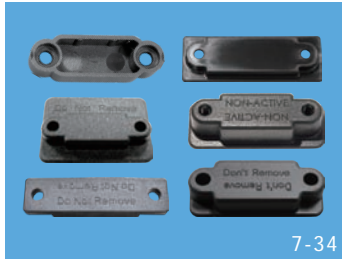
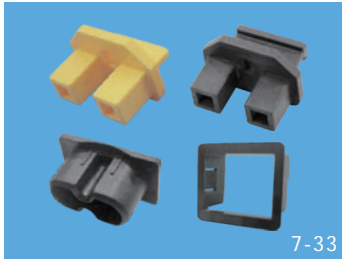
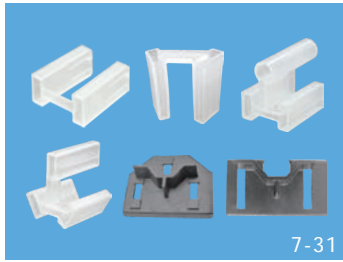
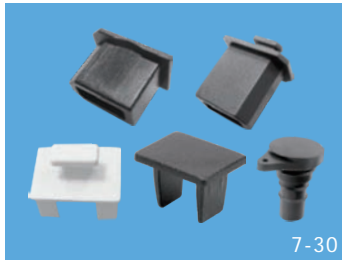
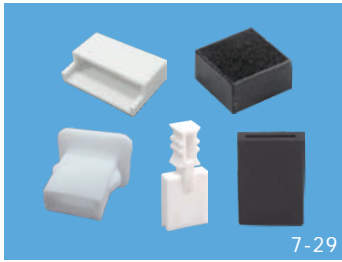
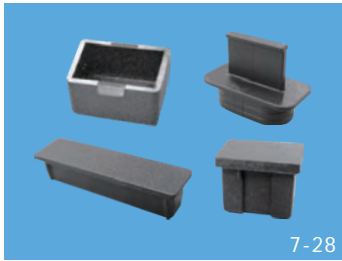
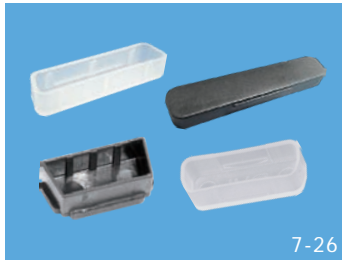
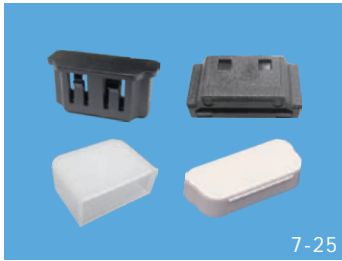
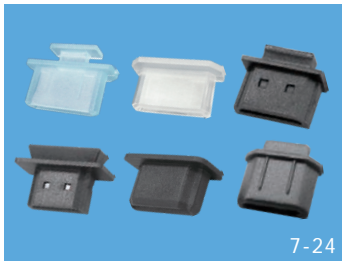
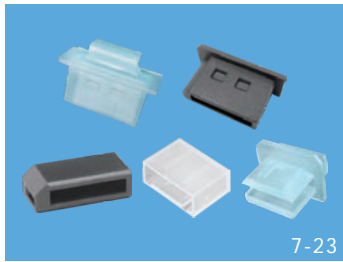
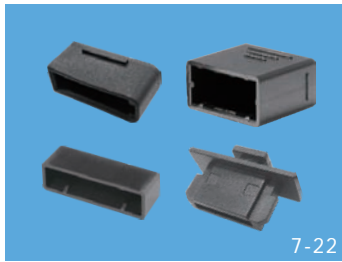
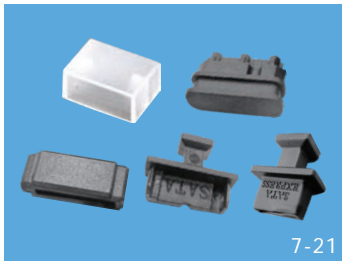
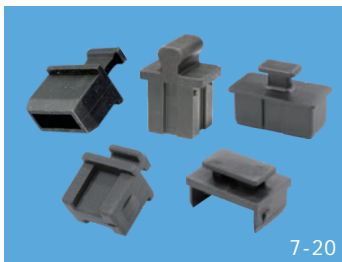
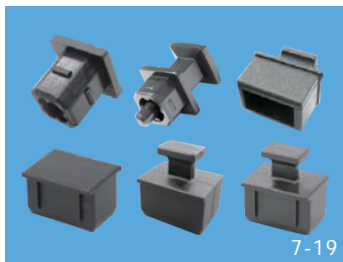
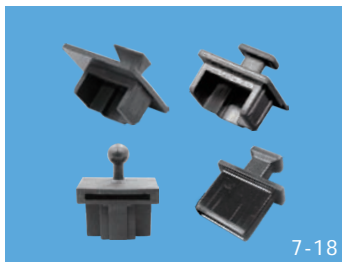
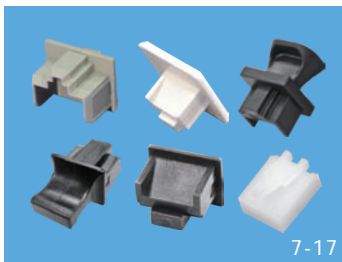

7

USB Housing, Connector Cover, Fiber Optic Connector Cover, Power Connector Cover, Plastic Conical Anchors, Snap Rivet, Fan Mount Rivet, Heat Sink Rivet, Door Lock

USB座護蓋、防塵蓋、光纖連接器護套、電源插座防塵蓋、螺絲固定座、鉚釘、風扇鉚釘、散熱片扣件、門扣

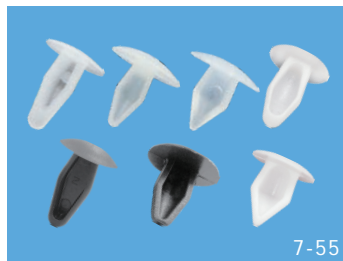
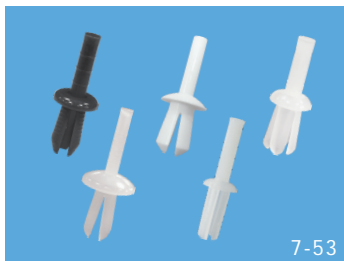
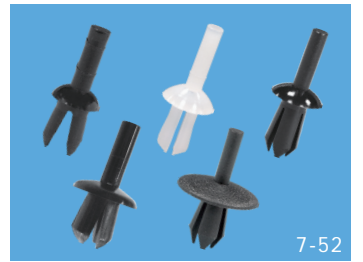

USB Housing, Connector Cover, Fiber Optic Connector Cover, Power Connector Cover, Plastic Conical Anchors, Snap Rivet, Fan Mount Rivet, Heat Sink Rivet, Door Lock

USB座護蓋、防塵蓋、光纖連接器護套、電源插座防塵蓋、螺絲固定座、鉚釘、風扇鉚釘、散熱片扣件、門扣

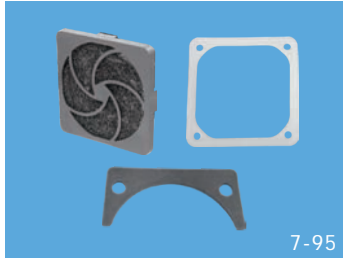
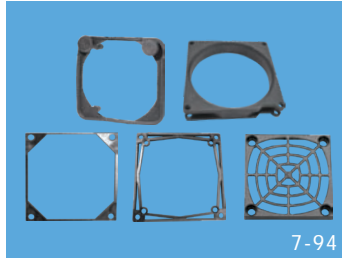
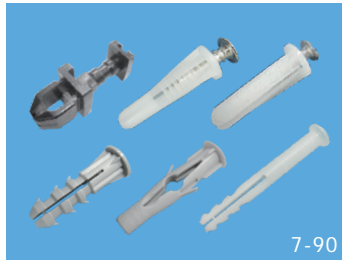
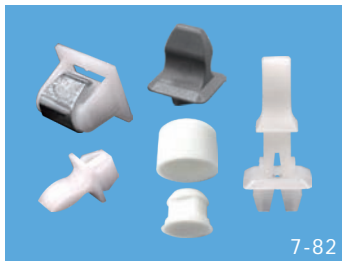
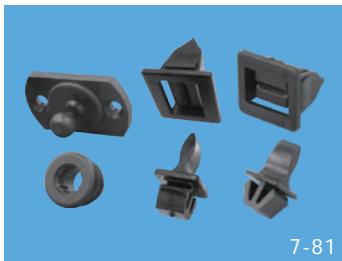

Plastic Screws, Screw Caps & Bonnets, Plastic Nuts, Set Screws & Threaded Rods, Thumb Screws & Knob Screws, Card Puller, PCB Card Guides, Vertical PCB Card Guides

塑膠螺絲、螺絲帽蓋、塑膠螺帽、止付螺絲、手轉螺絲、PC板拉柄、PC板導槽、直立式導槽

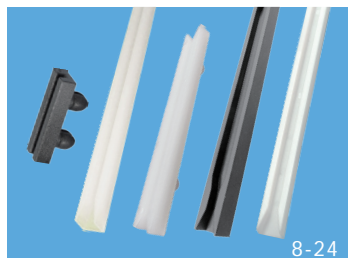
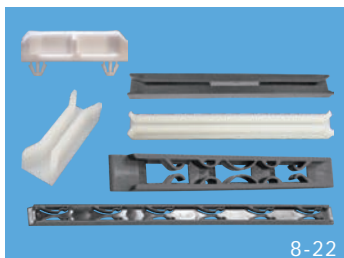
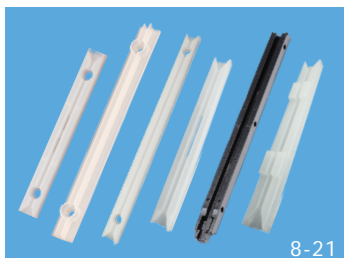
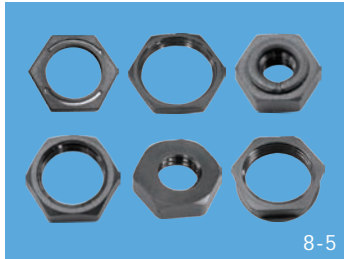

Plastic Screws, Screw Caps & Bonnets, Plastic Nuts, Set Screws & Threaded Rods,
Thumb Screws & Knob Screws, Card Puller, PCB Card Guides, Vertical PCB Card Guides

塑膠螺絲、螺絲帽蓋、塑膠螺帽、止付螺絲、手轉螺絲、PC板拉柄、PC板導槽、直立式導槽

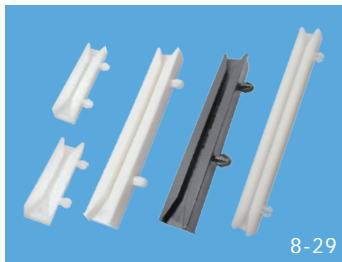

8-29

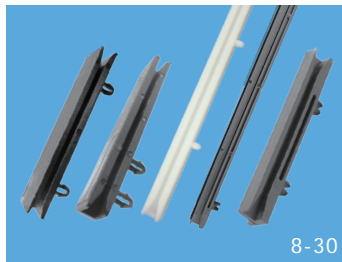

8-30

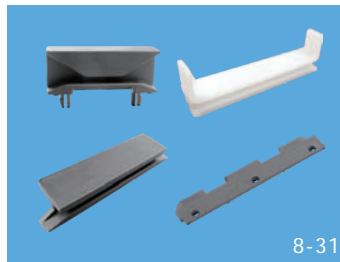

8-31

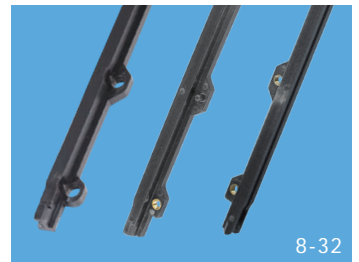

8-32

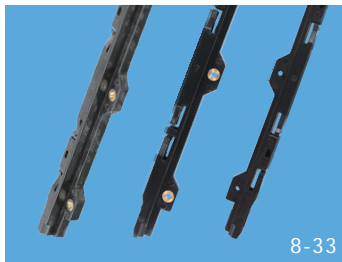

8-33

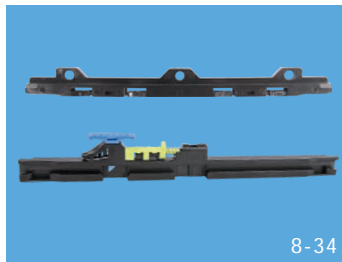

8-34



8-35

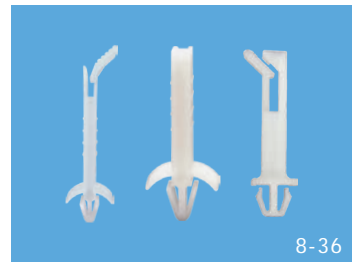

8-36



8-37

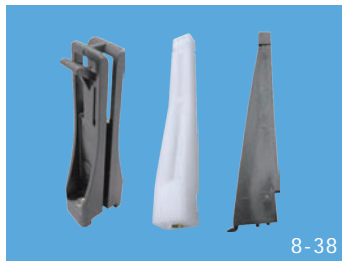

8-38



8-39

9

Plastic Feet, Anti-Vibration Feet, Magnet Plastic Feet, Rubber Feet, Gold/Silver Covering Plastic Feet, Rubber O-rings & Washers, Forms, Transistor Thermal Conductive Pads

腳墊、抗震腳墊、磁鐵腳墊、橡膠腳墊、金框/銀框腳墊、矽橡膠墊圈/華司、泡棉、功率晶體導熱矽膠片

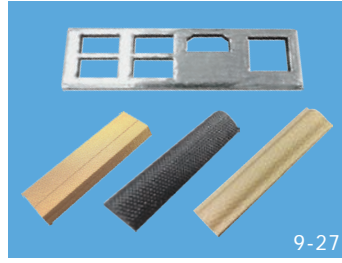
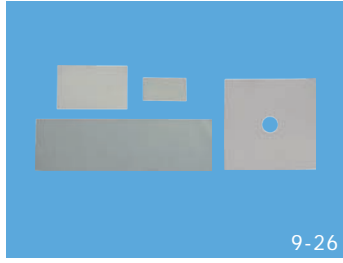
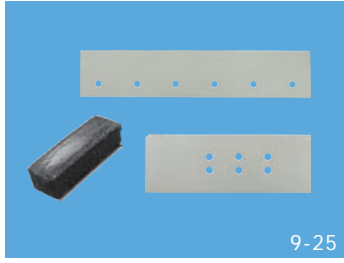
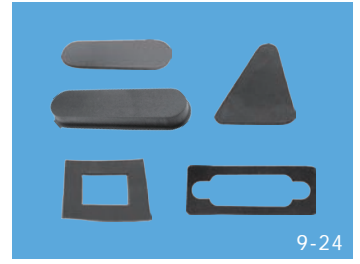
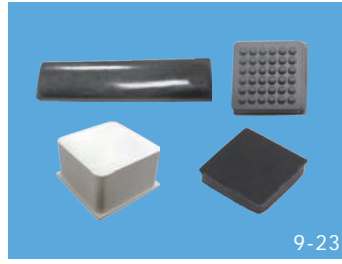
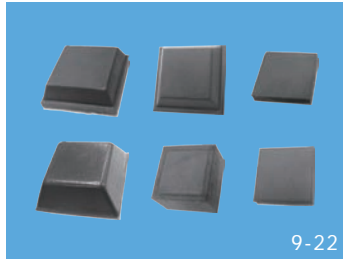
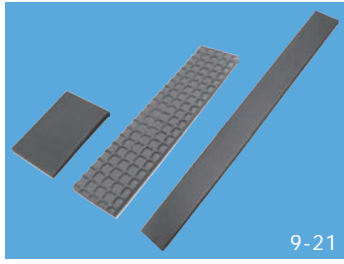
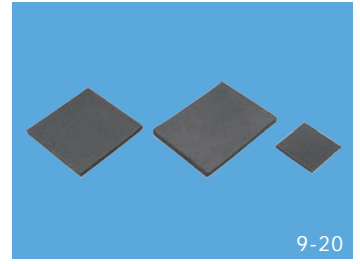
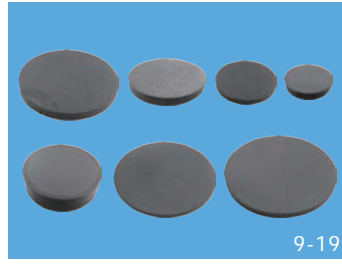
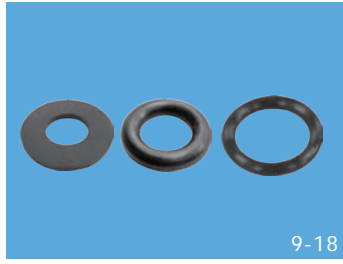
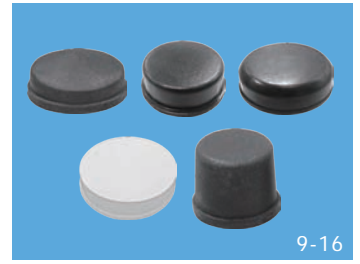
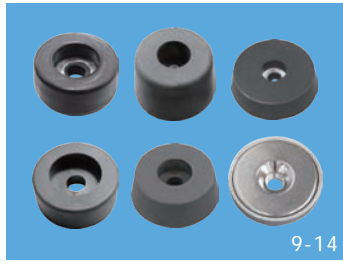
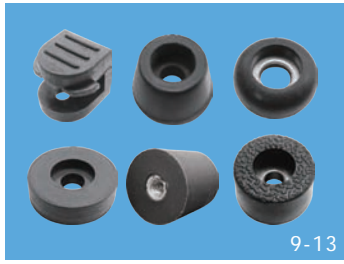
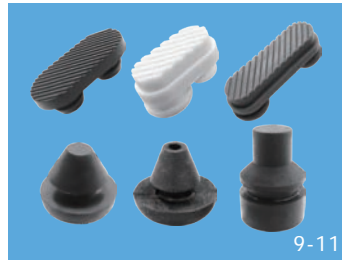
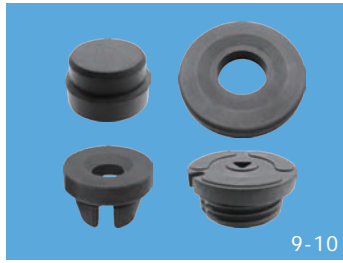
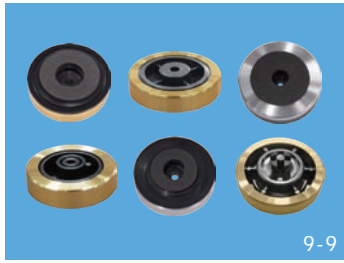
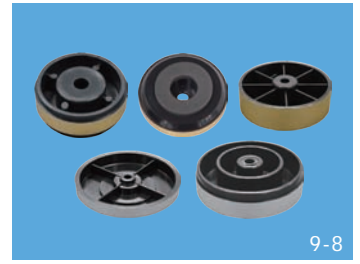
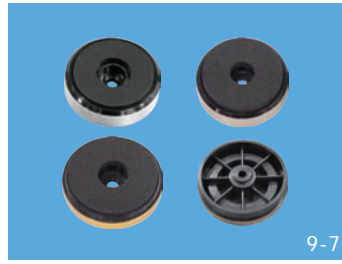
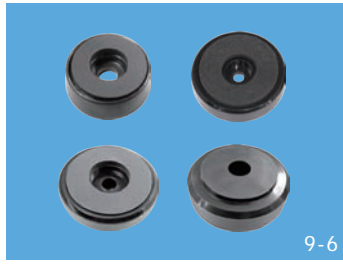
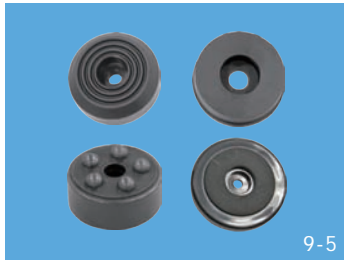
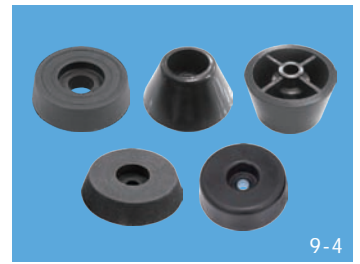
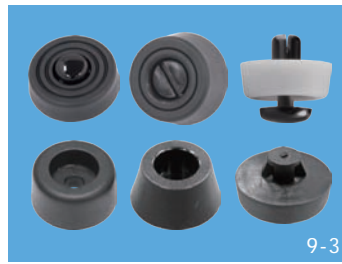
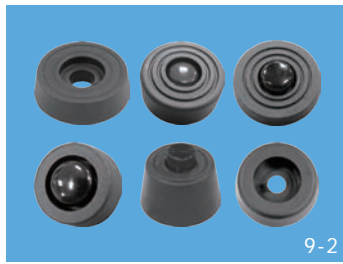

Damper Gears, PCB Terminals, Test Pins, Fuse & Test Holders, Clamps & Clips, Ground Terminals, Terminal Blocks & Connectors, Quick Splices & Jumper Wires, Transistor Clamps

阻尼齒輪、PC板焊接端子、測試針/測試點、保險絲座/測試座、彈片/電晶體夾、接地片、端子台/端子/連接頭、接線夾/跳線、功率晶體壓板

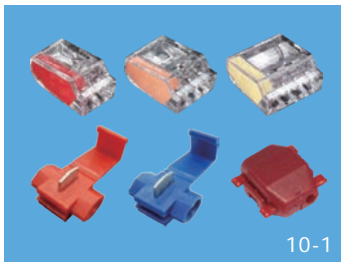

10-1

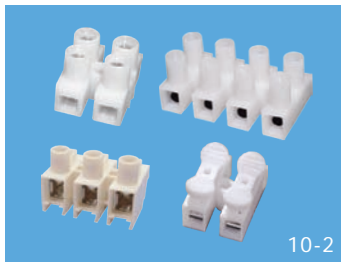

10-2

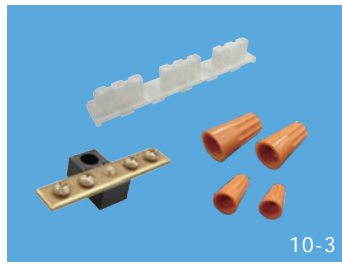

10-3



10-4

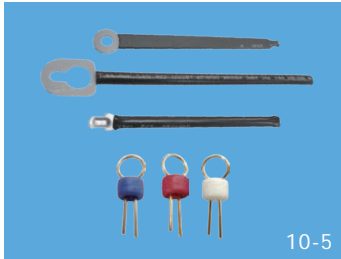

10-5

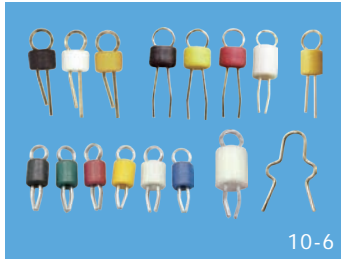

10-6



10-7



10-8



10-9



10-10

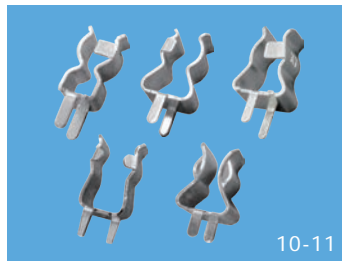

10-11

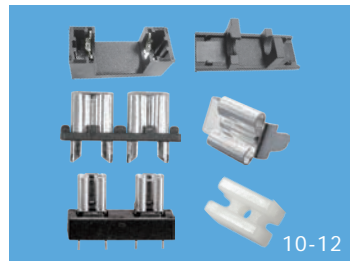

10-12

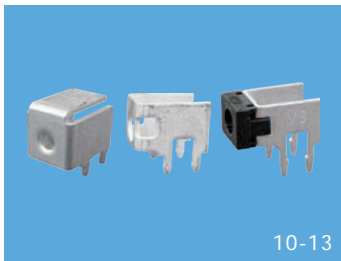

10-13

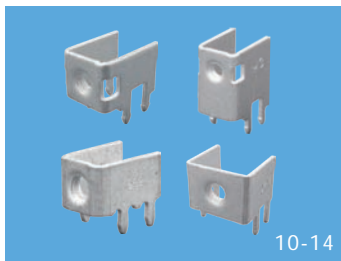

10-14



10-15

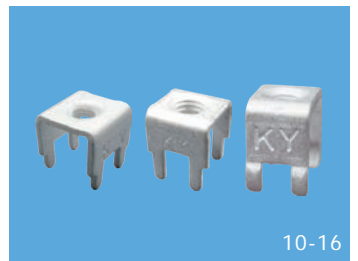

10-16

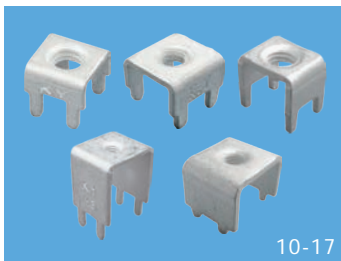

10-17

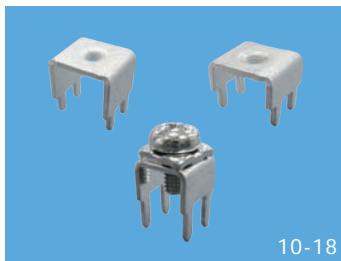

10-18



10-19

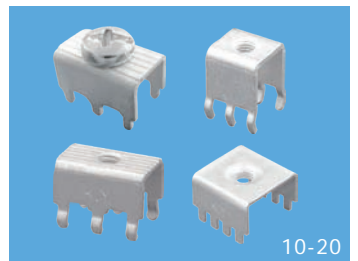

10-20

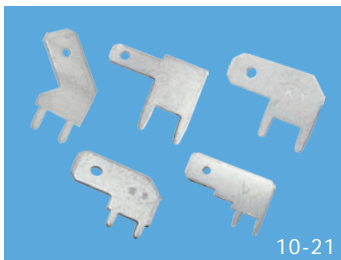

10-21



10-22

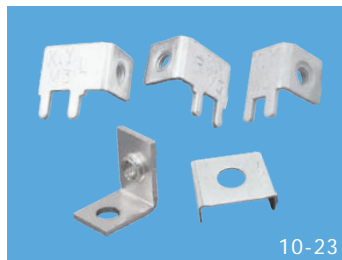

10-23

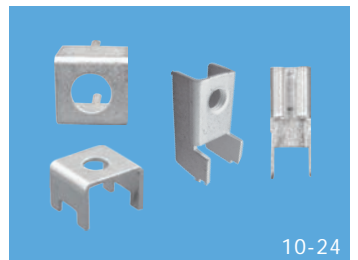

10-24

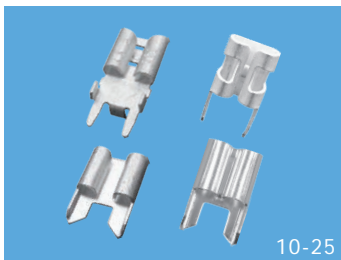

10-25

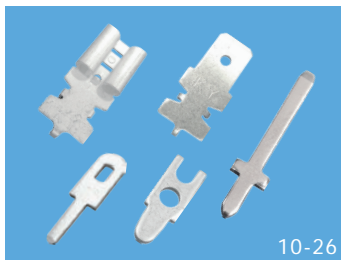

10-26

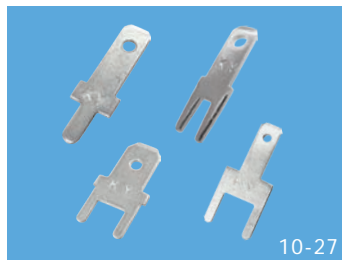

10-27

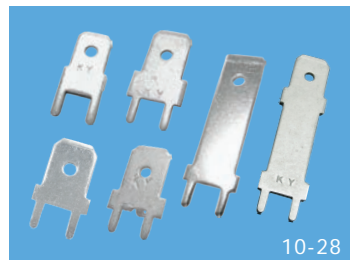

10-28

Damper Gears, PCB Terminals, Test Pins, Fuse & Test Holders, Clamps & Clips, Ground Terminals, Terminal Blocks & Connectors, Quick Splices & Jumper Wires, Transistor Clamps
 阻尼齒輪、PC板焊接端子、測試針/測試點、保險絲座/測試座、彈片/電晶體夾、接地片、端子台/端子/連接頭、接線夾/跳線、功率晶體壓板

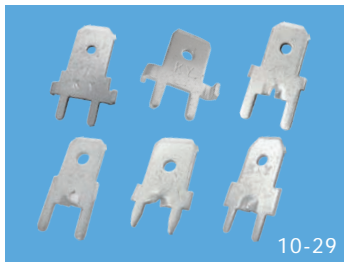

10-29

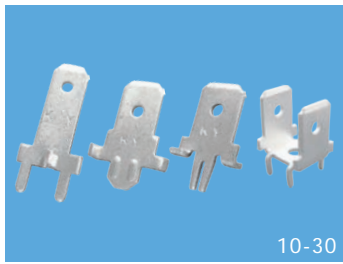

10-30

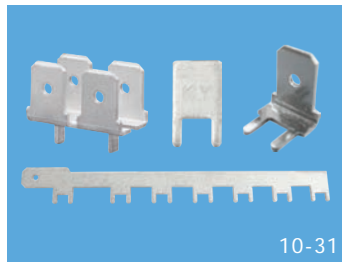

10-31

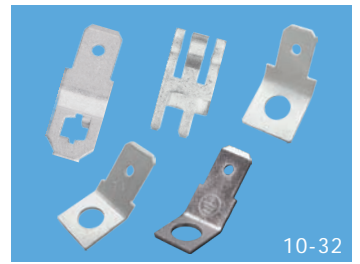

10-32

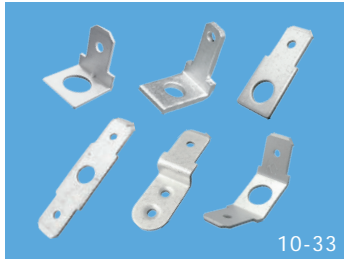

10-33

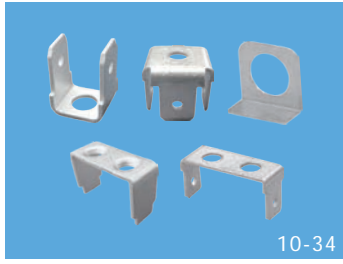

10-34

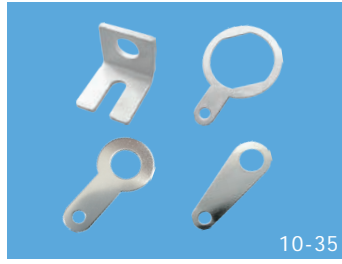

10-35



10-36



10-37



10-38



10-39



10-40

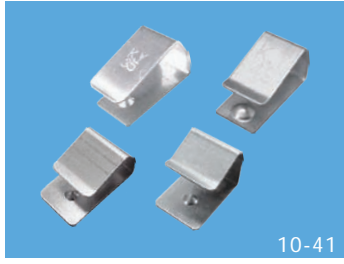

10-41

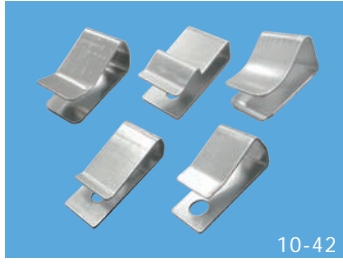

10-42

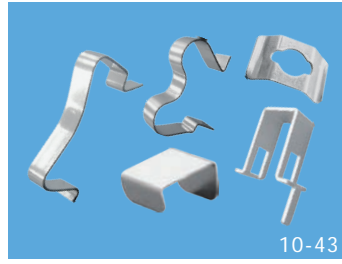

10-43

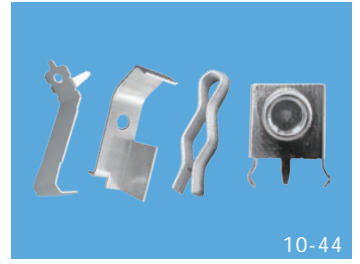

10-44

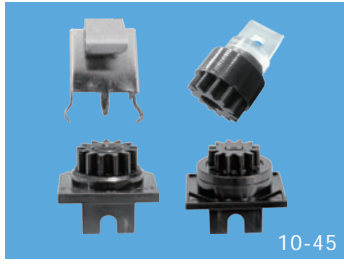

10-45



10-46



10-47



10-48



10-49

1

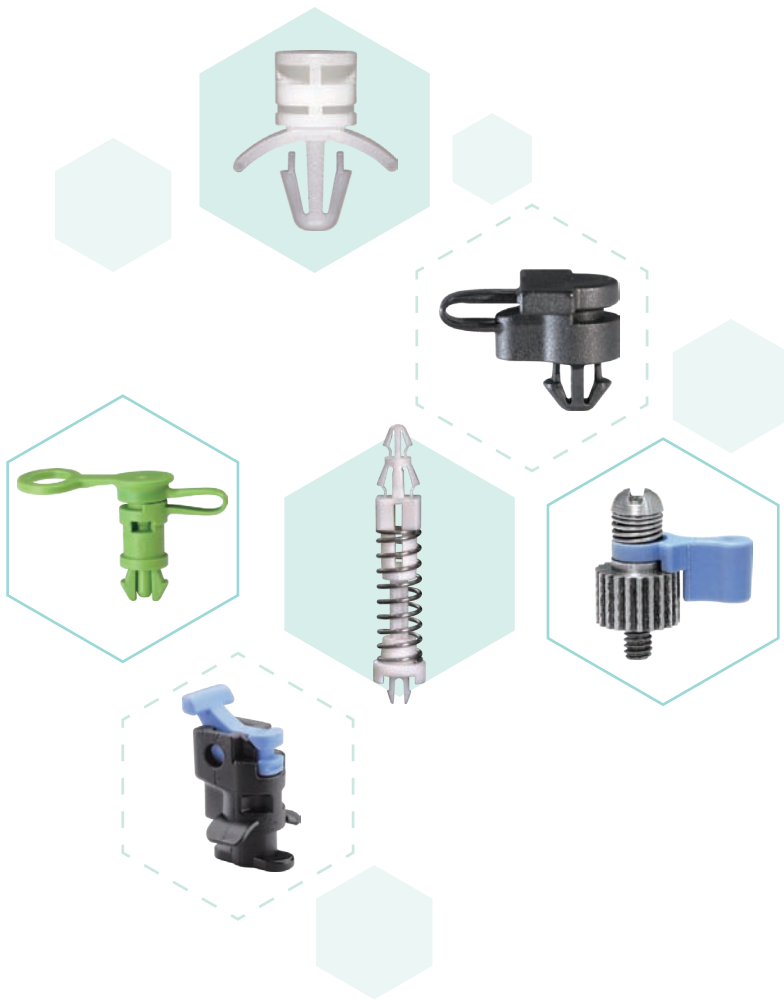

- PC板間隔柱
Spacer Supports
- 導電PC板間隔柱
Conductive
Spacer Supports
- 圓體間隔柱
Round Spacers
- 導光板間隔柱
Pillar Supports
- PC板固定座/扣
PCB Mounting Block &
Hinges
- 銅柱/塑膠銅柱
Standoffs



PC板間隔柱裝配孔快速索引

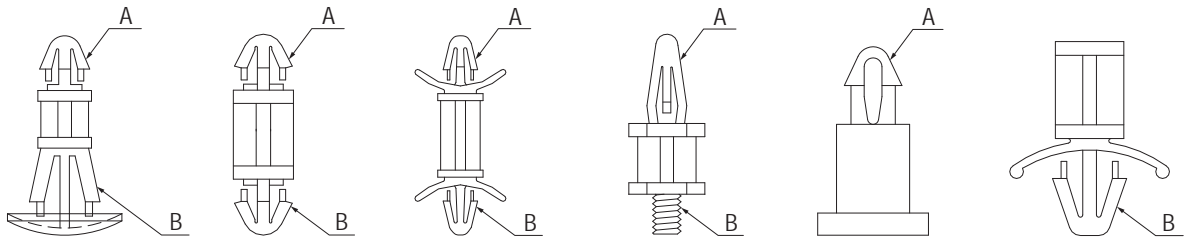

Part No.	A	B	Page	Note
MCIA-		3.2X4.8	1-59	橢圓孔
SOR-3		3.2X6.0	1-74	M2.5 or M2.6 Screw
TCBE-		4.0X5.41	1-60	
KVLM A-10		5.5X7.1	1-58	
KVLM3-		5.5X7.1	1-59	M3X0.5P
KVLM4-10		5.5X7.1	1-59	M4X0.7P
PAA-11		6.0X7.0	1-68	
LJ-4		Ø2.5	1-69	
LBS-		Ø3.0	1-46	
MSA-		Ø3.0	1-48	
TCBA-		Ø3.0	1-51	
LIO-		Ø3.0	1-69	
LIO-8		Ø3.0	1-69	
DCCB-4.1		Ø3.0~Ø3.18	1-51	
MSPE-7		Ø3.2	1-29	
LCUA-11		Ø3.4	1-84	
EDC-		Ø3.5	1-2	
LASE-		Ø3.5	1-47	
LASH-22		Ø3.5	1-47	
LASJ-		Ø3.5	1-47	
SSUL-8		Ø3.5	1-75	
LIES-1		Ø3.8	1-75	
RAMA-		Ø4.0	1-1	
RAMC-		Ø4.0	1-2	
LASB-3.7		Ø4.0	1-46	
LASF-18		Ø4.0	1-48	
TCBC-		Ø4.0	1-59	
TCBH-17F		Ø4.0	1-60	
SOR-2		Ø4.0	1-74	
TCEB3-		Ø4.1	1-65	M3X0.5P
TCEB4-		Ø4.1	1-65	M4X0.7P
TCEB632-		Ø4.1	1-65	6-32 UNC
LCU-18		Ø4.3	1-89	
LASD-8.3		Ø4.5	1-46	
RAD-		Ø4.8	1-1	
RAMD-15.5		Ø4.8	1-3	
LCDS3-		Ø4.8	1-45	M3X0.5P
LCDS4-		Ø4.8	1-46	M4X0.7P
LAS-		Ø4.8	1-47	
LASL-4.8		Ø4.8	1-47	
LASY-		Ø4.8	1-47	
ULCF-		Ø4.8	1-76	
WLCF-		Ø4.8	1-76	
ULCBB-		Ø4.8	1-84	
LASA-9.5		Ø4.8~Ø5.0	1-47	
TCBD-4.8		Ø4.8~Ø5.0	1-60	
CUS-5		Ø5.0	1-74	
RAM-		Ø5.5	1-1	
RAM-13.5L		Ø5.5	1-1	
RAML-		Ø5.5	1-1	
RAS-		Ø5.5	1-2	
SOR-1		Ø5.5	1-74	
RAMB-9		Ø5.6	1-3	

Part No.	A	B	Page	Note
LDD-		Ø6.0	1-77	
MCSH-7.2	2.0X3.0		1-55	
KVD-	4.0X5.5	5.0X6.5	1-21	
MASD-	Ø1.5		1-48	
MASS-	Ø1.5		1-48	
MASSD-	Ø1.5	Ø1.5	1-13	
MAEB-3.2	Ø1.5	Ø3.0	1-19	
LCMB-8	Ø1.5	Ø3.0	1-20	
MADSA-3	Ø1.6	Ø1.6	1-13	
MADSB-3	Ø1.6	Ø1.6	1-13	
MADS-	Ø1.6	Ø2.0	1-13	
MAS-9	Ø1.6	Ø2.0	1-13	
MAD1.7-9.8	Ø1.7	Ø1.7	1-13	
MAL-8	Ø2.0		1-48	
MASL-5.4	Ø2.0		1-48	
MAST-	Ø2.0		1-48	
MA-	Ø2.0		1-49	
MAB-4	Ø2.0		1-49	
MABA-2.6	Ø2.0		1-49	
MA-XXDL	Ø2.0		1-49	
MS-	Ø2.0		1-52	
ISS-	Ø2.0		1-77	Double Adhesive Tape
MAD1-	Ø2.0	Ø2.0	1-13	
MAD1.2-12.9	Ø2.0	Ø2.0	1-13	
MAD-	Ø2.0	Ø2.0	1-14	
MAD1.2-	Ø2.0	Ø2.0	1-14	
MADB-	Ø2.0	Ø2.0	1-14	
MADX-9.5	Ø2.0	Ø2.0	1-14	
MADG-5.4	Ø2.0	Ø2.0	1-36	
MAMDA-	Ø2.0	Ø2.5	1-15	
LCMA-	Ø2.0	Ø3.0~Ø3.2	1-40	
RCAB-	Ø2.0	Ø4.0	1-12	
PCLS-25	Ø2.2		1-52	
MAHA-7	Ø2.2	Ø2.2	1-15	
MSB-2.8	Ø2.3		1-52	
ULCBA-5	Ø2.35	Ø4.0	1-82	
ULCSD-5	Ø2.4	Ø2.8	1-82	
SCBS632-	Ø2.5		1-125	6-32 UNC
MAMS-	Ø2.5		1-49	
MAMS-7.5	Ø2.5		1-49	
MAM-	Ø2.5		1-50	
MSM-2.5	Ø2.5		1-52	
MAE2.5-6.5	Ø2.5		1-53	
MAE2.5-6.5T	Ø2.5		1-53	M2X0.4P
GSS-	Ø2.5		1-77	Double Adhesive Tape
ULCI-11	Ø2.5		1-79	
ULCIJ-4	Ø2.5		1-80	
MADA-18S	Ø2.5	Ø2.5	1-15	
MADAA-14	Ø2.5	Ø2.5	1-15	
MADJ-6	Ø2.5	Ø2.5	1-15	
MADA-	Ø2.5	Ø2.5	1-16	
MADM-	Ø2.5	Ø2.5	1-16	
MAMDF-7	Ø2.5	Ø2.5	1-16	

PC板間隔柱裝配孔快速索引

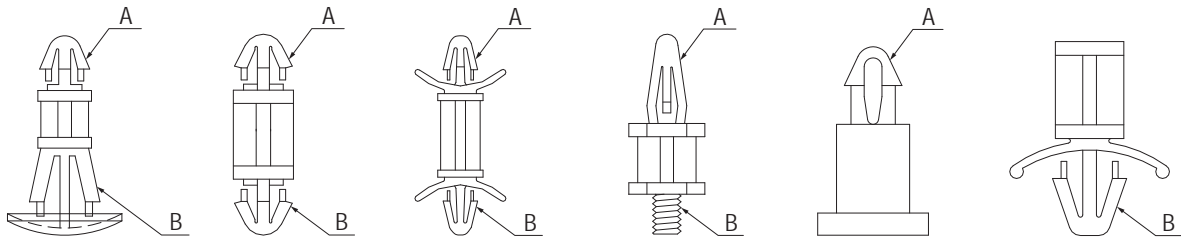

Part No.	A	B	Page	Note
MAMD-9	Ø2.5	Ø2.5	1-16	
MAC-	Ø2.5	Ø2.5	1-17	
MADE-2.8	Ø2.5	Ø2.5	1-17	
MAHC-14.3	Ø2.5	Ø2.5	1-17	
MADMK-5	Ø2.5	Ø2.5	1-20	
LCMC-7	Ø2.5	Ø3.0	1-20	
LCAB-	Ø2.5	Ø3.0	1-40	
LCMD-	Ø2.5	Ø3.0-Ø3.2	1-40	
RCAC-	Ø2.5	Ø4.0	1-12	
MAEE-4.5	Ø2.5	Ø4.0	1-19	
MAM-6.35L	Ø2.6		1-50	
MADAB-4.3	Ø2.6	Ø2.5	1-17	
MADM1-2.2	Ø2.6	Ø2.6	1-17	
MAHC-XXS	Ø2.6	Ø2.6	1-17	
MSPA-1.6	Ø2.6	Ø2.8	1-31	
LCUE-3.3	Ø2.6	Ø3.2	1-83	
MAMA-3.5	Ø2.7		1-50	
LCUAE-16LA	Ø2.8	3.2X4.8	1-87	
MSPA-6.3L	Ø2.8	Ø2.8	1-31	
SCBA-	Ø3.0		1-125	M3X0.5P
SCBD-8	Ø3.0		1-125	M3X0.5P
MSPA3-9.7	Ø3.0		1-126	M3X0.5P
DCC-	Ø3.0		1-50	
DCC-20S	Ø3.0		1-50	
MAL-34	Ø3.0		1-50	
DCE-4	Ø3.0		1-51	
MAE-	Ø3.0		1-53	
MAE-XXT	Ø3.0		1-53	M3X0.5P
MAE-7-440	Ø3.0		1-54	
MAE-7-440T	Ø3.0		1-54	4-40 UNC
DCB-	Ø3.0		1-56	
DCBA-3.5	Ø3.0		1-56	
SS1-	Ø3.0		1-72	M2 Screw
SS3-7(1.3)	Ø3.0		1-72	M2 Screw
BSS-	Ø3.0		1-78	Double Adhesive Tape
CSS-	Ø3.0		1-78	Double Adhesive Tape
CSSA-2	Ø3.0		1-78	Double Adhesive Tape
LCUAC-7	Ø3.0	3.2X4.8	1-86	
LCUAE-12	Ø3.0	3.2X4.8	1-87	橢圓孔
MADL-27.8	Ø3.0	Ø3.0	1-18	
MAMDC-12	Ø3.0	Ø3.0	1-18	
MSPC3-	Ø3.0	Ø3.0	1-21	
MSPC3-3.2L	Ø3.0	Ø3.0	1-21	
MSPF3-	Ø3.0	Ø3.0	1-21	
SSDU1-3.5	Ø3.0	Ø3.0	1-28	
LCJ-	Ø3.0	Ø3.0	1-29	
LCV-	Ø3.0	Ø3.0	1-29	
LCVA-	Ø3.0	Ø3.0	1-29	
LCVU-	Ø3.0	Ø3.0	1-29	
LMSA-6	Ø3.0	Ø3.0	1-32	
CBSA-13	Ø3.0	Ø3.0	1-33	
LCGA-	Ø3.0	Ø3.0	1-33	
LCF-	Ø3.0	Ø3.0	1-34	

Part No.	A	B	Page	Note
LCA-	Ø3.0	Ø3.0	1-37	
LCG-	Ø3.0	Ø3.0	1-41	
LCFO-	Ø3.0	Ø3.5	1-34	
RCI-2.6	Ø3.0	Ø4.0	1-3	
RCO-	Ø3.0	Ø4.0	1-3	
RCA-	Ø3.0	Ø4.0	1-4	
MAEA-3.5	Ø3.0	Ø4.0	1-20	
LCX-31	Ø3.0	Ø4.0	1-30	
LCH-	Ø3.0	Ø4.0	1-37	
RCC-	Ø3.0	Ø4.8	1-4	
LCBT-	Ø3.0	Ø4.8	1-41	
KLCBS-	Ø3.0	Ø4.8	1-42	
LCBUA-13.9	Ø3.0	Ø4.8-Ø5.0	1-41	
RCG-	Ø3.0	Ø5.5	1-5	
DCBA-8	Ø3.1		1-56	
LCUAC-11	Ø3.1	3.2X4.8	1-86	橢圓孔
LCUAE-8	Ø3.1	3.2X4.8	1-86	橢圓孔
MADD-2	Ø3.1	Ø3.0	1-18	
SCB3-	Ø3.2		1-126	M3X0.5P
JSS-	Ø3.2		1-79	Double Adhesive Tape
ULCSE-	Ø3.2	3.2X4.8	1-83	橢圓孔
LCUAC-	Ø3.2	3.2X4.8	1-85	橢圓孔
LCUAC-	Ø3.2	3.2X4.8	1-86	橢圓孔
LCPL-6.4	Ø3.2	Ø2.0	1-32	
LCSE-	Ø3.2	Ø3.0-Ø3.2	1-43	
MADN-24	Ø3.2	Ø3.2	1-18	
MSPB3.2-6.4	Ø3.2	Ø3.2	1-22	
MSPP-	Ø3.2	Ø3.2	1-22	
DMSB-	Ø3.2	Ø3.2	1-24	
DMSS-	Ø3.2	Ø3.2	1-24	
MSP3-	Ø3.2	Ø3.2	1-24	
MSPS3S-7.5	Ø3.2	Ø3.2	1-24	
MSPL-11	Ø3.2	Ø3.2	1-25	
MSPMA-12	Ø3.2	Ø3.2	1-25	
MSPS3-	Ø3.2	Ø3.2	1-25	
LCJ-15	Ø3.2	Ø3.2	1-29	
LMSB-4	Ø3.2	Ø3.2	1-32	
LMSE-4.8	Ø3.2	Ø3.2	1-32	
LMSP-	Ø3.2	Ø3.2	1-32	
RCMB-2.8	Ø3.2	Ø4.0	1-5	
LCUAD-1	Ø3.2	Ø4.1	1-84	
ULCSF-	Ø3.2	Ø4.2	1-82	
RCBS-	Ø3.2	Ø4.8	1-8	
RCR-3.2	Ø3.2	Ø4.8	1-8	
RCV-11.1	Ø3.2	Ø4.8	1-8	
RCW-	Ø3.2	Ø4.8	1-8	
ULCD-7.8	Ø3.3		1-80	M3X0.5P
MSPD-	Ø3.3	3.2X4.8	1-26	橢圓孔
MSPN-	Ø3.3	3.2X4.8	1-26	橢圓孔
MSPQ-16	Ø3.3	3.2X4.8	1-26	橢圓孔
LMSD-	Ø3.3	3.2X4.8	1-45	橢圓孔
ULCH-2	Ø3.3	3.2X4.8	1-80	M2.5 Screw
ULCSA-	Ø3.3	3.2X4.8	1-81	

PC板間隔柱裝配孔快速索引

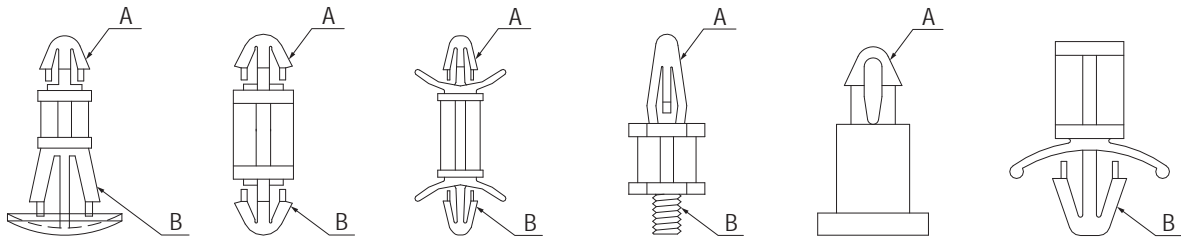

Part No.	A	B	Page	Note
ULCSA-28.8S	Ø3.3	3.2X4.8	1-82	
KEMS-11.3	Ø3.3	5.5X5.5	1-88	
MSPB-	Ø3.3	Ø3.2	1-22	
MSPH-7.5	Ø3.3	Ø3.2	1-26	
MSPF3.3-8L	Ø3.3	Ø3.3	1-22	
MSPCA-16	Ø3.3	Ø3.3	1-23	
MSPCA3.3-	Ø3.3	Ø3.3	1-23	
MSPF3.3-	Ø3.3	Ø3.3	1-23	
DMSC-4.5	Ø3.3	Ø3.3	1-25	
LCOA-28.8	Ø3.3	Ø3.3	1-33	
SCB3-38	Ø3.4		1-126	M3X0.5P
LCIA-3.5	Ø3.4	Ø3.7	1-30	
RCCA-8	Ø3.4	Ø4.8	1-5	
ULCBA-7.8	Ø3.4	Ø4.8	1-83	
SCBB-3	Ø3.5		1-125	M3X0.5P
SCBC-	Ø3.5		1-125	M3X0.5P
MCM-	Ø3.5		1-51	
PDC-	Ø3.5		1-56	
MCN-10	Ø3.5		1-57	
PDC-	Ø3.5		1-57	
PDC-XXD	Ø3.5		1-57	
FSL-25	Ø3.5		1-78	Double Adhesive Tape
FSS-	Ø3.5		1-78	Double Adhesive Tape
FSSA-15	Ø3.5		1-78	
LCPLB-11	Ø3.5	Ø2.6	1-32	
MAD3.5-12	Ø3.5	Ø3.5	1-19	
MAF-	Ø3.5	Ø3.5	1-19	
MAFA-6	Ø3.5	Ø3.5	1-19	
MDLS-4.5	Ø3.5	Ø3.5	1-19	
MAMDD-6	Ø3.5	Ø3.5	1-20	
LCI-	Ø3.5	Ø3.5	1-30	
LDE-33	Ø3.5	Ø3.5	1-30	
CBCS-14	Ø3.5	Ø3.5	1-34	
LCD-	Ø3.5	Ø3.5	1-34	
LCO-	Ø3.5	Ø3.5	1-35	
CBSS-	Ø3.5	Ø3.5	1-37	
LCPA-8.2	Ø3.5	Ø4.0	1-44	
LCBU-	Ø3.5	Ø4.8	1-41	
KLCBM-	Ø3.5	Ø4.8	1-42	
RCT-	Ø3.5	Ø4.8-Ø5.0	1-10	
RCH-	Ø3.5	Ø5.5	1-5	
RCTA-4.5	Ø3.5	Ø5.5	1-10	
DCCA-4.3	Ø3.7		1-51	
UCBS-5A	Ø3.8	Ø4.8	1-44	
MSMA-3.5	Ø3.9		1-52	
MSP-15.9S	Ø3.9	Ø3.9	1-27	
MSPV-3	Ø3.9	Ø3.9	1-27	
MSPY-12.7	Ø3.96	Ø3.96	1-27	
MSPG3-	Ø3.9-Ø4.0		1-126	M3X0.5P
MSPG4-	Ø3.9-Ø4.0		1-126	M4X0.7P
MSPS-	Ø3.9-Ø4.0		1-126	6-32 UNC
MSPS-	Ø4.0		1-126	6-32 UNC
SCB-	Ø4.0		1-127	6-32 UNC

Part No.	A	B	Page	Note
SCB4-	Ø4.0		1-127	M4X0.7P
SCB-6SM3	Ø4.0		1-127	M3X0.5P
SCB832-	Ø4.0		1-127	8-32 UNC
MCO-16	Ø4.0		1-51	
MAE43-	Ø4.0		1-54	M3X0.5P
MAE43-4.8LT	Ø4.0		1-54	
MAE43-XXT	Ø4.0		1-54	M3X0.5P
MAE4D-6	Ø4.0		1-54	
MAE4D-6T	Ø4.0		1-54	M3X0.5P
MAE4-	Ø4.0		1-55	
MAE4-XXT	Ø4.0		1-55	M4X0.7P
MCI-4.7	Ø4.0		1-55	
MC-	Ø4.0		1-57	
MC-	Ø4.0		1-58	
MCE-1.9	Ø4.0		1-58	
MCEA-1.9	Ø4.0		1-58	
MCH-	Ø4.0		1-58	
TCBS-	Ø4.0		1-62	M3 Screw
TCBS-18	Ø4.0		1-62	M3 Screw
TCBT-	Ø4.0		1-62	M3 Screw
TCBT-16	Ø4.0		1-62	4-40 UNC
TCBT-3.6	Ø4.0		1-62	
TCBT-7	Ø4.0		1-62	4-40 UNC
BS-	Ø4.0		1-63	
BS-10-1	Ø4.0		1-63	M3.5-M4 Screw
BS-20-1	Ø4.0		1-63	M3.5-M4 Screw
BS-35.7	Ø4.0		1-63	M3.5 Screw
MBS-	Ø4.0		1-63	
BSB-6	Ø4.0		1-64	
BSCL-9.5	Ø4.0		1-64	
SRLCB-	Ø4.0		1-64	
BSB632-15.9	Ø4.0		1-66	6-32 UNC
BSC632-	Ø4.0		1-66	6-32 UNC
BSCB-	Ø4.0		1-66	M3X0.5P
BSCB-20	Ø4.0		1-66	M3X0.5P
BSCB4-	Ø4.0		1-66	M4X0.7P
BSCM4-	Ø4.0		1-67	M4X0.7P
BSD632-	Ø4.0		1-67	6-32 UNC
BSDM4-	Ø4.0		1-67	M4X0.7P
SS2-	Ø4.0		1-72	M2.6 Screw
SS2-2.5U	Ø4.0		1-72	M2 Screw
ASS-	Ø4.0		1-79	Double Adhesive Tape
ULCBM4-9.5	Ø4.0		1-81	M4X0.7P
ULCC-	Ø4.0		1-81	M3 Screw
LCBL-8	Ø4.0		1-89	
LCBA-	Ø4.0	2.7X7.2	1-42	
ULCH-1	Ø4.0	4.0X6.8	1-80	
LCSI-10	Ø4.0	5.5X5.5	1-45	
KEML-	Ø4.0	5.5X5.5	1-88	
PCC-11	Ø4.0	6.0X7.0	1-68	
PCC-6	Ø4.0	6.0X7.0	1-68	
RCFA-7	Ø4.0	6.3X6.3	1-10	
KES-15	Ø4.0	6.5X7.0	1-84	

PC板間隔柱裝配孔快速索引

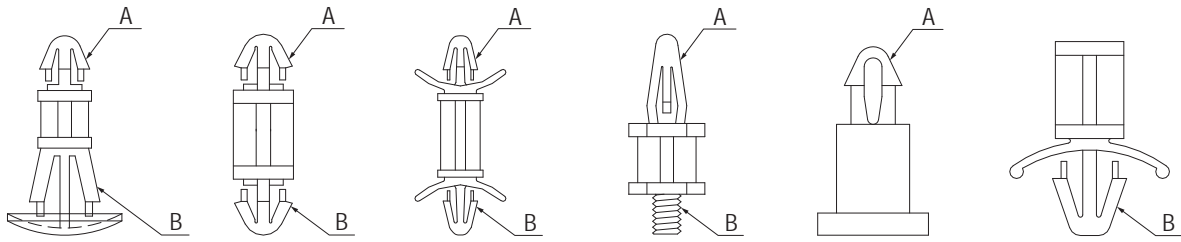

Part No.	A	B	Page	Note
D MSP-	Ø4.0	Ø4.0	1-27	
D MSPS-	Ø4.0	Ø4.0	1-27	
MSP-	Ø4.0	Ø4.0	1-27	
SP1-4.8	Ø4.0	Ø4.0	1-27	
DMSA-9	Ø4.0	Ø4.0	1-28	
MSP1-	Ø4.0	Ø4.0	1-28	
MSPM-	Ø4.0	Ø4.0	1-28	
SSDUA-16.5	Ø4.0	Ø4.0	1-28	
LCK-1	Ø4.0	Ø4.0	1-30	
LCC-	Ø4.0	Ø4.0	1-31	
LCSF-15	Ø4.0	Ø4.0	1-33	
LCBJ-9	Ø4.0	Ø4.0	1-35	
LCFB-8	Ø4.0	Ø4.0	1-35	
LCTA-	Ø4.0	Ø4.0	1-35	
LCEO-	Ø4.0	Ø4.0	1-36	
CBLSS-	Ø4.0	Ø4.0	1-37	
CBSB-45	Ø4.0	Ø4.0	1-38	
LCL-3.2	Ø4.0	Ø4.0	1-38	
LCGB-17.5	Ø4.0	Ø4.0	1-41	
LCSJ-16	Ø4.0	Ø4.0	1-43	
WBHB-1.8	Ø4.0	Ø4.0	1-68	
ULCE-9	Ø4.0	Ø4.0	1-83	
MSPR-3	Ø4.0	Ø4.0	1-91	
LCT-9	Ø4.0	Ø4.5	1-36	
DRCB-18	Ø4.0	Ø4.5~Ø5.0	1-11	
LCSH-9.5	Ø4.0	Ø4.7	1-43	
LCSA-	Ø4.0	Ø4.75	1-43	
RCD-	Ø4.0	Ø4.8	1-6	
MSPK45-	Ø4.0	Ø4.8	1-28	
LCBM-	Ø4.0	Ø4.8	1-31	
LCBD-12.7	Ø4.0	Ø4.8	1-36	
LCBZ-	Ø4.0	Ø4.8	1-36	
CBS-	Ø4.0	Ø4.8	1-38	
LCB-	Ø4.0	Ø4.8	1-38	
LCBSA-	Ø4.0	Ø4.8	1-38	
LCBB-	Ø4.0	Ø4.8	1-39	
LCBS-	Ø4.0	Ø4.8	1-39	
VCBS-	Ø4.0	Ø4.8	1-39	
VCBSL-	Ø4.0	Ø4.8	1-39	
VCBA-14.4F	Ø4.0	Ø4.8	1-40	
KLCBL-	Ø4.0	Ø4.8	1-42	
LCBC-8	Ø4.0	Ø4.8	1-42	
HLCS-	Ø4.0	Ø4.8	1-43	
LCS-	Ø4.0	Ø4.8	1-43	
LCSD-	Ø4.0	Ø4.8	1-44	
LCSL-4.8	Ø4.0	Ø4.8	1-44	
LCSLR-9.5	Ø4.0	Ø4.8	1-44	
LCP-	Ø4.0	Ø4.8	1-44	
LCPD-	Ø4.0	Ø4.8	1-44	
LCY-4.8	Ø4.0	Ø4.8	1-44	
UCBS-	Ø4.0	Ø4.8	1-44	
ULCB-	Ø4.0	Ø4.8	1-85	
RCS-	Ø4.0	Ø5.0	1-6	

Part No.	A	B	Page	Note
RCWA-	Ø4.0	Ø5.4	1-8	
PCBS-6.4	Ø4.0	Ø5.4	1-9	
RCJ-	Ø4.0	Ø5.4	1-11	
RCTL-	Ø4.0	Ø5.4	1-11	
UCBSL-	Ø4.0	Ø5.4	1-45	
RCMA-3	Ø4.0	Ø5.5	1-5	
RCB-	Ø4.0	Ø5.5	1-6	
RCB-11.5	Ø4.0	Ø5.5	1-6	
RCBL-6	Ø4.0	Ø5.5	1-6	
RCI-5	Ø4.0	Ø5.5	1-6	
RCM-	Ø4.0	Ø5.5	1-7	
RCMD-6	Ø4.0	Ø5.5	1-7	
PCBS-	Ø4.0	Ø5.5	1-9	
PCBS-3	Ø4.0	Ø5.5	1-9	
PCBT-	Ø4.0	Ø5.5	1-9	
RCR-12.7	Ø4.0	Ø5.5	1-9	
RBS-	Ø4.0	Ø5.5	1-11	
RBT-	Ø4.0	Ø5.5	1-11	
RCF-	Ø4.0	Ø6.0	1-7	
PCBTA-4.8	Ø4.0	Ø6.0	1-9	
RCFL-	Ø4.0	Ø6.0	1-10	
ACBW-6.8	Ø4.0	Ø6.0	1-67	
ACBR-6	Ø4.0	Ø6.1~Ø6.4	1-60	
RCRA-9.5	Ø4.0	Ø6.35	1-9	
RCFB-10	Ø4.0	Ø6.5	1-10	
ACB-	Ø4.0	Ø6.5	1-61	
MCB-6	Ø4.0	Ø6.5	1-61	
RCQC-7	Ø4.0	Ø7.0	1-24	
WBHC-6.4	Ø4.0	Ø7.9	1-67	
WBH-	Ø4.0	Ø7.9	1-68	
SRLA-	Ø4.1	Ø4.75~Ø4.8	1-65	
BSB-8.5	Ø4.2		1-64	
TCBT-19	Ø4.5		1-62	M3 Screw
MTD-11	Ø4.5		1-63	
MBC-11	Ø4.5	Ø6.5	1-61	
MBD-10	Ø4.5~Ø4.8	Ø16.5	1-61	
MCL-	Ø4.8		1-58	
SS-	Ø4.8		1-73	M3 Screw
SSA-12.7	Ø4.8		1-73	
MSPK4.8-	Ø4.8	Ø4.8	1-28	
LCBY-	Ø4.8	Ø4.8	1-36	
LCBYR-4.8	Ø4.8	Ø4.8	1-36	
MAFB5-	Ø5.0	Ø5.0	1-19	
SSDU-	Ø5.2	Ø5.2	1-29	
RCWB-21	Ø5.3	Ø9.0	1-8	
SSA4-5.5	Ø5.8		1-73	M3.5 or M4 Screw
SS3.5-	Ø5.9		1-73	M3.5 Screw
SS4-	Ø5.9		1-73	M3.5 or M4 Screw
SSU4-	Ø5.9		1-73	M4 Screw
SSUA4-6.3L	Ø6.0		1-73	M4 Screw
RCBC-12	Ø6.2	Ø9.0	1-8	

PC板間隔柱 SPACER SUPPORT

用途：一端固定於機板上，另一端支撐PC板，避免下陷造成短路，PC板免鑽孔。

- Material: Nylon 66 (UL)
- Flame Class: 94V-2/94V-0
- Color: Natural/Black
- Unit: mm

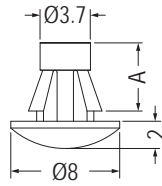
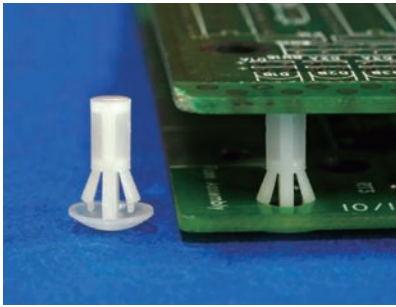

MOUNTING HOLE $\varnothing 4.0$
THICKNESS 0.8-1.6

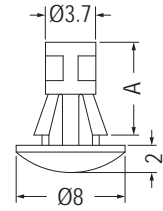

MOUNTING HOLE $\varnothing 4.0$
THICKNESS 0.8-1.6

Part No.	A	Package
RAMA-3	3.2	1000
RAMA-4.5	4.5	
RAMA-5.5	5.5	

Part No.	A	Package
RAMA-6.4	6.4	1000
RAMA-7	7.0	
RAMA-7.5	7.5	
RAMA-9.5	9.5	
RAMA-11.1	11.1	
RAMA-12.7	12.7	

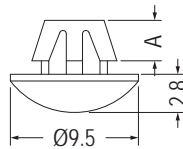
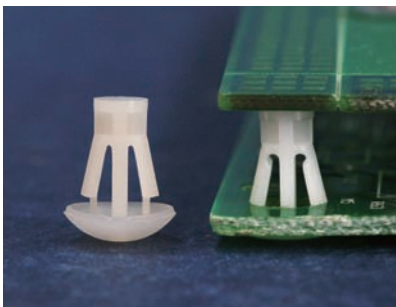

MOUNTING HOLE $\varnothing 4.8$
THICKNESS 0.8-1.2

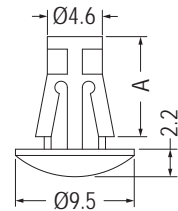

MOUNTING HOLE $\varnothing 4.8$
THICKNESS 0.8-1.2

Part No.	A	Package
RAD-3	3.0	1000
RAD-4	4.0	

Part No.	A	Package
RAD-6	6.3	1000
RAD-8	8.0	
RAD-10	10.0	
RAD-11	11.0	

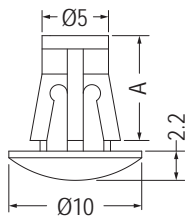

MOUNTING HOLE $\varnothing 5.5$
THICKNESS 0.8-1.6

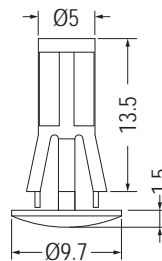

MOUNTING HOLE $\varnothing 5.5$
THICKNESS 1.2-1.8

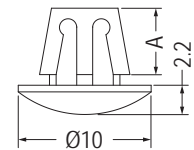

MOUNTING HOLE $\varnothing 5.5$
THICKNESS 0.8-1.6

Part No.	A	Package
RAM-6	6.35	1000
RAM-7	7.0	
RAM-8	8.0	
RAM-8.5	8.5	
RAM-10	10.0	
RAM-12A	12.0	
RAM-12	12.7	
RAM-13.5	13.5	
RAM-14	14.0	
RAM-15	15.2	
RAM-16	15.9	
RAM-18	18.0	
RAM-19	19.0	
RAM-20	20.0	500
RAM-22	21.7	
RAM-24	24.0	
RAM-25	25.4	
RAM-30	30.0	

Part No.	Package
RAM-13.5L	1000

Part No.	A	Package
RAM-3	3.5	1000
RAM-5	5.0	

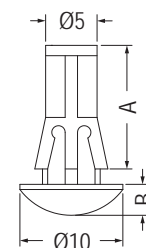

MOUNTING HOLE $\varnothing 5.5$
THICKNESS 1.6-2.5

Part No.	A	B	Package
RAML-11	11.0	3.0	1000
RAML-12	12.0	2.45	

PC板間隔柱 SPACER SUPPORT

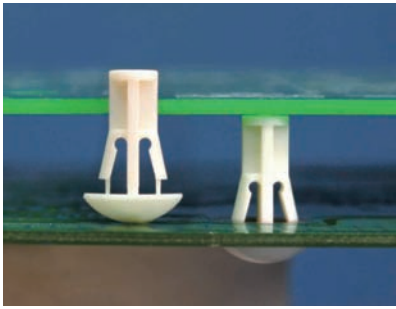

- Material: Nylon 66 (UL)
- Flame Class: 94V-2/94V-0
- Color: Natural/Black
- Unit: mm

用途：一端固定於機板上，另一端支撐PC板，避免下陷造成短路，PC板免鑽孔。

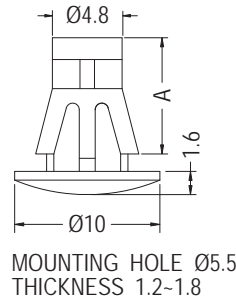

Part No.	A	Package
RAS-6	6.0	1000
RAS-8	8.0	
RAS-10	10.0	
RAS-12	12.0	
RAS-14	14.0	
RAS-18	18.0	
RAS-20	20.0	

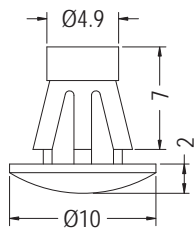

Part No.	Package
RAS-7	1000

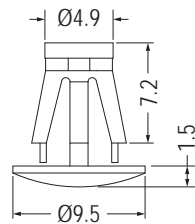

Part No.	Package
RAS-7.2	1000

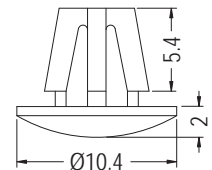

Part No.	Package
RAS-5	1000

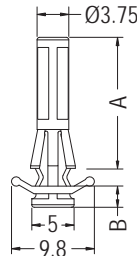
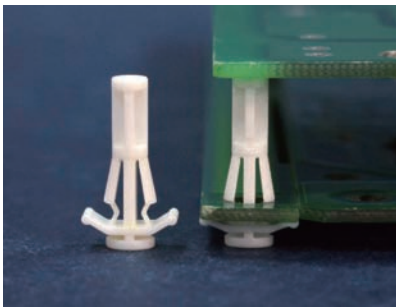

Part No.	A	B	Package
RAMC-12.5	12.5	2.5	1000
RAMC-15.5	15.5	2.5	
RAMC-18-4	18.0	4.0	
RAMC-18-8.5	18.0	8.5	
RAMC-19	19.0	2.5	
RAMC-24	24.0	2.5	

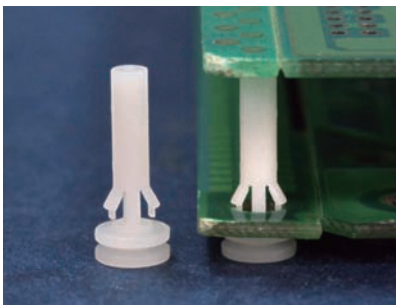

- Material: Nylon 66 (UL)
- Flame Class: 94V-2/94V-0
- Color: Natural/Black
- Unit: mm

用途：用於PCB之架高間隔，體積小，不佔空間。

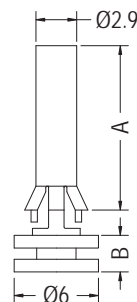

Part No.	A	B	Package
EDC-4	4.0	2.5	1000
EDC-5	5.0	2.5	
EDC-6	6.0	2.5	
EDC-7	7.0	2.5	
EDC-8	8.0	2.5	
EDC-9	9.0	2.5	
EDC-10	10.0	2.5	
EDC-11.4	11.4	2.5	
EDC-12.7	12.7	2.5	
EDC-13.5	13.5	2.5	
EDC-14.5	14.5	2.5	
EDC-15	15.0	2.5	
EDC-15-4	15.0	4.0	
EDC-15.9	15.9	2.5	

PC板間隔柱 SPACER SUPPORT

用途：一端固定於機板上，另一端支撐PC板，避免下陷造成短路，PC板免鑽孔。

1

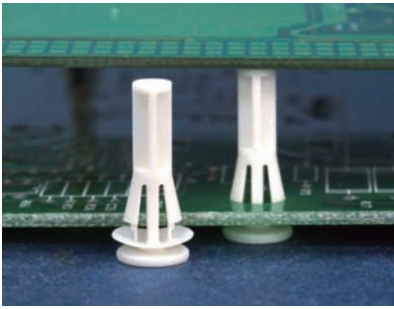

- Material: Nylon 66 (UL)
- Flame Class: 94V-2/94V-0
- Color: Natural/Black
- Unit: mm

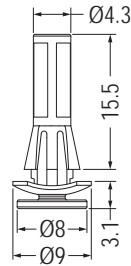

MOUNTING HOLE Ø4.8
THICKNESS 1.6

Part No.	Package
RAMD-15.5	1000

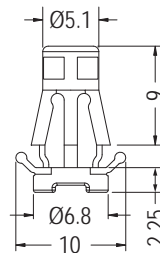
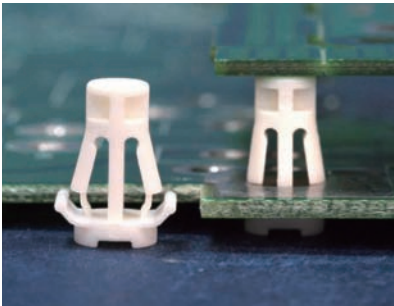

MOUNTING HOLE Ø5.6
THICKNESS 0.8-1.6

Part No.	Package
RAMB-9	1000

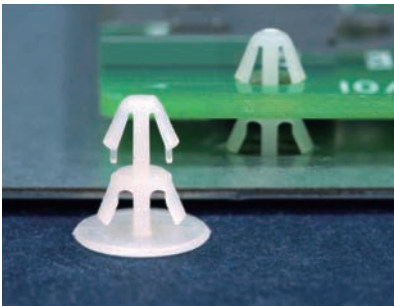

- Material: Nylon 66 (UL)
- Flame Class: 94V-2/94V-0
- Color: Natural/Black
- Unit: mm

用途：固定PC板於機板上，不會突出機板底部，外觀美麗。

MOUNTING HOLE Ø3.0
THICKNESS 1.6

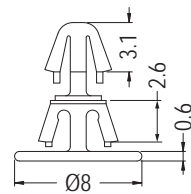

MOUNTING HOLE Ø4.0
THICKNESS 0.5

Part No.	Package
RCI-2.6	2000

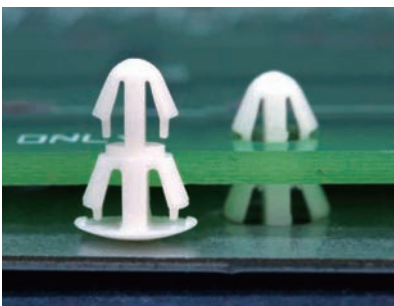

MOUNTING HOLE Ø3.0
THICKNESS 1.6

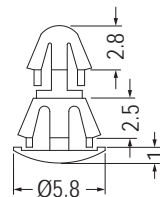

MOUNTING HOLE Ø4.0
THICKNESS 0.6-0.8

Part No.	Package
RCO-2.5	2000

MOUNTING HOLE Ø3.0
THICKNESS 1.6-2.0

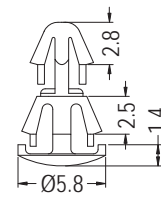

MOUNTING HOLE Ø4.0
THICKNESS 0.8-1.2

Part No.	Package
RCO-2.5L	2000

PC板間隔柱 SPACER SUPPORT

用途：固定PC板於機板上，不會突出機板底部，外觀美麗。

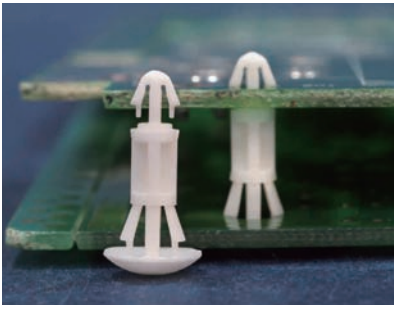

- Material: Nylon 66 (UL)
- Flame Class: 94V-2/94V-0
- Color: Natural/Black
- Unit: mm

MOUNTING HOLE Ø3.0
THICKNESS 1.6

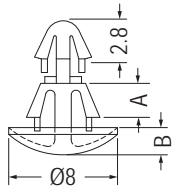

MOUNTING HOLE Ø4.0
THICKNESS 0.8-1.6

【 RCA-2.5, RCA-2.5U 】

MOUNTING HOLE Ø3.0
THICKNESS 1.6

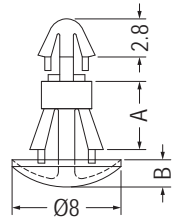

MOUNTING HOLE Ø4.0
THICKNESS 0.8-1.6

Part No.	A	B	Package
RCA-2.5U	2.5	1.8	2000
RCA-2.5	2.5	2.0	
RCA-3	3.2	2.0	
RCA-4	4.0	2.0	
RCA-4.5	4.5	2.0	
RCA-5	5.0	2.0	
RCA-5.5	5.5	2.0	

MOUNTING HOLE Ø3.0
THICKNESS: T

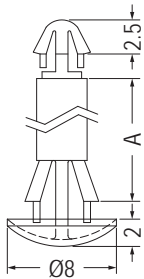

MOUNTING HOLE Ø4.0
THICKNESS 1.6-2.2

【 RCA-65.5 】

MOUNTING HOLE Ø3.0
THICKNESS: T

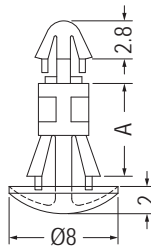

MOUNTING HOLE Ø4.0
THICKNESS 0.8-1.6

Part No.	A	T	Package
RCA-6	6.0	1.6	2000
RCA-6.4	6.4	1.6	
RCA-7	7.0	1.6	1000
RCA-7.5	7.5	1.6	
RCA-8	8.0	1.6	
RCA-8L	8.0	1.83	
RCA-9	9.0	1.6	
RCA-9.5	9.5	1.6	
RCA-10	10.0	1.6	
RCA-11.1	11.1	1.6	
RCA-12	12.0	1.6	
RCA-12.7	12.7	1.6	
RCA-14	14.0	1.6	
RCA-15.5	15.5	1.6	
RCA-16	16.0	1.6	
RCA-65.5	65.5	1.6	



MOUNTING HOLE Ø3.0
THICKNESS 1.6

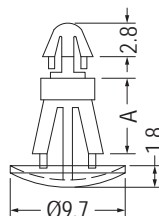

MOUNTING HOLE Ø4.8
THICKNESS 0.8-2.0

MOUNTING HOLE Ø3.0
THICKNESS 1.6

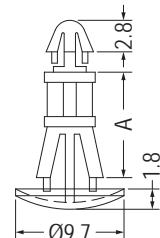

MOUNTING HOLE Ø4.8
THICKNESS 0.8-2.0

Part No.	A	Package
RCC-5	5.0	2000
RCC-6	6.3	
RCC-8	8.0	

Part No.	A	Package
RCC-10	10.0	1000
RCC-12	12.7	

PC板間隔柱 SPACER SUPPORT

用途：固定PC板於機板上，不會突出機板底部，外觀美麗。

1

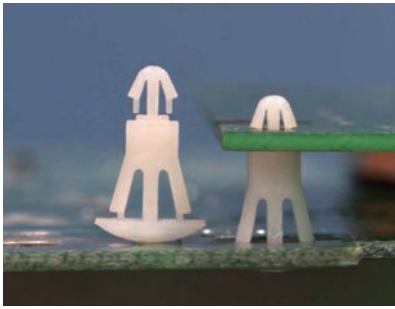

- Material: Nylon 66 (UL)
- Flame Class: 94V-2/94V-0
- Color: Natural/Black
- Unit: mm

MOUNTING HOLE Ø3.0
THICKNESS 1.2-1.7

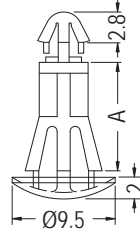

MOUNTING HOLE Ø5.5
THICKNESS 0.6-1.2

Part No.	A	Package
RCG-3.5	3.5	1000
RCG-5	4.8	
RCG-6.35	6.35	
RCG-7	7.0	
RCG-8	8.0	
RCG-10	10.0	
RCG-11	11.0	
RCG-12.7	12.7	
RCG-15.9	15.9	

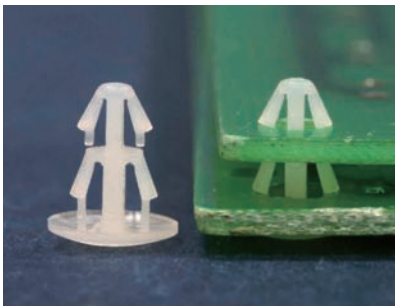

MOUNTING HOLE Ø3.2
THICKNESS 0.8-1.0

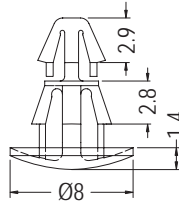

MOUNTING HOLE Ø4.0
THICKNESS 1.8

Part No.	Package
RCMB-2.8	1000

MOUNTING HOLE Ø3.2
THICKNESS 1.6

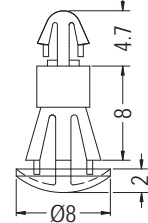

MOUNTING HOLE Ø4.8
THICKNESS 1.2-1.4

Part No.	Package
RCCA-8	1000

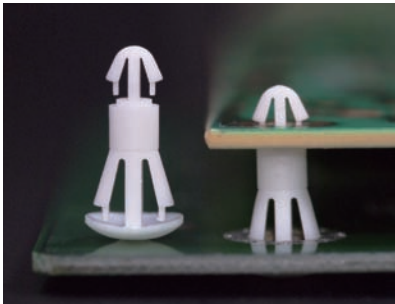

MOUNTING HOLE Ø3.5
THICKNESS 1.6

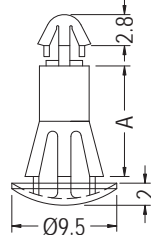

MOUNTING HOLE Ø5.5
THICKNESS 0.8-1.2

【 RCH-3.5-RCH-8 】

MOUNTING HOLE Ø3.5
THICKNESS 1.6

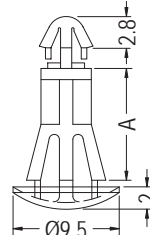

MOUNTING HOLE Ø5.5
THICKNESS 0.8-1.2

【 RCH-10-RCH-15.9 】

Part No.	A	Package
RCH-3.5	3.5	1000
RCH-5	4.8	
RCH-6.35	6.35	
RCH-7	7.0	
RCH-8	8.0	
RCH-10	10.0	
RCH-11	11.0	
RCH-12.7	12.7	
RCH-15.9	15.9	



MOUNTING HOLE Ø4.0
THICKNESS 1.2-1.6

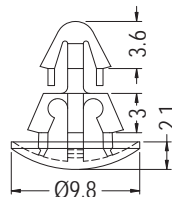

MOUNTING HOLE Ø5.5
THICKNESS 0.8-1.6

Part No.	Package
RCMA-3	1000

PC板間隔柱 SPACER SUPPORT

用途：固定PC板於機板上，不會突出機板底部，外觀美麗。

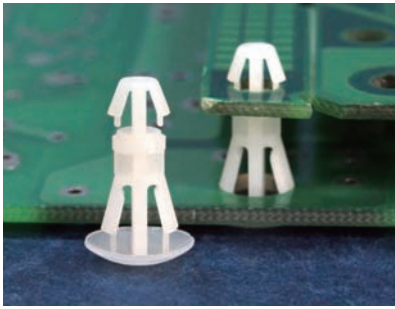

- Material: Nylon 66 (UL)
- Flame Class: 94V-2/94V-0
- Color: Natural/Black
- Unit: mm

MOUNTING HOLE Ø4.0
THICKNESS 1.7

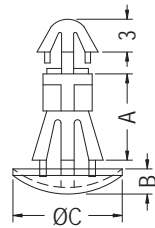

MOUNTING HOLE Ø5.0
THICKNESS 0.8-1.8

Part No.	A	B	C	Package
RCS-6	6.0	2.3	9.7	1000
RCS-13.8	13.8	2.2	10.0	
RCS-16	16.0	2.3	9.7	

MOUNTING HOLE Ø4.0
THICKNESS 1.0-1.8

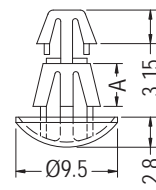

MOUNTING HOLE Ø4.8
THICKNESS 0.8-1.2

【 RCD-3, RCD-4 】

MOUNTING HOLE Ø4.0
THICKNESS 1.0-1.8

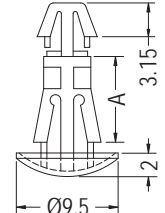

MOUNTING HOLE Ø4.8
THICKNESS 0.8-1.2

Part No.	A	Package
RCD-3	3.0	1000
RCD-4	4.0	
RCD-6	6.3	
RCD-8	8.0	
RCD-10	10.0	
RCD-11	11.0	

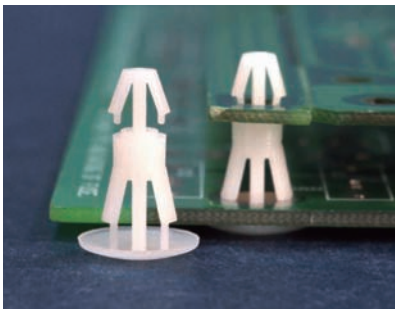

MOUNTING HOLE Ø4.0
THICKNESS 1.6

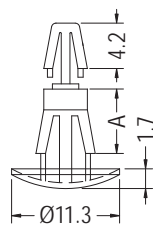

MOUNTING HOLE Ø5.5
THICKNESS 1.5-2.2

【 RCB-3-RCB-8 】

Part No.	A	Package
RCB-3	3.5	1000
RCB-5	5.0	
RCB-6	6.35	
RCB-8	8.0	
RCB-10	10.0	

MOUNTING HOLE Ø4.0
THICKNESS 1.6

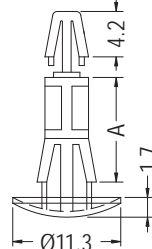

MOUNTING HOLE Ø5.5
THICKNESS 1.5-2.2

Part No.	A	Package
RCB-12	12.7	1000
RCB-15	15.9	
RCB-19	19.0	
RCB-25	25.4	500
RCB-35	35.5	

MOUNTING HOLE Ø4.0
THICKNESS 1.6

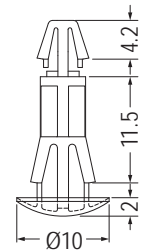

MOUNTING HOLE Ø5.5
THICKNESS 1.5-2.2

- Material: Nylon 46 (UL)
- Flame Class: 94V-2
- Color: Black

Part No.	Package
RCB-11.5	1000

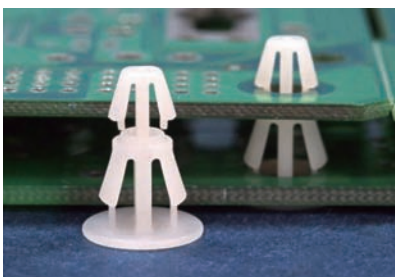

MOUNTING HOLE Ø4.0
THICKNESS 1.6

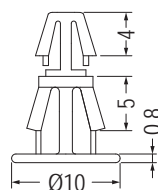

MOUNTING HOLE Ø5.5
THICKNESS 1.5-2.2

Part No.	Package
RCI-5	1000

MOUNTING HOLE Ø4.0
THICKNESS 1.6

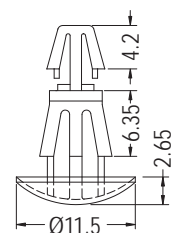

MOUNTING HOLE Ø5.5
THICKNESS 2.0-3.0

Part No.	Package
RCBL-6	1000

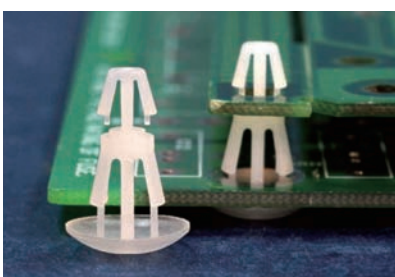

PC板間隔柱 SPACER SUPPORT

用途：固定PC板於機板上，不會突出機板底部，外觀美麗。

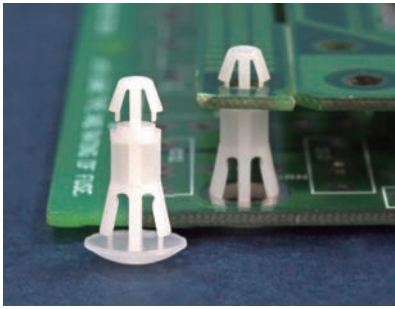

- Material: Nylon 66 (UL)
- Flame Class: 94V-2/94V-0
- Color: Natural/Black
- Unit: mm

MOUNTING HOLE Ø4.0
THICKNESS 1.2-1.7

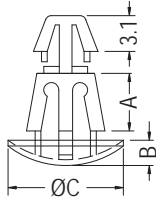

MOUNTING HOLE Ø5.5
THICKNESS 0.8-1.6

MOUNTING HOLE Ø4.0
THICKNESS 1.2-1.7

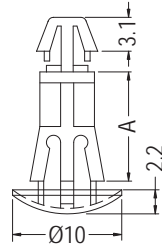

MOUNTING HOLE Ø5.5
THICKNESS: T

Part No.	A	B	C	Package
RCM-3	3.5	2.2	10.0	1000
RCM-5	5.0	2.2	10.0	
RCM-5SP	5.0	1.5	8.0	

Part No.	A	T	Package
RCM-6	6.35	0.8-1.6	1000
RCM-6L	6.35	1.6-2.0	
RCM-7	7.0	0.8-1.6	
RCM-8	8.0	0.8-1.6	
RCM-8.5	8.5	0.8-1.6	
RCM-10	10.0	0.8-1.6	
RCM-12A	12.0	0.8-1.6	
RCM-12	12.7	0.8-1.6	
RCM-13.5	13.5	0.8-1.6	
RCM-14	14.0	0.8-1.6	
RCM-15	15.2	0.8-1.6	
RCM-16	15.9	0.8-1.6	
RCM-18	18.0	0.8-1.6	
RCM-19	19.0	0.8-1.6	
RCM-20	20.0	0.8-1.6	
RCM-22	21.7	0.8-1.6	
RCM-24	24.0	0.8-1.6	
RCM-25	25.4	0.8-1.6	
RCM-30	30.0	0.8-1.6	

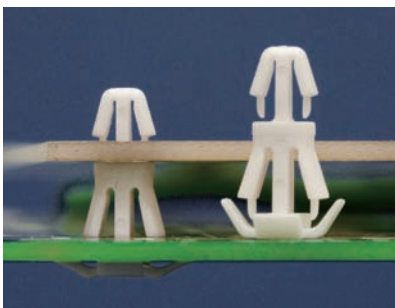

MOUNTING HOLE Ø4.0
THICKNESS 1.8

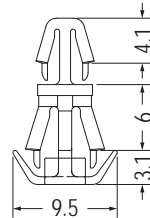

MOUNTING HOLE Ø5.5
THICKNESS 0.5-2.0

Part No.	Package
RCMD-6	1000

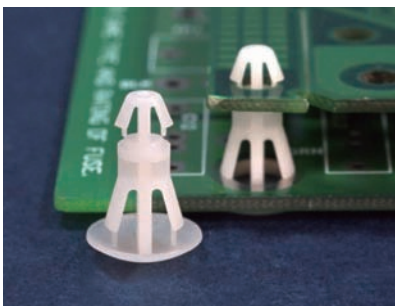

MOUNTING HOLE Ø4.0
THICKNESS 1.2-1.7

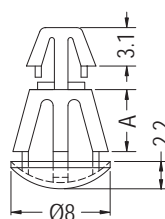

MOUNTING HOLE Ø6.0
THICKNESS 0.8-1.6

【RCF-5S】

MOUNTING HOLE Ø4.0
THICKNESS 1.2-1.7

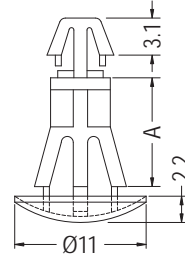

MOUNTING HOLE Ø6.0
THICKNESS 0.8-2.0

Part No.	A	Package
RCF-5	5.0	2000
RCF-5S	5.0	
RCF-6	6.35	1000
RCF-8	8.0	
RCF-10	10.0	
RCF-12	12.7	
RCF-15	15.9	

PC板間隔柱 SPACER SUPPORT

用途：固定PC板於機板上，不會突出機板底部，外觀美麗。

- Material: Nylon 66 (UL)
- Flame Class: 94V-2/94V-0
- Color: Natural/Black
- Unit: mm

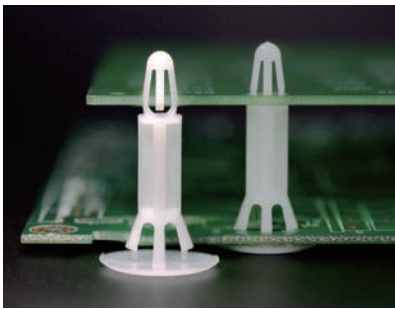
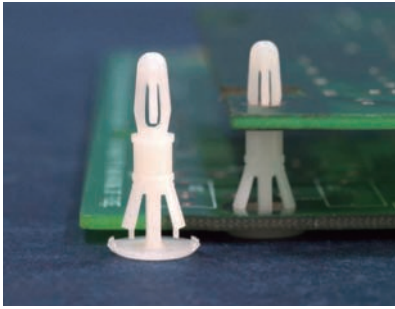
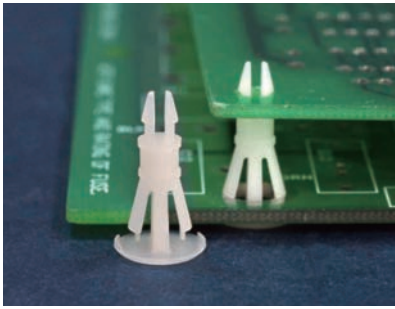

MOUNTING HOLE Ø3.2
THICKNESS 1.6

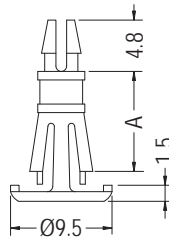

MOUNTING HOLE Ø4.8
THICKNESS 1.5-1.6

Part No.	A	Package
RCBS-6.5	6.5	1000
RCBS-9.5	9.5	
RCBS-12.7	12.7	

MOUNTING HOLE Ø6.2
THICKNESS 1.6

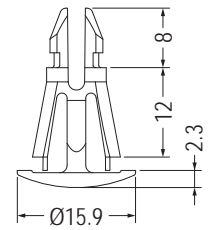

MOUNTING HOLE Ø9.0
THICKNESS 1.4

Part No.	Package
RCBC-12	1000

MOUNTING HOLE Ø3.2
THICKNESS 1.6

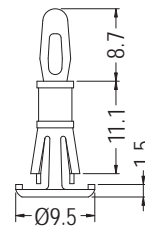

MOUNTING HOLE Ø4.8
THICKNESS 1.5-1.6

Part No.	Package
RCV-11.1	1000

MOUNTING HOLE Ø3.2
THICKNESS 1.7

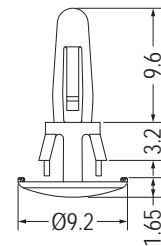

MOUNTING HOLE Ø4.8
THICKNESS 1.7

Part No.	Package
RCR-3.2	1000

MOUNTING HOLE Ø3.2
THICKNESS 1.2-1.7

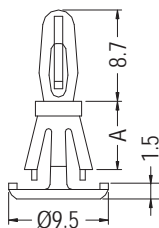

MOUNTING HOLE Ø4.8
THICKNESS 1.5-1.6

Part No.	A	Package
RCW-6.5	6.5	1000
RCW-7.9	7.9	
RCW-9.7	9.7	
RCW-11.1	11.1	
RCW-12.7	12.7	
RCW-14.3	14.3	
RCW-15.9	15.9	

MOUNTING HOLE Ø4.0
THICKNESS 1.6

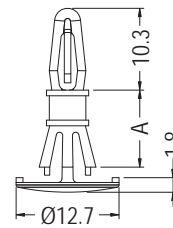

MOUNTING HOLE Ø5.4
THICKNESS 1.5-1.6

Part No.	A	Package
RCWA-6.4	6.4	1000
RCWA-9.5	9.5	
RCWA-12.7	12.7	
RCWA-15.9	15.9	
RCWA-19	19.1	
RCWA-22.2	22.2	
RCWA-25.4	25.4	

MOUNTING HOLE Ø5.3
THICKNESS 1.6

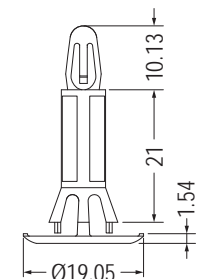

MOUNTING HOLE Ø9.0
THICKNESS 1.8

Part No.	Package
RCWB-21	1000

PC板間隔柱 SPACER SUPPORT

用途：固定PC板於機板上，不會突出機板底部，外觀美麗。

- Material: Nylon 66 (UL)
- Flame Class: 94V-2/94V-0
- Color: Natural/Black
- Unit: mm

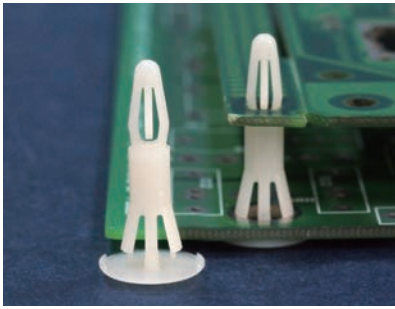

MOUNTING HOLE Ø4.0
THICKNESS 1.2-1.7

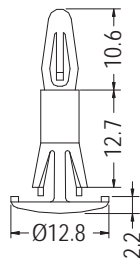

MOUNTING HOLE Ø5.5
THICKNESS 1.0-1.5

Part No.	Package
RCR-12.7	1000

MOUNTING HOLE Ø4.0
THICKNESS 1.2-1.6

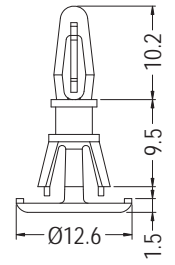

MOUNTING HOLE Ø6.35
THICKNESS 1.0-1.6

Part No.	Package
RCRA-9.5	1000

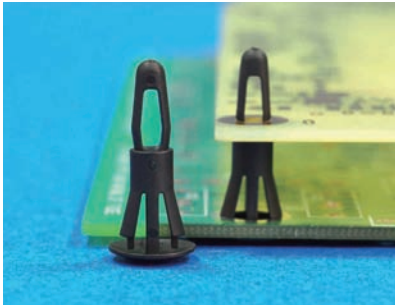

MOUNTING HOLE Ø4.0
THICKNESS 1.6

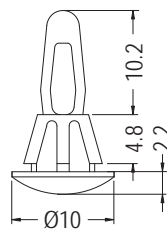

MOUNTING HOLE Ø6.0
THICKNESS 0.8-1.2

Part No.	Package
PCBTA-4.8	1000

MOUNTING HOLE Ø4.0
THICKNESS 1.6

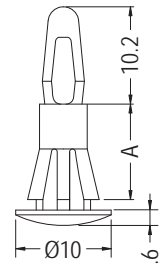

MOUNTING HOLE Ø5.5
THICKNESS 1.0-1.7

Part No.	A	Package
PCBT-4.8	4.8	1000
PCBT-10	10.0	

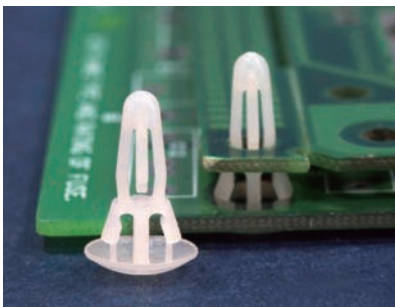

MOUNTING HOLE Ø4.0
THICKNESS 1.2-1.7

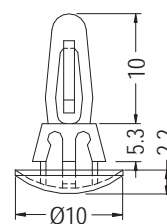

MOUNTING HOLE Ø5.5
THICKNESS 0.8-1.6

Part No.	Package
PCBS-3	1000

MOUNTING HOLE Ø4.0
THICKNESS 1.6

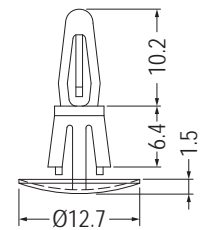

MOUNTING HOLE Ø5.4
THICKNESS 1.2-2.0

Part No.	Package
PCBS-6.4	1000

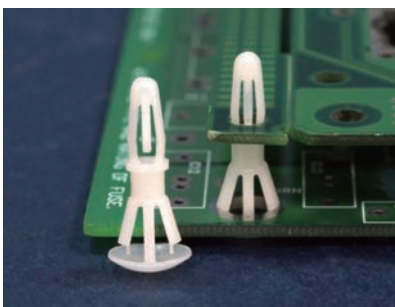

MOUNTING HOLE Ø4.0
THICKNESS 1.6

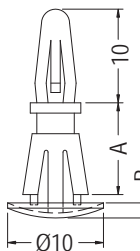

MOUNTING HOLE Ø5.5
THICKNESS 1.0-1.7

Part No.	A	B	Package
PCBS-6	6.3	1.6	1000
PCBS-8	7.9	2.1	
PCBS-10	10.0	2.1	
PCBS-12A	12.0	2.1	
PCBS-12	12.7	1.6	

PC板間隔柱 SPACER SUPPORT

用途：固定PC板於機板上，不會突出機板底部，外觀美麗。

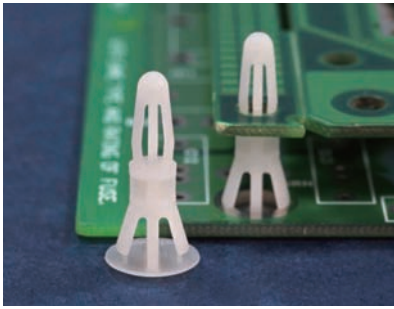

- Material: Nylon 66 (UL)
- Flame Class: 94V-2/94V-0
- Color: Natural/Black
- Unit: mm

MOUNTING HOLE Ø4.0
THICKNESS 1.6

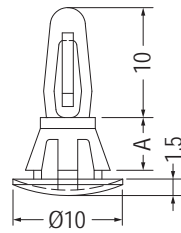

MOUNTING HOLE Ø6.0
THICKNESS 0.8-1.2

Part No.	A	Package
RCFL-4.8	4.8	1000
RCFL-6.4	6.4	

MOUNTING HOLE Ø4.0
THICKNESS 1.6

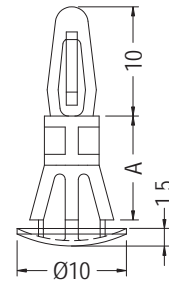

MOUNTING HOLE Ø6.0
THICKNESS 0.8-1.2

Part No.	A	Package
RCFL-8	8.0	1000
RCFL-9.5	9.5	
RCFL-12.7	12.7	
RCFL-15.9	15.9	
RCFL-19	19.0	

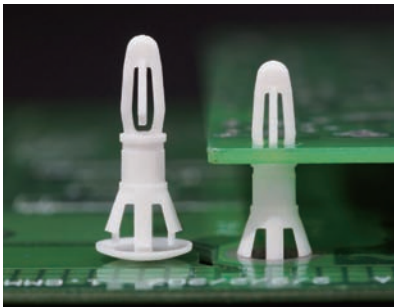

MOUNTING HOLE Ø4.0
THICKNESS 1.6

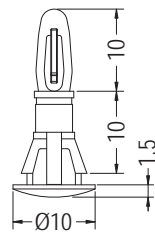

MOUNTING HOLE Ø6.5
THICKNESS 1.6-2.0

Part No.	Package
RCFB-10	1000

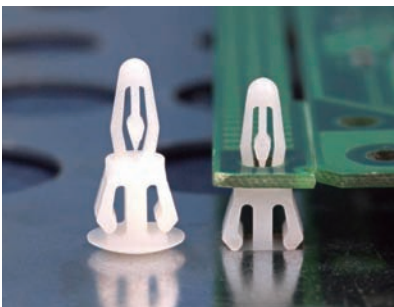

MOUNTING HOLE Ø4.0
THICKNESS 1.6

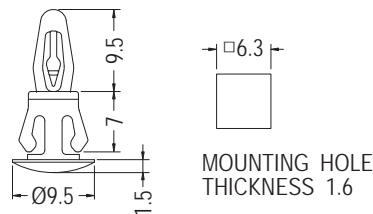

Part No.	Package
RCFA-7	1000

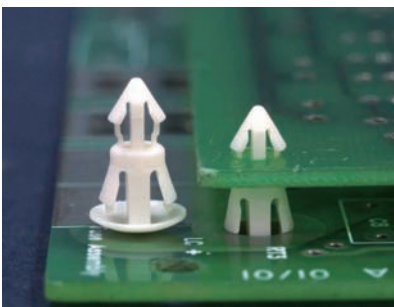

MOUNTING HOLE Ø3.5
THICKNESS 1.6-1.8

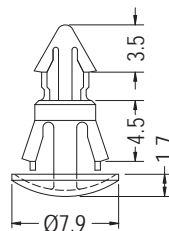

MOUNTING HOLE Ø5.5
THICKNESS 0.8

Part No.	Package
RCTA-4.5	1000

MOUNTING HOLE Ø3.5
THICKNESS 1.2-1.7

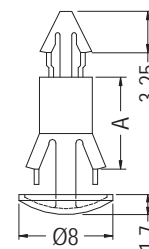

MOUNTING HOLE Ø4.8-Ø5.0
THICKNESS 1.2-1.7

Part No.	A	Package
RCT-4.5	4.5	1000
RCT-8	7.9	

PC板間隔柱 SPACER SUPPORT

用途：固定PC板於機板上，不會突出機板底部，外觀美麗。



- Material: Nylon 66 (UL)
- Flame Class: 94V-2/94V-0
- Color: Natural/Black
- Unit: mm

MOUNTING HOLE Ø4.0
THICKNESS 1.2-1.7

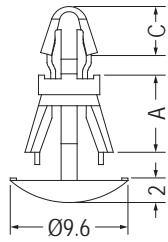

MOUNTING HOLE Ø5.4
THICKNESS 2.0

Part No.	A	C	Package
RCTL-6S	6.0	3.9	1000
RCTL-6	6.3	4.0	
RCTL-12	12.0	3.9	
RCTL-12	12.0	3.9	

MOUNTING HOLE Ø4.0
THICKNESS 1.6

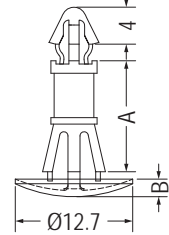

MOUNTING HOLE Ø5.4
THICKNESS 0.8-1.6

Part No.	A	B	Package
RCJ-8	8.0	2.1	1000
RCJ-10	10.0	1.7	
RCJ-12	12.0	1.7	
RCJ-12.7	12.7	1.7	

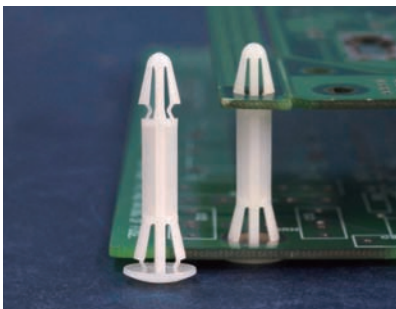

MOUNTING HOLE Ø4.0
THICKNESS 1.2-1.6

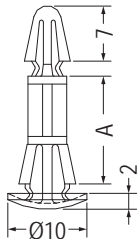

MOUNTING HOLE Ø5.5
THICKNESS 1.2-1.6

Part No.	A	Package
RBT-19	19.0	1000
RBT-28.2	28.2	

MOUNTING HOLE Ø4.0
THICKNESS 3.0

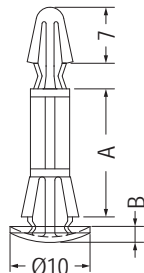

MOUNTING HOLE Ø5.5
THICKNESS 1.2-1.6

Part No.	A	B	Package
RBT-16L	16.0	1.8	1000
RBT-25L	25.0	2.0	

MOUNTING HOLE Ø4.0
THICKNESS 1.2-1.7

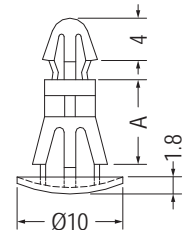

MOUNTING HOLE Ø5.5
THICKNESS 1.2-1.8

Part No.	A	Package
RBS-5	5.0	1000
RBS-6	6.0	
RBS-7	7.0	
RBS-8	8.0	
RBS-10	10.0	
RBS-11	11.0	
RBS-12	12.0	
RBS-14	14.0	
RBS-18	18.0	
RBS-20	20.0	
RBS-23	23.0	

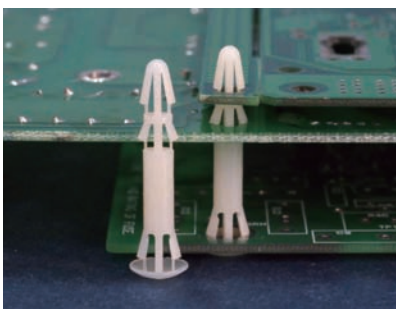

- Material: Nylon 66 (UL)
- Flame Class: 94V-2/94V-0
- Color: Natural/Black
- Unit: mm

用途：用於三層PC板，與機板間之固定，方便、節省空間。

MOUNTING HOLE Ø4.0
THICKNESS 1.6

MOUNTING HOLE Ø4.5
THICKNESS 1.6

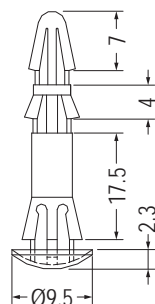

MOUNTING HOLE Ø5.0
THICKNESS 1.6

Part No.	Package
DRCB-18	1000

PC板間隔柱 SPACER SUPPORT

用途：固定PC板於機板上，不會突出機板底部，外觀美麗。

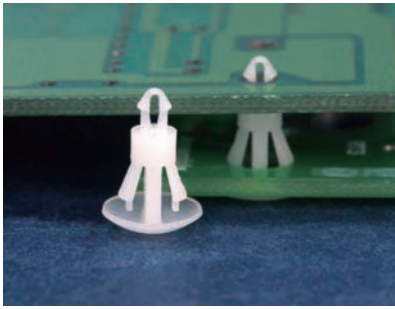

- Material: Nylon 66 (UL)
- Flame Class: 94V-2/94V-0
- Color: Natural/Black
- Unit: mm

MOUNTING HOLE Ø2.0
THICKNESS 1.6

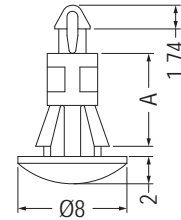

MOUNTING HOLE Ø2.0
THICKNESS 1.6

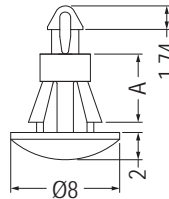

MOUNTING HOLE Ø4.0
THICKNESS 0.8-1.6

Part No.	A	Package
RCAB-6	6.0	1000
RCAB-6.4	6.4	
RCAB-7	7.0	
RCAB-7.5	7.5	
RCAB-8	8.0	
RCAB-9	9.0	
RCAB-9.5	9.5	
RCAB-10	10.0	
RCAB-11.1	11.1	
RCAB-12	12.0	
RCAB-12.7	12.7	
RCAB-14	14.0	
RCAB-16	16.0	

MOUNTING HOLE Ø2.0
THICKNESS 1.0

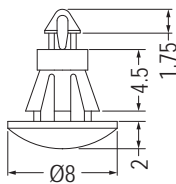

MOUNTING HOLE Ø4.0
THICKNESS 0.8-1.6

Part No.	A	Package
RCAB-3	3.2	1000
RCAB-4	4.0	
RCAB-4.5	4.5	
RCAB-5	5.0	
RCAB-5.5	5.5	

MOUNTING HOLE Ø4.0
THICKNESS 0.8-1.6

Part No.	Package
RCAB-4.5S	1000

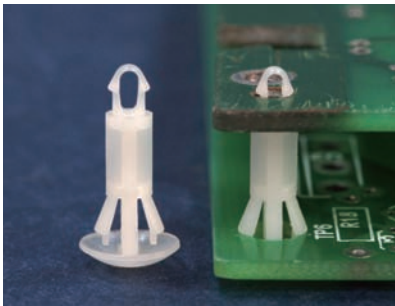

MOUNTING HOLE Ø2.5
THICKNESS 1.6

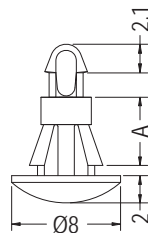

MOUNTING HOLE Ø2.5
THICKNESS 1.6

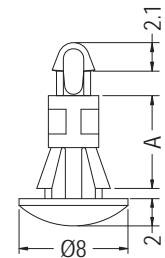

MOUNTING HOLE Ø4.0
THICKNESS 0.8-1.6

Part No.	A	Package
RCAC-3	3.0	1000
RCAC-4	4.0	
RCAC-4.5	4.5	
RCAC-5	5.0	
RCAC-5.5	5.5	

MOUNTING HOLE Ø4.0
THICKNESS 0.8-1.6

Part No.	A	Package
RCAC-6	6.0	1000
RCAC-6.4	6.4	
RCAC-7	7.0	
RCAC-7.5	7.5	
RCAC-8	8.0	
RCAC-9	9.0	
RCAC-9.5	9.5	
RCAC-10	10.0	
RCAC-11.1	11.1	
RCAC-12	12.0	
RCAC-12.7	12.7	
RCAC-14	14.0	
RCAC-16	16.0	

PC板間隔柱 SPACER SUPPORT

用途：PC板與PC板間之固定，不佔空間。

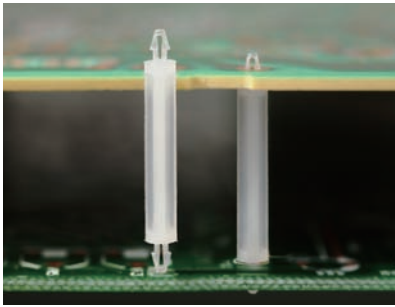

- Material: Nylon 66 (UL)
- Flame Class: 94V-2/94V-0
- Color: Natural/Black
- Unit: mm

MOUNTING HOLE Ø1.5
THICKNESS 1.0

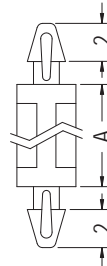

MOUNTING HOLE Ø1.5
THICKNESS 1.0

Part No.	A	Package
MASSD-14	14.0	2000
MASSD-18	18.0	1000

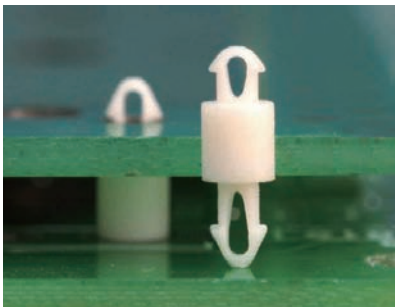

MOUNTING HOLE Ø1.6
THICKNESS 1.0

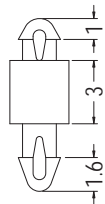

MOUNTING HOLE Ø1.6
THICKNESS 1.6

Part No.	Package
MADSA-3	1000

MOUNTING HOLE Ø1.6
THICKNESS 1.0

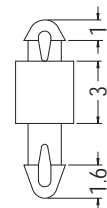

MOUNTING HOLE Ø1.6
THICKNESS 2.0

Part No.	Package
MADSB-3	2000

MOUNTING HOLE Ø1.6
THICKNESS 0.7

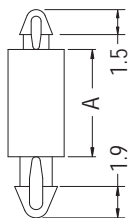

MOUNTING HOLE Ø2.0
THICKNESS 1.6

Part No.	A	Package
MADS-6.5	6.5	2000
MADS-19.2	19.2	1000

MOUNTING HOLE Ø1.6
THICKNESS 1.5

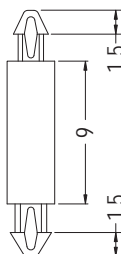

MOUNTING HOLE Ø2.0
THICKNESS 1.6

Part No.	Package
MAS-9	1000

MOUNTING HOLE Ø1.7
THICKNESS 1.7

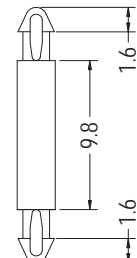

MOUNTING HOLE Ø1.7
THICKNESS 1.7

Part No.	Package
MAD1.7-9.8	1000

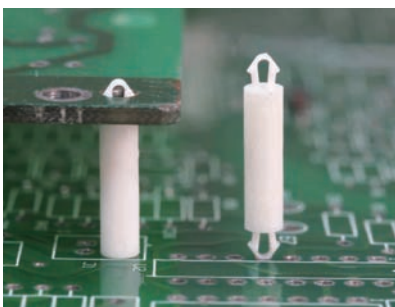

MOUNTING HOLE Ø2.0
THICKNESS 1.0

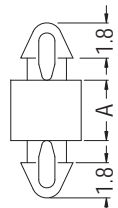

MOUNTING HOLE Ø2.0
THICKNESS 1.0

Part No.	A	Package
MAD1-3	3.0	2000
MAD1-19	19.0	1000

MOUNTING HOLE Ø2.0
THICKNESS 1.0-1.2

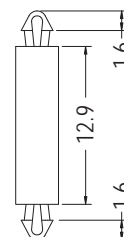

MOUNTING HOLE Ø2.0
THICKNESS 1.0-1.2

Part No.	Package
MAD1.2-12.9	1000

PC板間隔柱 SPACER SUPPORT

用途：PC板與PC板間之固定，不佔空間。

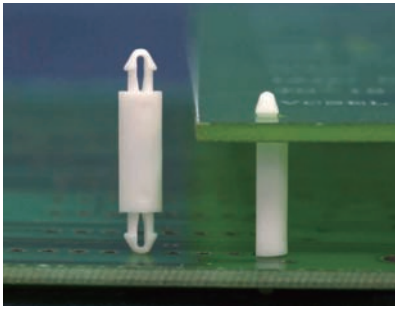

- Material: Nylon 66 (UL)
- Flame Class: 94V-2/94V-0
- Color: Natural/Black
- Unit: mm

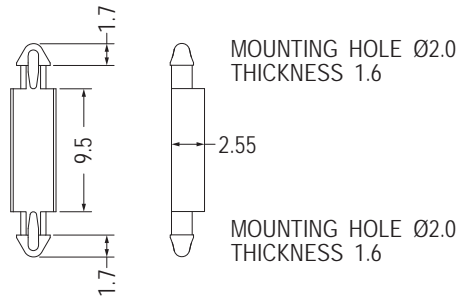

Part No.	Package
MADX-9.5	1000

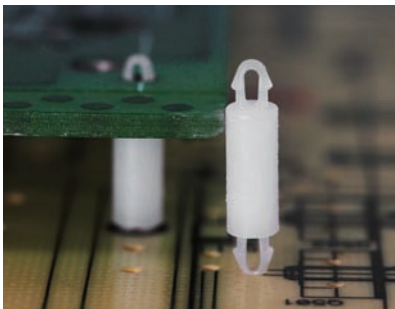

MOUNTING HOLE Ø2.0
THICKNESS 1.2

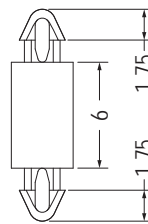

MOUNTING HOLE Ø2.0
THICKNESS 1.2

Part No.	Package
MAD1.2-6	1000

MOUNTING HOLE Ø2.0
THICKNESS 1.2

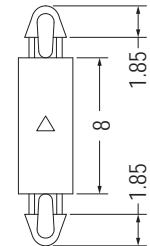

MOUNTING HOLE Ø2.0
THICKNESS 1.2

Part No.	Package
MAD1.2-8	1000

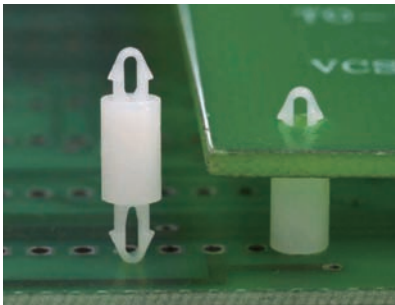

MOUNTING HOLE Ø2.0
THICKNESS 1.6

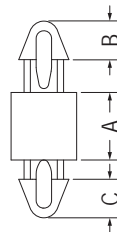

MOUNTING HOLE Ø2.0
THICKNESS: T

Part No.	A	B	C	T	Package
MADB-3.5	3.5	2.0	2.0	0.9	2000
MADB-6	6.0	1.9	1.9	0.8	

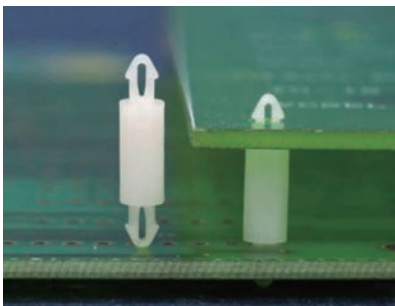

MOUNTING HOLE Ø2.0
THICKNESS 1.6

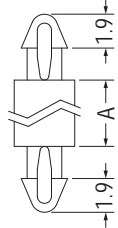

MOUNTING HOLE Ø2.0
THICKNESS 1.6

【 MAD-14 】

MOUNTING HOLE Ø2.0
THICKNESS 1.6

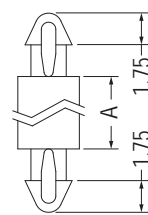

MOUNTING HOLE Ø2.0
THICKNESS 1.6

Part No.	A	Package
MAD-1.6	1.6	2000
MAD-2.2	2.2	
MAD-3	3.0	
MAD-3.5	3.5	
MAD-4	4.0	
MAD-5	5.0	
MAD-6	6.0	
MAD-6.5	6.5	
MAD-7	7.0	
MAD-8	8.0	
MAD-10S	10.0	
MAD-10	10.5	
MAD-12.5	12.5	
MAD-14	14.0	
MAD-25	25.0	

PC板間隔柱 SPACER SUPPORT

用途：PC板與PC板間之固定，不佔空間。

1

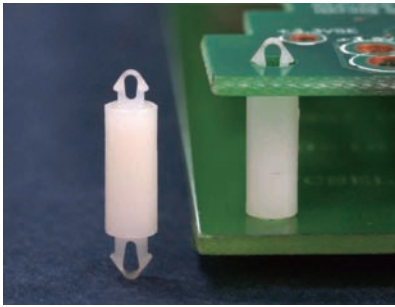

- Material: Nylon 66 (UL)
- Flame Class: 94V-2/94V-0
- Color: Natural/Black
- Unit: mm

MOUNTING HOLE $\varnothing 2.0$
THICKNESS 1.0

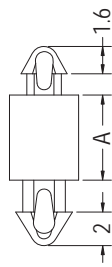

MOUNTING HOLE $\varnothing 2.5$
THICKNESS 1.6

Part No.	A	Package
MAMDA-1.6	1.6	1000
MAMDA-2.5	2.5	
MAMDA-3.2	3.2	
MAMDA-4	4.0	
MAMDA-4.8	4.8	
MAMDA-5.5	5.5	
MAMDA-6.4	6.4	
MAMDA-7	7.0	
MAMDA-7.9	7.9	
MAMDA-9.5	9.5	
MAMDA-10	10.0	
MAMDA-12.7	12.7	

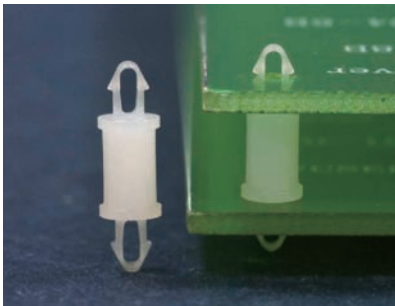

MOUNTING HOLE $\varnothing 2.2$
THICKNESS 1.6

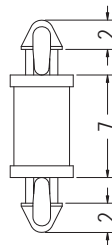

MOUNTING HOLE $\varnothing 2.2$
THICKNESS 1.6

Part No.	Package
MAHA-7	1000

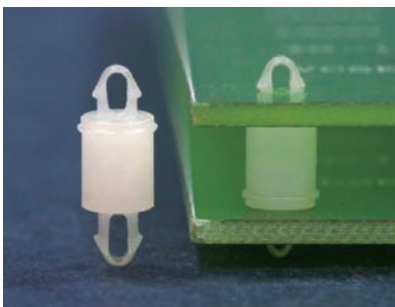

MOUNTING HOLE $\varnothing 2.5$
THICKNESS 1.0

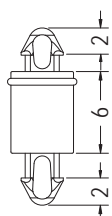

MOUNTING HOLE $\varnothing 2.5$
THICKNESS 1.6

Part No.	Package
MADJ-6	2000

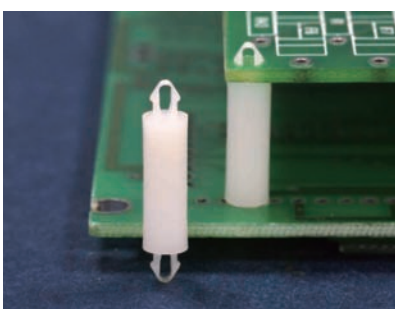

MOUNTING HOLE $\varnothing 2.5$
THICKNESS 0.6

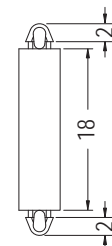

MOUNTING HOLE $\varnothing 2.5$
THICKNESS 0.6

Part No.	Package
MADA-18S	2000

MOUNTING HOLE $\varnothing 2.5$
THICKNESS 1.6

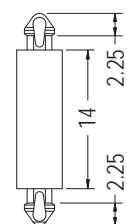

MOUNTING HOLE $\varnothing 2.5$
THICKNESS 1.6

Part No.	Package
MADAA-14	1000

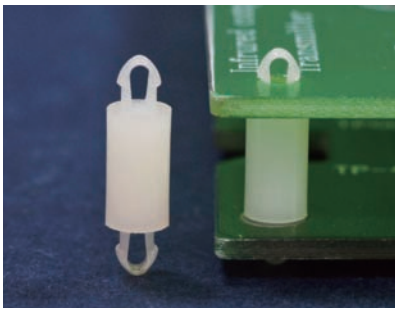

- Material: Nylon 66 (UL)
- Flame Class: 94V-2/94V-0
- Color: Natural/Black
- Unit: mm

MOUNTING HOLE Ø2.5
THICKNESS 1.6

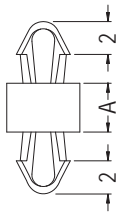

MOUNTING HOLE Ø2.5
THICKNESS 1.6

【 MADA-3-1 】

MOUNTING HOLE Ø2.5
THICKNESS 1.6

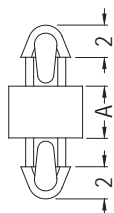

MOUNTING HOLE Ø2.5
THICKNESS 1.6

Part No.	A	Package
MADA-2	2.0	2000
MADA-3	3.0	
MADA-3-1	3.0	
MADA-3.5	3.5	
MADA-4	4.0	
MADA-5	5.0	
MADA-6	6.0	
MADA-6.7	6.7	
MADA-7	7.0	
MADA-8	8.0	
MADA-8.5	8.5	

Part No.	A	Package
MADA-9	9.0	2000
MADA-10	10.0	
MADA-11	11.0	
MADA-12	12.0	
MADA-12.7	12.7	
MADA-14	14.0	
MADA-16	16.0	
MADA-18	18.0	
MADA-20	20.0	
MADA-22	22.0	

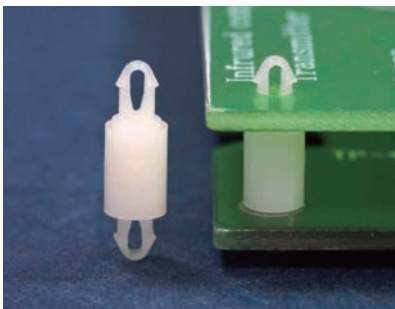

MOUNTING HOLE Ø2.5
THICKNESS 2.2

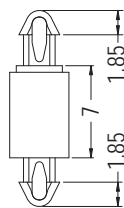

MOUNTING HOLE Ø2.5
THICKNESS 2.0

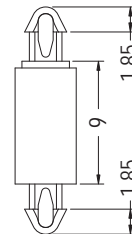

MOUNTING HOLE Ø2.5
THICKNESS 1.6

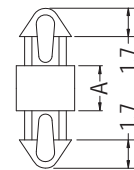

MOUNTING HOLE Ø2.5
THICKNESS 1.6

MOUNTING HOLE Ø2.5
THICKNESS 1.7

Part No.	Package
MAMDF-7	1000

MOUNTING HOLE Ø2.5
THICKNESS 1.2-1.7

Part No.	Package
MAMDL-9	1000

Part No.	A	Package
MADM-2.7S	2.7	2000
MADM-3S	3.0	

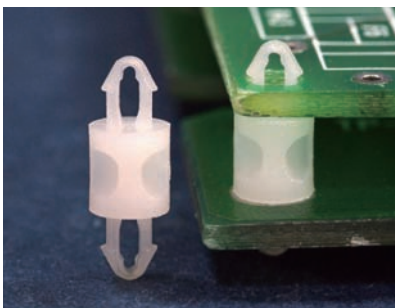

MOUNTING HOLE Ø2.5
THICKNESS 1.6

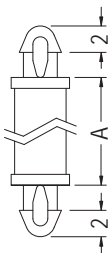

MOUNTING HOLE Ø2.5
THICKNESS 1.6

Part No.	Package
MADM-12.7	2000

MOUNTING HOLE Ø2.5
THICKNESS 1.6

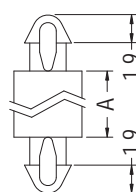

MOUNTING HOLE Ø2.5
THICKNESS 1.6

【 MADM-2-MADM-5 】

MOUNTING HOLE Ø2.5
THICKNESS 1.6

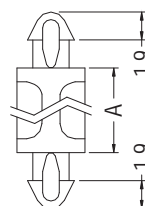

MOUNTING HOLE Ø2.5
THICKNESS 1.6

Part No.	A	Package
MADM-2	2.0	2000
MADM-3	3.0	
MADM-4	4.0	
MADM-4.5	4.5	
MADM-5	5.0	
MADM-6	6.0	
MADM-6.5	6.5	
MADM-7.5	7.5	
MADM-8	8.0	
MADM-9.5	9.5	
MADM-10A	10.0	
MADM-10	10.5	
MADM-27	27.0	

PC板間隔柱 SPACER SUPPORT

用途：PC板與PC板間之固定，不佔空間。

1

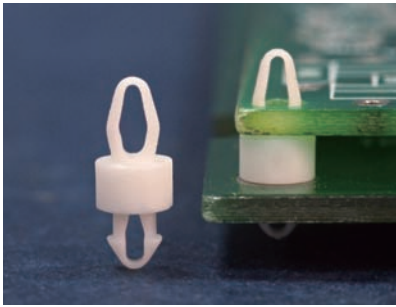

- Material: Nylon 66 (UL)
- Flame Class: 94V-2/94V-0
- Color: Natural/Black
- Unit: mm

MOUNTING HOLE $\varnothing 2.5$
THICKNESS 1.0

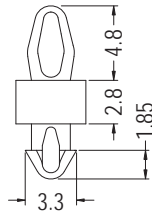

MOUNTING HOLE $\varnothing 2.5$
THICKNESS 1.6

Part No.	Package
MADE-2.8	1000

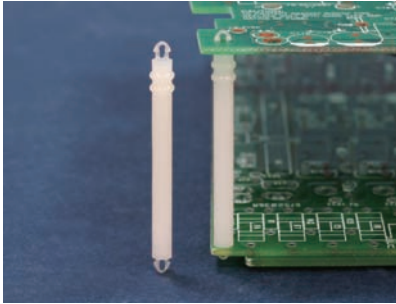

MOUNTING HOLE $\varnothing 2.5$
THICKNESS 1.6

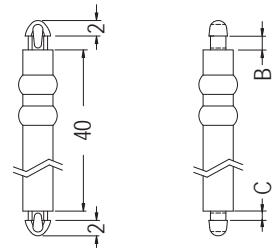

MOUNTING HOLE $\varnothing 2.5$
THICKNESS 1.0

Part No.	B	C	Package
MAC-40	1.8	1.2	500
MAC-40S	1.5	1.0	

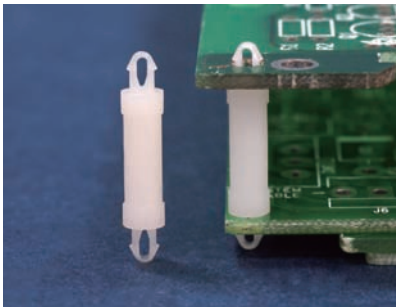

MOUNTING HOLE $\varnothing 2.5$
THICKNESS 2.0

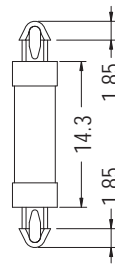

MOUNTING HOLE $\varnothing 2.5$
THICKNESS 2.0

Part No.	Package
MAHC-14.3	1000

MOUNTING HOLE $\varnothing 2.6$
THICKNESS 1.6

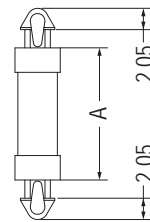

MOUNTING HOLE $\varnothing 2.6$
THICKNESS 1.6

Part No.	A	Package
MAHC-6.4S	6.4	1000
MAHC-9.5S	9.5	
MAHC-12.7S	12.7	
MAHC-15.9S	15.9	

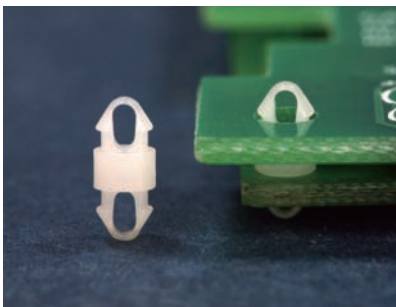

MOUNTING HOLE $\varnothing 2.6$
THICKNESS 1.0

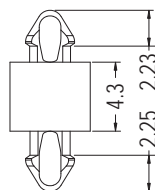

MOUNTING HOLE $\varnothing 2.5$
THICKNESS 1.6

Part No.	Package
MADAB-4.3	1000

MOUNTING HOLE $\varnothing 2.6$
THICKNESS 1.0

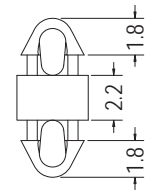

MOUNTING HOLE $\varnothing 2.6$
THICKNESS 1.0

Part No.	Package
MADM1-2.2	2000

PC板間隔柱 SPACER SUPPORT

用途：PC板與PC板間之固定，不佔空間。

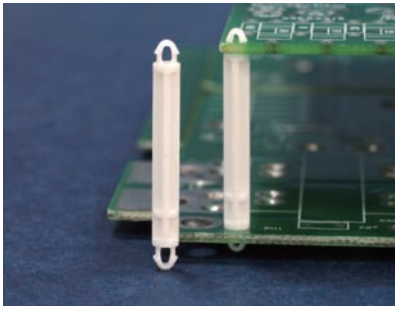

- Material: Nylon 66 (UL)
- Flame Class: 94V-2/94V-0
- Color: Natural/Black
- Unit: mm

MOUNTING HOLE Ø3.0
THICKNESS 1.2

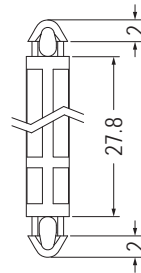

MOUNTING HOLE Ø3.0
THICKNESS 1.6

Part No.	Package
MADL-27.8	1000

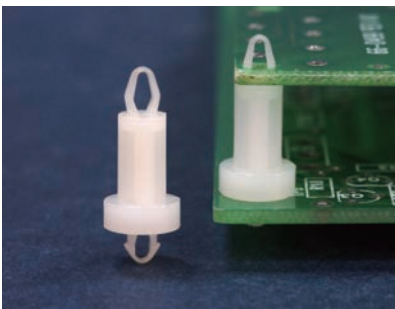

MOUNTING HOLE Ø3.0
THICKNESS 1.2

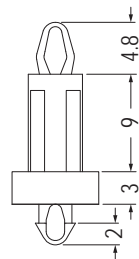

MOUNTING HOLE Ø3.0
THICKNESS 1.6

Part No.	Package
MAMDC-12	1000

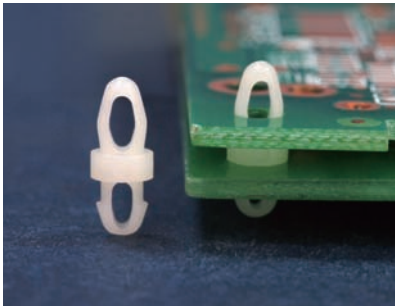

MOUNTING HOLE Ø3.1
THICKNESS 1.4-1.6

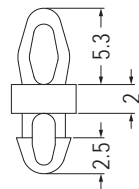

MOUNTING HOLE Ø3.0
THICKNESS 1.45-1.6

Part No.	Package
MADD-2	1000

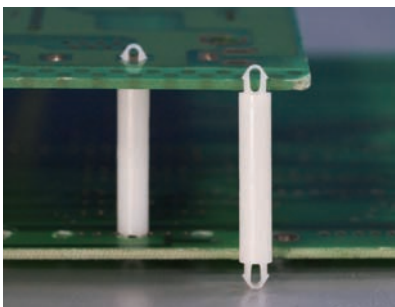

MOUNTING HOLE Ø3.2
THICKNESS 1.6

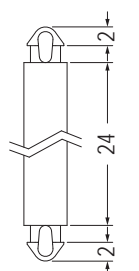

MOUNTING HOLE Ø3.2
THICKNESS 1.6

Part No.	Package
MADN-24	1000

PC板間隔柱 SPACER SUPPORT

用途：PC板與PC板間之固定，不佔空間。

1

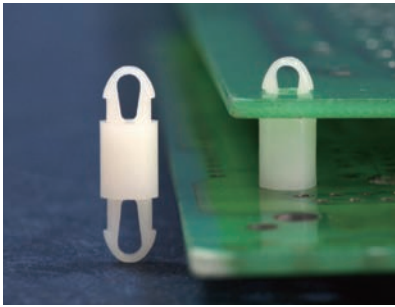

- Material: Nylon 66 (UL)
- Flame Class: 94V-2/94V-0
- Color: Natural/Black
- Unit: mm

MOUNTING HOLE $\varnothing 3.5$
THICKNESS 1.6

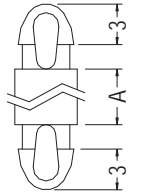

MOUNTING HOLE $\varnothing 3.5$
THICKNESS 1.6

Part No.	A	Package
MAF-2	2.0	1000
MAF-3	3.0	
MAF-4	4.0	
MAF-5	5.0	
MAF-6	6.0	
MAF-7	7.0	
MAF-8	8.0	

Part No.	A	Package
MAF-10	10.0	1000
MAF-11	11.0	
MAF-12	12.0	
MAF-14	14.0	
MAF-16	16.0	
MAF-18	18.0	
MAF-20	20.0	
MAF-22	22.0	

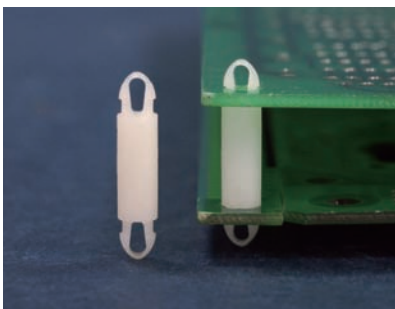

MOUNTING HOLE $\varnothing 3.5$
THICKNESS 1.6

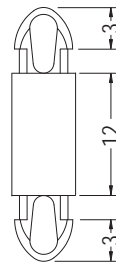

MOUNTING HOLE $\varnothing 3.5$
THICKNESS 1.6

Part No.	Package
MAD3.5-12	1000

MOUNTING HOLE $\varnothing 3.5$
THICKNESS 2.1

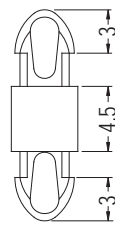

MOUNTING HOLE $\varnothing 3.5$
THICKNESS 1.6

Part No.	Package
MDLS-4.5	1000

MOUNTING HOLE $\varnothing 3.5$
THICKNESS 1.6

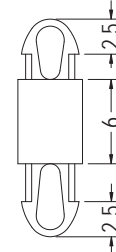

MOUNTING HOLE $\varnothing 3.5$
THICKNESS 2.5

Part No.	Package
MAFA-6	1000

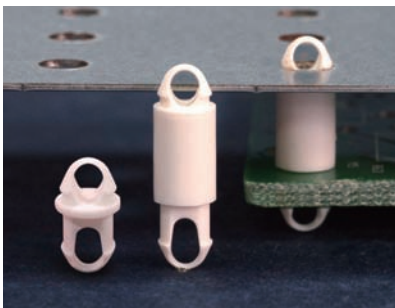

MOUNTING HOLE $\varnothing 5.0$
THICKNESS 0.8

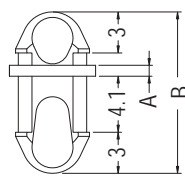

MOUNTING HOLE $\varnothing 5.0$
THICKNESS 4.0

Part No.	A	B	Package
MAFB5-0.8	0.8	11.8	500
MAFB5-9.7	9.7	20.7	

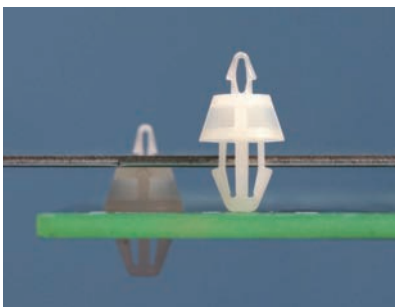

MOUNTING HOLE $\varnothing 1.5$
THICKNESS 0.8

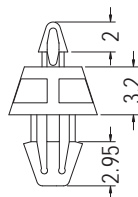

MOUNTING HOLE $\varnothing 3.0$
THICKNESS 1.6

Part No.	Package
MAEB-3.2	1000

MOUNTING HOLE $\varnothing 2.5$
THICKNESS 1.0

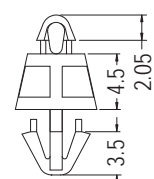

MOUNTING HOLE $\varnothing 4.0$
THICKNESS 1.6

Part No.	Package
MAEE-4.5	1000

PC板間隔柱 SPACER SUPPORT

用途：PC板與PC板間之固定，不佔空間。

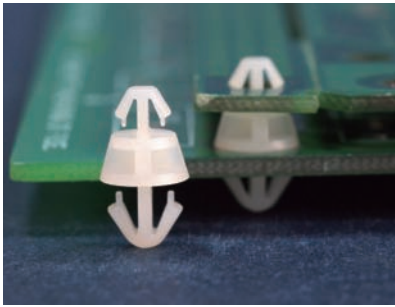

- Material: Nylon 66 (UL)
- Flame Class: 94V-2/94V-0
- Color: Natural/Black
- Unit: mm

MOUNTING HOLE Ø3.0
THICKNESS 1.0

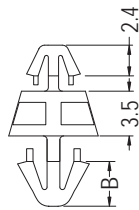

MOUNTING HOLE Ø3.0
THICKNESS 1.0

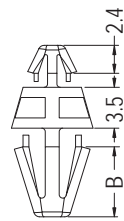

MOUNTING HOLE Ø4.0
THICKNESS: T

【 MAEA-3.5M 】

MOUNTING HOLE Ø4.8
THICKNESS: T

Part No.	B	T	Package
MAEA-3.5M	3.5	1.6	1000
MAEA-3.5	6.0	1.2	
MAEA-3.5L	6.0	1.6	
MAEA-3.5LS	4.1	1.6	

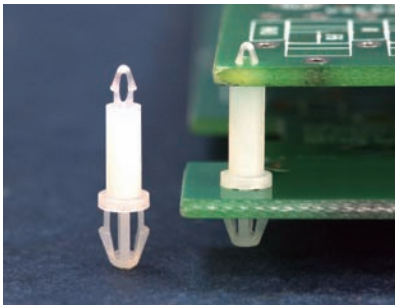

MOUNTING HOLE Ø1.5
THICKNESS 1.0

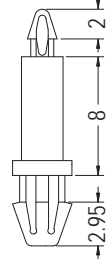

MOUNTING HOLE Ø3.0
THICKNESS 1.6

Part No.	Package
LCMB-8	1000

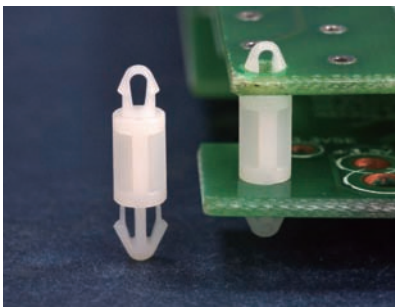

MOUNTING HOLE Ø2.5
THICKNESS 1.6

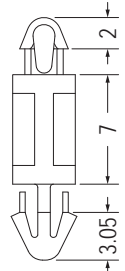

MOUNTING HOLE Ø3.0
THICKNESS 1.6

Part No.	Package
LCMC-7	1000

MOUNTING HOLE Ø3.5
THICKNESS 2.4

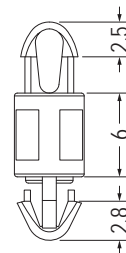

MOUNTING HOLE Ø3.5
THICKNESS 1.6

Part No.	Package
MAMDD-6	1000

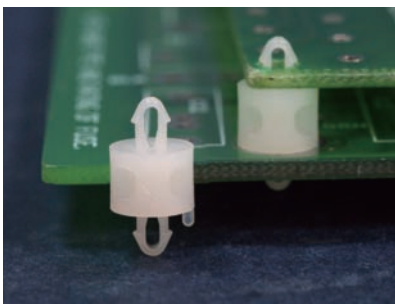

MOUNTING HOLE Ø2.5
THICKNESS 1.6

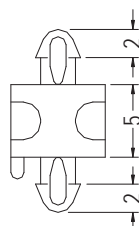

MOUNTING HOLE Ø2.5
THICKNESS 1.6

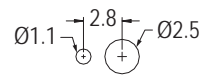

MOUNTING HOLE

Part No.	Package
MADMK-5	2000

PC板間隔柱 SPACER SUPPORT

用途：PC板與PC板間之固定，不佔空間。

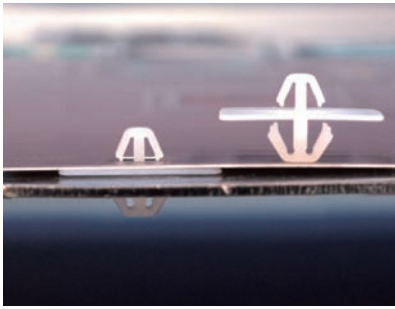

- Material: Nylon 66 (UL)
- Flame Class: 94V-2/94V-0
- Color: Natural/Black
- Unit: mm

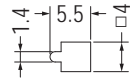

MOUNTING HOLE THICKNESS: T

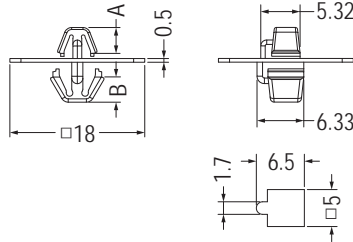

MOUNTING HOLE THICKNESS 1.0-1.5

Part No.	A	B	T	Package
KVD-05	3.5	3.4	0.5	500
KVD-10	3.6	3.5	1.0	

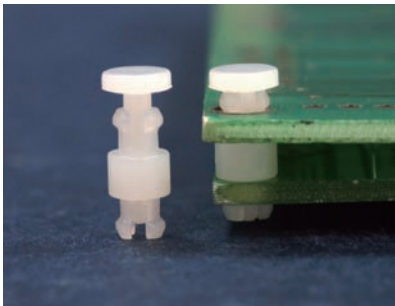

MOUNTING HOLE Ø3.0 THICKNESS 1.1

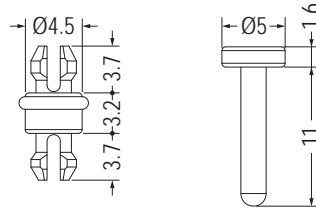

MOUNTING HOLE Ø3.0 THICKNESS 1.7-2.0

BODY

PIN

Part No.	Package
MSPC3-3.2L	1000

MOUNTING HOLE Ø3.0 THICKNESS 1.7

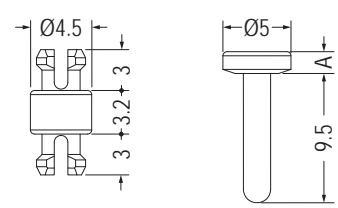

MOUNTING HOLE Ø3.0 THICKNESS 1.7

BODY

PIN

Part No.	A	Package
MSPC3-3.2	1.6	1000
MSPC3-3.2M	3.0	

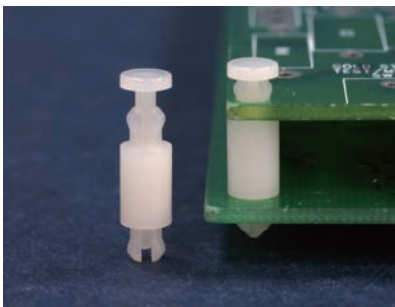

MOUNTING HOLE Ø3.0 THICKNESS 1.6

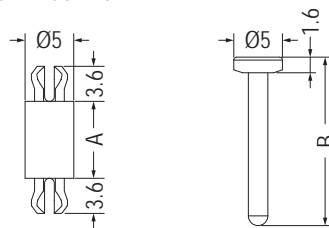

MOUNTING HOLE Ø3.0 THICKNESS 1.6

BODY

PIN

Part No.	A	B	Package
MSPF3-6.4	6.35	15.75	2000
MSPF3-8	7.9	17.3	
MSPF3-10	10.0	19.4	
MSPF3-12.7	12.7	22.1	
MSPF3-15.9	15.9	25.3	

導電PC板間隔柱 CONDUCTIVE SPACER SUPPORT

用途：快速固定PC板於機板上，上下板可導電，抗E.M.I美觀。

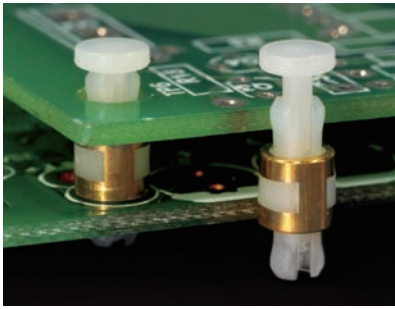

- Material: Nylon 66 (UL)
- Flame Class: 94V-2/94V-0
- Color: Natural/Black
- Unit: mm
- Patented (專利品)

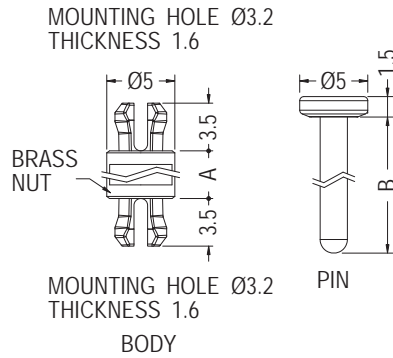

Part No.	A	B	Package
MSP-3	3.0	10.0	1000
MSP-4	4.0	11.0	
MSP-5	5.0	12.0	

PC板間隔柱 SPACER SUPPORT

用途：PC板與PC板間之固定，不佔空間。

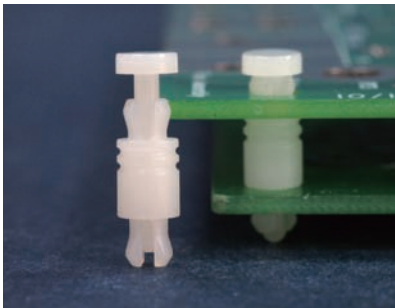

- Material: Nylon 66 (UL)
- Flame Class: 94V-2/94V-0
- Color: Natural/Black
- Unit: mm

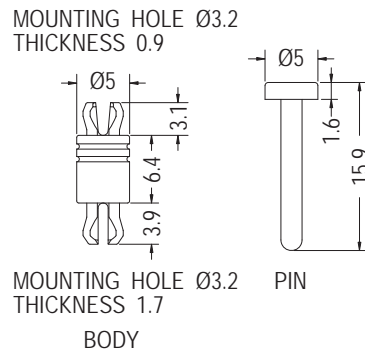

Part No.	Package
MSPB3.2-6.4	1000

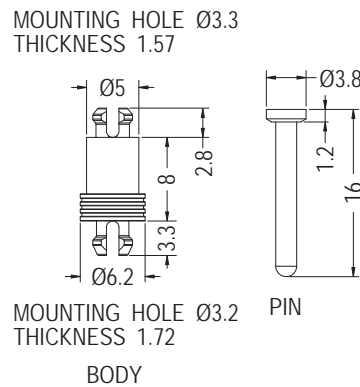
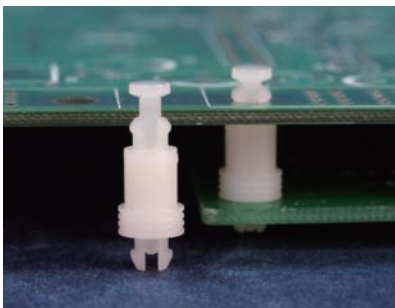

Part No.	Package
MSPB-8	1000

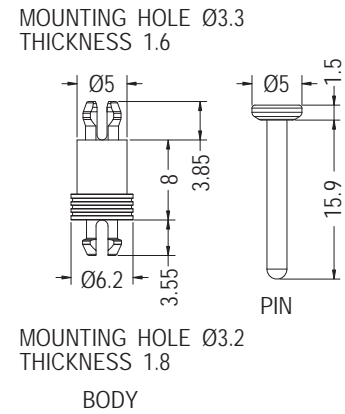

Part No.	Package
MSPB-8L	1000

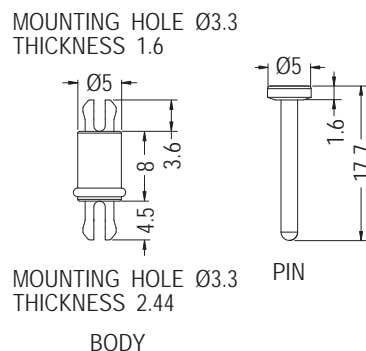
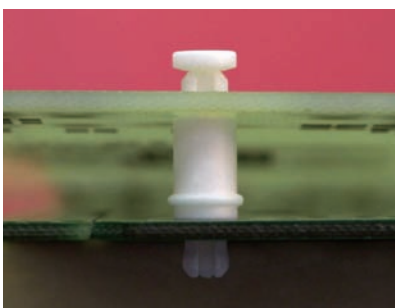

Part No.	Package
MSPF3.3-8L	1000

PC板間隔柱 SPACER SUPPORT

用途：PC板與PC板間之固定，不佔空間。

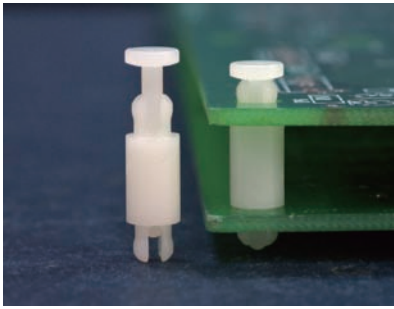

- Material: Nylon 66 (UL)
- Flame Class: 94V-2/94V-0
- Color: Natural/Black
- Unit: mm

MOUNTING HOLE Ø3.3
THICKNESS 1.6

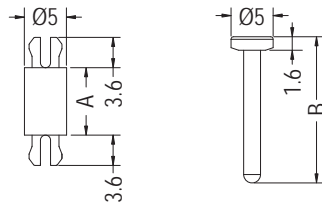

MOUNTING HOLE Ø3.3
THICKNESS 1.6

BODY

PIN

Part No.	A	B	Package
MSPF3.3-8	8.0	17.35	2000
MSPF3.3-17.5	17.5	26.3	

MOUNTING HOLE Ø3.3
THICKNESS 1.6

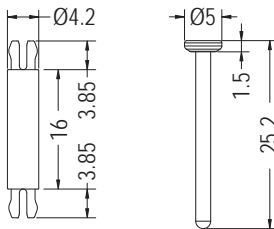

MOUNTING HOLE Ø3.3
THICKNESS 1.6

BODY

PIN

Part No.	Package
MSPCA-16	1000

MOUNTING HOLE Ø3.3
THICKNESS 2.2

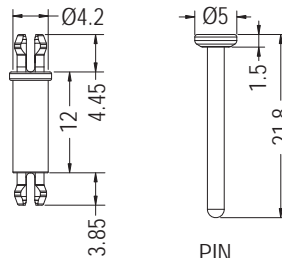

MOUNTING HOLE Ø3.3
THICKNESS 1.6

BODY

PIN

Part No.	Package
MSPCA3.3-12	1000

MOUNTING HOLE Ø3.3
THICKNESS 1.6

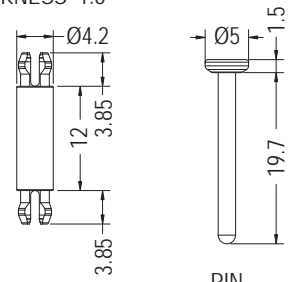

MOUNTING HOLE Ø3.3
THICKNESS 1.6

BODY

PIN

Part No.	Package
MSPCA3.3-12S	1000

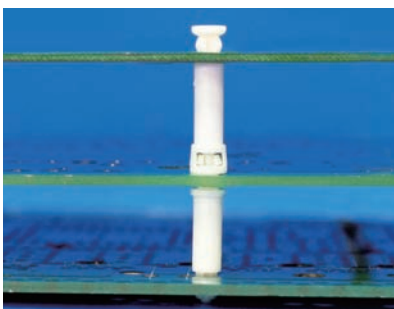

- Material: Nylon 66 (UL)
- Flame Class: 94V-2/94V-0
- Color: Natural/Black
- Unit: mm
- Patented (專利品)

MOUNTING HOLE Ø3.3
THICKNESS 2.2

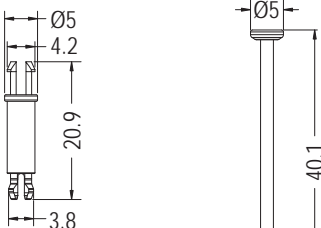

MOUNTING HOLE Ø3.3
THICKNESS 1.6

【 MSPO-1216A 】

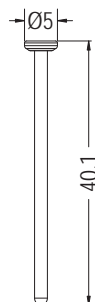

【 MSPO-1216C 】

MOUNTING HOLE Ø3.3
THICKNESS 1.6

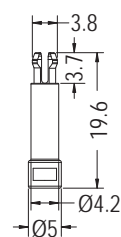

【 MSPO-1216BS 】

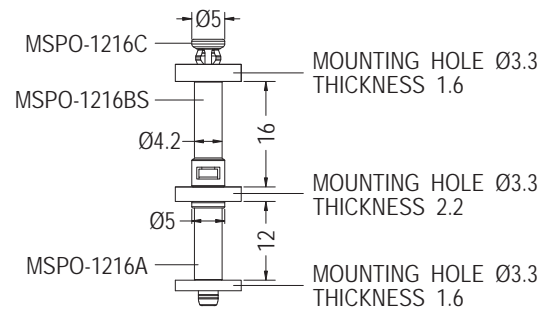

Part No.	Part No.	Package
MSPO-1216S	MSPO-1216A	1000
	MSPO-1216BS	
	MSPO-1216C	

PC板間隔柱 SPACER SUPPORT

用途：PC板與PC板間之固定，不佔空間。

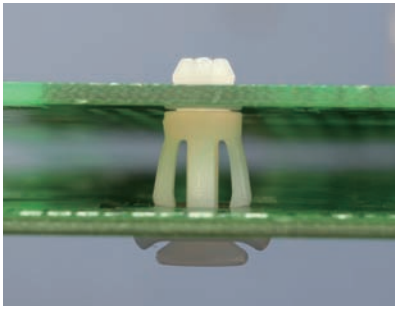

- Material: Nylon 66 (UL)
- Flame Class: 94V-2/94V-0
- Color: Natural/Black
- Unit: mm

MOUNTING HOLE $\varnothing 4.0$
THICKNESS 1.6

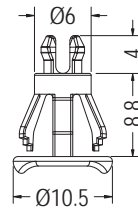

MOUNTING HOLE $\varnothing 7.0$
THICKNESS 0.8-1.6
BODY

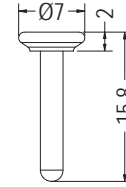

PIN

• Patented (專利品)

Part No.	Package
RCQC-7	1000

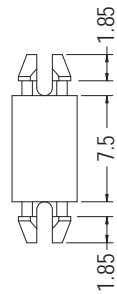
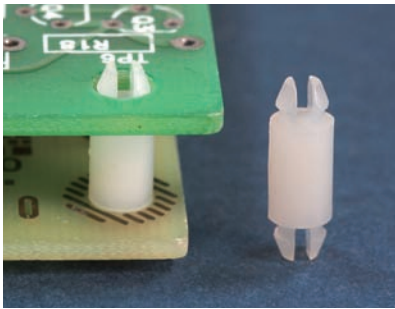

MOUNTING HOLE $\varnothing 3.2$
THICKNESS 1.0

MOUNTING HOLE $\varnothing 3.2$
THICKNESS 1.0

Part No.	Package
MSPS3S-7.5	1000

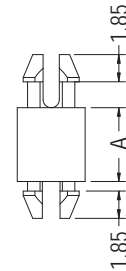

MOUNTING HOLE $\varnothing 3.2$
THICKNESS 1.6

MOUNTING HOLE $\varnothing 3.2$
THICKNESS 0.5

Part No.	A	Package
DMSB-5	5.0	1000
DMSB-8	8.0	

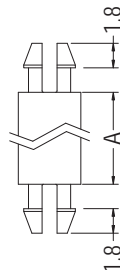
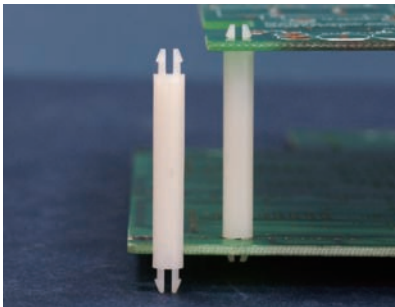

MOUNTING HOLE $\varnothing 3.2$
THICKNESS 1.6

MOUNTING HOLE $\varnothing 3.2$
THICKNESS 1.6

Part No.	A	Package
DMSS-28	28.6	1000
DMSS-38	38.1	

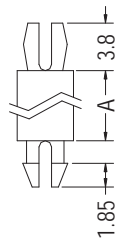
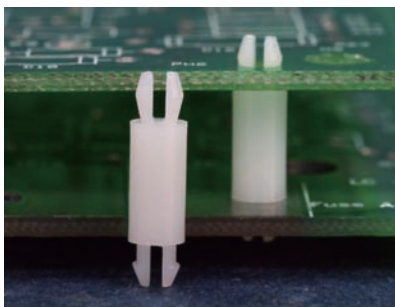

MOUNTING HOLE $\varnothing 3.2$
THICKNESS 1.6

MOUNTING HOLE $\varnothing 3.2$
THICKNESS 1.6

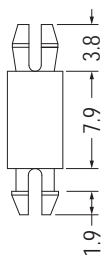

MOUNTING HOLE $\varnothing 3.2$
THICKNESS 1.73

MOUNTING HOLE $\varnothing 3.2$
THICKNESS 1.6

Part No.	Package
MSP3-8L	1000

Part No.	A	Package
MSP3-3	3.2	1000
MSP3-4	4.0	
MSP3-5	4.8	
MSP3-5.8	5.8	
MSP3-6	6.4	
MSP3-8	7.9	
MSP3-8.5	8.5	
MSP3-9.5	9.5	
MSP3-10	10.0	
MSP3-11	11.1	
MSP3-12S	12.0	
MSP3-12	12.7	

Part No.	A	Package
MSP3-14	14.3	1000
MSP3-15.9	15.9	
MSP3-16	16.0	
MSP3-17	17.5	
MSP3-19	19.1	
MSP3-20	20.6	
MSP3-21	21.0	
MSP3-22	22.2	
MSP3-25	25.4	
MSP3-27	27.0	
MSP3-28	28.5	
MSP3-29.2	29.2	
MSP3-31.7	31.7	
MSP3-31.8	31.8	
MSP3-34	34.9	
MSP3-38	38.1	

PC板間隔柱 SPACER SUPPORT

用途：PC板與PC板間之固定，不佔空間。

1

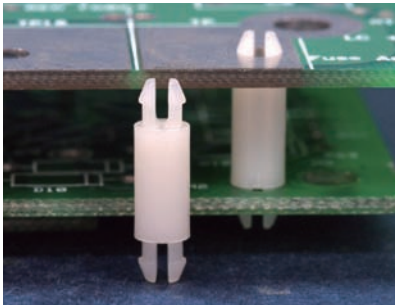

- Material: Nylon 66 (UL)
- Flame Class: 94V-2/94V-0
- Color: Natural/Black
- Unit: mm

MOUNTING HOLE Ø3.2
THICKNESS 0.8

MOUNTING HOLE Ø3.2
THICKNESS 1.6

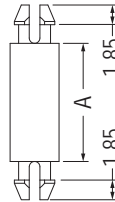
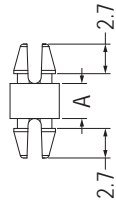

MOUNTING HOLE Ø3.2
THICKNESS 0.8

MOUNTING HOLE Ø3.2
THICKNESS 1.6

【 MSPS3-3S, MSPS3-3.2S 】

Part No.	A	Package
MSPS3-1.2	1.2	2000
MSPS3-3S	3.0	
MSPS3-3.2	3.2	
MSPS3-3.2S	3.2	
MSPS3-4	4.0	1000
MSPS3-4.8	4.8	
MSPS3-6.4	6.4	
MSPS3-8	7.9	
MSPS3-8.7	8.7	
MSPS3-9.5	9.5	
MSPS3-11.1	11.1	
MSPS3-12.7	12.7	
MSPS3-14.3	14.3	
MSPS3-15.9	15.9	
MSPS3-19.1	19.1	
MSPS3-20.6	20.6	
MSPS3-22.2	22.2	
MSPS3-25.4	25.4	
MSPS3-31.8	31.8	
MSPS3-34.9	34.9	

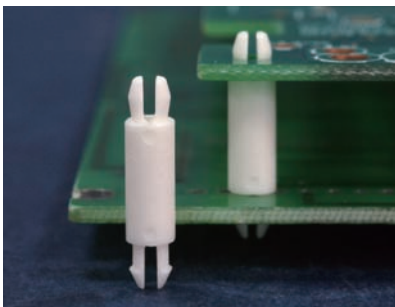

MOUNTING HOLE Ø3.2
THICKNESS 1.6

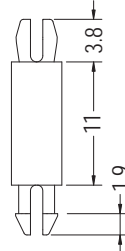

MOUNTING HOLE Ø3.2
THICKNESS 2.4

Part No.	Package
MSPL-11	1000

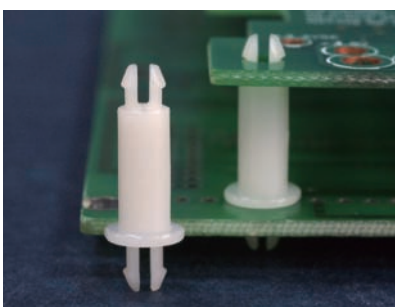

MOUNTING HOLE Ø3.2
THICKNESS 1.7

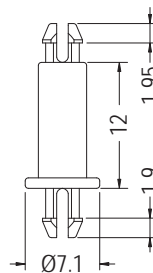

MOUNTING HOLE Ø3.2
THICKNESS 2.7

Part No.	Package
MSPMA-12	1000

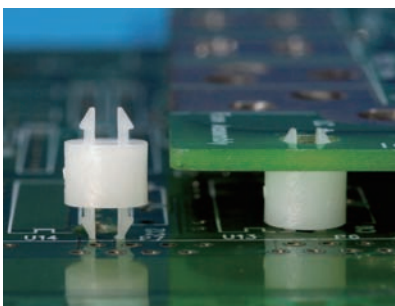

MOUNTING HOLE Ø3.3
THICKNESS 0.8

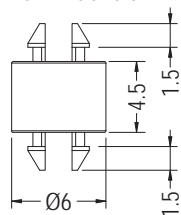

MOUNTING HOLE Ø3.3
THICKNESS 0.8

Part No.	Package
DMSC-4.5	2000

- Material: Nylon 66 (UL)
- Flame Class: 94V-2/94V-0
- Color: Natural/Black
- Unit: mm

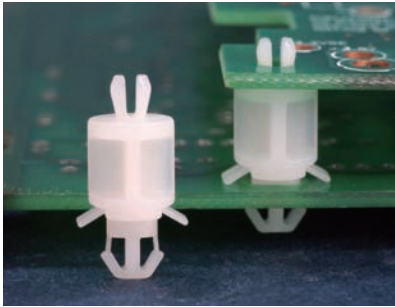
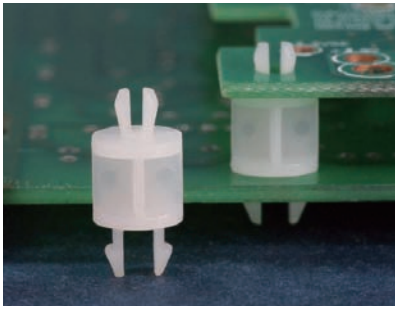

MOUNTING HOLE Ø3.3
THICKNESS 1.6

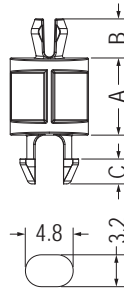

MOUNTING HOLE
THICKNESS: T

Part No.	A	B	C	T	Package
MSPD-7.9	7.9	4.1	2.6	2.16	1000
MSPD-7.9S	7.9	4.1	2.55	1.6	
MSPD-7.9L	7.9	4.1	2.55	2.34	
MSPD-12	12.0	4.1	2.55	2.16	
★MSPD-12M	12.0	4.0	2.55	2.7	
MSPD-16	16.0	4.1	2.55	2.16	

MOUNTING HOLE Ø3.3
THICKNESS 1.6

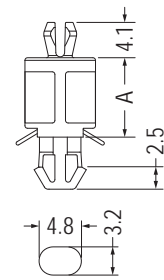

MOUNTING HOLE
THICKNESS 2.7-3.3

Part No.	A	Package
MSPN-9	9.0	1000
MSPN-12	12.0	

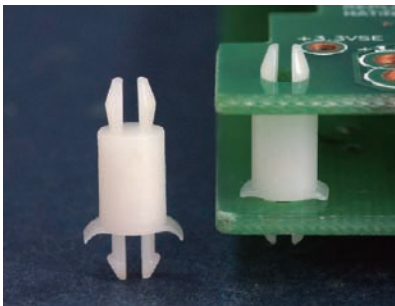

MOUNTING HOLE Ø3.3
THICKNESS 1.6-1.7

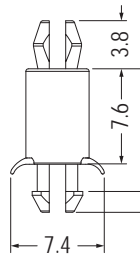

MOUNTING HOLE Ø3.2
THICKNESS 1.7-2.1

Part No.	Package
MSPH-7.5	1000

MOUNTING HOLE Ø4.3
THICKNESS 1.6-1.7

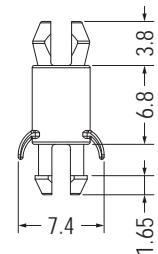

MOUNTING HOLE Ø4.0
THICKNESS 1.7-2.5

Part No.	Package
MSPH-6.8L	1000

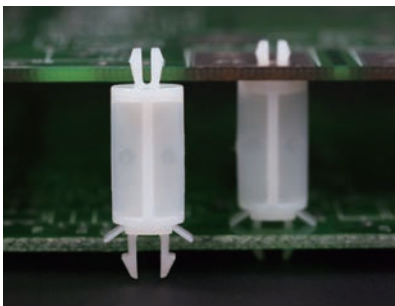

MOUNTING HOLE Ø3.3
THICKNESS 1.6

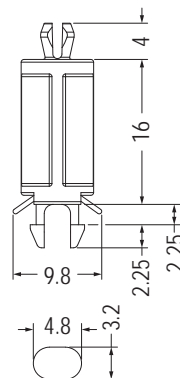

MOUNTING HOLE
THICKNESS 1.8-2.0

Part No.	Package
MSPQ-16	1000

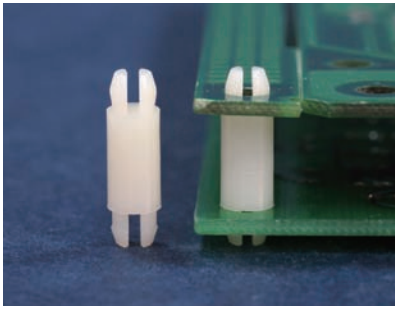

- Material: Nylon 66 (UL)
- Flame Class: 94V-2/94V-0
- Color: Natural/Black
- Unit: mm

MOUNTING HOLE Ø3.9
THICKNESS 1.6

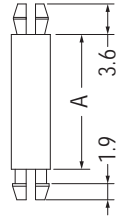

MOUNTING HOLE Ø3.9
THICKNESS 1.6

【MSP-15.9S】

MOUNTING HOLE Ø4.0
THICKNESS 1.6

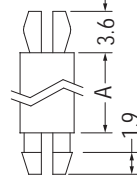

MOUNTING HOLE Ø4.0
THICKNESS 1.6

Part No.	A	Package
MSP-3	3.2	1000
MSP-4	4.0	
MSP-4.5	4.5	
MSP-5	5.0	
MSP-6	6.3	
MSP-7	7.0	
MSP-8	8.0	
MSP-9	9.5	
MSP-10	10.5	
MSP-12	12.7	
MSP-14	14.0	
MSP-15	15.9	
MSP-15.9S	15.9	
MSP-19	19.0	
MSP-22	22.0	

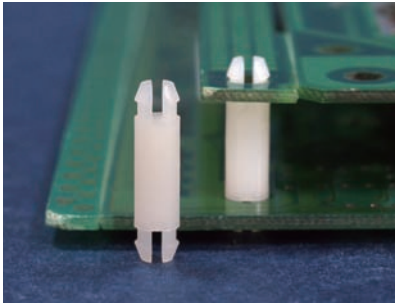

MOUNTING HOLE Ø4.0
THICKNESS 1.6

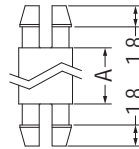

MOUNTING HOLE Ø4.0
THICKNESS 1.6

Part No.	A	Package
DMSP-4.8	4.8	1000
DMSP-6.4	6.4	
DMSP-11.1	11.1	

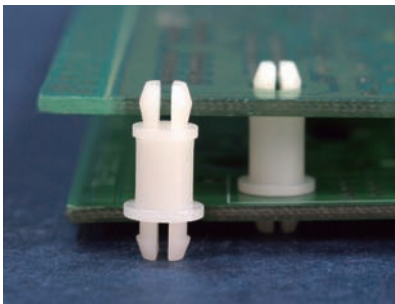

MOUNTING HOLE Ø4.0
THICKNESS 1.6

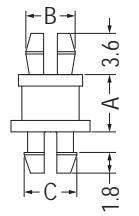

MOUNTING HOLE Ø4.0
THICKNESS 1.6

Part No.	A	B	C	Package
DMSPS-5	5.0	4.3	4.6	1000
DMSPS-6.4	6.4	4.4	4.6	
DMSPS-7.9	7.9	4.3	4.6	
DMSPS-12.7	12.7	4.3	4.6	
DMSPS-17.5	17.5	4.3	4.6	
DMSPS-17.5S	17.5	4.2	4.25	

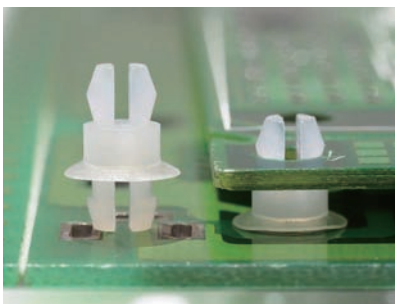

MOUNTING HOLE Ø3.9
THICKNESS 1.6

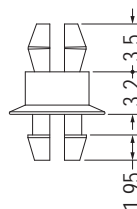

MOUNTING HOLE Ø3.9
THICKNESS 1.6

MOUNTING HOLE Ø3.96
THICKNESS 1.58

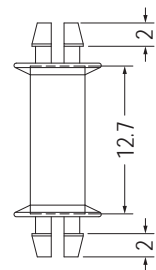

MOUNTING HOLE Ø3.96
THICKNESS 1.58

- Color: Green



Part No.	Package
MSPV-3	1000

Part No.	Package
★MSPY-12.7	1000

PC板間隔柱 SPACER SUPPORT

用途：PC板與PC板間之固定，不佔空間。

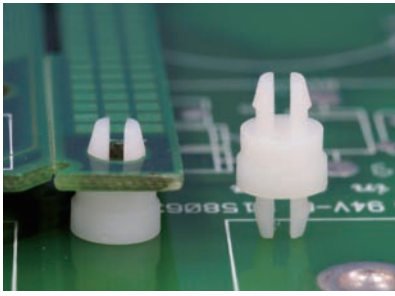

- Material: Nylon 66 (UL)
- Flame Class: 94V-2/94V-0
- Color: Natural/Black
- Unit: mm

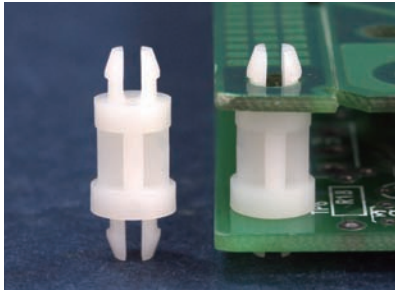

MOUNTING HOLE Ø4.0
THICKNESS 1.57

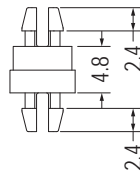

MOUNTING HOLE Ø4.0
THICKNESS 1.57

Part No.	Package
SP1-4.8	2000

MOUNTING HOLE Ø4.0
THICKNESS 1.6

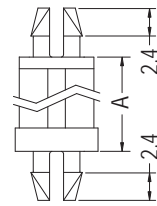

MOUNTING HOLE Ø4.0
THICKNESS 1.6

Part No.	A	Package
MSPM-5	4.8	1000
MSPM-24	23.8	

MOUNTING HOLE Ø4.0
THICKNESS 1.6

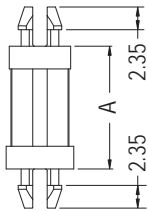

MOUNTING HOLE Ø4.0
THICKNESS 1.6

MOUNTING HOLE Ø4.0
THICKNESS 1.6

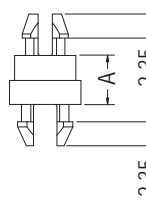

MOUNTING HOLE Ø4.8
THICKNESS 1.6

MOUNTING HOLE Ø4.0
THICKNESS 1.6

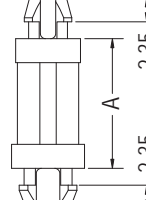

MOUNTING HOLE Ø4.8
THICKNESS 1.6

【 MSPK45-4.8 】

Part No.	A	Package
MSPK45-4.8	4.8	2000
MSPK45-6.4	6.4	
MSPK45-9.5	9.5	
MSPK45-12.7	12.7	1000
MSPK45-15.9	15.9	
MSPK45-19.1	19.1	
MSPK45-22.2	22.2	
MSPK45-25.4	25.4	

MOUNTING HOLE Ø4.8
THICKNESS 1.6

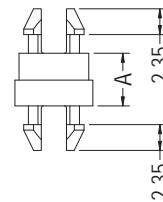

MOUNTING HOLE Ø4.8
THICKNESS 1.6

MOUNTING HOLE Ø4.8
THICKNESS 1.6

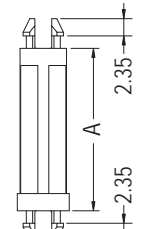

MOUNTING HOLE Ø4.8
THICKNESS 1.6

【 MSPK4.8-4.8 】

Part No.	A	Package
MSPK4.8-4.8	4.8	2000
MSPK4.8-6.4	6.4	
MSPK4.8-9.5	9.5	
MSPK4.8-12.7	12.7	1000
MSPK4.8-15.9	15.9	
MSPK4.8-19.1	19.1	
MSPK4.8-22.2	22.2	
MSPK4.8-25.4	25.4	
MSPK4.8-31.7	31.75	

Part No.	A	Package
MSP1-6.4	6.4	1000
MSP1-9.5	9.5	
MSP1-10	10.0	
MSP1-12.7	12.7	
MSP1-15.9	15.9	
MSP1-17	17.0	
MSP1-19.1	19.1	
MSP1-22.2	22.2	
MSP1-25.4	25.4	

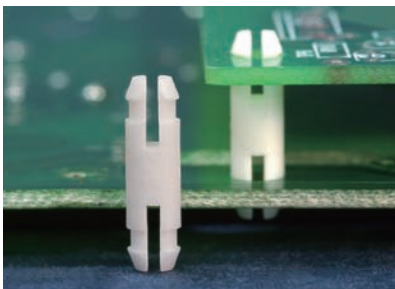
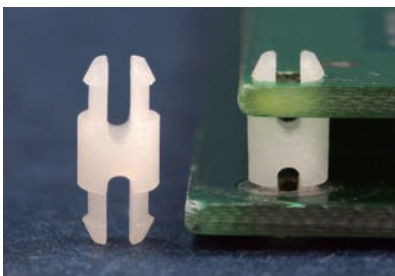

MOUNTING HOLE Ø3.0
THICKNESS 1.6

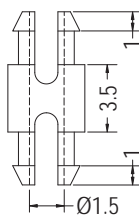

MOUNTING HOLE Ø3.0
THICKNESS 1.6

Part No.	Package
SSDU1-3.5	1000

MOUNTING HOLE Ø4.0
THICKNESS 1.6

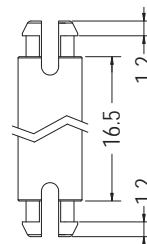

MOUNTING HOLE Ø4.0
THICKNESS 1.6

Part No.	Package
SSDUA-16.5	1000

MOUNTING HOLE Ø4.0
THICKNESS 1.6

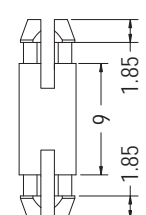

MOUNTING HOLE Ø4.0
THICKNESS 1.6

Part No.	Package
DMSA-9	1000

PC板間隔柱 SPACER SUPPORT

用途：PC板與PC板間之固定，不佔空間。

1

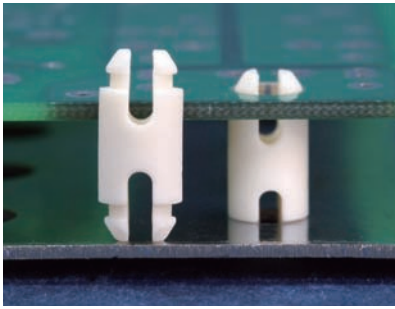

- Material: Nylon 66 (UL)
- Flame Class: 94V-2/94V-0
- Color: Natural/Black
- Unit: mm

MOUNTING HOLE Ø5.2
THICKNESS: T

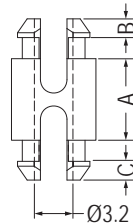

MOUNTING HOLE Ø5.2
THICKNESS: T

Part No.	A	B	C	T	Package
SSDU-9.2	9.2	1.55	1.55	1.6	1000
SSDU-9.6	9.6	1.85	1.85	1.2	

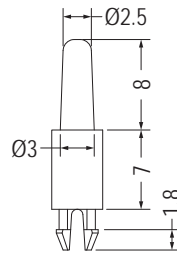
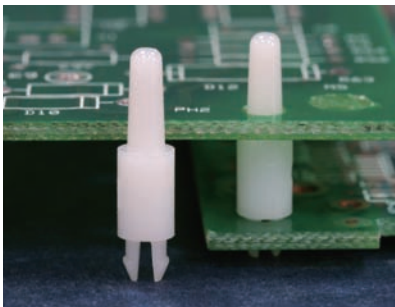

MOUNTING HOLE Ø3.2
THICKNESS 1.6

Part No.	Package
MSPE-7	1000

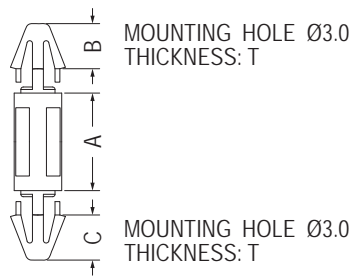
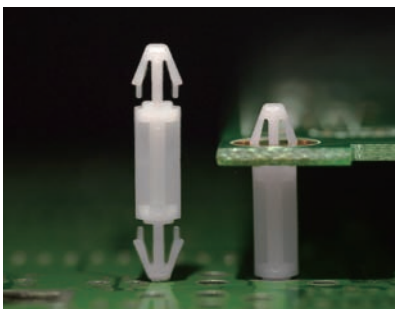

MOUNTING HOLE Ø3.0
THICKNESS: T

MOUNTING HOLE Ø3.0
THICKNESS: T

Part No.	A	B	C	T	Package
LCVU-8	8.0	3.7	3.7	1.2-1.8	1000
LCVU-9	9.0	3.55	3.55	2.0	
LCVU-10	10.0	3.7	3.7	1.2-1.8	

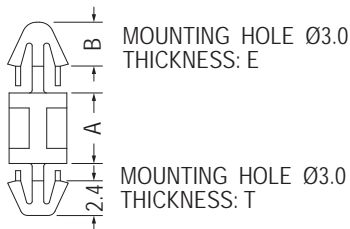

MOUNTING HOLE Ø3.0
THICKNESS: E

MOUNTING HOLE Ø3.0
THICKNESS: T

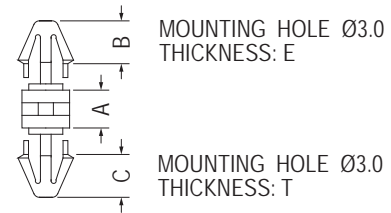

MOUNTING HOLE Ø3.0
THICKNESS: E

MOUNTING HOLE Ø3.0
THICKNESS: T

Part No.	A	B	E	T	Package
LCVA-2	2.0	3.1	1.6	0.8-1.0	2000
LCVA-2.5	2.5	3.0	0.8-1.0	1.6	
LCVA-4	4.0	3.1	1.6	0.8-1.0	
LCVA-5	5.0	3.1	1.6	0.8-1.0	

Part No.	A	B	C	E	T	Package
LCV-2.5	2.5	3.4	3.4	1.6	1.6	1000
LCV-3	3.0	3.55	3.55	1.6	1.6	
LCV-5	5.0	3.4	3.4	1.8	1.8	
LCV-6	6.0	3.6	3.6	1.2-1.7	0.8-1.0	

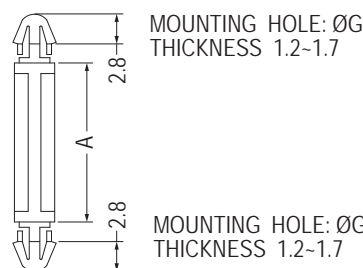
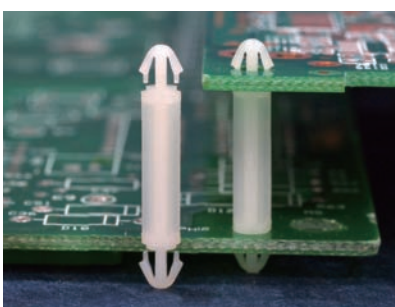

MOUNTING HOLE: ØG
THICKNESS 1.2-1.7

MOUNTING HOLE: ØG
THICKNESS 1.2-1.7

Part No.	A	G	Package
LCJ-14	14.0	3.0	1000
LCJ-15	15.0	3.2	
LCJ-19	19.0	3.0	
LCJ-21	21.0	3.0	

PC板間隔柱 SPACER SUPPORT

用途：PC板與PC板間之固定，不佔空間。

- Material: Nylon 66 (UL)
- Flame Class: 94V-2/94V-0
- Color: Natural/Black
- Unit: mm

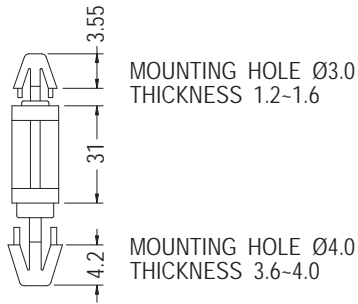
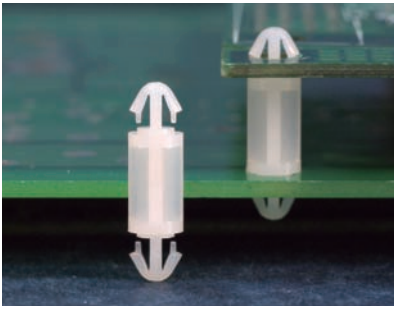

Part No.	Package
LCX-31	2000

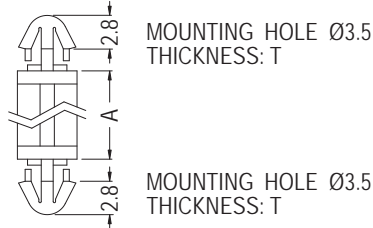

Part No.	A	T	Package
LCI-2.5	2.5	1.2~1.7	2000
LCI-3	3.0	1.2~1.7	
LCI-3.5	3.5	1.2~1.7	
LCI-4	4.0	1.2~1.7	
LCI-4.5	4.5	1.2~1.7	
LCI-5	5.0	1.2~1.7	
LCI-5.5	5.5	1.2~1.7	

Part No.	A	T	Package
LCI-6	6.0	1.2~1.7	1000
LCI-6.5	6.35	1.2~1.7	
LCI-7	7.0	1.2~1.7	
LCI-8	8.0	1.2~1.7	
LCI-9	9.0	1.2~1.7	
LCI-10	10.0	1.2~1.7	
LCI-10L	10.0	2.38	
LCI-11	11.0	1.2~1.7	
LCI-12	12.0	1.2~1.7	
LCI-15	15.0	1.2~1.7	
LCI-15(2)	15.0	1.6~2.4	
LCI-20	20.0	1.2~1.7	500
LCI-22	22.0	1.2~1.7	
LCI-30L	30.0	1.6~2.4	

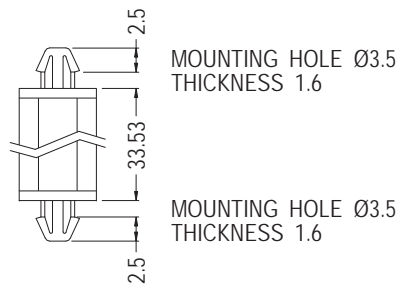
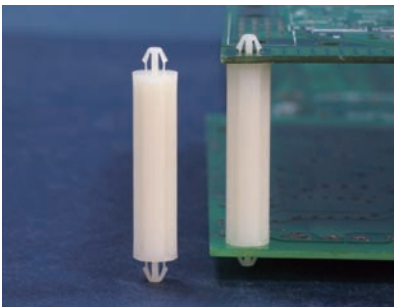

Part No.	Package
LDE-33	1000

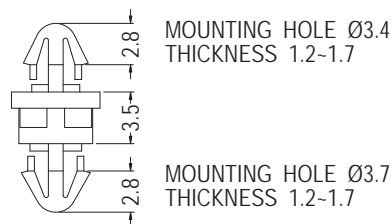
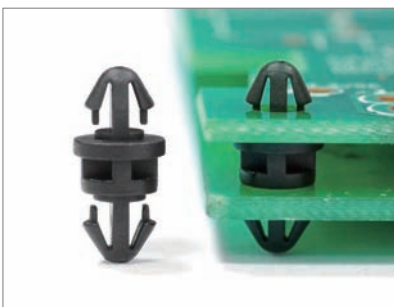

Part No.	Package
LCIA-3.5	1000

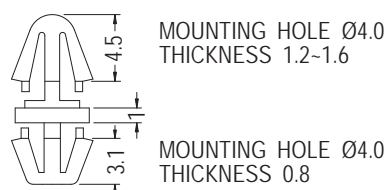
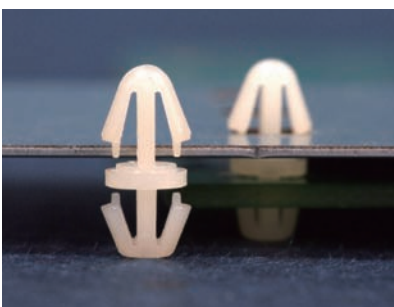

Part No.	Package
LCK-1	1000

PC板間隔柱 SPACER SUPPORT

用途：PC板與PC板間之固定，不佔空間。

1

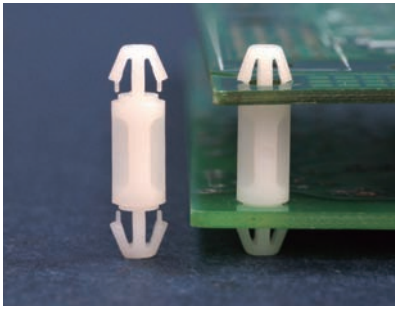

- Material: Nylon 66 (UL)
- Flame Class: 94V-2/94V-0
- Color: Natural/Black
- Unit: mm

MOUNTING HOLE $\varnothing 4.0$
THICKNESS 1.2-1.7

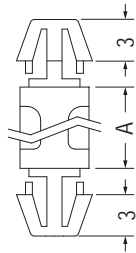

MOUNTING HOLE $\varnothing 4.0$
THICKNESS 1.2-1.7

Part No.	A	Package
LCC-3S	3.0	2000
LCC-3	3.5	
LCC-4	4.0	
LCC-5	5.0	
LCC-6S	6.0	
LCC-6	6.4	
LCC-7	7.0	1000
LCC-8	8.0	
LCC-9.5	9.5	
LCC-10S	10.0	
LCC-10	10.5	
LCC-11.5	11.5	
LCC-12S	12.0	

Part No.	A	Package
LCC-12	12.7	1000
LCC-14	14.0	
LCC-15	15.9	
LCC-18	18.0	
LCC-19	19.0	
LCC-20	20.0	
LCC-25	25.0	
LCC-25.4	25.4	
LCC-27	27.0	
LCC-30	30.0	
LCC-34	34.0	500
LCC-40	40.0	
LCC-45	45.0	
LCC-55	55.0	
LCC-69	69.0	
LCC-71	71.2	
LCC-72	72.0	
LCC-74	74.2	
LCC-80	80.0	

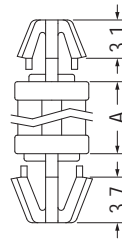
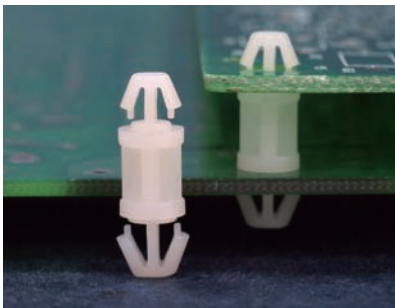

MOUNTING HOLE $\varnothing 4.0$
THICKNESS 1.6

MOUNTING HOLE $\varnothing 4.8$
THICKNESS 1.6

Part No.	A	Package
LCBM-3	3.0	1000
LCBM-4	4.0	
LCBM-6	6.0	
LCBM-8	8.0	
LCBM-10	10.0	
LCBM-12	12.0	
LCBM-14	14.0	
LCBM-16	16.0	
LCBM-18	18.0	

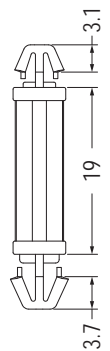

MOUNTING HOLE $\varnothing 4.0$
THICKNESS 1.6

MOUNTING HOLE $\varnothing 4.8$
THICKNESS 2.4

Part No.	Package
LCBM-19L	1000

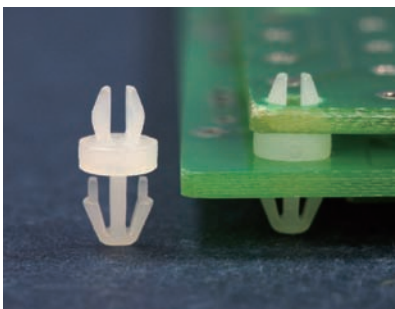

MOUNTING HOLE $\varnothing 2.6$
THICKNESS 1.0

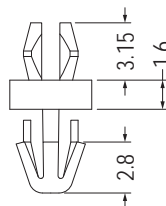

MOUNTING HOLE $\varnothing 2.8$
THICKNESS 1.6

Part No.	Package
MSPA-1.6	2000

MOUNTING HOLE $\varnothing 2.8$
THICKNESS 1.6

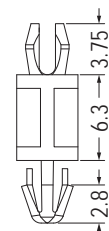

MOUNTING HOLE $\varnothing 2.8$
THICKNESS 1.6

Part No.	Package
MSPA-6.3L	1000

PC板間隔柱 SPACER SUPPORT

用途：PC板與PC板間之固定，不佔空間。

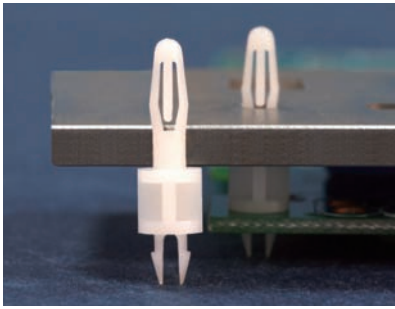

- Material: Nylon 66 (UL)
- Flame Class: 94V-2/94V-0
- Color: Natural/Black
- Unit: mm

MOUNTING HOLE Ø3.0
THICKNESS 4.0

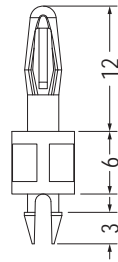

MOUNTING HOLE Ø3.0
THICKNESS 1.6

Part No.	Package
LMSA-6	1000

MOUNTING HOLE Ø3.2
THICKNESS 1.6

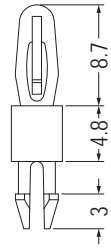

MOUNTING HOLE Ø3.2
THICKNESS 2.6

Part No.	Package
★LMSE-4.8	1000



- Material: Nylon 66 (UL)
- Flame Class: 94V-2/94V-0
- Color: Natural/Black
- Unit: mm

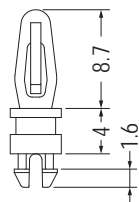

MOUNTING HOLE Ø3.2
THICKNESS 1.6

MOUNTING HOLE Ø3.2
THICKNESS 1.0-1.2

Part No.	Package
LMSB-4	1000

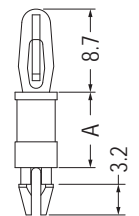
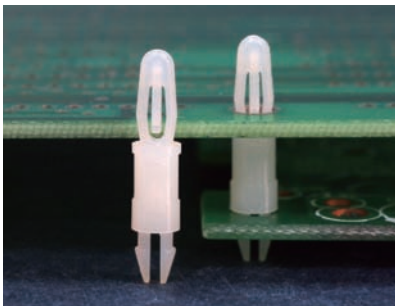

MOUNTING HOLE Ø3.2
THICKNESS 1.6-1.8

MOUNTING HOLE Ø3.2
THICKNESS 1.6

Part No.	A	Package
LMSP-8	7.9	1000
LMSP-9.5	9.5	
LMSP-16	15.9	

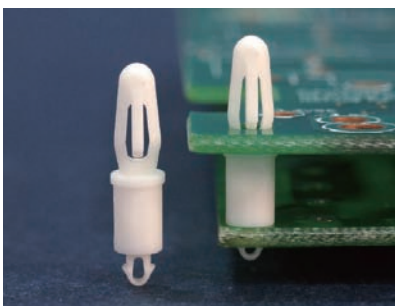

- Material: Nylon 66 (UL)
- Flame Class: 94V-2/94V-0
- Color: Natural/Black
- Unit: mm

MOUNTING HOLE Ø3.2
THICKNESS 1.6-1.7

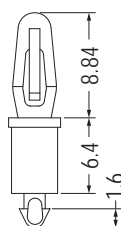

MOUNTING HOLE Ø2.0
THICKNESS 1.0-1.2

Part No.	Package
LCPL-6.4	1000

MOUNTING HOLE Ø3.5
THICKNESS 1.6

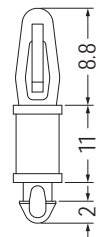

MOUNTING HOLE Ø2.6
THICKNESS 1.6

Part No.	Package
LCPLB-11	1000

PC板間隔柱 SPACER SUPPORT

用途：PC板與PC板間之固定，不佔空間。

1

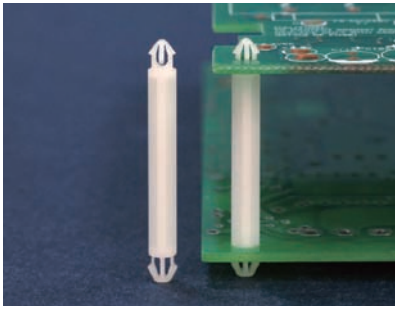

- Material: Nylon 66 (UL)
- Flame Class: 94V-2/94V-0
- Color: Natural/Black
- Unit: mm

MOUNTING HOLE Ø3.3
THICKNESS 1.6-2.1

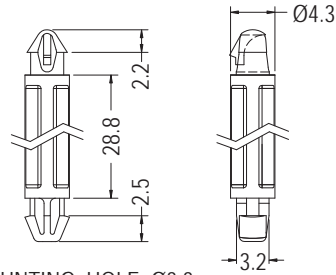

MOUNTING HOLE Ø3.3
THICKNESS 1.6

Part No.	Package
LCOA-28.8	1000

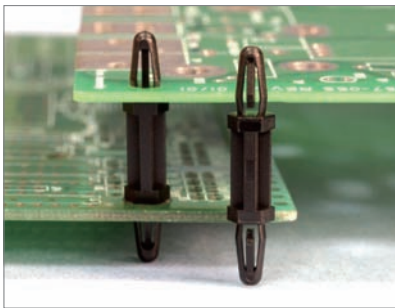

- Material: Nylon 66 (UL)
- Flame Class: 94V-2/94V-0
- Color: Natural/Black
- Unit: mm

MOUNTING HOLE Ø4.0
THICKNESS 1.6

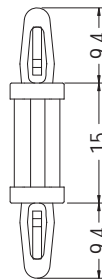

MOUNTING HOLE Ø4.0
THICKNESS 1.6

Part No.	Package
LCSF-15	1000

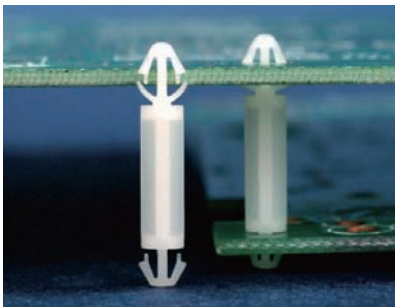

- Material: Nylon 66 (UL)
- Flame Class: 94V-2/94V-0
- Color: Natural/Black
- Unit: mm

MOUNTING HOLE Ø3.0
THICKNESS 1.6

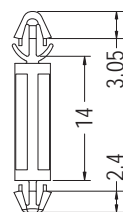

MOUNTING HOLE Ø3.0
THICKNESS: T

Part No.	T	Package
LCGA-14	0.8-1.0	1000
LCGA-14S	0.6	

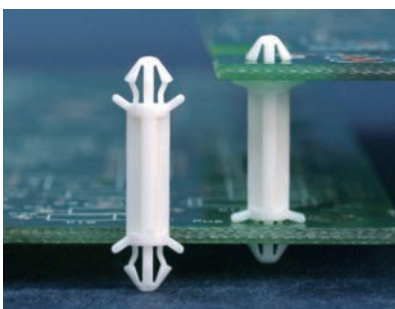

- Material: Nylon 66 (UL)
- Flame Class: 94V-2/94V-0
- Color: Natural/Black
- Unit: mm

MOUNTING HOLE Ø3.0
THICKNESS 1.2-1.6

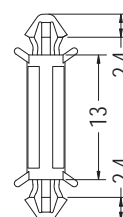

MOUNTING HOLE Ø3.0
THICKNESS 1.2-1.6

Part No.	Package
CBSA-13	1000

PC板間隔柱 SPACER SUPPORT

用途：PC板與PC板間之固定，不佔空間。

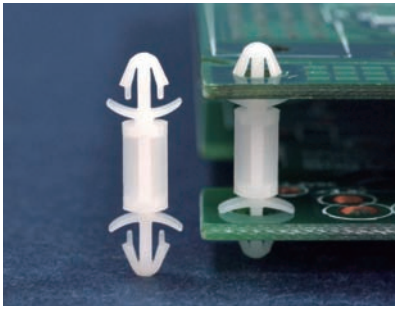

- Material: Nylon 66 (UL)
- Flame Class: 94V-2/94V-0
- Color: Natural/Black
- Unit: mm

MOUNTING HOLE Ø3.0
THICKNESS 1.2-2.0

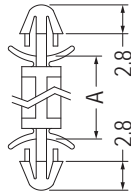

MOUNTING HOLE Ø3.0
THICKNESS 1.2-2.0

Part No.	A	Package
LCF-3	3.2	1000
LCF-4	4.0	
LCF-5	5.0	
LCF-6S	6.0	
LCF-6	6.35	
LCF-7	7.0	
LCF-8	8.0	
LCF-9	9.5	
LCF-10.6	10.6	

Part No.	A	Package
LCF-11	11.2	1000
LCF-12	12.0	
LCF-14.4	14.4	
LCF-15	15.0	
LCF-16	16.0	
LCF-17	17.0	
LCF-20	20.2	
LCF-22	22.0	
LCF-25	25.4	

MOUNTING HOLE Ø3.0
THICKNESS 1.2-2.0

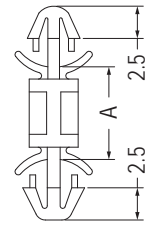

MOUNTING HOLE Ø3.5
THICKNESS 1.6-2.0

Part No.	A	Package
LCFO-3	3.0	1000
LCFO-3.5	3.5	
LCFO-4	4.0	
LCFO-4.8	4.8	
LCFO-6	6.0	
LCFO-6.4	6.4	
LCFO-7	7.0	
LCFO-8	8.0	
LCFO-9	9.0	
LCFO-10	10.0	
LCFO-11.5	11.5	
LCFO-12.7	12.7	
LCFO-14	14.0	
LCFO-16	16.0	

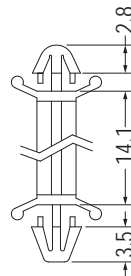
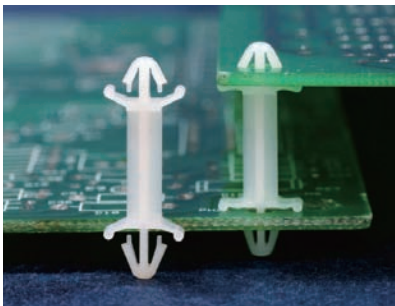

MOUNTING HOLE Ø3.5
THICKNESS 1.0

MOUNTING HOLE Ø3.5
THICKNESS 1.6

Part No.	Package
CBCS-14	1000

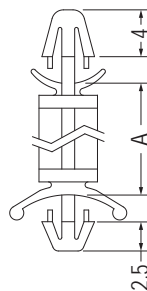
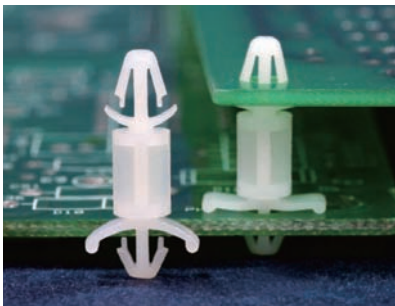

MOUNTING HOLE Ø3.5
THICKNESS 1.6

MOUNTING HOLE Ø3.5
THICKNESS 0.8-2.0

Part No.	A	Package
LCD-3	3.2	2000
LCD-4	4.0	
LCD-5	4.8	1000
LCD-6	6.4	
LCD-7	7.0	
LCD-8	8.0	
LCD-9	9.6	
LCD-11	11.2	
LCD-12	12.7	
LCD-14	14.0	
LCD-16	16.0	
LCD-18	18.0	
LCD-19	19.1	
LCD-27	27.5	

PC板間隔柱 SPACER SUPPORT

用途：PC板與PC板間之固定，不佔空間。

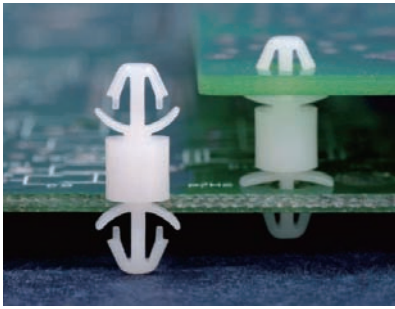

- Material: Nylon 66 (UL)
- Flame Class: 94V-2/94V-0
- Color: Natural/Black
- Unit: mm

MOUNTING HOLE Ø3.5
THICKNESS 1.6-2.0

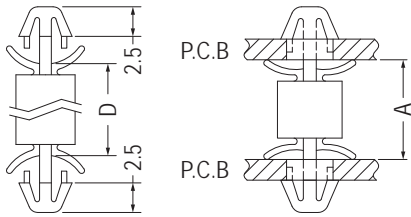

MOUNTING HOLE Ø3.5
THICKNESS 1.6-2.0

Part No.	A	D	Package
LCO-5	5.0	3.6	1000
LCO-6.4	6.4	5.0	
LCO-8	8.0	4.7	

MOUNTING HOLE Ø3.5
THICKNESS 1.6-2.0

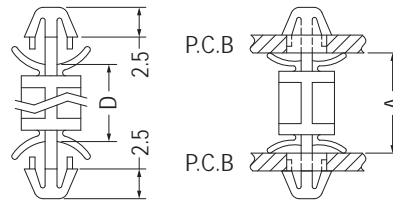

MOUNTING HOLE Ø3.5
THICKNESS 1.6-2.0

Part No.	A	D	Package
LCO-10	10.0	8.6	1000
LCO-11	11.0	9.6	
LCO-12.7	12.7	11.3	
LCO-15.9	15.9	14.5	

MOUNTING HOLE Ø3.5
THICKNESS 2.0-2.5

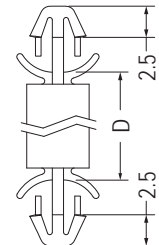

MOUNTING HOLE Ø3.5
THICKNESS 2.0-2.5



Part No.	D	Package
LCO-10L	10.1	1000
LCO-10.5L	10.5	

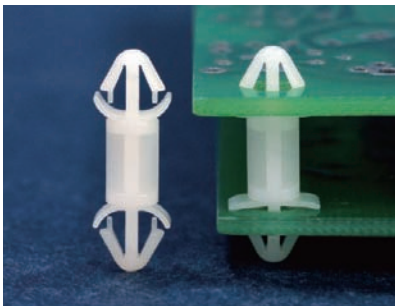

MOUNTING HOLE Ø4.0
THICKNESS 1.6

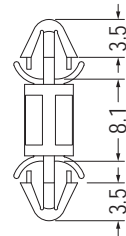

MOUNTING HOLE Ø4.0
THICKNESS 1.6

Part No.	Package
LCFB-8	1000

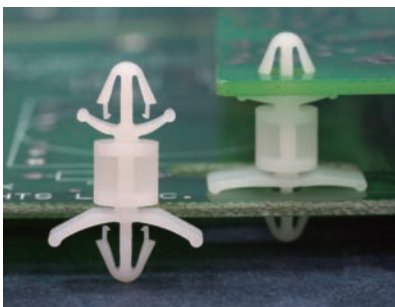

MOUNTING HOLE Ø4.0
THICKNESS 1.6

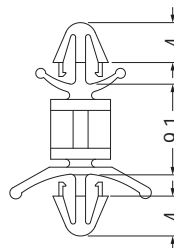

MOUNTING HOLE Ø4.0
THICKNESS 1.6

Part No.	Package
LCBJ-9	1000

MOUNTING HOLE Ø4.0
THICKNESS 0.8-1.7

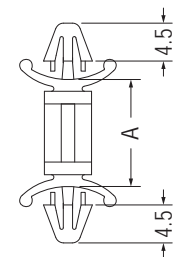

MOUNTING HOLE Ø4.0
THICKNESS 0.8-1.7

Part No.	A	Package
LCTA-4.8	4.8	2000
LCTA-12.7	12.7	1000

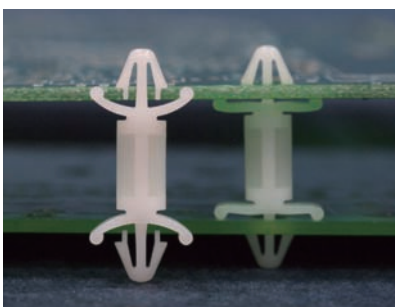

PC板間隔柱 SPACER SUPPORT

用途：PC板與PC板間之固定，不佔空間。

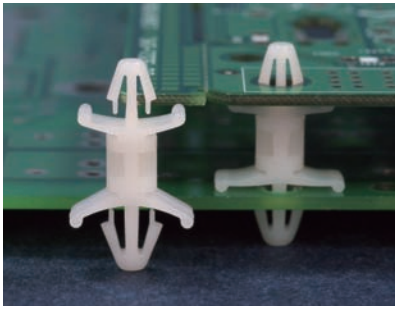

- Material: Nylon 66 (UL)
- Flame Class: 94V-2/94V-0
- Color: Natural/Black
- Unit: mm

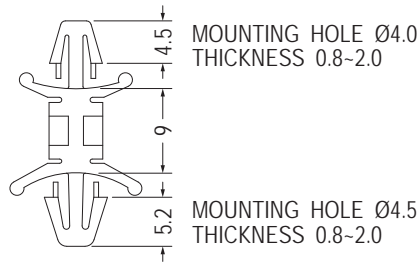

Part No.	Package
LCT-9	1000

MOUNTING HOLE Ø4.0
THICKNESS 1.0

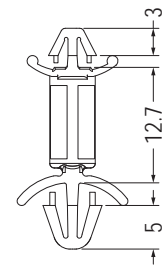

MOUNTING HOLE Ø4.8
THICKNESS 1.6

Part No.	Package
LCBD-12.7	1000

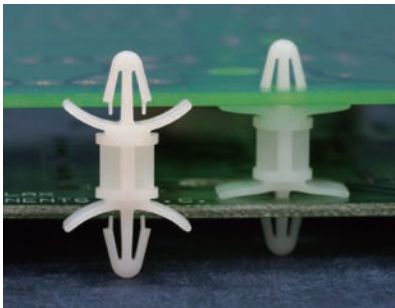

MOUNTING HOLE Ø4.0
THICKNESS: T

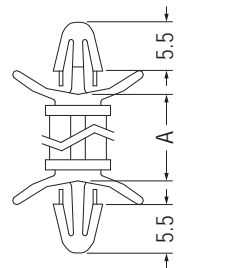

MOUNTING HOLE Ø4.0
THICKNESS: T

Part No.	A	T	Package
LCEO-5	4.8	0.8-2.0	1000
LCEO-6	6.4	0.8-2.0	
LCEO-8	7.9	0.8-2.0	
LCEO-9	9.5	0.8-2.0	
LCEO-12	12.7	0.8-2.0	
LCEO-12L	11.9	1.2-2.3	
LCEO-15	15.9	0.8-2.0	
LCEO-19	19.0	0.8-2.0	
LCEO-22	22.2	0.8-2.0	

MOUNTING HOLE Ø4.0
THICKNESS 1.6-2.0

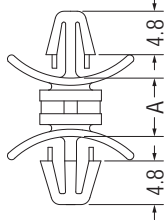

MOUNTING HOLE Ø4.8
THICKNESS 0.8-2.0

Part No.	A	Package
LCBZ-4.8	4.8	1000
LCBZ-6.4	6.4	

MOUNTING HOLE Ø4.8
THICKNESS 0.8-2.0

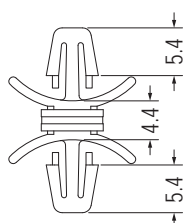

MOUNTING HOLE Ø4.8
THICKNESS 0.8-2.0

Part No.	Package
LCBYR-4.8	1000

MOUNTING HOLE Ø4.8
THICKNESS 0.8-2.0

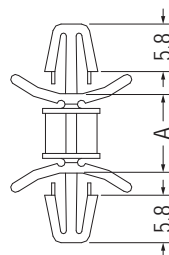

MOUNTING HOLE Ø4.8
THICKNESS 0.8-2.0

Part No.	A	Package
LCBY-4.8	4.8	1000
LCBY-6.4	6.4	
LCBY-9.5	9.5	
LCBY-12.7	12.7	
LCBY-15.9	15.9	
LCBY-19.1	19.1	
LCBY-22.2	22.2	

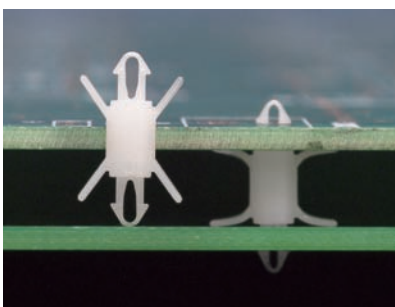

MOUNTING HOLE Ø2.0
THICKNESS 0.8-1.6

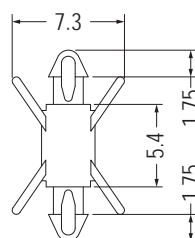

MOUNTING HOLE Ø2.0
THICKNESS 0.8-1.6

Part No.	Package
MADG-5.4	2000

PC板間隔柱 SPACER SUPPORT

用途：PC板與PC板間之固定，不佔空間。

1

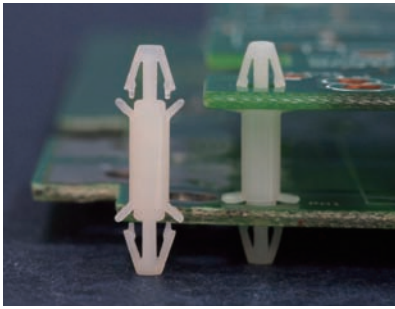

- Material: Nylon 66 (UL)
- Flame Class: 94V-2/94V-0
- Color: Natural/Black
- Unit: mm

MOUNTING HOLE Ø3.0
THICKNESS 1.6

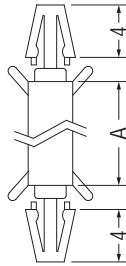

MOUNTING HOLE Ø3.0
THICKNESS 1.6

Part No.	A	Package
LCA-6	6.3	1000
LCA-8	8.0	
LCA-10	10.0	
LCA-11	11.0	
LCA-12	12.7	
LCA-12	12.7	

MOUNTING HOLE Ø3.0
THICKNESS 0.8-2.0

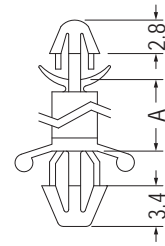

MOUNTING HOLE Ø4.0
THICKNESS 1.2-2.6

Part No.	A	Package
LCH-3	3.5	1000
LCH-4	4.0	
LCH-5	5.0	
LCH-6	6.3	
LCH-7	7.4	
LCH-8	8.5	
LCH-10	10.0	
LCH-11	11.0	
LCH-12	12.7	
LCH-15	15.9	

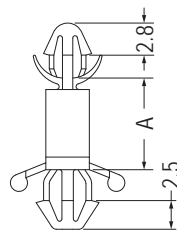
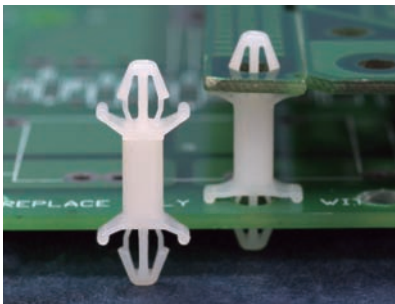
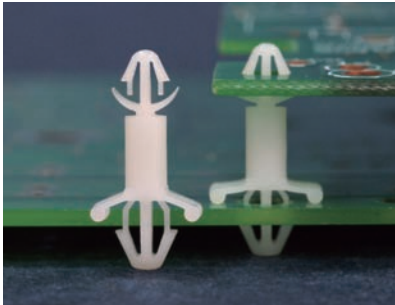

MOUNTING HOLE Ø3.0
THICKNESS 0.7-1.6

MOUNTING HOLE Ø4.0
THICKNESS 0.8-2.5

Part No.	A	Package
LCH-8S	8.0	1000
LCH-10S	10.0	
LCH-15S	13.0	

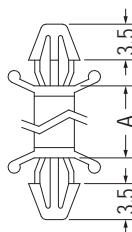

MOUNTING HOLE Ø3.5
THICKNESS 0.8-2.0

MOUNTING HOLE Ø3.5
THICKNESS 0.8-2.0

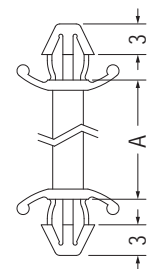

MOUNTING HOLE Ø4.0
THICKNESS 1.6

MOUNTING HOLE Ø4.0
THICKNESS 1.6

MOUNTING HOLE Ø3.5
THICKNESS 0.8-2.0

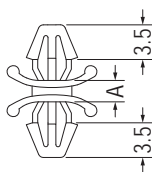

MOUNTING HOLE Ø3.5
THICKNESS 0.8-2.0

【 CBSS-2S 】

Part No.	A	Package
CBSS-2	2.1	2000
CBSS-2S	2.1	
CBSS-2.2	2.2	
CBSS-4.8	4.8	
CBSS-7	7.0	
CBSS-10	10.0	
CBSS-12.7	12.7	
CBSS-14	14.0	
CBSS-17	17.0	

Part No.	A	Package
CBLSS-6	4.2	1000
CBLSS-8	6.2	
CBLSS-10	8.2	
CBLSS-12	10.2	
CBLSS-13	11.2	
CBLSS-14	12.2	
CBLSS-16	14.2	
CBLSS-16.8	15.0	
CBLSS-18	16.2	
CBLSS-20	18.2	
CBLSS-42	40.2	

PC板間隔柱 SPACER SUPPORT

用途：固定PC板於機板上，免工具易拆卸。

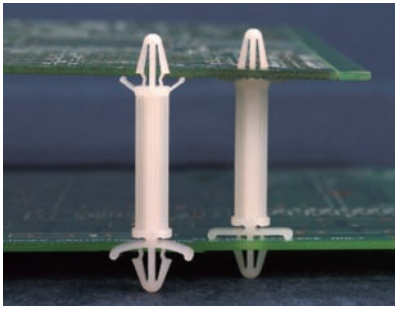

- Material: Nylon 66 (UL)
- Flame Class: 94V-2/94V-0
- Color: Natural/Black
- Unit: mm

MOUNTING HOLE Ø4.0
THICKNESS 0.8-1.7

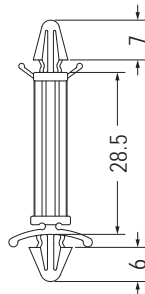

MOUNTING HOLE Ø4.8
THICKNESS 0.8-1.7

Part No.	Package
LCBSA-28.5	500

MOUNTING HOLE Ø4.0
THICKNESS 0.8-1.7

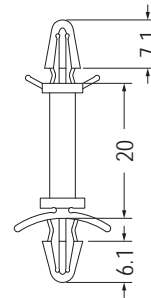

MOUNTING HOLE Ø4.8
THICKNESS 1.8-2.7

Part No.	Package
LCBSA-20L	500

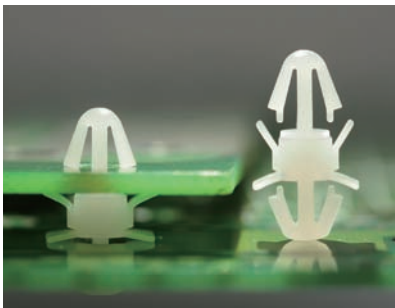

- Material: Nylon 66 (UL)
- Flame Class: 94V-2/94V-0
- Color: Natural/Black
- Unit: mm

用途：PC板與PC板間之固定，不佔空間。

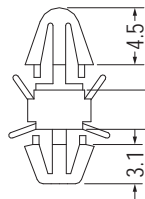

MOUNTING HOLE Ø4.0
THICKNESS 1.6

MOUNTING HOLE Ø4.0
THICKNESS 0.8

Part No.	Package
LCL-3.2	2000

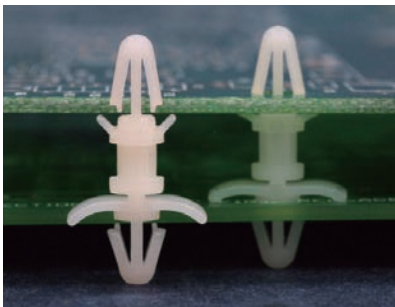

- Material: Nylon 66 (UL)
- Flame Class: 94V-2/94V-0
- Color: Natural/Black
- Unit: mm

用途：固定PC板於機板上，免工具易拆卸。

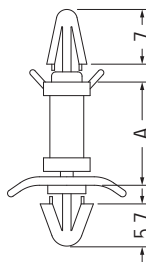

MOUNTING HOLE Ø4.0
THICKNESS 1.6

MOUNTING HOLE Ø4.8
THICKNESS 0.8-2.0

Part No.	A	Package
LCB-5	5.0	1000
LCB-6	6.3	
LCB-8	8.0	
LCB-10	10.0	
LCB-12	12.7	
LCB-15	15.9	
LCB-20	20.0	
LCB-25	25.0	

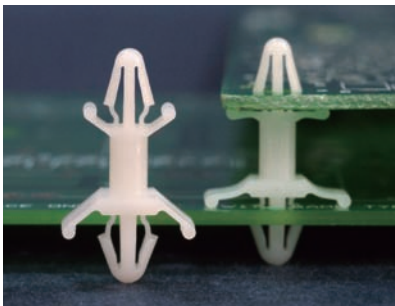

MOUNTING HOLE Ø4.0
THICKNESS 1.6

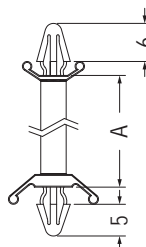

MOUNTING HOLE Ø4.0
THICKNESS 0.8-2.2

MOUNTING HOLE Ø4.0
THICKNESS 1.6

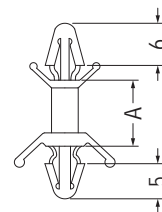

MOUNTING HOLE Ø4.8
THICKNESS 0.8-2.2

【CBSB-45】

Part No.	A	Package
CBS-3.8	3.8	1000
CBS-5	4.6	
CBS-6	6.3	
CBS-8	7.93	
CBS-9	9.2	
CBS-12	12.5	
CBS-15	15.7	
CBS-19	19.0	
CBS-22	22.0	
CBS-25	25.4	
CBS-28	28.6	
CBSB-45	45.0	

PC板間隔柱 SPACER SUPPORT

用途：固定PC板於機板上，免工具易拆卸。

1

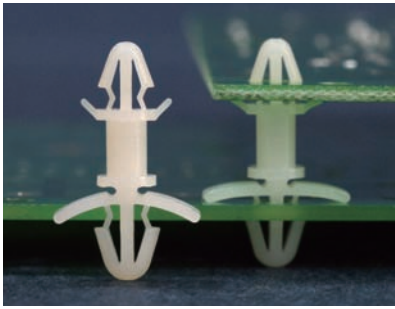

- Material: Nylon 66 (UL)
- Flame Class: 94V-2/94V-0
- Color: Natural/Black
- Unit: mm

MOUNTING HOLE $\varnothing 4.0$
THICKNESS 1.6

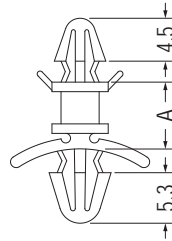

MOUNTING HOLE $\varnothing 4.8$
THICKNESS 0.8-2.2

Part No.	A	Package
LCBS-4	4.0	1000
LCBS-5	5.0	
LCBS-6	6.35	
LCBS-7	7.0	
LCBS-9	9.2	
LCBS-10	10.0	
LCBS-12	12.5	
LCBS-15	15.7	
LCBS-19	19.0	
LCBS-20	20.0	
LCBS-22	22.0	
LCBS-25	25.4	
LCBS-28	28.6	
LCBS-30	30.0	
LCBS-35	35.0	
LCBS-38	38.0	
LCBS-45	45.0	

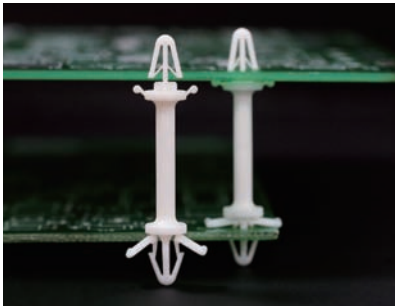

MOUNTING HOLE $\varnothing 4.0$
THICKNESS 1.6

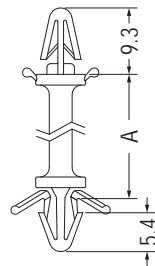

MOUNTING HOLE $\varnothing 4.8$
THICKNESS 2.0

Part No.	A	Package
LCBB-6.35	6.35	1000
LCBB-9.5	9.5	
LCBB-12.7	12.7	
LCBB-15.9	15.87	
LCBB-22.2	22.22	
LCBB-25.4	25.4	

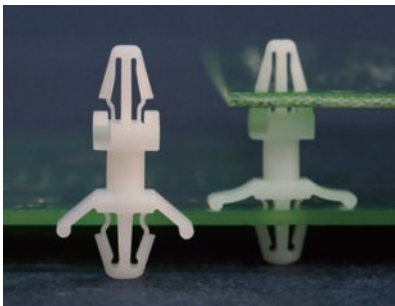

MOUNTING HOLE $\varnothing 4.0$
THICKNESS 1.2-2.0

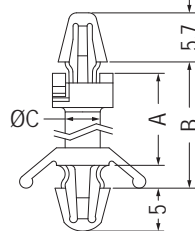

MOUNTING HOLE $\varnothing 4.8$
THICKNESS 0.8-2.0

Part No.	A	B	C	Package
VCBS-9	5.9	9.8		1000
VCBS-11	7.5	11.4	4.0	
VCBS-14	10.5	14.4	4.0	
VCBS-16	12.7	16.6	4.0	
VCBS-17	13.8	17.7	4.0	
VCBS-20	17.0	20.9	4.0	
VCBS-24	20.2	24.1	4.5	
VCBS-27	23.3	27.2	4.5	
VCBS-30	26.5	30.4	4.5	
VCBS-33	29.7	33.6	4.5	
VCBS-39	36.0	39.9	4.5	

MOUNTING HOLE $\varnothing 4.0$
THICKNESS 1.2-2.0

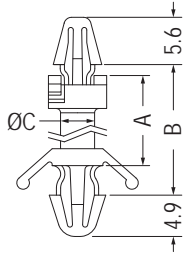

MOUNTING HOLE $\varnothing 4.8$
THICKNESS 0.8-3.0

Part No.	A	B	C	Package
VCBSL-9	5.0	9.8		1000
VCBSL-11	6.6	11.4	4.0	
VCBSL-14	9.6	14.4	4.0	
VCBSL-16	11.8	16.6	4.0	
VCBSL-17	12.9	17.7	4.0	
VCBSL-24	19.3	24.1	4.5	
VCBSL-27	22.4	27.2	4.5	
VCBSL-30	25.6	30.4	4.5	
VCBSL-33	28.8	33.6	4.5	
VCBSL-39	35.1	39.9	4.5	

PC板間隔柱 SPACER SUPPORT

用途：固定PC板於機板上，免工具易拆卸。

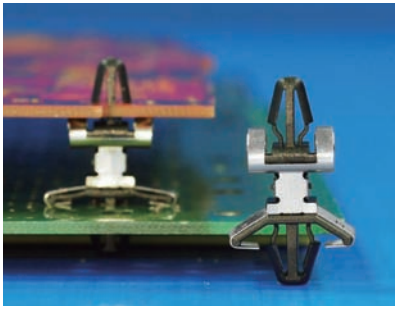

- Material: Nylon 66 (UL)
- Flame Class: 94V-2/94V-0
- Color: Natural/Black
- Unit: mm

MOUNTING HOLE $\varnothing 4.0$
THICKNESS 1.6-2.0

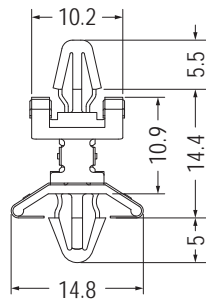

MOUNTING HOLE $\varnothing 4.8$
THICKNESS 1.0-2.0

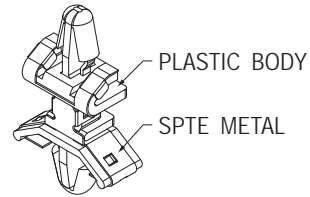

Part No.	Part No.	Package
VCBA-14.4F	VCBA-14.4ST	1000
	VCBA-14.4	

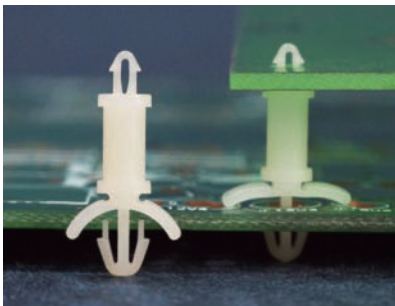

MOUNTING HOLE $\varnothing 2.0$
THICKNESS 1.6

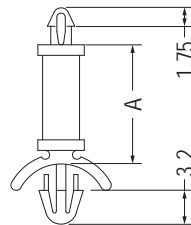

MOUNTING HOLE $\varnothing 3.0$ - $\varnothing 3.2$
THICKNESS 0.8-2.0

Part No.	A	Package
LCMA-3.2	3.2	1000
LCMA-4.8	4.8	
LCMA-6.4	6.4	
LCMA-7.9	7.9	
LCMA-9.5	9.5	
LCMA-11.1	11.1	
LCMA-12.7	12.7	
LCMA-14.3	14.3	
LCMA-15.9	15.9	
LCMA-17	17.0	

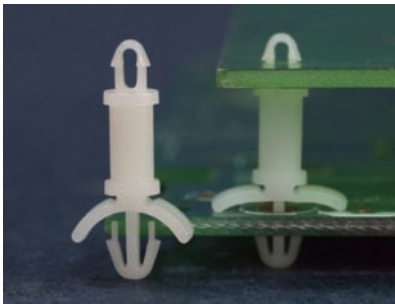

MOUNTING HOLE $\varnothing 2.5$
THICKNESS 1.6

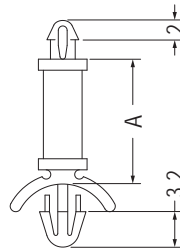

MOUNTING HOLE $\varnothing 3.0$ - $\varnothing 3.2$
THICKNESS 0.8-2.0

Part No.	A	Package
LCMD-3.2	3.2	1000
LCMD-4.8	4.8	
LCMD-6.4	6.4	
LCMD-7.9	7.9	
LCMD-9.5	9.5	
LCMD-11.1	11.1	
LCMD-12.7	12.7	
LCMD-14.3	14.3	
LCMD-15.9	15.9	
LCMD-17	17.0	

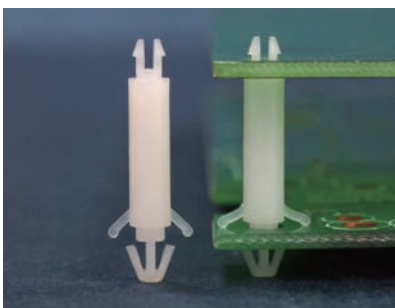

- Material: Nylon 66 (UL)
- Flame Class: 94V-2/94V-0
- Color: Natural/Black
- Unit: mm

用途：PC板與PC板間之固定，不佔空間。

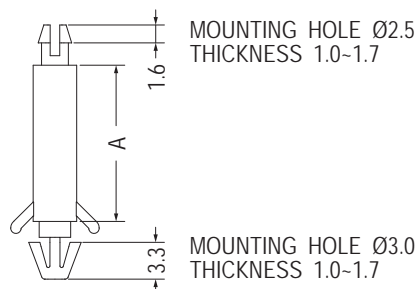

MOUNTING HOLE $\varnothing 2.5$
THICKNESS 1.0-1.7

MOUNTING HOLE $\varnothing 3.0$
THICKNESS 1.0-1.7

Part No.	A	Package
LCAB-12	12.0	1000
LCAB-14	14.0	

PC板間隔柱 SPACER SUPPORT

用途：固定PC板於機板上，免工具易拆卸。

1

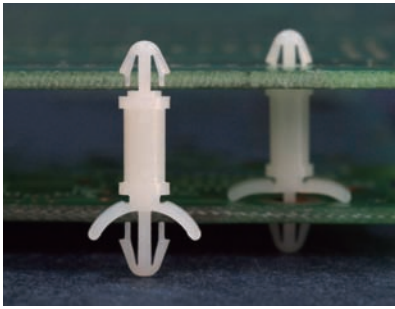

- Material: Nylon 66 (UL)
- Flame Class: 94V-2/94V-0
- Color: Natural/Black
- Unit: mm

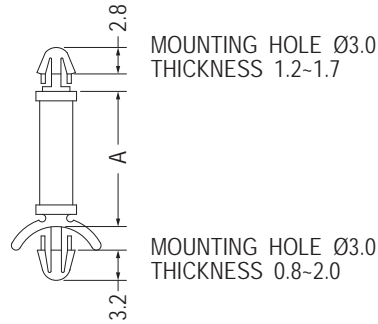

Part No.	A	Package
LCG-3	3.2	1000
LCG-5	4.8	
LCG-6	6.4	
LCG-8	7.9	
LCG-9	9.5	
LCG-11	11.1	
LCG-12	12.7	
LCG-14	14.3	
LCG-15	15.9	
LCG-17	17.0	
LCG-18	18.0	
LCG-19	19.0	
LCG-20	20.0	
LCG-26	26.0	

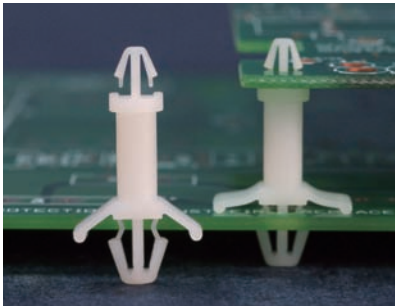

MOUNTING HOLE Ø3.0
THICKNESS 1.2-1.7

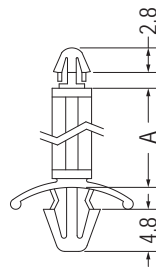

MOUNTING HOLE Ø3.5
THICKNESS 1.2-1.7

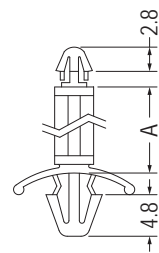

MOUNTING HOLE Ø3.0
THICKNESS 1.4-1.6

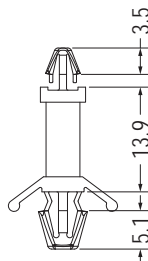

MOUNTING HOLE Ø4.8-Ø5.0
THICKNESS 0.8-2.0

Part No.	Package
LCBUA-13.9	1000

MOUNTING HOLE Ø4.8
THICKNESS 0.8-2.2

Part No.	A	Package
LCBT-3	3.2	1000
LCBT-5	4.8	
LCBT-6	6.3	
LCBT-8	8.0	
LCBT-10	10.0	
LCBT-12	12.0	
LCBT-14	14.0	
LCBT-16	16.0	
LCBT-18	18.0	
LCBT-25	25.0	

MOUNTING HOLE Ø4.8
THICKNESS 0.8-2.2

Part No.	A	Package
LCBU-3	3.2	1000
LCBU-5	5.0	
LCBU-6	6.3	
LCBU-8	8.0	
LCBU-10	10.0	
LCBU-12	12.0	
LCBU-14	14.0	
LCBU-16	16.0	
LCBU-18	18.0	
LCBU-25	25.0	

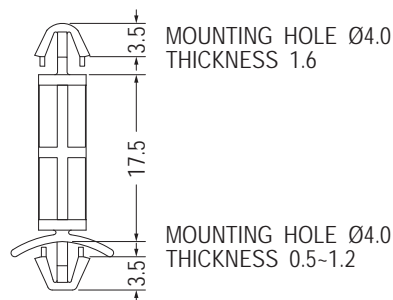
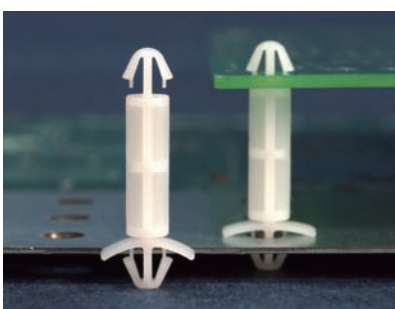

Part No.	Package
LCGB-17.5	1000

PC板間隔柱 SPACER SUPPORT

用途：固定PC板於機板上，免工具易拆卸。

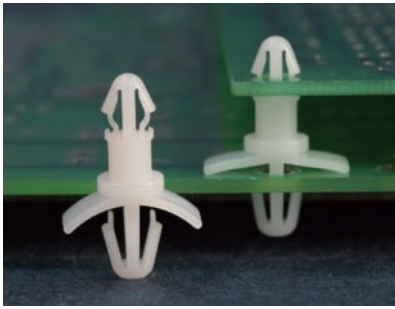

- Material: Nylon 66 (UL)
- Flame Class: 94V-2/94V-0
- Color: Natural/Black
- Unit: mm

MOUNTING HOLE Ø4.0
THICKNESS 1.6

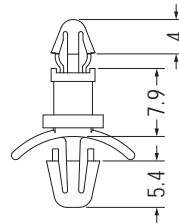

MOUNTING HOLE Ø4.8
THICKNESS 0.8-2.0

Part No.	Package
LCBC-8	1000

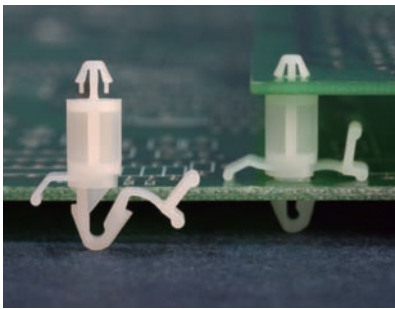

- Material: Nylon 66 (UL)
- Flame Class: 94V-2/94V-0
- Color: Natural/Black
- Unit: mm

用途：PC板與PC板間之固定，不佔空間，可在板上拆卸。

MOUNTING HOLE Ø3.0
THICKNESS 1.6

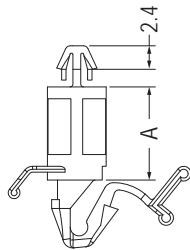

MOUNTING HOLE Ø4.8
THICKNESS 0.8-1.6

Part No.	A	Package
KLCBS-9.5	9.5	1000
KLCBS-12.7	12.7	
KLCBS-15.9	15.9	
KLCBS-19.1	19.1	

MOUNTING HOLE Ø3.5
THICKNESS 1.6

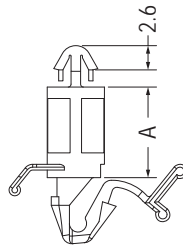

MOUNTING HOLE Ø4.8
THICKNESS 0.8-1.6

Part No.	A	Package
KLCBM-9.5	9.5	1000
KLCBM-12.7	12.7	
KLCBM-15.9	15.9	
KLCBM-19.1	19.1	

MOUNTING HOLE Ø4.0
THICKNESS 1.6

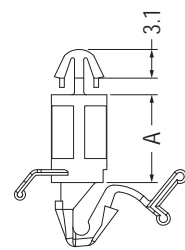

MOUNTING HOLE Ø4.8
THICKNESS 0.8-1.6

Part No.	A	Package
KLCBL-9.5	9.5	1000
KLCBL-12.7	12.7	
KLCBL-15.9	15.9	
KLCBL-19.1	19.1	

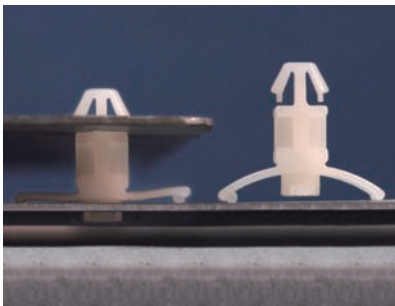

- Material: Nylon 66 (UL)
- Flame Class: 94V-2/94V-0
- Color: Natural/Black
- Unit: mm

MOUNTING HOLE Ø4.0
THICKNESS 1.0

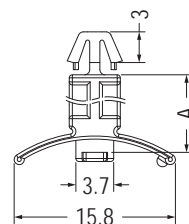

MOUNTING HOLE
THICKNESS 0.6-1.0

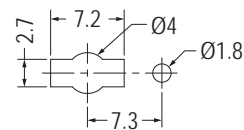

Part No.	A	Package
LCBA-5.6	5.6	1000
LCBA-7.6	7.6	

PC板間隔柱 SPACER SUPPORT

用途：固定PC板於機板上，免工具易拆卸。

- Material: Nylon 66 (UL)
- Flame Class: 94V-2/94V-0
- Color: Natural/Black
- Unit: mm

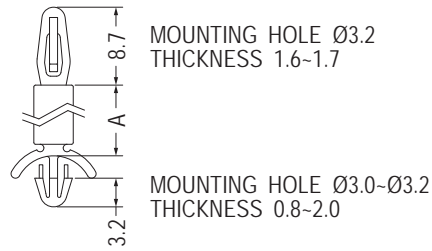
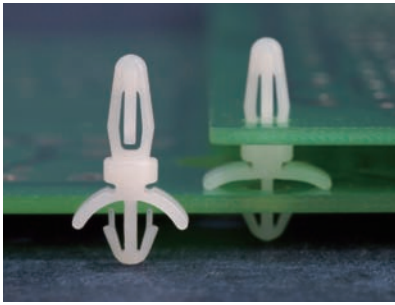

Part No.	A	Package
LCSE-3.2	3.2	1000
LCSE-4.8	4.8	
LCSE-6.4	6.4	
LCSE-7.9	7.9	
LCSE-9.5	9.5	
LCSE-11.1	11.1	
LCSE-12.7	12.7	
LCSE-14.3	14.3	
LCSE-15.9	15.9	
LCSE-17	17.0	

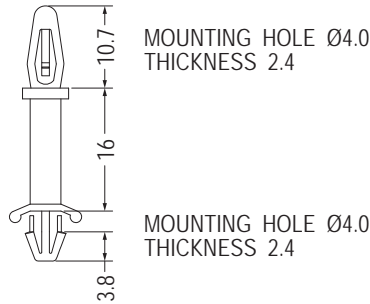
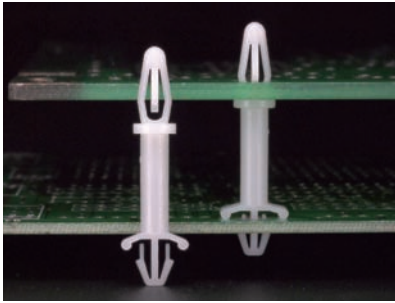

Part No.	Package
LCSJ-16	1000

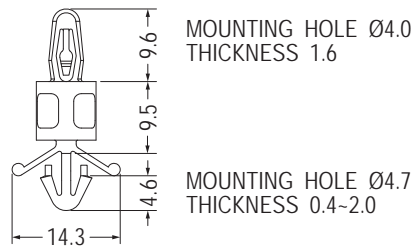
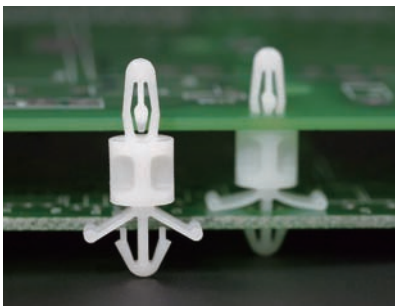

Part No.	Package
LCSH-9.5	1000

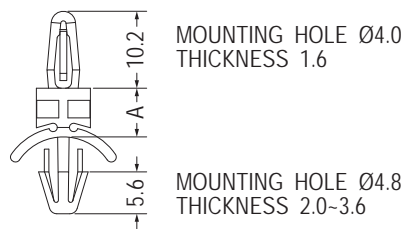
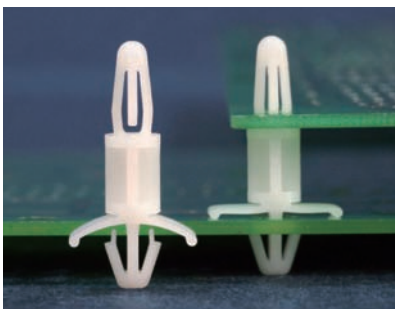

Part No.	A	Package
LCSA-6.4	6.4	1000
LCSA-9.5	9.5	

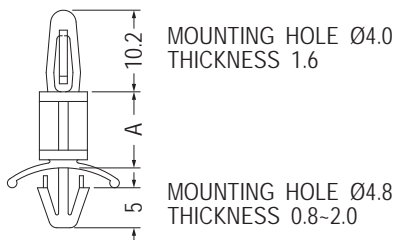

Part No.	A	Package
LCS-3	3.5	1000
LCS-5	4.8	
LCS-6	6.0	
LCS-6A	6.4	
LCS-8	7.9	
LCS-9	9.5	

Part No.	A	Package
LCS-11	11.1	1000
LCS-12	12.7	
LCS-16	15.9	
LCS-19	19.1	
LCS-22	22.2	
LCS-24	24.0	
LCS-25	25.4	
LCS-27.5	27.5	
LCS-28	28.6	
LCS-31.1	31.1	
LCS-31.7	31.7	
LCS-35	34.9	

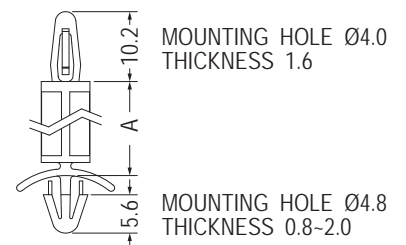

Part No.	A	Package
HLCS-4.8	4.8	1000
HLCS-6.4	6.4	
HLCS-9.5	9.5	
HLCS-12.7	12.7	
HLCS-15.9	15.9	
HLCS-25.4	25.4	
HLCS-40	40.0	500
HLCS-49	49.0	

PC板間隔柱 SPACER SUPPORT

用途：固定PC板於機板上，免工具易拆卸。

- Material: Nylon 66 (UL)
- Flame Class: 94V-2/94V-0
- Color: Natural/Black
- Unit: mm

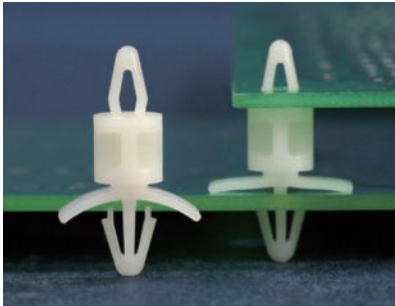
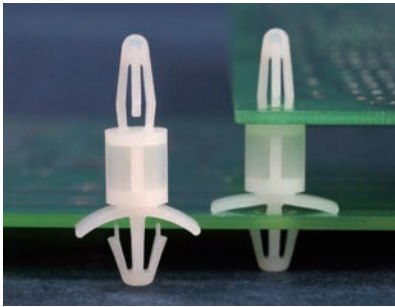

MOUNTING HOLE Ø4.0
THICKNESS 2.4

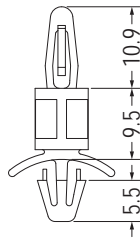

MOUNTING HOLE Ø4.8
THICKNESS 1.6

Part No.	Package
LCSLR-9.5	1000

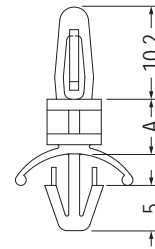

MOUNTING HOLE Ø4.0
THICKNESS: T

MOUNTING HOLE Ø4.8
THICKNESS 2.0-3.2

Part No.	A	T	Package
LCSD-4.8	4.8	1.6	1000
LCSD-9.5	9.5	1.6	
LCSD-12.7	12.7	1.6	
LCSL-4.8	4.8	2.0-3.2	

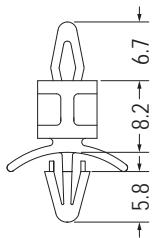

MOUNTING HOLE Ø3.5
THICKNESS 1.6

MOUNTING HOLE Ø4.0
THICKNESS 0.8-1.6

Part No.	Package
LCPA-8.2	1000

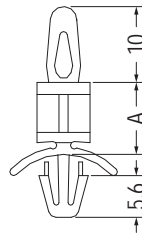

MOUNTING HOLE Ø4.0
THICKNESS 1.2-1.7

MOUNTING HOLE Ø4.8
THICKNESS 0.8-2.5

Part No.	A	Package
LCP-7.9	7.9	1000
LCP-9	9.5	
LCP-12.7	12.7	
LCP-22	22.2	

MOUNTING HOLE Ø4.0
THICKNESS 1.2-1.7

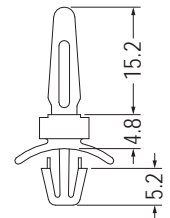

MOUNTING HOLE Ø4.8
THICKNESS 0.8-2.0

Part No.	Package
LCY-4.8	1000

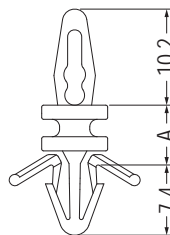
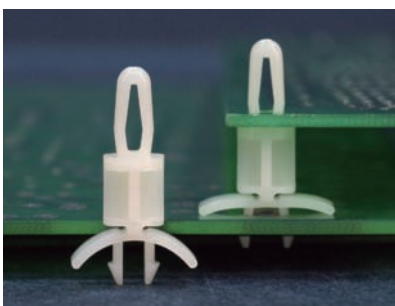
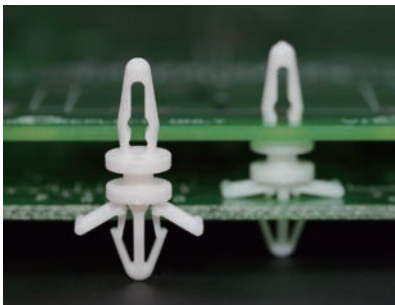

MOUNTING HOLE Ø4.0
THICKNESS 1.6

MOUNTING HOLE Ø4.8
THICKNESS 2.0

Part No.	A	Package
LCPD-6.35	6.35	1000
★LCPD-9.5	9.52	

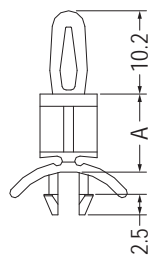

MOUNTING HOLE Ø4.0
THICKNESS 1.2-1.7

MOUNTING HOLE Ø4.8
THICKNESS 0.8-2.0

Part No.	A	Package
UCBS-5	4.8	1000
UCBS-6	6.4	
UCBS-9	9.5	
UCBS-12	12.7	
UCBS-15	15.9	
UCBS-19	19.1	
UCBS-22	22.2	

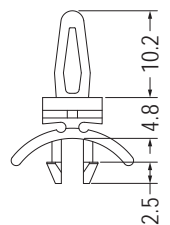

MOUNTING HOLE Ø3.8
THICKNESS 1.6

MOUNTING HOLE Ø4.8
THICKNESS 0.8-2.0

Part No.	Package
UCBS-5A	1000

PC板間隔柱 SPACER SUPPORT

用途：固定PC板於機板上，免工具易拆卸。

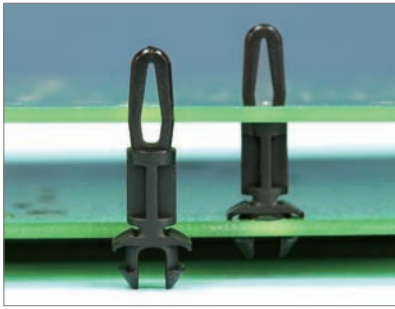

- Material: Nylon 66 (UL)
- Flame Class: 94V-2/94V-0
- Color: Natural/Black
- Unit: mm

MOUNTING HOLE Ø4.0
THICKNESS 1.2-1.7

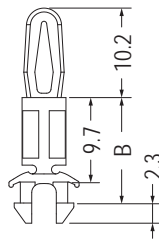

MOUNTING HOLE Ø5.4
THICKNESS: T

Part No.	B	T	Package
UCBSL-9	11.7	1.6	1000
UCBSL-10	12.0	2.2	

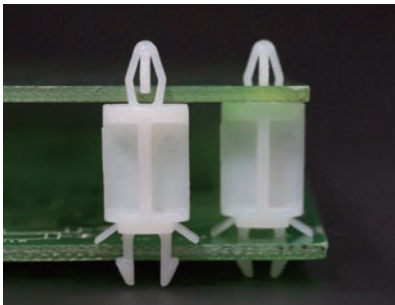

MOUNTING HOLE Ø3.3
THICKNESS 1.6

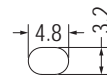
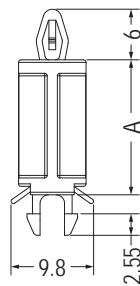

MOUNTING HOLE
THICKNESS 1.8-2.0

Part No.	A	Package
LMSD-12	12.0	1000
LMSD-16	16.0	

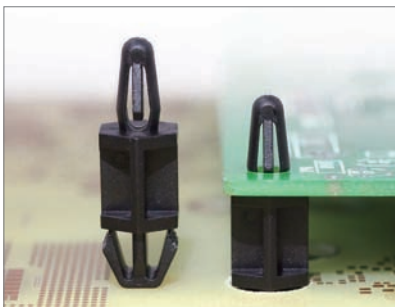

MOUNTING HOLE Ø4.0
THICKNESS 1.6

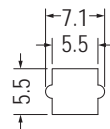
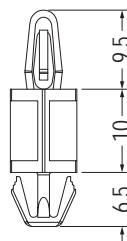

MOUNTING HOLE
THICKNESS 0.8-1.6

Part No.	Package
LCSI-10	1000

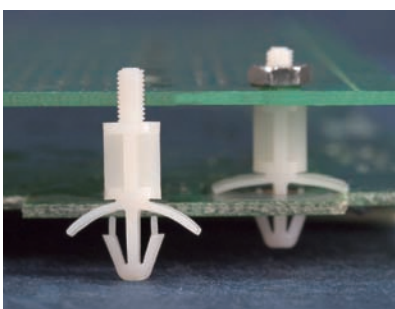

- Material: Nylon 66 (UL)
- Flame Class: 94V-2/94V-0
- Color: Natural/Black
- Unit: mm

用途：固定PC板於機板上，一頭配合螺母使用，不旋轉。

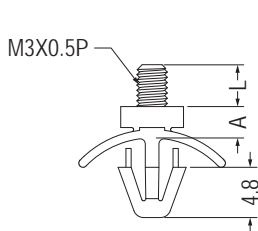

【 LCDS3-3, LCDS3-4 】

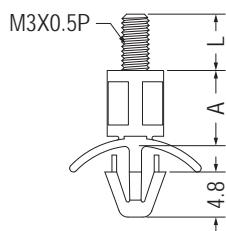

MOUNTING HOLE Ø4.8
THICKNESS 0.8-2.5

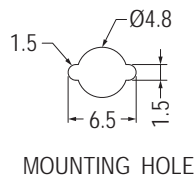

MOUNTING HOLE

Part No.	A	L	Package
LCDS3-3	3.0	4.0	1000
LCDS3-4	4.0	4.0	
LCDS3-5	5.0	4.0	
LCDS3-6	6.0	6.0	
LCDS3-7	7.0	6.0	
LCDS3-8	8.0	6.0	
LCDS3-9	9.0	6.0	
LCDS3-10	10.0	6.0	
LCDS3-11	11.0	6.0	
LCDS3-12	12.0	6.0	
LCDS3-13	13.0	6.0	
LCDS3-14	14.0	6.0	
LCDS3-15	15.0	6.0	

PC板間隔柱 SPACER SUPPORT

用途：固定PC板於機板上，一頭配合螺母使用，不旋轉。

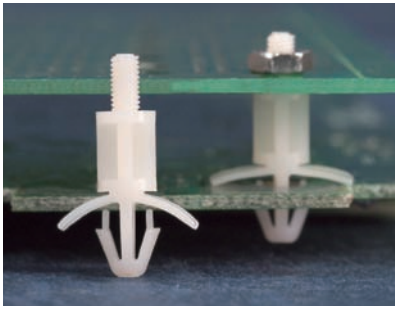

- Material: Nylon 66 (UL)
- Flame Class: 94V-2/94V-0
- Color: Natural/Black
- Unit: mm

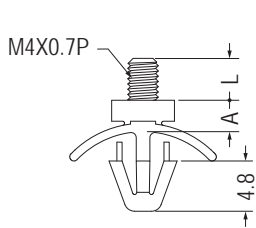

【 LCDS4-3, LCDS4-4 】

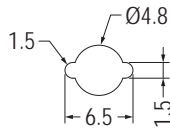
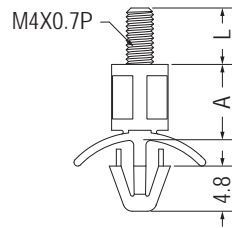

MOUNTING HOLE THICKNESS 0.8-2.5

Part No.	A	L	Package
LCDS4-3	3.0	4.0	1000
LCDS4-4	4.0	4.0	
LCDS4-5	5.0	4.0	
LCDS4-6	6.0	6.0	
LCDS4-7	7.0	6.0	
LCDS4-8	8.0	6.0	
LCDS4-9	9.0	6.0	
LCDS4-10	10.0	6.0	
LCDS4-11	11.0	6.0	
LCDS4-12	12.0	6.0	
LCDS4-13	13.0	6.0	
LCDS4-14	14.0	6.0	
LCDS4-15	15.0	6.0	

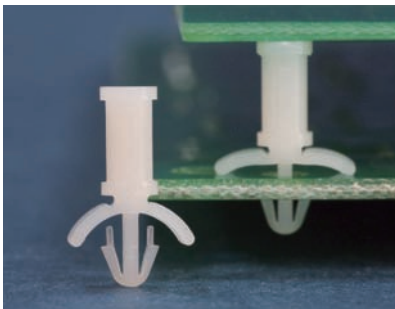

- Material: Nylon 66 (UL)
- Flame Class: 94V-2/94V-0
- Color: Natural/Black
- Unit: mm

用途：一端固定於機板上，另一端支撐PC板，避免下陷造成短路，PC板免鑽孔。

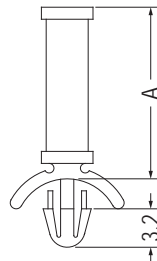

MOUNTING HOLE Ø3.0 THICKNESS 0.8-2.0

Part No.	A	Package
LBS-3	3.2	1000
LBS-5	4.8	
LBS-6	6.4	
LBS-8	7.9	
LBS-9	9.5	
LBS-11	11.1	
LBS-12	12.7	
LBS-14	14.3	
LBS-15	15.9	
LBS-17	17.0	
LBS-19	19.0	
LBS-20	20.0	
LBS-26	26.0	

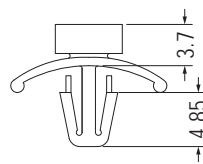
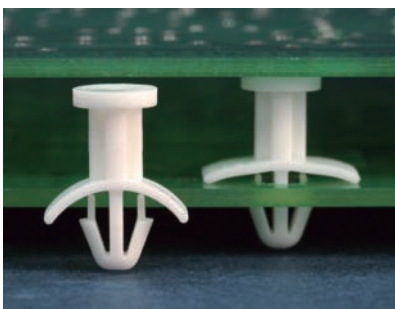

MOUNTING HOLE Ø4.0 THICKNESS 1.0-2.0

Part No.	Package
LASB-3.7	1000

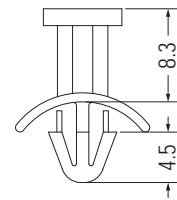

MOUNTING HOLE Ø4.5 THICKNESS 0.8-2.0

Part No.	Package
LASD-8.3	1000

PC板間隔柱 SPACER SUPPORT

1

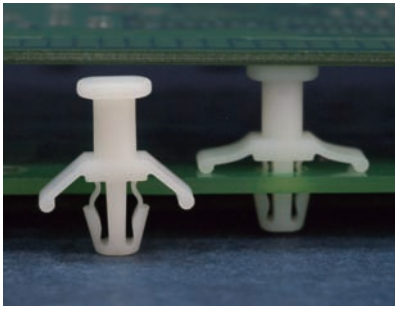

- Material: Nylon 66 (UL)
- Flame Class: 94V-2/94V-0
- Color: Natural/Black
- Unit: mm

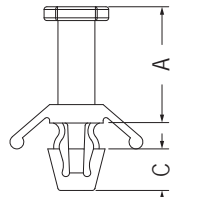

MOUNTING HOLE Ø4.8
THICKNESS: T

Part No.	A	C	T	Package
LASY-4.6	4.6	4.6	0.8~2.5	1000
LASY-9.3	9.3	4.5	0.5~2.3	
LASY-12.6	12.6	4.5	0.5~2.3	
LASY-15.9	15.9	4.5	0.5~2.3	

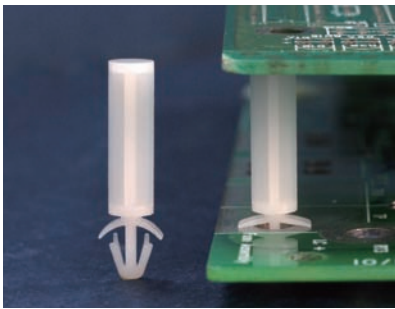
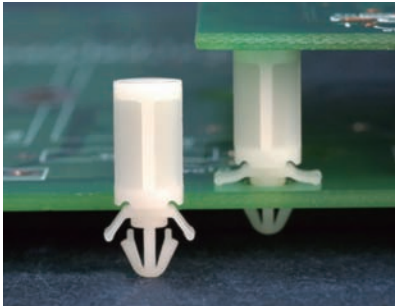

用途：一端固定於機板上，另一端支撐PC板，避免下陷造成短路，PC板免鑽孔。

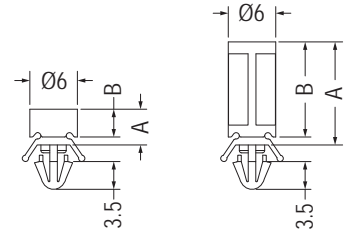

【LASE-4.5】 MOUNTING HOLE Ø3.5
THICKNESS 1.2-1.6

Part No.	A	B	Package
LASE-4.5	4.5	3.5	1000
LASE-7	7.0	6.0	
LASE-12	12.0	11.0	

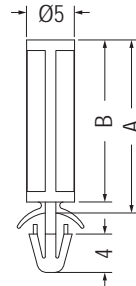

MOUNTING HOLE Ø3.5
THICKNESS 1.6

Part No.	A	B	Package
LASJ-17	17.0	15.9	1000
LASJ-18	18.0	16.9	
LASJ-20	20.0	18.9	

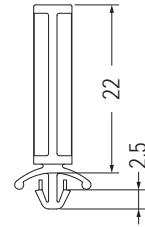

MOUNTING HOLE Ø3.5
THICKNESS 0.8-1.8

Part No.	Package
LASH-22	1000

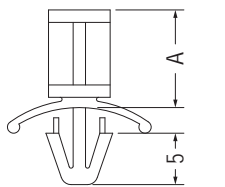

MOUNTING HOLE Ø4.8
THICKNESS 0.8-2.0

Part No.	A	Package
LAS-3	3.5	1000
LAS-5	4.8	
LAS-6	6.0	
LAS-6A	6.4	
LAS-8	7.9	
LAS-9	9.5	
LAS-11	11.1	
LAS-12	12.7	
LAS-16	15.9	

Part No.	A	Package
LAS-19	19.1	1000
LAS-22	22.2	
LAS-24	24.0	
LAS-25	25.4	
LAS-27.5	27.5	
LAS-28	28.6	500
LAS-31.1	31.1	
LAS-31.7	31.7	
LAS-35	34.9	

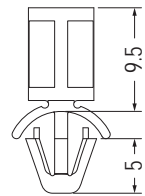

MOUNTING HOLE Ø4.8-Ø5.0
THICKNESS 0.8-2.0

Part No.	Package
LASA-9.5	1000

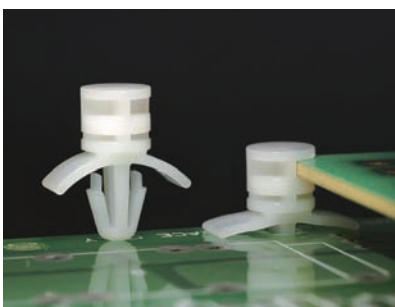

- Material: Nylon 66 (UL)
- Flame Class: 94V-2/94V-0
- Color: Natural/Black
- Unit: mm

用途：一端固定於機板上，另一端卡於PC板內。

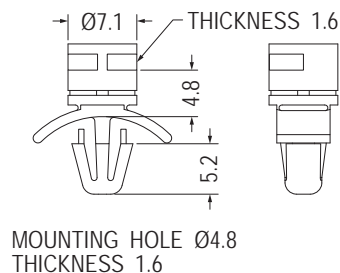
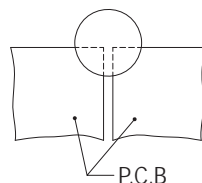

MOUNTING HOLE Ø4.8
THICKNESS 1.6

NEW

Part No.	Package
LASL-4.8	1000

PC板間隔柱 SPACER SUPPORT

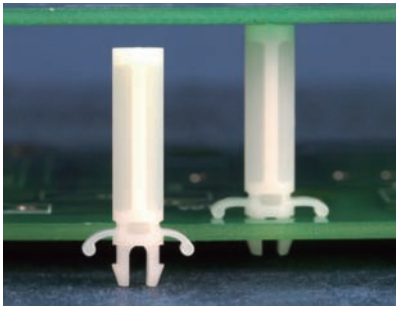

- Material: Nylon 66 (UL)
- Flame Class: 94V-2/94V-0
- Color: Natural/Black
- Unit: mm

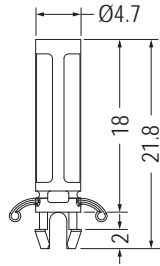

MOUNTING HOLE Ø4.0
THICKNESS 1.2-1.6

Part No.	Package
LASF-18	1000

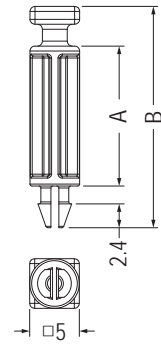
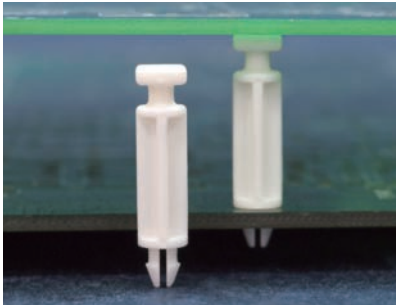

MOUNTING HOLE Ø3.0
THICKNESS 1.6

Part No.	A	B	Package
MSA-14.1	14.1	22.3	1000
MSA-24.3	24.3	32.5	

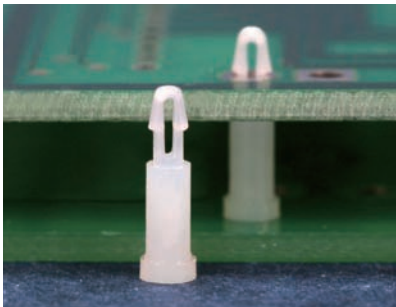

- Material: Nylon 66 (UL)
- Flame Class: 94V-2/94V-0
- Color: Natural/Black
- Unit: mm

MOUNTING HOLE Ø1.5
THICKNESS 1.0

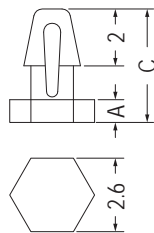

Part No.	A	C	Package
MASD-0.8	0.8	4.0	2000
MASD-2	2.0	5.2	

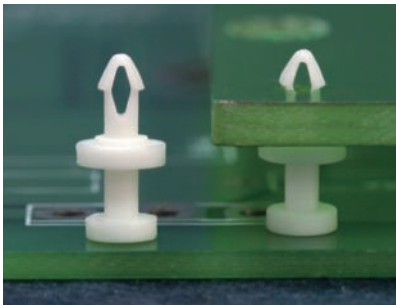

MOUNTING HOLE Ø1.5
THICKNESS 1.6

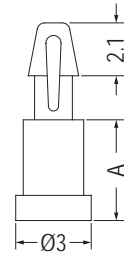

Part No.	A	Package
MASS-2	2.0	2000
MASS-2.5	2.5	
MASS-3	3.0	
MASS-3.5	3.5	
MASS-4	4.0	
MASS-5	5.0	
MASS-6	6.0	
MASS-6.5	6.5	

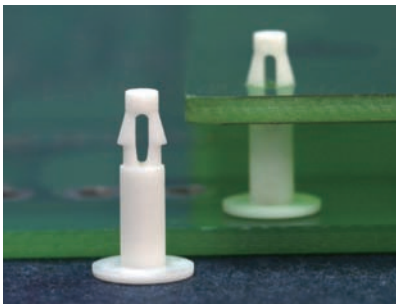

MOUNTING HOLE Ø2.0
THICKNESS 1.6

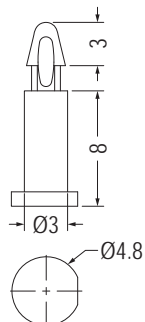

Part No.	Package
MAL-8	1000

MOUNTING HOLE Ø2.0
THICKNESS 2.4

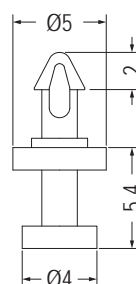

Part No.	Package
MASL-5.4	1000

MOUNTING HOLE Ø2.0
THICKNESS: T

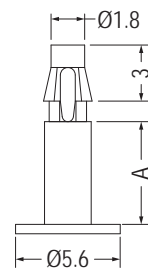

Part No.	A	T	Package
MAST-6	5.5	1.0	1000
MAST-18	18.3	1.6	

PC板間隔柱 SPACER SUPPORT

用途：支撐PC板，使中間不致震動，載重而凹陷短路。

- Material: Nylon 66 (UL)
- Flame Class: 94V-2/94V-0
- Color: Natural/Black
- Unit: mm

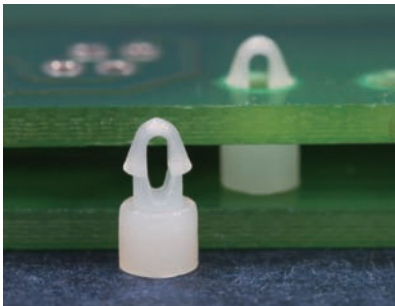
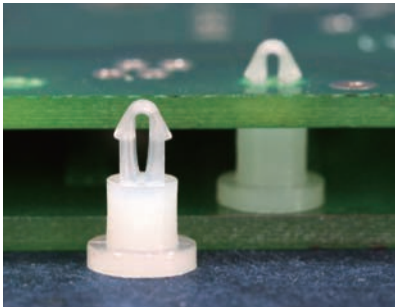
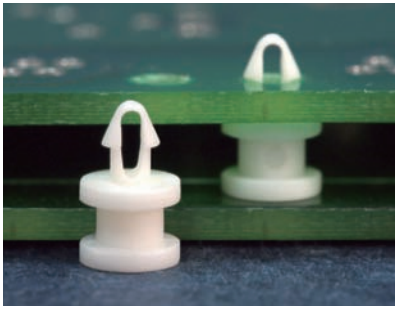

MOUNTING HOLE Ø2.0
THICKNESS 1.4

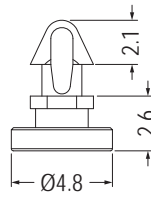

Part No.	Package
MABA-2.6	2000

MOUNTING HOLE Ø2.0
THICKNESS 1.6

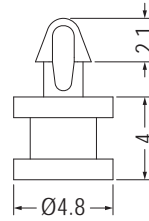

Part No.	Package
MAB-4	1000

MOUNTING HOLE Ø2.0
THICKNESS 1.0

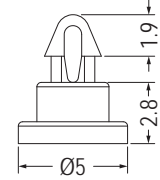

Part No.	Package
MA-2.8S	2000

MOUNTING HOLE Ø2.0
THICKNESS 1.6

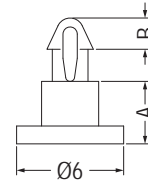

Part No.	A	B	Package
MA-2.7DL	2.7	1.9	2000
MA-3.5DL	3.5	1.75	
MA-3.85DL	3.85	1.9	
MA-4.5DL	4.5	1.9	
MA-5DL	5.0	1.9	
MA-6.5DL	6.5	1.9	

MOUNTING HOLE Ø2.0
THICKNESS 1.0

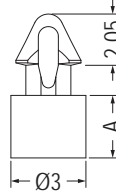

Part No.	A	Package
MA-2.5S	2.5	2000
MA-3S-1	3.0	

MOUNTING HOLE Ø2.0
THICKNESS: T

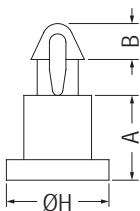

Part No.	A	B	H	T	Package
MA-1.8	1.8	1.9	4.2	1.6	2000
MA-2	2.0	1.9	4.2	1.6	
MA-2L	2.0	2.05	4.8	2.0	
MA-2.5	2.5	1.9	4.1	1.6	
MA-2.5L	2.5	2.0	4.8	1.6	
MA-3	3.0	1.9	4.8	1.6	
MA-3SA	3.0	1.8	4.2	1.6	
MA-3S	3.0	1.8	4.2	1.6	
MA-3.2	3.2	1.9	4.8	1.6	
MA-3.2-1	3.2	2.1	4.8	1.6	
MA-3.5	3.5	1.9	4.2	1.6	
MA-3.5L	3.5	2.0	4.8	1.6	
MA-3.75	3.75	2.0	4.8	1.6	
MA-4	4.0	1.9	4.8	1.6	
MA-4.5	4.5	1.9	4.2	1.6	
MA-4.7	4.7	1.9	4.8	1.6	
MA-5	5.0	1.9	4.8	1.6	
MA-5.6	5.6	2.0	4.2	1.6	
MA-6	6.0	1.9	5.0	1.6	
MA-6.5	6.5	1.9	5.0	1.6	
MA-6.75	6.75	1.9	5.0	1.6	
MA-8	8.0	1.9	5.0	1.6	
MA-9	9.0	1.9	5.0	1.6	

MOUNTING HOLE Ø2.5
THICKNESS 1.0

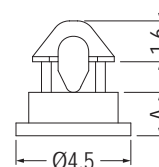

Part No.	A	Package
MAMS-1.5	1.5	2000
MAMS-1.7	1.7	
MAMS-5	5.0	

MOUNTING HOLE Ø2.5
THICKNESS 1.0

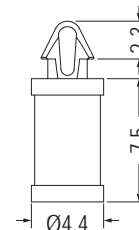

Part No.	Package
MAMS-7.5	1000

PC板間隔柱 SPACER SUPPORT

用途：支撐PC板，使中間不致震動，載重而凹陷短路。

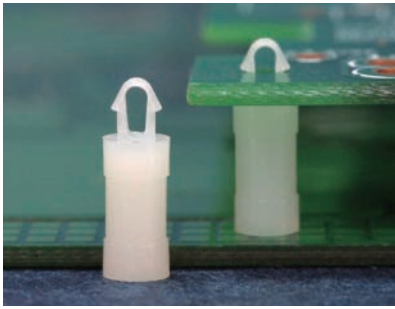

- Material: Nylon 66 (UL)
- Flame Class: 94V-2/94V-0
- Color: Natural/Black
- Unit: mm

MOUNTING HOLE $\varnothing 2.6$
THICKNESS 1.6

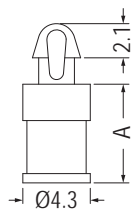

【 MAM-6.35L 】

MOUNTING HOLE $\varnothing 2.5$
THICKNESS 1.6

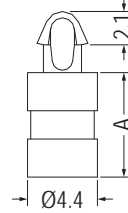

Part No.	A	Package
MAM-6.35L	6.35	2000
MAM-6.8	6.8	
MAM-7	7.0	
MAM-8	8.0	
MAM-8.4	8.4	
MAM-9	9.0	
MAM-9.5	9.5	
MAM-11	11.1	
MAM-12.7	12.7	
MAM-15.9	15.9	



MOUNTING HOLE $\varnothing 2.5$
THICKNESS 1.6~1.8

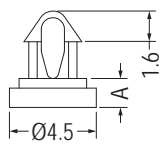

【 MAM-1.5L 】

MOUNTING HOLE $\varnothing 2.5$
THICKNESS 1.4~1.6

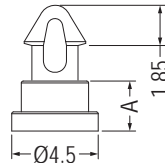

【 MAM-2.6 】

Part No.	A	Package
MAM-1.5	1.5	2000
MAM-1.5L	1.5	
MAM-2	2.0	
MAM-2.5	2.5	
MAM-2.6	2.6	
MAM-2.7	2.7	
MAM-3	3.0	
MAM-3.2	3.2	
MAM-3.5	3.5	
MAM-4	4.0	
MAM-4.5	4.5	
MAM-4.8	4.8	
MAM-5	5.0	
MAM-5.7	5.7	
MAM-6	6.0	
MAM-6.4	6.4	

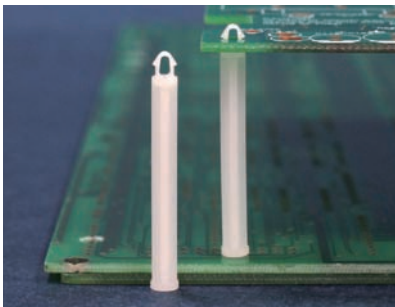

MOUNTING HOLE $\varnothing 2.5$
THICKNESS 1.6

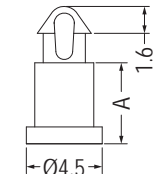

【 MAM-4.8, MAM-6.4 】

MOUNTING HOLE $\varnothing 2.5$
THICKNESS 1.6~1.8

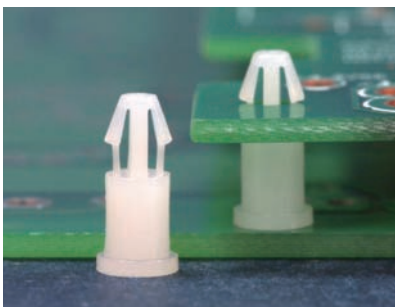
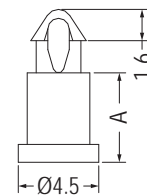

MOUNTING HOLE $\varnothing 3.0$
THICKNESS: T

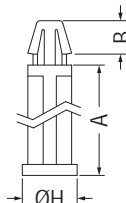

【 DCC-20S 】

MOUNTING HOLE $\varnothing 3.0$
THICKNESS: T

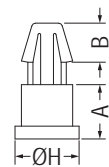

Part No.	A	B	H	T	Package
DCC-2	2.0	3.1	5.0	1.2~1.6	2000
DCC-2.5	2.5	3.1	5.0	1.2~1.6	
DCC-2.7	2.7	3.1	5.0	1.2~1.6	
DCC-3	3.0	3.1	5.0	1.2~1.6	
DCC-3.2	3.2	3.1	5.0	1.2~1.6	
DCC-3.5	3.5	3.1	5.0	1.2~1.6	
DCC-4	4.0	3.1	5.0	1.2~1.6	1000
DCC-4.5	4.5	3.1	5.0	1.2~1.6	
DCC-5	5.0	3.1	5.0	1.2~1.6	
DCC-5S	5.0	2.6	5.0	0.8~1.2	
DCC-5.5	5.5	3.1	5.0	1.2~1.6	
DCC-6	6.0	3.1	5.0	1.2~1.6	
DCC-6.2	6.2	3.1	5.0	1.2~1.6	
DCC-6.5	6.5	3.1	5.0	1.2~1.6	
DCC-9.5L	9.5	3.1	6.0	1.2~1.6	
DCC-20S	20.0	3.1	5.0	0.8	

MOUNTING HOLE $\varnothing 2.7$
THICKNESS 1.6

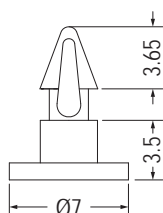

Part No.	Package
MAMA-3.5	1000

MOUNTING HOLE $\varnothing 3.0$
THICKNESS 1.6

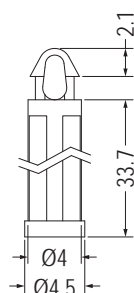

Part No.	Package
MAL-34	1000

PC板間隔柱 SPACER SUPPORT

用途：支撐PC板，使中間不致震動，載重而凹陷短路。

1

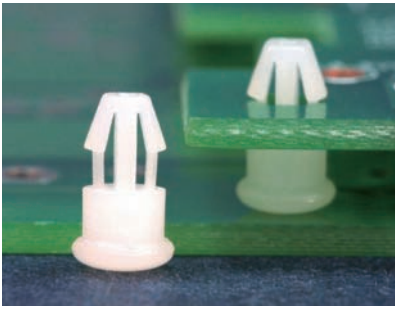

- Material: Nylon 66 (UL)
- Flame Class: 94V-2/94V-0
- Color: Natural/Black
- Unit: mm

MOUNTING HOLE $\varnothing 3.0$
THICKNESS 1.6

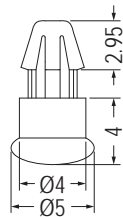

Part No.	Package
DCE-4	1000

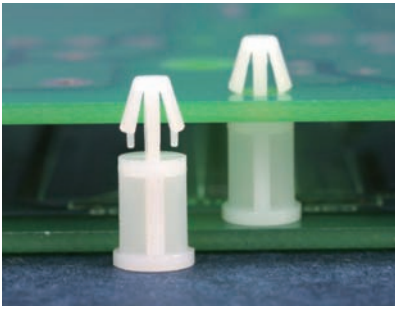

MOUNTING HOLE $\varnothing 3.5$
THICKNESS 0.8-1.6

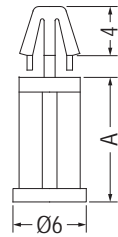

Part No.	A	Package
MCM-8	8.0	1000
MCM-14.5	14.5	



MOUNTING HOLE $\varnothing 3.7$
THICKNESS 1.6

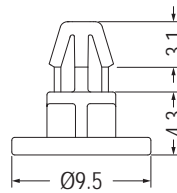

Part No.	Package
DCCA-4.3	1000

MOUNTING HOLE $\varnothing 4.0$
THICKNESS 1.2-1.6

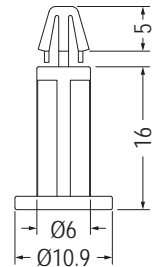

Part No.	Package
MCO-16	1000

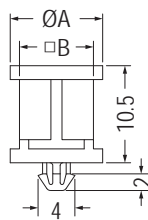
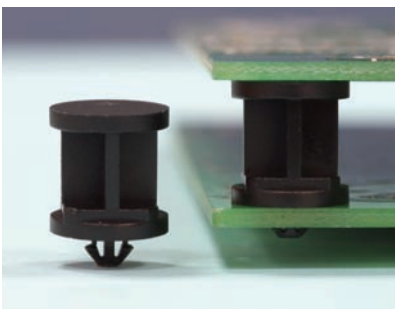

MOUNTING HOLE $\varnothing 3.0$
THICKNESS: T

Part No.	A	B	T	Package
TCBA-10.5S	7.5	6.0	1.0	1000
TCBA-10.5	10.0	8.0	1.0	
TCBA-10.5L	10.0	8.0	1.6	

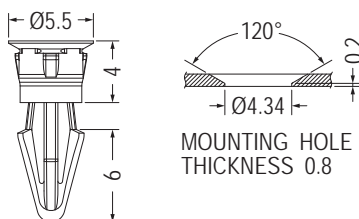

MOUNTING HOLE
THICKNESS 0.8

MOUNTING HOLE $\varnothing 3.0$ - $\varnothing 3.18$
THICKNESS 1.6

Part No.	Package
DCCB-4.1	1000

PC板間隔柱 SPACER SUPPORT

用途：支撐PC板，使中間不致震動，載重而凹陷短路。

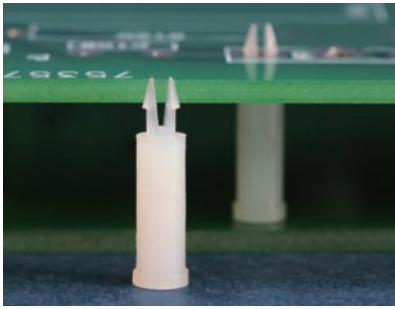

- Material: Nylon 66 (UL)
- Flame Class: 94V-0
- Color: Natural/Black
- Unit: mm

MOUNTING HOLE $\varnothing 2.0$
THICKNESS 1.2-1.8

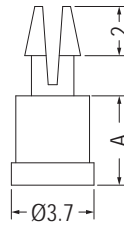

Part No.	A	Package
MS-4	4.0	2000
MS-5	5.0	
MS-10	10.0	

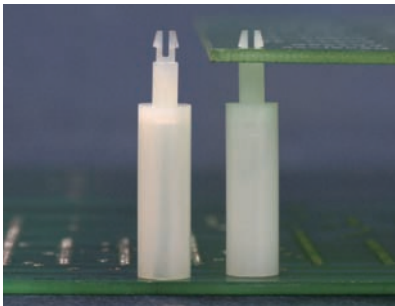

MOUNTING HOLE $\varnothing 2.2$
THICKNESS 1.6

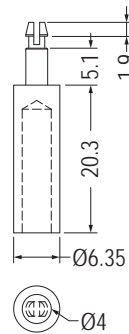

Part No.	Package
PCLS-25	1000

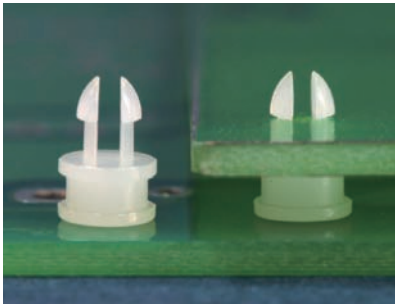

MOUNTING HOLE $\varnothing 2.3$
THICKNESS 1.6

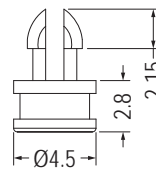

Part No.	Package
MSB-2.8	1000

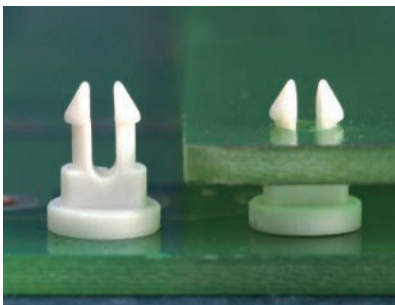

- Material: PBT (UL)
- Flame Class: 94V-0
- Color: Natural
- Unit: mm

MOUNTING HOLE $\varnothing 2.5$
THICKNESS 1.6

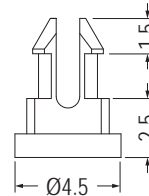

Part No.	Package
MSM-2.5	1000

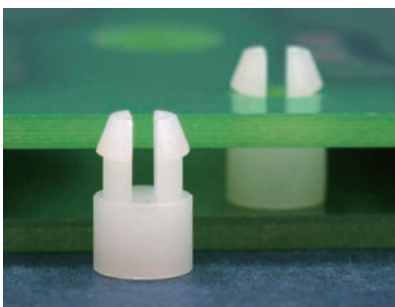

- Material: Nylon 66 (UL)
- Flame Class: 94V-2/94V-0
- Color: Natural/Black
- Unit: mm

MOUNTING HOLE $\varnothing 3.9$
THICKNESS 1.6

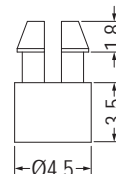

Part No.	Package
MSMA-3.5	2000

PC板間隔柱 SPACER SUPPORT

1



- Material: Nylon 66 (UL)
- Flame Class: 94V-2/94V-0
- Color: Natural/Black
- Unit: mm

MOUNTING HOLE Ø2.5
THICKNESS 1.6

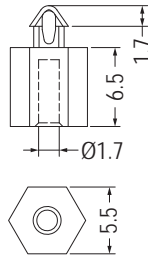

Part No.	Package
MAE2.5-6.5	2000

MOUNTING HOLE Ø2.5
THICKNESS 1.6

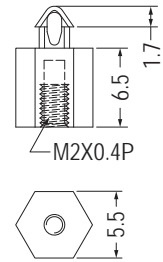

• MAE2.5-6.5T為已攻牙M2X0.4P

Part No.	Package
MAE2.5-6.5T	2000

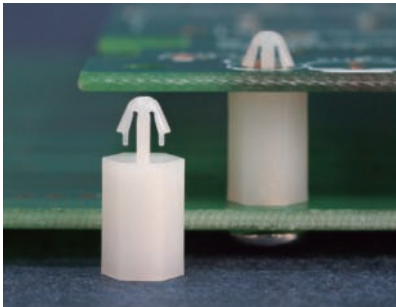

- Material: Nylon 66 (UL)
- Flame Class: 94V-2/94V-0
- Color: Natural/Black
- Unit: mm

用途：PC板端直接壓入固定，另一端可配合M3螺絲或自攻螺絲固定。

MOUNTING HOLE Ø3.0
THICKNESS 1.6

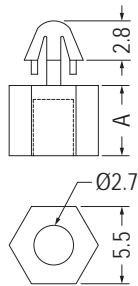

Part No.	A	Package
MAE-4	4.0	1000
MAE-5	5.0	2000
MAE-6	6.0	
MAE-7	7.0	
MAE-8	8.0	
MAE-9	9.0	
MAE-10	10.0	1000
MAE-11	11.0	
MAE-12	12.0	
MAE-13	13.0	

Part No.	A	Package
MAE-14	14.0	1000
MAE-15	15.0	
MAE-16	16.0	
MAE-17	17.0	
MAE-18	18.0	
MAE-19	19.0	
MAE-20	20.0	
MAE-22	22.0	
MAE-23.5	23.5	
MAE-26	26.0	

MOUNTING HOLE Ø3.0
THICKNESS 1.6

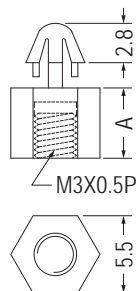

• MAE-XT為已攻牙M3X0.5P

Part No.	A	Package
MAE-5T	5.0	2000
MAE-6T	6.0	
MAE-7T	7.0	
MAE-8T	8.0	
MAE-9T	9.0	
MAE-10T	10.0	1000
MAE-11T	11.0	
MAE-12T	12.0	
MAE-13T	13.0	
MAE-14T	14.0	
MAE-15T	15.0	

Part No.	A	Package
MAE-16T	16.0	1000
MAE-17T	17.0	
MAE-18T	18.0	
MAE-19T	19.0	
MAE-20T	20.0	
MAE-22T	22.0	
MAE-23.5T	23.5	
MAE-26T	26.0	
MAE-26.5T	26.5	
MAE-27T	27.0	

PC板間隔柱 SPACER SUPPORT

用途：PC板端直接壓入固定，另一端可配合M3螺絲或自攻螺絲固定。

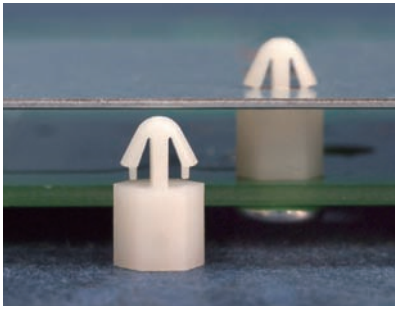

- Material: Nylon 66 (UL)
- Flame Class: 94V-2/94V-0
- Color: Natural/Black
- Unit: mm

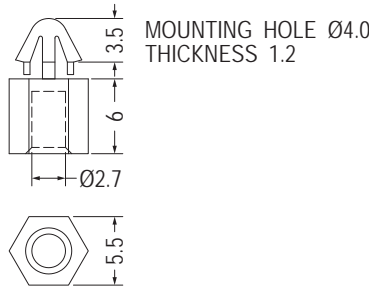

Part No.	Package
MAE4D-6	1000

MOUNTING HOLE Ø4.0
THICKNESS 1.2

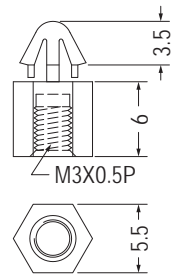

• MAE4D-6T為已攻牙M3X0.5P

Part No.	Package
MAE4D-6T	1000

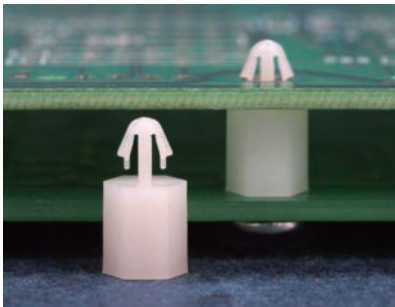

- Material: Nylon 66 (UL)
- Flame Class: 94V-2/94V-0
- Color: Natural/Black
- Unit: mm

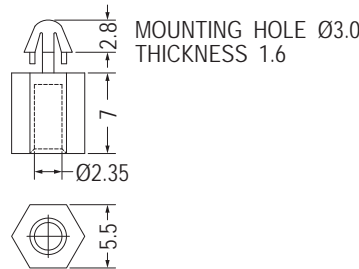

Part No.	Package
MAE7-440	2000

用途：PC板端直接壓入固定，另一端可配合螺絲或自攻螺絲固定。

MOUNTING HOLE Ø3.0
THICKNESS 1.6

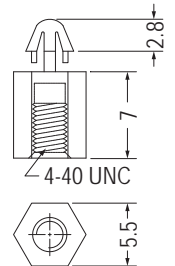

• MAE7-440T為已攻牙4-40UNC

Part No.	Package
MAE7-440T	2000

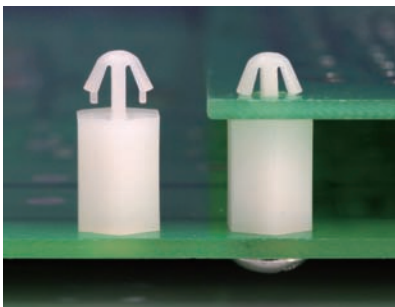

- Material: Nylon 66 (UL)
- Flame Class: 94V-2/94V-0
- Color: Natural/Black
- Unit: mm

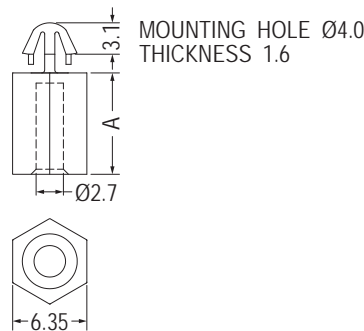

Part No.	A	Package
MAE43-5	5.0	2000
MAE43-6	6.0	
MAE43-7	7.0	
MAE43-8	8.0	
MAE43-9	9.0	
MAE43-10	10.0	
MAE43-11	11.0	
MAE43-12.7	12.7	
MAE43-14	14.0	
MAE43-15	15.0	
MAE43-15.9	15.9	
MAE43-20	20.0	

用途：PC板端直接壓入固定，另一端可配合M3螺絲或自攻螺絲固定。

MOUNTING HOLE Ø4.0
THICKNESS 1.6

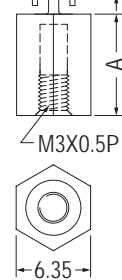

• MAE43-XT為已攻牙M3X0.5P

Part No.	A	Package
MAE43-5T	5.0	2000
MAE43-6T	6.0	
MAE43-7T	7.0	
MAE43-8T	8.0	
MAE43-9T	9.0	
MAE43-10T	10.0	
MAE43-11T	11.0	
MAE43-12.7T	12.7	
MAE43-14T	14.0	
MAE43-15T	15.0	
MAE43-15.9T	15.9	
MAE43-20T	20.0	

MOUNTING HOLE Ø4.0
THICKNESS 1.85

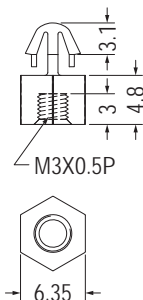

Part No.	Package
MAE43-4.8LT	1000

PC板間隔柱 SPACER SUPPORT

1

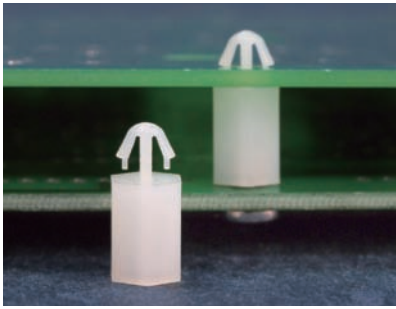

- Material: Nylon 66 (UL)
- Flame Class: 94V-2/94V-0
- Color: Natural/Black
- Unit: mm

MOUNTING HOLE Ø4.0
THICKNESS 1.6

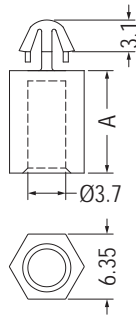

Part No.	A	Package
MAE4-5	5.0	2000
MAE4-6	6.0	
MAE4-7	7.0	
MAE4-8	8.0	
MAE4-9	9.0	
MAE4-10	10.0	
MAE4-11	11.0	
MAE4-12.7	12.7	
MAE4-14	14.0	
MAE4-15	15.0	
MAE4-15.9	15.9	
MAE4-20	20.0	

用途：PC板端直接壓入固定，另一端可配合M4螺絲或自攻螺絲固定。

MOUNTING HOLE Ø4.0
THICKNESS 1.6

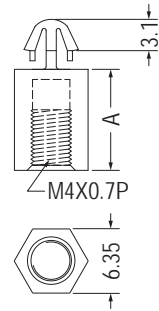

• MAE4-T為已攻牙M4X0.7P

Part No.	A	Package
MAE4-5T	5.0	2000
MAE4-6T	6.0	
MAE4-7T	7.0	
MAE4-8T	8.0	
MAE4-9T	9.0	
MAE4-10T	10.0	
MAE4-11T	11.0	
MAE4-12.7T	12.7	
MAE4-14T	14.0	
MAE4-15T	15.0	
MAE4-15.9T	15.9	
MAE4-20T	20.0	

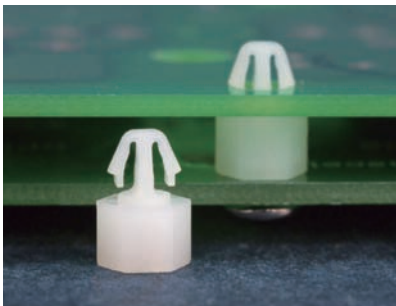

- Material: Nylon 66 (UL)
- Flame Class: 94V-2/94V-0
- Color: Natural/Black
- Unit: mm

MOUNTING HOLE Ø4.0
THICKNESS 1.6

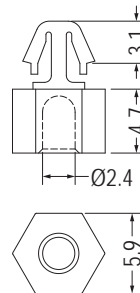

用途：機板部分用鐵板自攻螺絲固定，另一頭直接壓入PC板。

Part No.	Package
MCI-4.7	1000

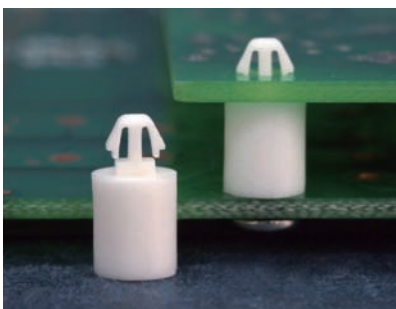

- Material: Nylon 66 (UL)
- Flame Class: 94V-2/94V-0
- Color: Natural/Black
- Unit: mm

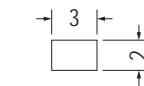
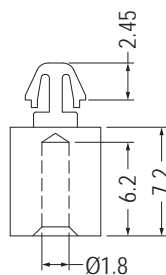

MOUNTING HOLE
THICKNESS 1.6

Part No.	Package
MCSH-7.2	1000

PC板間隔柱 SPACER SUPPORT

用途：支撐PC板，使中間不致震動，載重而凹陷短路。

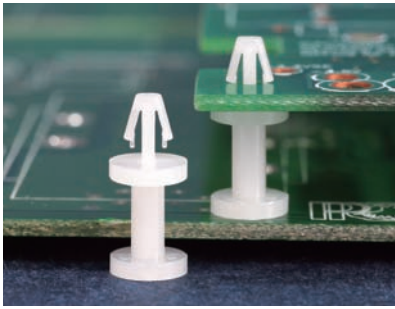

- Material: Nylon 66 (UL)
- Flame Class: 94V-2/94V-0
- Color: Natural/Black
- Unit: mm

MOUNTING HOLE Ø3.0
THICKNESS 1.6

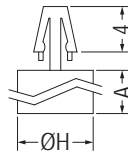

MOUNTING HOLE Ø3.0
THICKNESS: T

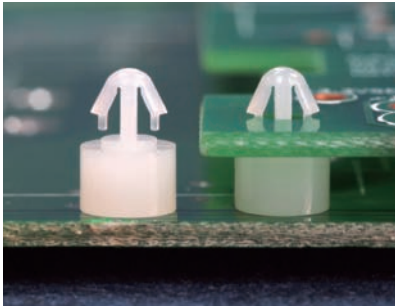
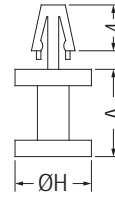

Part No.	A	H	Package
DCB-2	2.0	6.5	2000
DCB-2.5	2.5	6.5	
DCB-3	3.0	6.8	1000
DCB-3.5	3.5	6.8	
DCB-4	4.0	6.8	

Part No.	A	H	T	Package
DCB-5	5.0	6.0	1.6	1000
DCB-5.8	5.8	6.9	1.6	
DCB-6	6.0	6.8	1.6	
DCB-6.5	6.5	6.0	1.6	
DCB-7	7.0	6.0	1.6	
DCB-8	8.0	6.8	1.6	
DCB-8(2)	8.0	6.8	2.1	
DCB-10	10.0	6.8	1.6	
DCB-15	15.0	6.0	1.6	
DCB-15L	15.0	15.0	1.6	
DCB-15S	15.0	6.0	1.6	

MOUNTING HOLE Ø3.0
THICKNESS: T

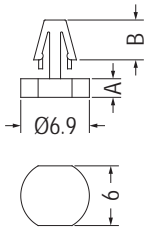

【 DCB-2D,
DCB-3D,
DCB-3.5D 】

MOUNTING HOLE Ø3.0
THICKNESS: T

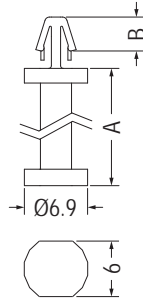

【 DCB-15D 】

MOUNTING HOLE Ø3.0
THICKNESS: T

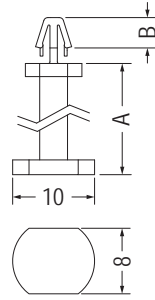

【 DCB-16DL,
DCB-20DL 】

MOUNTING HOLE Ø3.0
THICKNESS: T

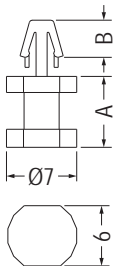

Part No.	A	B	T	Package
DCB-2D	2.0	3.5	1.2~1.7	2000
DCB-3D	3.0	3.7	1.2~1.6	
DCB-3.5D	3.5	4.0	1.2~1.6	1000
DCB-4D	4.0	3.6	1.2~1.7	
DCB-4.5D	4.5	3.6	1.2~1.7	
DCB-5D	5.0	3.6	1.2~1.7	
DCB-5.5D	5.5	4.0	1.2~1.6	
DCB-7D	7.0	4.0	1.2~1.6	

Part No.	A	B	T	Package
DCB-8D	8.0	3.85	1.2~1.7	1000
DCB-8.5D	8.5	4.0	1.2~1.7	
DCB-9D	9.0	4.0	1.2~1.6	
DCB-11D	11.0	3.7	1.2~1.6	
DCB-12D	12.0	4.0	1.2~1.6	
DCB-13D	13.0	4.0	1.2~1.6	
DCB-15D	15.0	3.7	1.2~1.6	
DCB-16DL	16.0	3.7	1.2~1.6	
DCB-20DL	20.0	3.7	1.2~1.6	

MOUNTING HOLE Ø3.0
THICKNESS 3.0

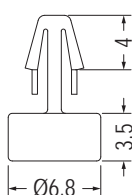

Part No.	Package
DCBA-3.5	1000

MOUNTING HOLE Ø3.1
THICKNESS 1.6

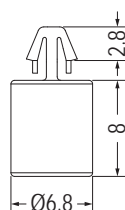

Part No.	Package
DCBA-8	1000

MOUNTING HOLE Ø3.5
THICKNESS 1.6

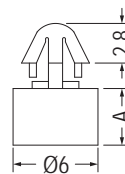

Part No.	A	Package
PDC-3	3.0	2000
PDC-3.5	3.5	
PDC-4	4.0	

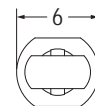

MOUNTING HOLE Ø3.5
THICKNESS 1.6

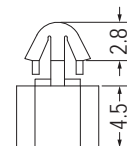

Part No.	Package
PDC-4.5D	2000

PC板間隔柱 SPACER SUPPORT

用途：支撐PC板，使中間不致震動，載重而凹陷短路。

- Material: Nylon 66 (UL)
- Flame Class: 94V-2/94V-0
- Color: Natural/Black
- Unit: mm

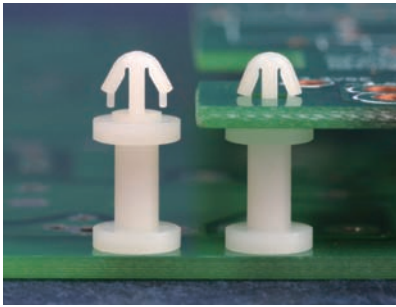

MOUNTING HOLE Ø3.5
THICKNESS: T

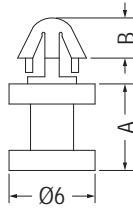

Part No.	A	B	T	Package
PDC-5	5.0	2.8	1.6	2000
PDC-9	9.0	2.8	1.6	
PDC-10	10.0	2.6	1.8	

MOUNTING HOLE Ø3.5
THICKNESS: T

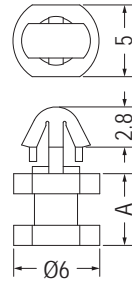

Part No.	A	T	Package
PDC-5.5D	5.5	1.6	2000
PDC-6D	6.0	1.6	
PDC-6.5D	6.5	1.6	
PDC-7D	7.0	1.6	
PDC-13D	13.0	1.2~1.7	
PDC-13.5D	13.5	1.6	
PDC-26D	26.0	1.6	



MOUNTING HOLE Ø3.5
THICKNESS 1.6

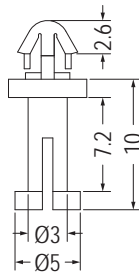

Part No.	Package
MCN-10	1000

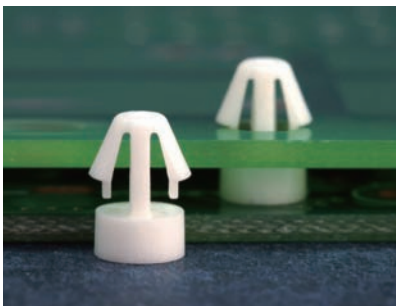

MOUNTING HOLE Ø4.0
THICKNESS: T

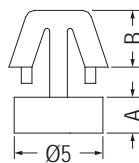

Part No.	A	B	T	Package
MC-2	2.0	3.1	1.2~1.7	2000
MC-2-1.2	2.0	3.5	0.8~1.0	
MC-2.5	2.5	3.65	1.2~1.7	1000

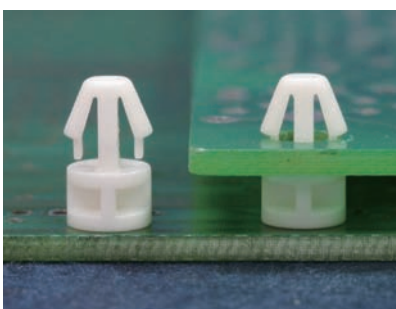

MOUNTING HOLE Ø4.0
THICKNESS 1.2~1.6

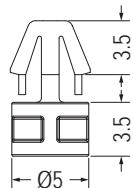

Part No.	Package
MC-3.5-1	1000

MOUNTING HOLE Ø4.0
THICKNESS 1.6

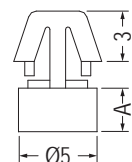

Part No.	A	Package
MC-3	3.0	2000
MC-3.2	3.2	
MC-3.5	3.5	
MC-4	4.0	
MC-5	5.0	

PC板間隔柱 SPACER SUPPORT

用途：支撐PC板，使中間不致震動，載重而凹陷短路。

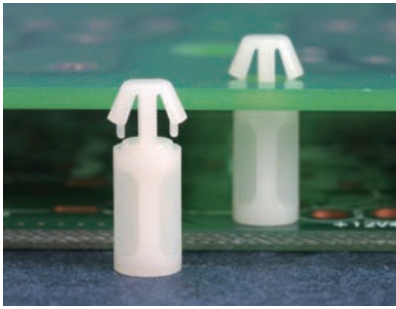

- Material: Nylon 66 (UL)
- Flame Class: 94V-2/94V-0
- Color: Natural/Black
- Unit: mm

P.C.B Ø4.0
THICKNESS 1.6

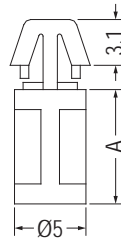

Part No.	A	Package
MC-6	6.3	2000
MC-7	7.0	
MC-7.5	7.5	
MC-8	8.0	
MC-8.5	8.5	
MC-9	9.0	
MC-10	10.0	1000
MC-11.5	11.5	
MC-12	12.7	
MC-16.4	16.4	

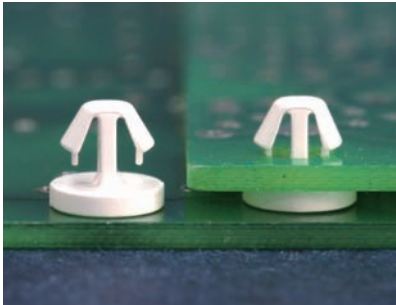

P.C.B Ø4.0
THICKNESS 1.6~1.9

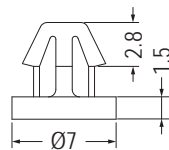

Part No.	Package
MCEA-1.9	1000

P.C.B Ø4.0
THICKNESS 1.6~1.8

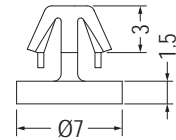

- Material: PC (UL)

Part No.	Package
MCE-1.9	1000

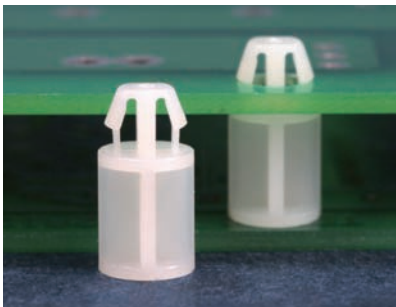

P.C.B Ø4.8
THICKNESS 1.6

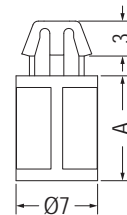

Part No.	A	Package
MCL-9	9.0	2000
MCL-16	16.0	

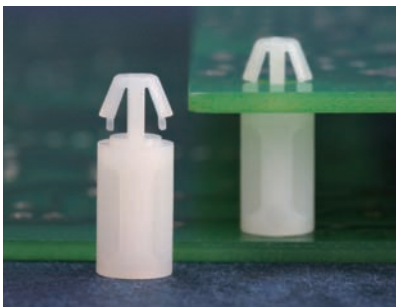

- Material: Nylon 66 (UL)
- Flame Class: 94V-2/94V-0
- Color: Natural/Black
- Unit: mm

P.C.B Ø4.0
THICKNESS 1.6

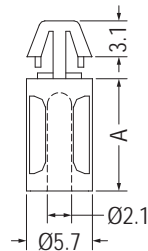

用途：支撐PC板，使中間不致震動，載重而凹陷短路，鐵板可鑽孔用螺絲固定。

Part No.	A	Package
MCH-6	6.35	1000
MCH-10	9.7	
MCH-12	12.7	

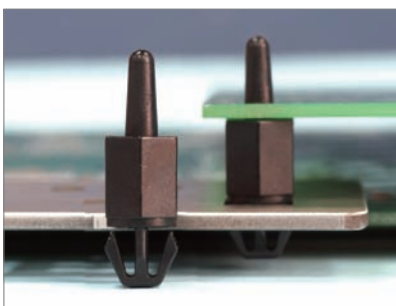

- Material: Nylon 66 (UL)
- Flame Class: 94V-2/94V-0
- Color: Natural/Black
- Unit: mm



用途：PC板直接壓入固定，另一端直接壓入機板固定，省時易拆裝。

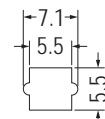
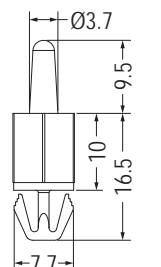

MOUNTING HOLE
THICKNESS 0.8~1.6

Part No.	Package
KVLMMA-10	1000

PC板間隔柱 SPACER SUPPORT

1

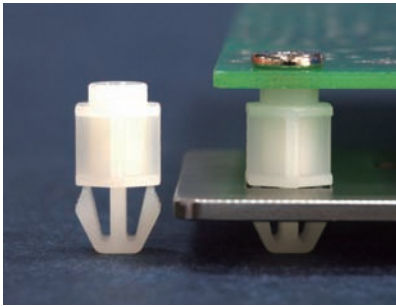

- Material: Nylon 66 (UL)
- Flame Class: 94V-2/94V-0
- Color: Natural/Black
- Unit: mm

用途：固定PC板於機板上，一頭配合螺絲使用，不旋轉。

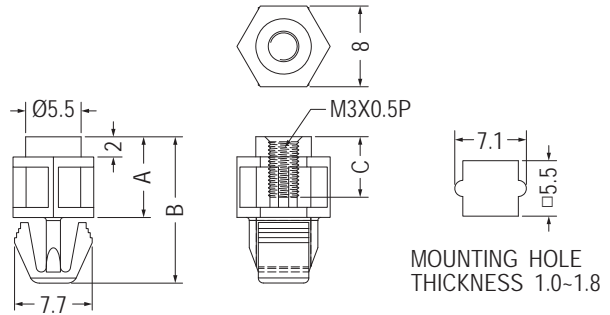

Part No.	A	B	C	Package
KVLM3-5	5.0	11.5	3.0	1000
KVLM3-6	6.0	12.5	4.0	
KVLM3-6.35	6.35	12.85	4.35	
KVLM3-8	8.0	14.5	6.0	
KVLM3-9.5	9.5	16.0	8.0	
KVLM3-10	10.0	16.5	8.0	
KVLM3-12	12.0	18.5	8.0	

Part No.	A	B	C	Package
KVLM3-12.7	12.7	19.2	8.0	1000
KVLM3-15.9	15.9	22.4	8.0	
KVLM3-18	18.0	24.5	8.0	
KVLM3-20	20.0	26.5	8.0	
KVLM3-22	22.0	28.5	8.0	
KVLM3-25.4	25.4	31.9	8.0	

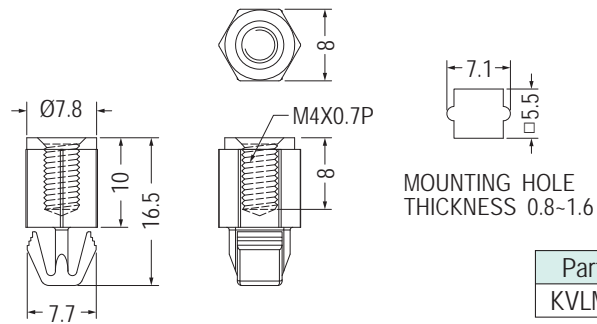
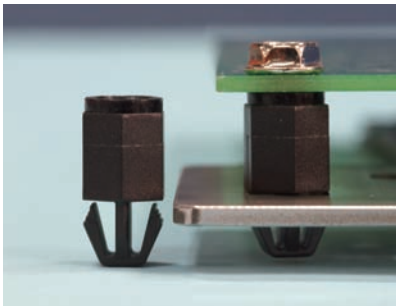

Part No.	Package
KVLM4-10	1000

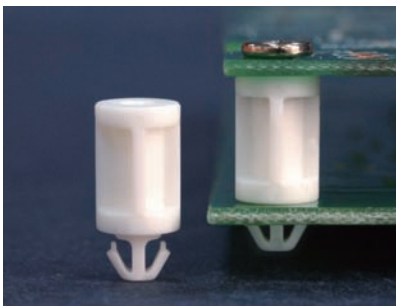

- Material: Nylon 66 (UL)
- Flame Class: 94V-2/94V-0
- Color: Natural/Black
- Unit: mm

用途：固定PC板於機板上，一頭配合螺絲使用。

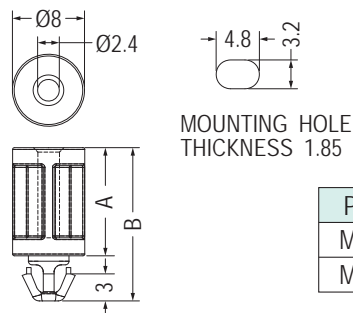

Part No.	A	B	Package
MCIA-12	12.0	17.0	1000
MCIA-16	16.0	21.0	

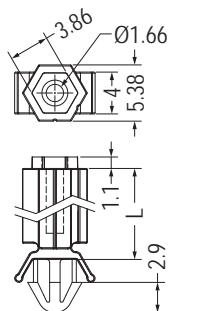
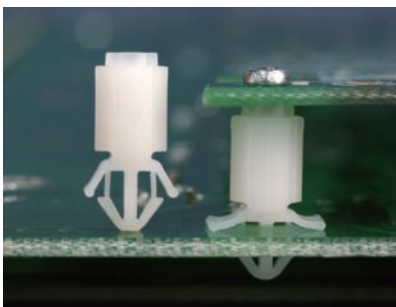

Part No.	L	Package
TCBC-8.7	8.7	1000
TCBC-13.7	13.7	

MOUNTING HOLE Ø4.0
THICKNESS 0.8-1.6

PC板間隔柱 SPACER SUPPORT

用途：固定PC板於機板上，一頭配合自攻螺絲使用。

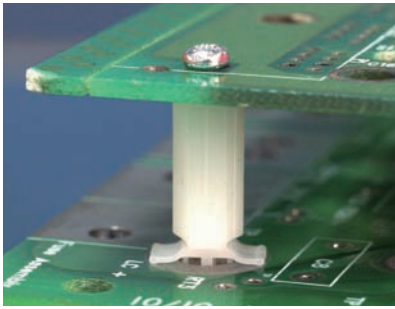

- Material: Nylon 66 (UL)
- Flame Class: 94V-2/94V-0
- Color: Natural/Black
- Unit: mm

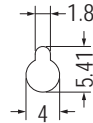
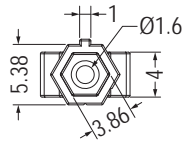

MOUNTING HOLE THICKNESS 0.8

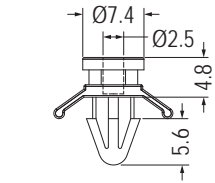

MOUNTING HOLE Ø4.8-Ø5.0 THICKNESS 2.0

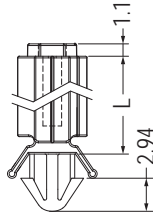

Part No.	L	Package
TCBE-8.7	8.7	1000
TCBE-13.7	13.7	

Part No.	Package
TCBD-4.8	1000

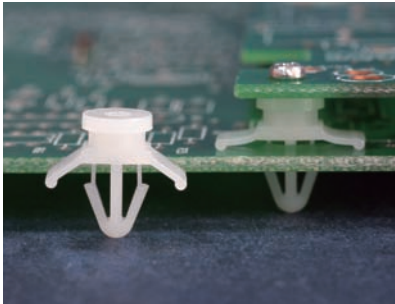

- Material: Nylon 66 (UL)
- Flame Class: 94V-2/94V-0
- Foot Material: Silicon Rubber (UL)
- Foot Flame Class: 94V-0
- Color: Natural/Black
- Unit: mm

用途：固定PC板於機板上，一頭有矽膠墊片支撐PC板，避免震動。

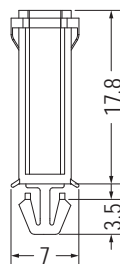

MOUNTING HOLE Ø4.0 THICKNESS 1.6

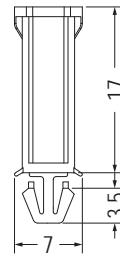

(SPACER SUPPORT)
【TCBH-17】

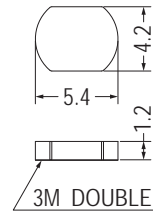

(FOOT)

3M DOUBLE ADHESIVE TAPE

【TF-1752I】



Part No.	Part No.	Package
TCBH-17F	TCBH-17	1000
	TF-1752I	
上述零件可單獨選購		

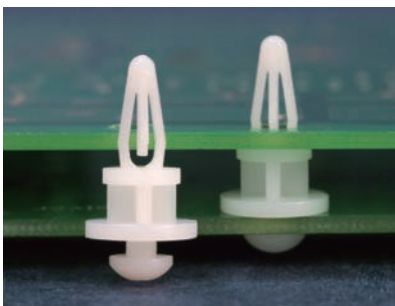

- Material: Nylon 66 (UL)
- Flame Class: 94V-2/94V-0
- Color: Natural/Black
- Unit: mm

用途：一般用於電腦機板固定。

P.C.B Ø4.0 THICKNESS 1.6

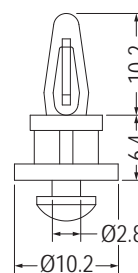

THICKNESS 1.6

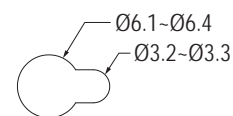

MOUNTING HOLE

Part No.	Package
ACBR-6	1000

PC板間隔柱 SPACER SUPPORT

用途：一般用於電腦機板固定。

1

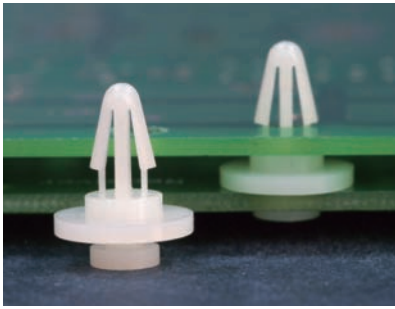

- Material: Nylon 66 (UL)
- Flame Class: 94V-2/94V-0
- Color: Natural/Black
- Unit: mm

P.C.B Ø4.0
THICKNESS 2.7

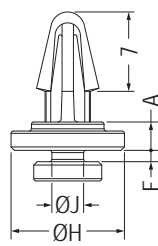

【ACB-2.3】

P.C.B Ø4.0
THICKNESS 1.6-2.0

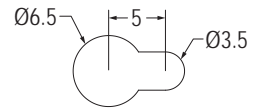
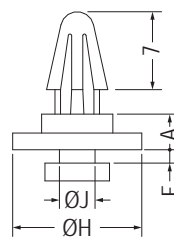

MOUNTING HOLE

Part No.	A	F	H	J	Package
ACB-2.3	2.5	1.0	10.0	2.8	1000
ACB-2.5	2.5	1.4	11.5	2.8	
ACB-3	3.2	1.2	11.6	3.2	

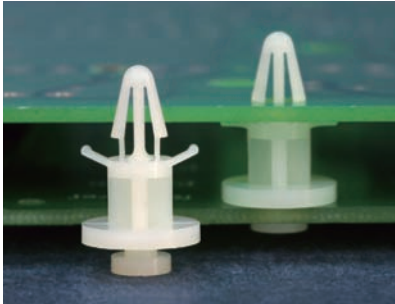

P.C.B Ø4.0
THICKNESS: T

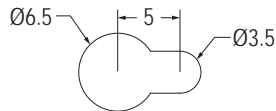
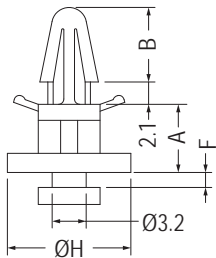

MOUNTING HOLE

Part No.	A	B	F	H	T	Package
ACB-5	5.0	7.0	1.3	11.7	1.6	1000
ACB-6	6.3	7.0	1.3	11.6	1.6	
ACB-8	8.0	7.0	1.4	11.6	1.6	
ACB-60	60.0	7.3	2.8	11.3	1.2~1.7	250
ACB-68	68.0	7.3	1.3	11.3	1.6	
ACB-74	74.0	7.3	1.3	11.3	1.6	

P.C.B Ø4.0
THICKNESS 1.6

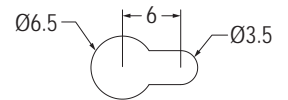
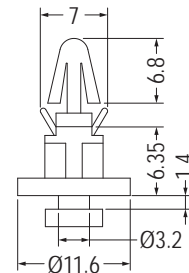

MOUNTING HOLE

Part No.	Package
MCB-6	500

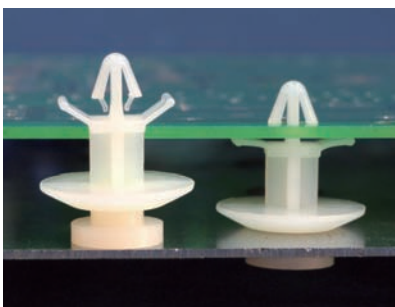

P.C.B Ø4.5
THICKNESS 1.2-2.0

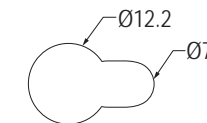
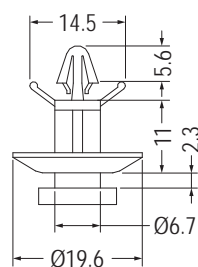

MOUNTING HOLE

Part No.	Package
MBC-11	500

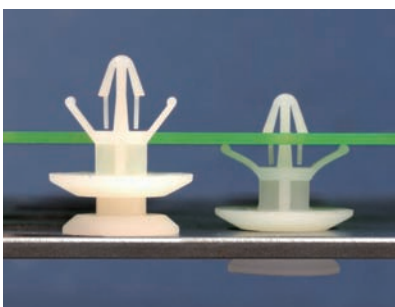

P.C.B Ø4.5-Ø4.8
THICKNESS 0.8-2.5

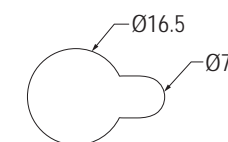
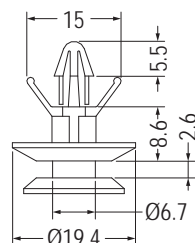

MOUNTING HOLE

Part No.	Package
MBD-10	500

PC板間隔柱 SPACER SUPPORT

用途：機板部份用鐵板自攻螺絲固定，另一頭直接壓入PC板。

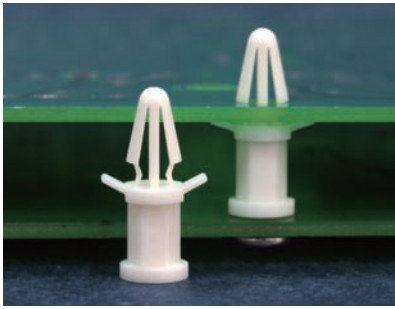

- Material: Nylon 66 (UL)
- Flame Class: 94V-2/94V-0
- Color: Natural/Black
- Unit: mm

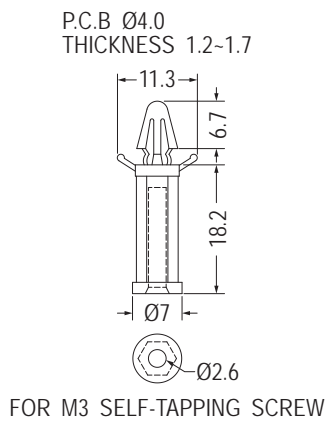

Part No.	Package
TCBS-18	1000

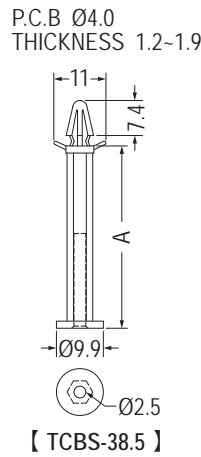

FOR M3 SELF-TAPPING SCREW

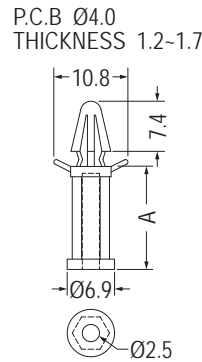

Part No.	A	Package
TCBS-5	5.0	1000
TCBS-6A	6.0	
TCBS-6	6.35	
TCBS-7	7.0	
TCBS-9.5	9.5	
TCBS-10	10.0	
TCBS-12.5	12.5	
TCBS-15	15.0	
TCBS-20	20.0	
TCBS-24.5	24.5	
TCBS-25	25.0	
TCBS-26	26.0	
TCBS-30	30.0	
TCBS-35	35.0	
TCBS-38.5	38.5	

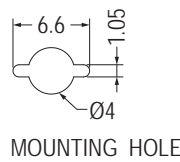
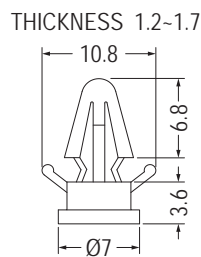
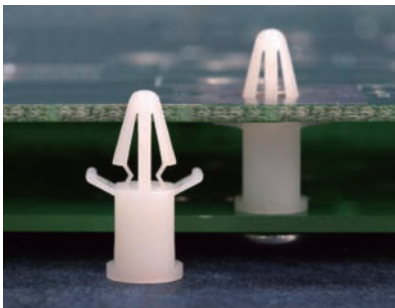

THICKNESS 1.2-1.7

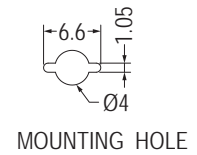
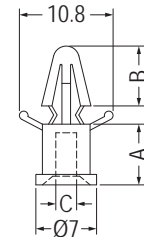

FOR SCREW

Part No.	Package
TCBT-3.6	1000

Part No.	A	B	C	Screw	Package
TCBT-7	7.0	6.9	2.4	4-40 UNC	1000
TCBT-7.7	7.7	5.9	2.6	M3	
TCBT-8.5	8.5	6.9	2.6	M3	
TCBT-16	16.0	6.9	2.4	4-40 UNC	

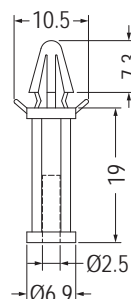
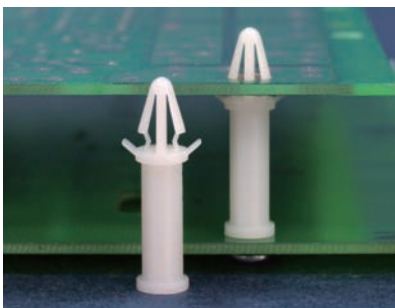

P.C.B THICKNESS 1.2-1.9

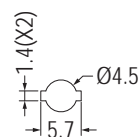

MOUNTING HOLE

FOR M3 SCREW

Part No.	Package
TCBT-19	1000

PC板間隔柱 SPACER SUPPORT

用途：支撐PC板，使中間不致震動，載重而凹陷短路。

1

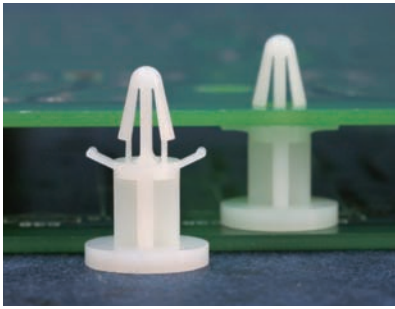

- Material: Nylon 66 (UL)
- Flame Class: 94V-2/94V-0
- Color: Natural/Black
- Unit: mm

MOUNTING HOLE Ø4.0
THICKNESS 1.2-1.7

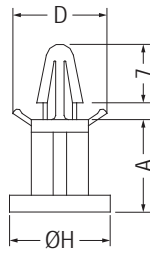

Part No.	A	D	H	Package
MBS-6	6.4	11.4	11.8	1000
MBS-8	8.0	11.4	11.8	
MBS-8.9S	8.9	11.1	8.0	
MBS-8.9	8.9	11.1	11.9	
MBS-9.5L	9.5	11.4	20.0	
MBS-10	10.0	11.4	12.0	500
MBS-11	11.0	11.4	12.0	
MBS-14	14.0	11.4	12.0	250
MBS-74	74.0	10.4	11.3	

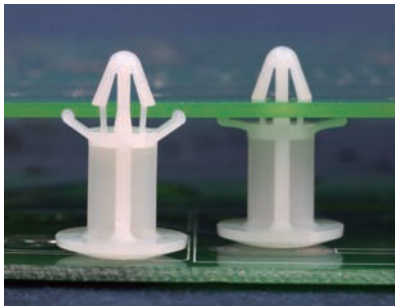

MOUNTING HOLE Ø4.5
THICKNESS 1.2-1.7

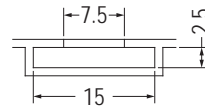
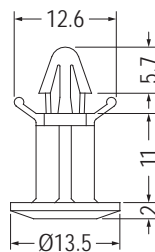

MOUNTING HOLE

Part No.	Package
MTD-11	500

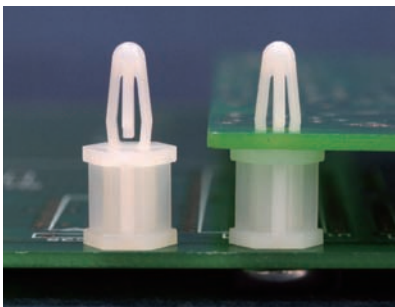

- Material: Nylon 66 (UL)
- Flame Class: 94V-2/94V-0
- Color: Natural/Black
- Unit: mm

用途：機板部份用M3.5鐵板自攻螺絲固定，另一頭直接壓入PC板。

MOUNTING HOLE Ø4.0
THICKNESS 1.6

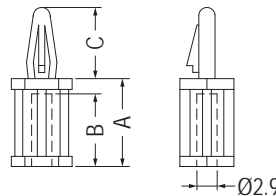

FOR M3.5
SELF-TAPPING SCREW

Part No.	A	B	C	Package
BS-6	6.4	4.8	10.2	1000
BS-9	9.5	8.0	10.2	
BS-12	12.7	11.0	10.2	
BS-14	14.0	12.7	10.2	
BS-15S	15.0	13.0	10.4	
BS-15	15.9	13.0	10.2	
BS-19	19.1	16.2	10.2	
BS-22	22.2	19.4	10.2	
BS-25	25.4	24.0	10.2	
BS-28	28.6	25.9	10.2	
BS-29	29.0	25.9	10.2	

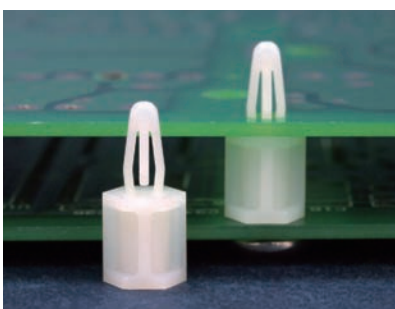

MOUNTING HOLE Ø4.0
THICKNESS 2.0

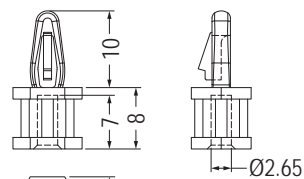

FOR M3X6
SELF-TAPPING SCREW

Part No.	Package
BS-8	1000

MOUNTING HOLE Ø4.0
THICKNESS 1.6

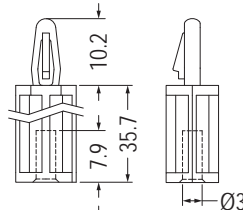

FOR M3.5
SELF-TAPPING SCREW

Part No.	Package
★BS-35.7	500

MOUNTING HOLE Ø4.0
THICKNESS 2.0

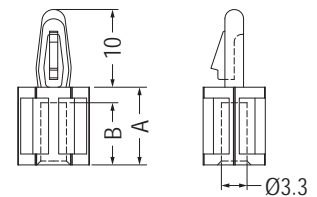

FOR M3.5-M4
SELF-TAPPING SCREW

Part No.	A	B	Package
BS-10-1	10.0	8.0	1000
BS-20-1	20.0	12.0	

PC板間隔柱 SPACER SUPPORT

用途：機板部份用M3鐵板自攻螺絲固定，另一頭直接壓入PC板。

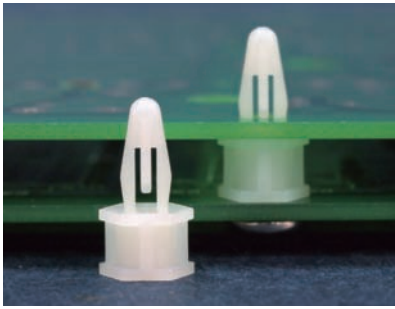

- Material: Nylon 66 (UL)
- Flame Class: 94V-2/94V-0
- Color: Natural/Black
- Unit: mm

MOUNTING HOLE Ø4.0
THICKNESS 1.2-1.7

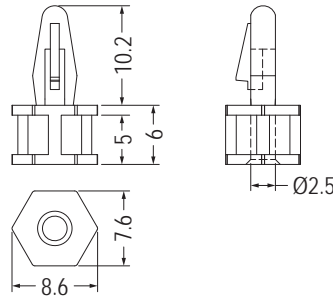

Part No.	Package
BSB-6	1000

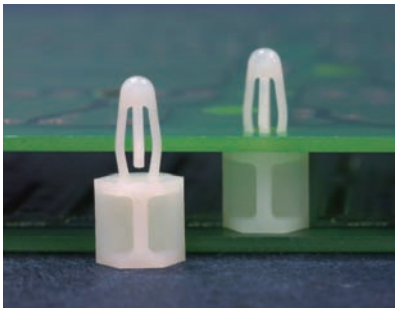

- Material: Nylon 66 (UL)
- Flame Class: 94V-2/94V-0
- Color: Natural/Black
- Unit: mm

用途：支撐PC板，使中間不致震動，載重而凹陷短路。

MOUNTING HOLE Ø4.2
THICKNESS 1.6

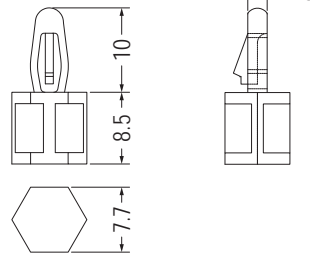

Part No.	Package
BSB-8.5	1000

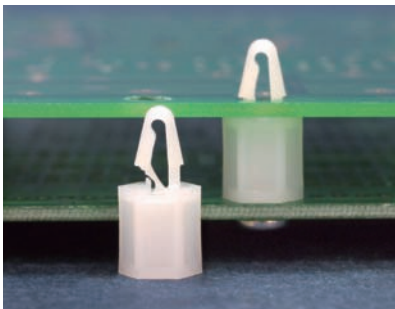

- Material: Nylon 66 (UL)
- Flame Class: 94V-2/94V-0
- Color: Natural/Black
- Unit: mm

用途：機板部份用M3.5鐵板自攻螺絲固定，另一頭直接壓入PC板。

MOUNTING HOLE Ø4.0
THICKNESS 1.6-2.0

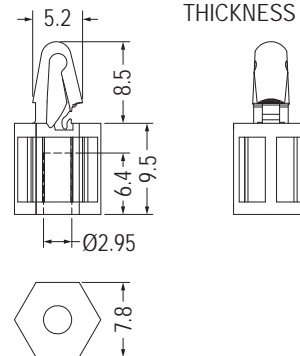

Part No.	Package
BSCL-9.5	1000

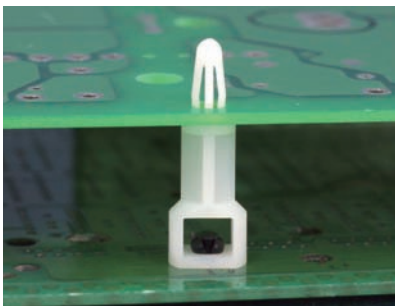

- Material: Nylon 66 (UL)
- Flame Class: 94V-2/94V-0
- Color: Natural/Black
- Unit: mm

用途：一端配合SR4系列鉚釘固定於機板上，一端固定於PC板上。

MOUNTING HOLE Ø4.0
THICKNESS 1.6

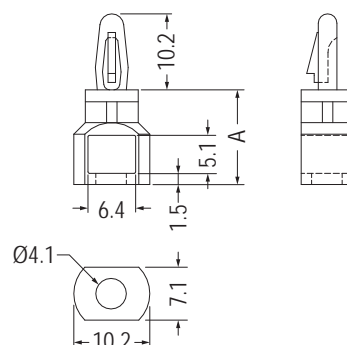

Part No.	A	Package
SRLCB-9	9.5	1000
SRLCB-11	11.1	
SRLCB-12	12.7	
SRLCB-15	15.9	
SRLCB-19.1	19.1	
SRLCB-22	22.2	
SRLCB-25	25.4	

PC板間隔柱 SPACER SUPPORT

用途：一端配合SR4系列鉚釘固定於機板上，一端固定於PC板上。



- Material: Nylon 66 (UL)
- Flame Class: 94V-2/94V-0
- Color: Natural/Black
- Unit: mm

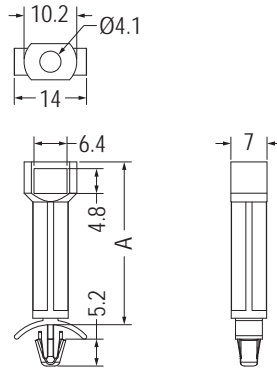

P.C.B Ø4.75-Ø4.8
THICKNESS 0.8-2.0

Part No.	A	Package
SRLA-29.5	29.5	1000
SRLA-31.5	31.5	

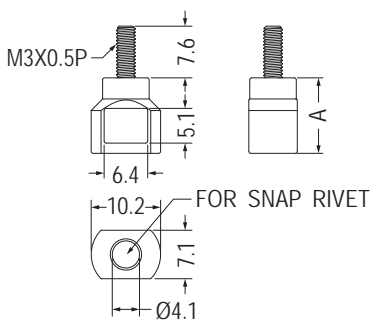

Part No.	A	Package
TCEB3-9.5	9.5	1000
TCEB3-11.1	11.1	

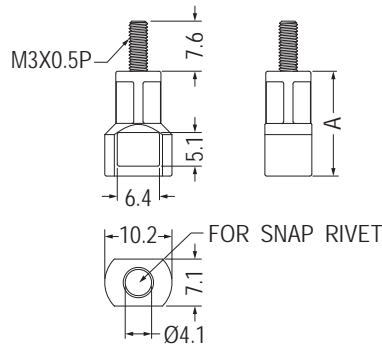

Part No.	A	Package
TCEB3-12.7	12.7	1000
TCEB3-15.9	15.9	
TCEB4-19.1	19.1	
TCEB4-22.2	22.2	
TCEB3-25.4	25.4	

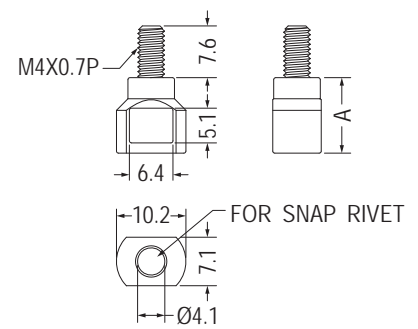

Part No.	A	Package
TCEB4-9.5	9.5	1000
TCEB4-11.1	11.1	

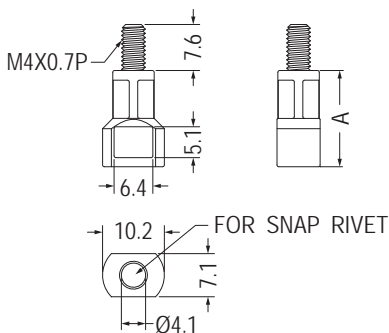

Part No.	A	Package
TCEB4-12.7	12.7	1000
TCEB4-15.9	15.9	
TCEB4-19.1	19.1	
TCEB4-22.2	22.2	
TCEB4-25.4	25.4	

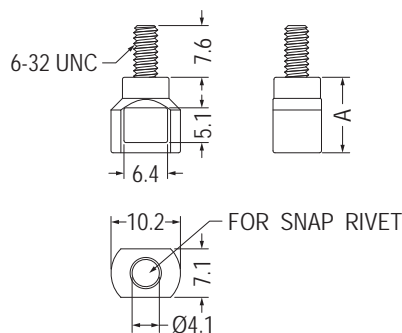

Part No.	A	Package
TCEB632-9.5	9.5	1000
TCEB632-11.1	11.1	

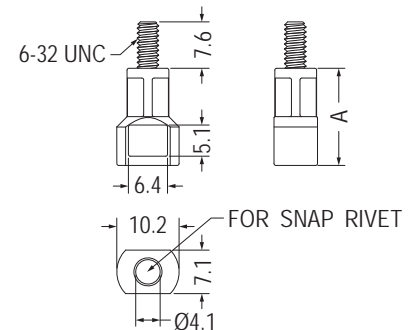

Part No.	A	Package
TCEB632-12.7	12.7	1000
TCEB632-15.9	15.9	
TCEB632-19.1	19.1	
TCEB632-22.2	22.2	
TCEB632-25.4	25.4	

PC板間隔柱 SPACER SUPPORT

用途：機板部份用螺絲固定，另一頭直接壓入PC板。

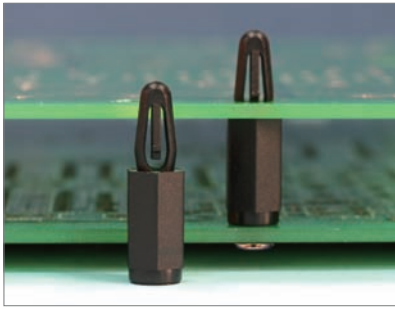

- Material: Nylon 66 (UL)
- Flame Class: 94V-2/94V-0
- Color: Natural/Black
- Unit: mm

MOUNTING HOLE Ø4.0
THICKNESS 1.6

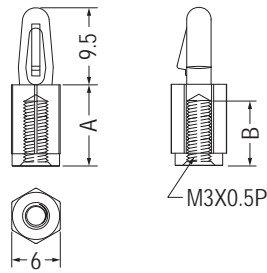

Part No.	A	B	Package
BSCB-10	10.0	8.0	1000
BSCB-12	12.0	8.0	
BSCB-15	15.0	10.0	
BSCB-25	25.0	10.0	

MOUNTING HOLE Ø4.0
THICKNESS 1.8

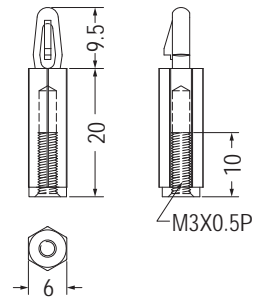

Part No.	Package
BSCB-20	1000

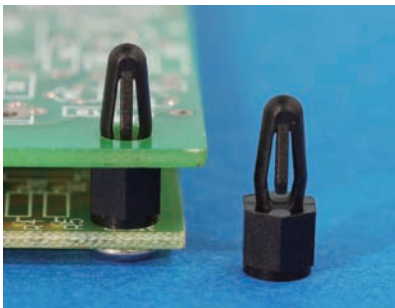

MOUNTING HOLE Ø4.0
THICKNESS 2.0

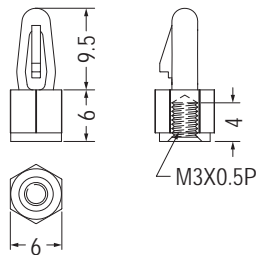

Part No.	Package
BSCB-6	1000

MOUNTING HOLE Ø4.0
THICKNESS 1.6

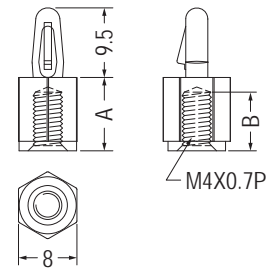

Part No.	A	B	Package
BSCB4-6	6.0	4.0	1000
BSCB4-8	8.0	6.0	
BSCB4-10	10.0	8.0	



- Material: Nylon 66 (UL)
- Flame Class: 94V-2/94V-0
- Color: Natural/Black
- Unit: mm

用途：機板部份用6-32鐵板自攻螺絲固定，另一頭直接壓入PC板。

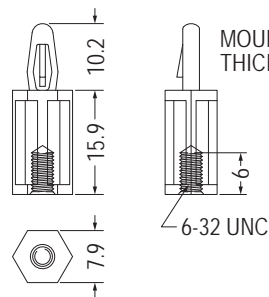

Part No.	Package
BSB632-15.9	1000

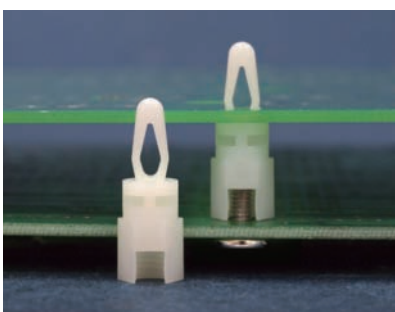

- Material: Nylon 66 (UL)
- Flame Class: 94V-2/94V-0
- Color: Natural/Black
- Unit: mm

用途：機板部份用螺絲固定，另一頭直接壓入PC板。

MOUNTING HOLE Ø4.0
THICKNESS 1.57

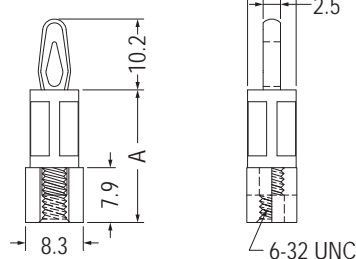

Part No.	A	Package
BSC632-9.5	9.5	1000
BSC632-12.7	12.7	
BSC632-15.9	15.9	
BSC632-19.1	19.1	
BSC632-22.2	22.2	
BSC632-25.4	25.4	

PC板間隔柱 SPACER SUPPORT

用途：機板部份用螺絲固定，另一頭直接壓入PC板。

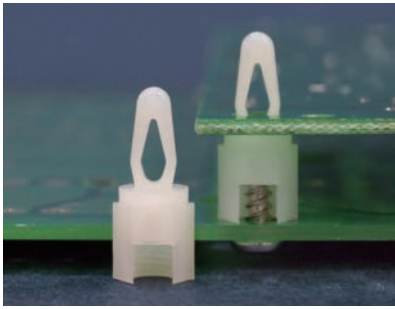

- Material: Nylon 66 (UL)
- Flame Class: 94V-2/94V-0
- Color: Natural/Black
- Unit: mm

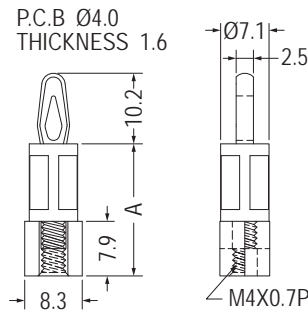

Part No.	A	Package
BSCM4-9.5	9.5	1000
BSCM4-12.7	12.7	
BSCM4-15.9	15.9	
BSCM4-19.1	19.1	
BSCM4-22.2	22.2	
BSCM4-25.4	25.4	

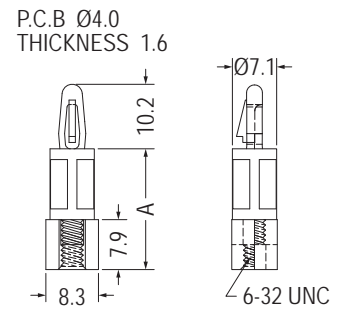
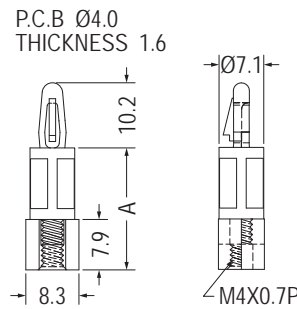
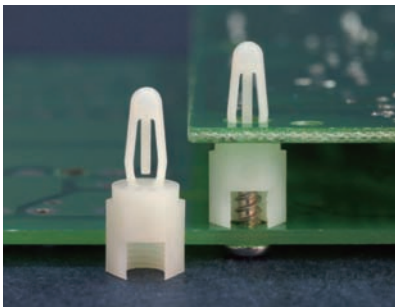

Part No.	A	Package
BSDM4-9.5	9.5	1000
BSDM4-12.7	12.7	
BSDM4-15.9	15.9	
BSDM4-19.1	19.1	
BSDM4-22.2	22.2	
BSDM4-25.4	25.4	

Part No.	A	Package
BSD632-9.5	9.5	1000
BSD632-12.7	12.7	
BSD632-15.9	15.9	
BSD632-19.1	19.1	
BSD632-22.2	22.2	
BSD632-25.4	25.4	

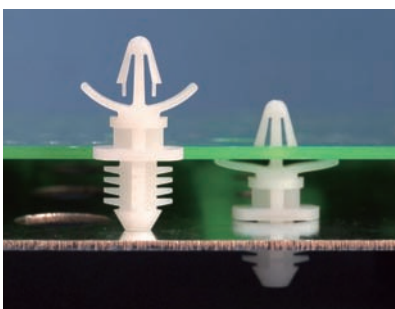

- Material: Nylon 66 (UL)
- Flame Class: 94V-2/94V-0
- Color: Natural/Black
- Unit: mm

用途：一端固定於木頭或音箱上，另一端固定於PC板上。

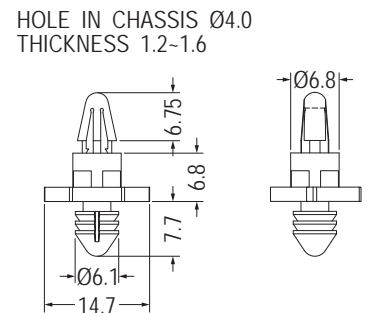
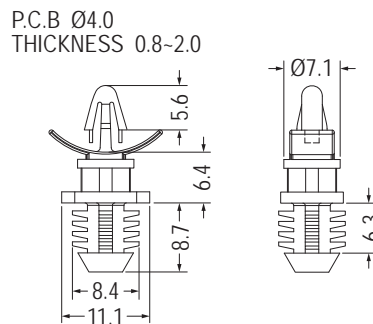

HOLE IN PANEL Ø7.9 THICKNESS 6.4

HOLE IN WOODENWARE Ø6.0 THICKNESS 7.0

Part No.	Package
WBHC-6.4	1000

Part No.	Package
ACBW-6.8	1000

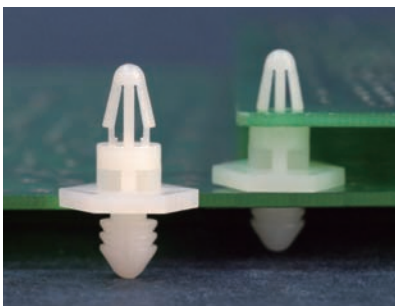

PC板間隔柱 SPACER SUPPORT

用途：一端固定於木頭或音箱上，另一端固定於PC板上。

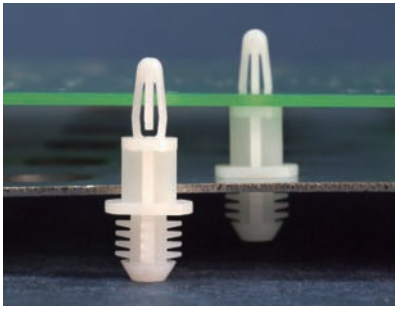

- Material: Nylon 66 (UL)
- Flame Class: 94V-2/94V-0
- Color: Natural/Black
- Unit: mm

P.C.B Ø4.0
THICKNESS 1.2-1.7

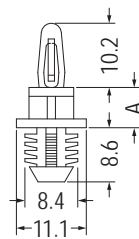

HOLE IN PANEL Ø7.9
THICKNESS 6.4

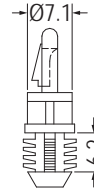

Part No.	A	Package
WBH-5	4.8	1000
WBH-6	6.4	
WBH-9	9.5	
WBH-11	11.1	
WBH-12	12.7	
WBH-16	15.9	
WBH-19	19.1	
WBH-22	22.2	
WBH-25	25.4	

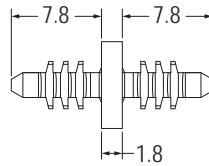
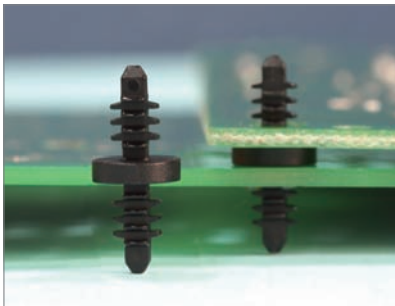

MOUNTING HOLE Ø4.0
THICKNESS 2.6-6.3

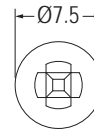

Part No.	Package
WBHB-1.8	1000



- Material: Nylon 66 (UL)
- Flame Class: 94V-2/94V-0
- Color: Natural/Black
- Unit: mm

用途：一端固定於機板上，另一端支撐PC板，避免下陷造成短路，PC板免鑽孔。

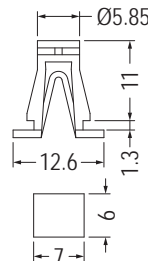

MOUNTING HOLE

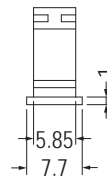

Part No.	Package
PAA-11	1000

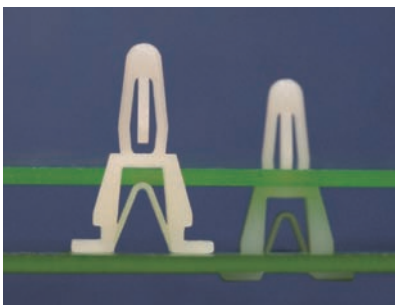

- Material: Nylon 66 (UL)
- Flame Class: 94V-2/94V-0
- Color: Natural/Black
- Unit: mm

用途：固定PC板於機板上，不會突出機板底部，外觀美麗。

P.C.B Ø4.0
THICKNESS 0.8-1.7

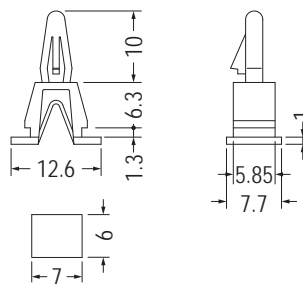

MOUNTING HOLE

P.C.B Ø4.0
THICKNESS 1.2-1.7

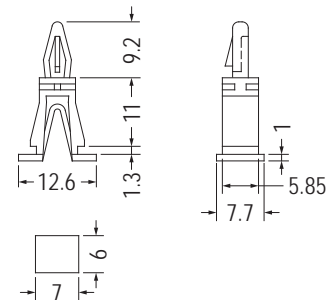

MOUNTING HOLE

Part No.	Package
PCC-6	2000

Part No.	Package
PCC-11	1000

PC板間隔柱 SPACER SUPPORT

用途：支撐PC板，使中間不致震動，載重而凹陷短路，吸震力強。

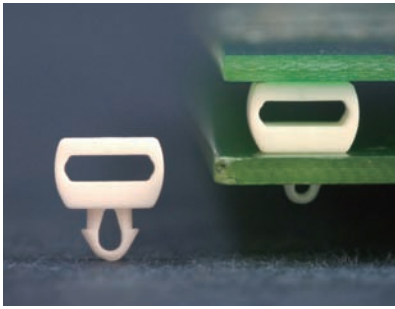

- Material: Nylon 66 (UL)
- Flame Class: 94V-2/94V-0
- Color: Natural/Black
- Unit: mm

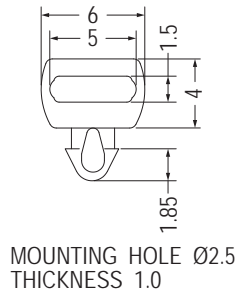

MOUNTING HOLE Ø2.5
THICKNESS 1.0

Part No.	Package
LIJ-4	2000

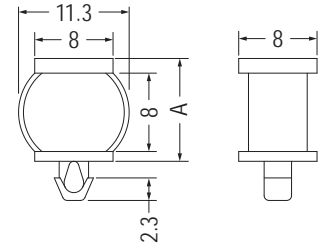

MOUNTING HOLE Ø3.0
THICKNESS 1.6

Part No.	A	Package
LIO-10	10.0	2000
LIO-10.5	10.5	

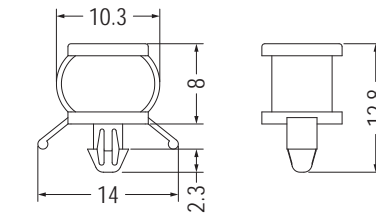
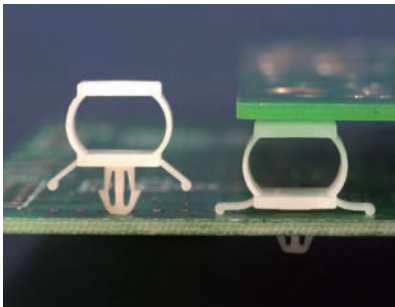

MOUNTING HOLE Ø3.0
THICKNESS 1.1-1.6

Part No.	Package
LIO-8	2000



- Material: Nylon 66 (UL)
- Flame Class: 94V-2/94V-0
- Color: Natural/Black
- Unit: mm

用途：配合螺絲固定電漿面板於機殼上，可靠不脫落。

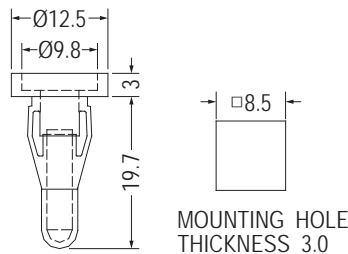

MOUNTING HOLE
THICKNESS 3.0

Part No.	Package
YES-3	500

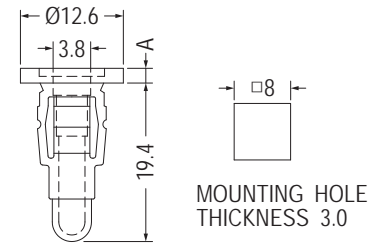

MOUNTING HOLE
THICKNESS 3.0

Part No.	A	Package
YES-08	0.8	500
YES-32	3.2	
YES-48	4.8	

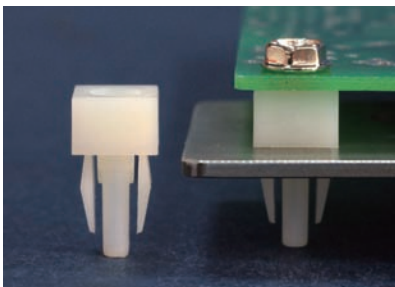

- Material: Nylon 66 (UL)
- Flame Class: 94V-2/94V-0
- Color: Natural/Black
- Unit: mm

用途：可搭配自攻牙螺絲用於PC板之固定。

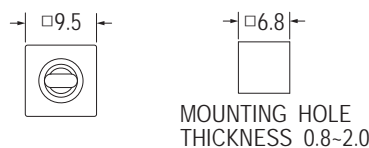

MOUNTING HOLE
THICKNESS 0.8-2.0

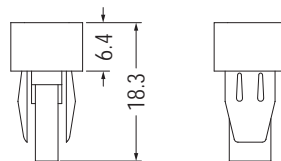

Part No.	Package
ES-1	2000



MOUNTING HOLE
THICKNESS 2.0

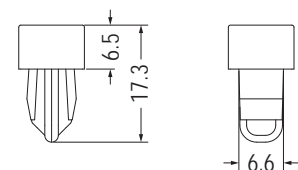

Part No.	Package
ES-2	1000

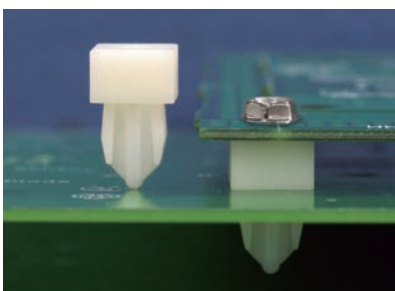

PC板間隔柱 SPACER SUPPORT

用途：配合螺絲用於PC板之固定或當螺絲固定座。

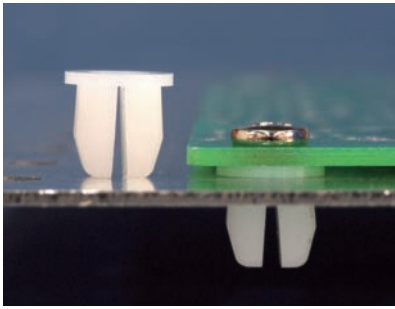

- Material: Nylon 66 (UL)
- Flame Class: 94V-2/94V-0
- Color: Natural/Black
- Unit: mm

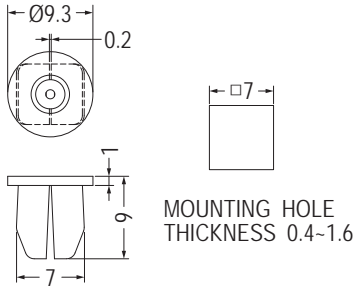

Part No.	Package
ESS-1	1000

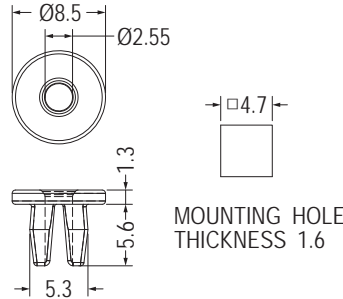

Part No.	Package
ESS-3	1000

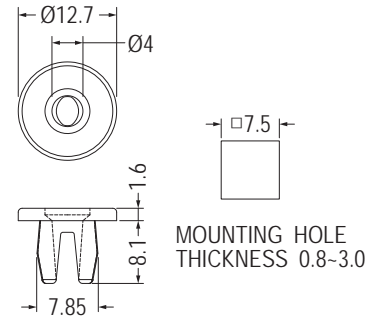

Part No.	Package
ESS-4	1000

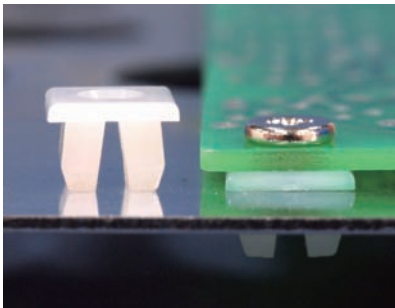

- Material: Nylon 66 (UL)
- Flame Class: 94V-2/94V-0
- Color: Natural/Black
- Unit: mm

用途：配合螺絲用於PC板之固定。

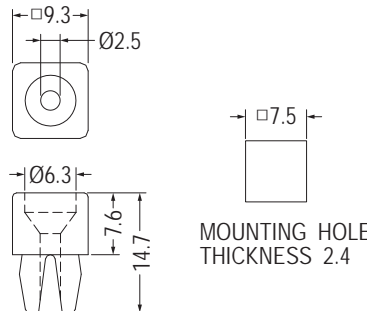

Part No.	Package
ESS-7.6	1000

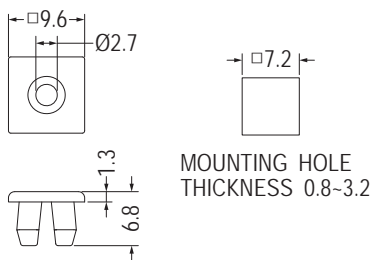

Part No.	Package
ESS-2	1000

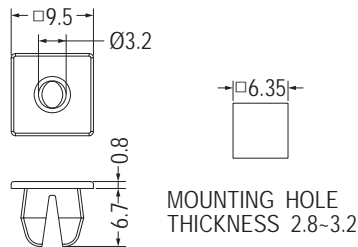

Part No.	Package
ESS-5	1000

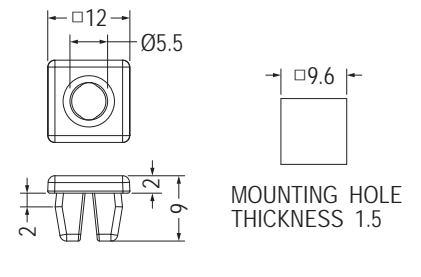

Part No.	Package
ESS6-2.5	1000

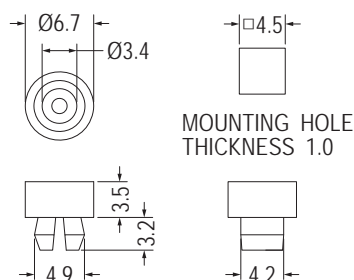
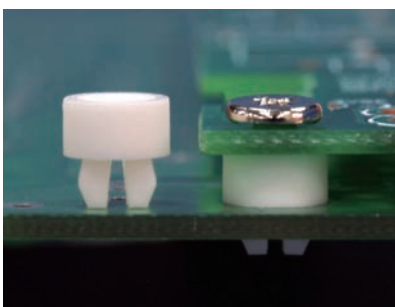

Part No.	Package
ETSA-3.5	1000

PC板間隔柱 SPACER SUPPORT

用途：配合螺絲用於PC板之固定。

1

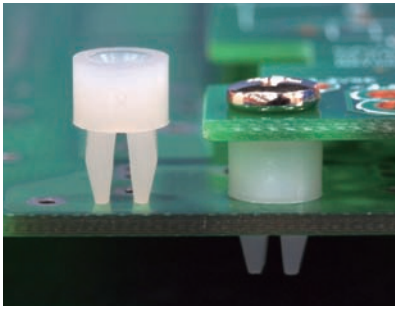

- Material: Nylon 66 (UL)
- Flame Class: 94V-2/94V-0
- Color: Natural/Black
- Unit: mm

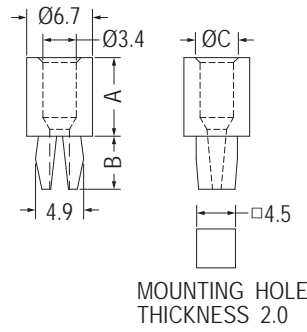

Part No.	A	B	C	Package
ETS-3	3.0	5.4	4.4	2000
ETS-3-1	3.0	5.4	5.0	
ETS-3.2	3.2	5.4	4.4	
ETS-3.2-1	3.2	5.4	5.0	
ETS-3.2-2	3.2	4.0	5.0	
ETS-3.4	3.4	5.4	4.4	
ETS-3.6	3.6	5.4	5.0	
ETS-4.6	4.6	5.4	4.4	
ETS-4.8	4.8	5.4	4.4	
ETS-6.3	6.3	5.4	4.4	
ETSS-6.5	6.5	4.0	4.4	
ETS-7M	7.0	4.0		
ETS-7	7.0	5.0		
ETS-8	8.0	5.4	4.4	
ETS-10	10.0	5.4	4.4	
ETS-12	12.7	5.4	4.4	
ETS-16	15.9	5.4	4.4	
ETS-19	19.1	5.4	4.4	

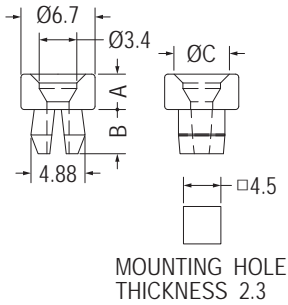

【 ETS-3.2-2 】

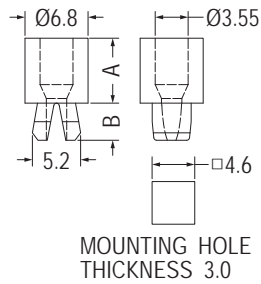

【 ETS-7M 】

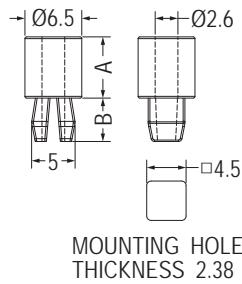

【 ETS-7 】

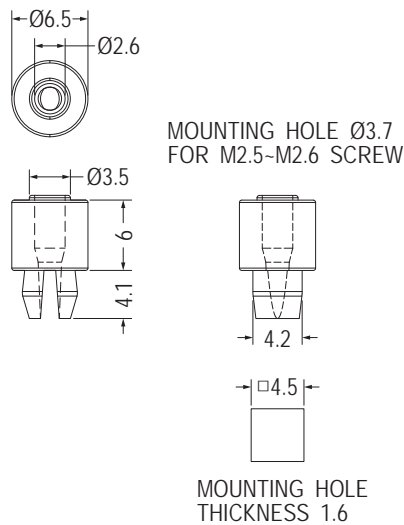
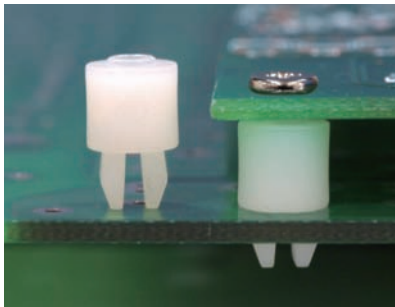

Part No.	Package
ETSB-6	1000

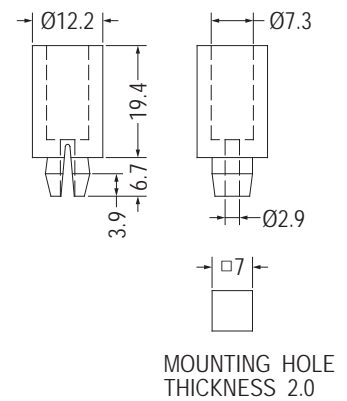

Part No.	Package
ESS-19	1000

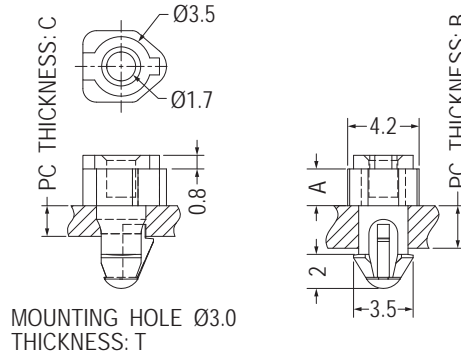
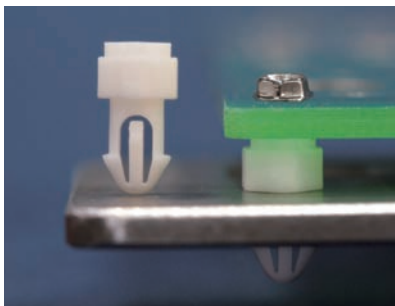
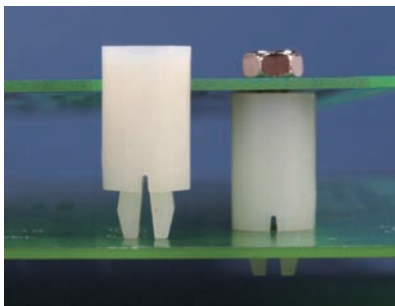

Part No.	A	B	C	T	Package
BSE-2.2	2.16	2.5	1.6	1.6-2.5	1000
BSE-2.2L	2.2	3.3	2.0	1.7-3.05	

PC板間隔柱 SPACER SUPPORT

用途：固定PC板於機板上，PC板用螺絲固定，易拆卸。

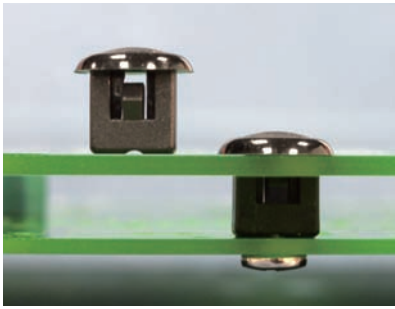

- Material: Nylon 66 (UL)
- Flame Class: 94V-2/94V-0
- Color: Natural/Black
- Unit: mm

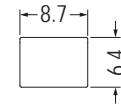
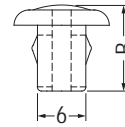
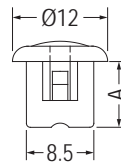

MOUNTING HOLE THICKNESS 0.8-2.0

Part No.	A	B	Package
LHC-8	8.4	10.8	1000
LHC-12	12.5	14.9	

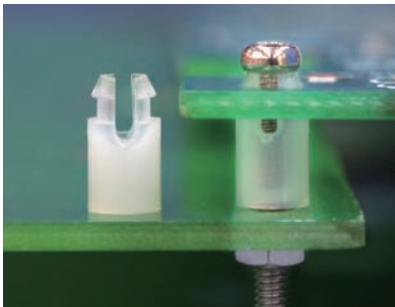

- Material: Nylon 66 (UL)
- Flame Class: 94V-2/94V-0
- Color: Natural/Black
- Unit: mm

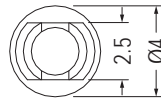

P.C.B Ø3.0 THICKNESS: T

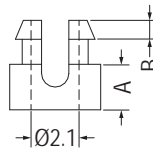

FOR M2 SCREW

P.C.B Ø3.0 THICKNESS 1.3

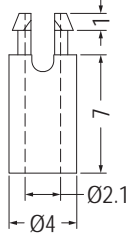

FOR M2 SCREW

Part No.	Package
SS3-7(1.3)	1000

Part No.	A	B	T	Package
SS1-2	2.0	1.2	0.8~1.0	2000
SS1-2.5	2.5	1.2	0.8~1.0	
SS1-3	3.0	1.2	0.8~1.0	
SS1-3.5	3.5	1.2	0.8~1.0	
SS1-4	4.0	1.2	0.8~1.0	
SS1-4.5	4.5	1.2	0.8~1.0	
SS1-5	5.0	1.2	0.8~1.0	
SS1-5.5	5.5	1.2	0.8~1.0	
SS1-6	6.0	1.2	0.8~1.0	
SS1-2L	2.0	1.0	1.6	
SS1-2.5L	2.5	1.0	1.6	
SS1-3L	3.0	1.0	1.6	

用途：快速固定PC板於機板上，如配合螺絲可將PC板固定於木板上。

Part No.	A	B	T	Package
SS1-2S	2.0	0.5	0.8-1.0	2000
SS1-2.5S	2.5	0.5	0.8-1.0	
SS1-3S	3.0	0.5	0.8-1.0	
SS1-3.5S	3.5	0.5	0.8-1.0	
SS1-4S	4.0	0.5	0.8-1.0	
SS1-4.5S	4.5	0.5	0.8-1.0	
SS1-5S	5.0	0.5	0.8-1.0	
SS1-5.5S	5.5	0.5	0.8-1.0	
SS1-6S	6.0	0.5	0.8-1.0	
SS1-2L	2.0	1.0	1.6	
SS1-2.5L	2.5	1.0	1.6	
SS1-3L	3.0	1.0	1.6	
SS1-3.5L	3.5	1.0	1.6	
SS1-4L	4.0	1.0	1.6	
SS1-4.5L	4.5	1.0	1.6	
SS1-5L	5.0	1.0	1.6	
SS1-5.5L	5.5	1.0	1.6	
SS1-6L	6.0	1.0	1.6	
SS1-8L	8.0	1.0	1.6	
SS1-9L	9.0	1.0	1.6	

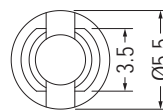
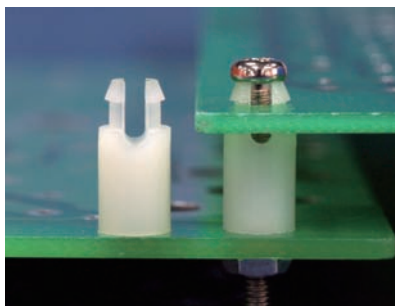

P.C.B Ø4.0 THICKNESS: T

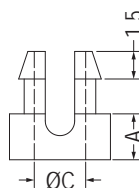

FOR SCREW

Part No.	A	C	T	Screw	Package
SS2-2.5U	2.5	2.1	1.6-1.8	M2	2000
SS2-2.5S	2.5	2.7	1.6	M2.6	
SS2-3S	3.0	2.7	1.6	M2.6	
SS2-4S	4.0	2.7	1.6	M2.6	
SS2-5S	5.0	2.7	1.6	M2.6	
SS2-6S	6.0	2.7	1.6	M2.6	
SS2-2.5	2.5	2.8	1.6-1.8	M2.6	
SS2-3	3.0	2.8	1.6-1.8	M2.6	
SS2-4	4.0	2.8	1.6-1.8	M2.6	
SS2-5	5.0	2.8	1.6-1.8	M2.6	
SS2-5.4	5.4	2.8	1.6-1.8	M2.6	
SS2-6	6.0	2.8	1.6-1.8	M2.6	
SS2-8	8.0	2.8	1.6-1.8	M2.6	
SS2-9.5	9.5	2.8	1.6-1.8	M2.6	

PC板間隔柱 SPACER SUPPORT

用途：快速固定PC板於機板上，如配合螺絲可將PC板固定於木板上。

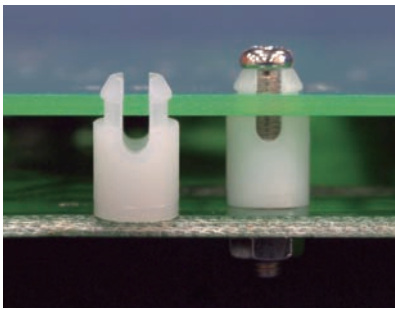

- Material: Nylon 66 (UL)
- Flame Class: 94V-2/94V-0
- Color: Natural/Black
- Unit: mm

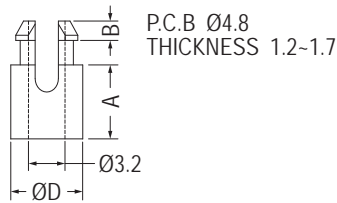

FOR M3 SCREW

P.C.B Ø4.8
THICKNESS 1.0-1.2

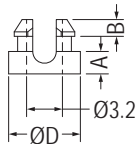

FOR M3 SCREW
【SS-2S】

P.C.B Ø4.8
THICKNESS 1.2-1.7

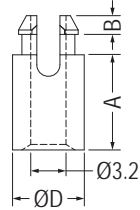

FOR M3 SCREW
【SS-10A】

Part No.	A	B	D	Package
★SS-2S	2.0	1.5	6.4	1000
SS-2.4	2.4	1.5	6.4	
SS-3	3.2	1.5	6.4	
SS-3.5	3.5	1.5	6.4	
SS-4	4.0	1.5	6.4	
SS-4.5	4.5	1.5	6.4	
SS-5	4.8	1.5	6.4	
SS-5A	5.0	1.5	6.4	
SS-6	6.4	1.5	6.4	

Part No.	A	B	D	Package
SS-7	7.0	1.5	6.5	1000
SS-7.4	7.4	1.7	6.5	
SS-8	7.9	1.5	6.4	
SS-10	9.5	1.5	6.4	
SS-10A	9.5	1.7	6.5	
SS-11	11.1	1.5	6.4	
SS-12A	12.0	1.5	6.4	
SS-12	12.7	1.5	6.4	
SS-14	14.2	1.5	6.4	
SS-14.5	14.55	1.5	6.4	
SS-15	15.0	1.5	6.4	
SS-16	15.9	1.5	6.4	
SS-17.2	17.2	1.5	6.4	
SS-19	19.1	1.5	6.4	
SS-22	22.2	1.5	6.4	500
SS-25	25.4	1.5	6.4	

P.C.B Ø4.8
THICKNESS 1.6

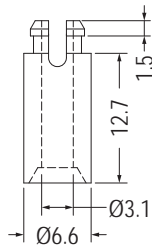

FOR M3 SCREW

Part No.	Package
SSA-12.7	1000

P.C.B Ø5.8
THICKNESS 1.6

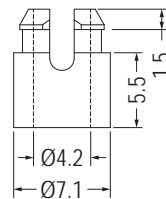

FOR M3.5 or M4 SCREW

Part No.	Package
SSA4-5.5	1000

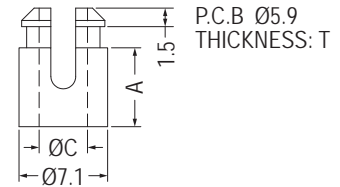

FOR M4 SCREW

Part No.	A	C	T	Package
SSU4-6.3	6.35	3.9	1.2-1.7	1000
SSU4-6.3L	6.35	4.3	1.6	
SSU4-9.5	9.5	3.9	1.2-1.7	
SSU4-9.5L	9.53	4.3	1.6	
SSU4-12.7	12.7	3.9	1.2-1.7	
★SSU4-12.7L	12.7	4.3	1.6	
SSU4-15.9	15.9	3.9	1.2-1.7	

P.C.B Ø5.9
THICKNESS 1.8

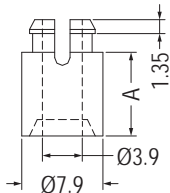

FOR M3.5 SCREW

Part No.	A	Package
SS3.5-6.3	6.3	1000
SS3.5-9.5	9.5	
SS3.5-12.7	12.7	
SS3.5-15	15.9	

P.C.B Ø5.9
THICKNESS 1.2-1.7

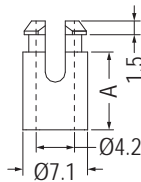

FOR M3.5 or M4 SCREW

Part No.	A	Package
SS4-3	3.0	1000
SS4-4	4.0	
SS4-4.6	4.6	
SS4-5	5.0	
SS4-6	6.4	
SS4-8	7.9	
SS4-9	9.5	
SS4-11	11.1	

P.C.B Ø5.9
THICKNESS 1.8

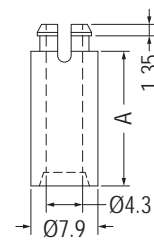

FOR M4 SCREW

【SS4-16L】

Part No.	A	Package
SS4-12S	12.0	1000
SS4-12	12.7	
SS4-16	15.9	
SS4-16L	15.9	
SS4-17	17.0	
SS4-19	19.1	
SS4-22	22.2	500
SS4-25	25.4	
SS4-30	30.0	

P.C.B Ø6.0
THICKNESS 1.6

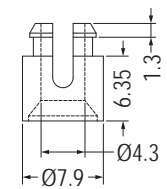

FOR M4 SCREW

Part No.	Package
SSUA4-6.3L	1000

PC板間隔柱 SPACER SUPPORT

用途：直接壓入板內固定。

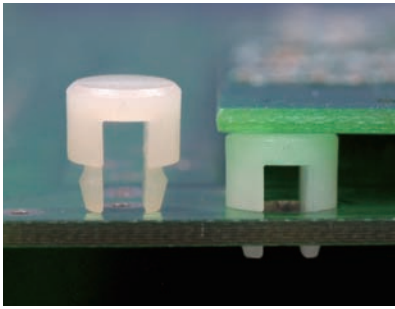

- Material: Nylon 66 (UL)
- Flame Class: 94V-2/94V-0
- Color: Natural/Black
- Unit: mm

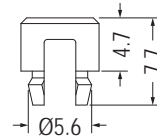

CHASSIS Ø5.0
THICKNESS 0.8

Part No.	Package
CUS-5	2000

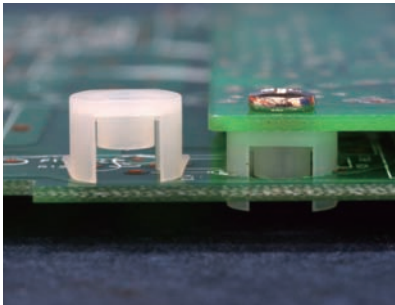

- Material: Nylon 66 (UL)
- Flame Class: 94V-2/94V-0
- Color: Natural/Black
- Unit: mm

用途：一頭直接壓入機板固定，另一頭用螺絲貫穿固定於機板，一般用於DVD內部之PC板固定。

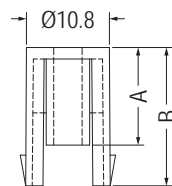
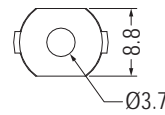

依照使用者的螺絲大小挖孔

(Hole must be based on the size of your screw)



MOUNTING HOLE

Part No.	A	B	Package
DVDS-5	5.0	7.8	500
DVDS-9	9.4	14.7	
DVDS-12	12.7	18.1	

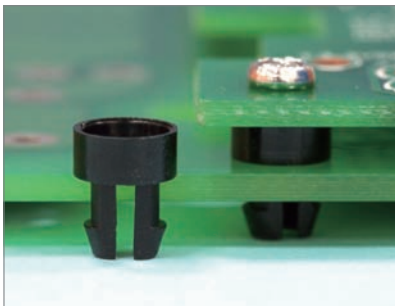

- Material: Nylon 66 (UL)
- Flame Class: 94V-2/94V-0
- Color: Natural/Black
- Unit: mm

用途：用於機器之面板固定，配合螺絲使用。

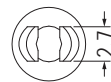
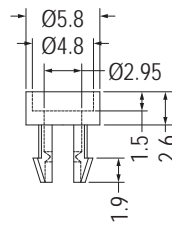

CHASSIS Ø4.0
THICKNESS 2.3-2.5

Part No.	Package
SOR-2	2000

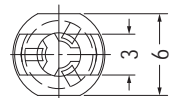
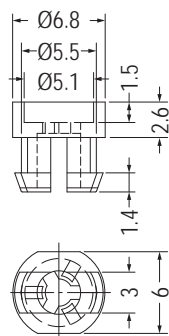
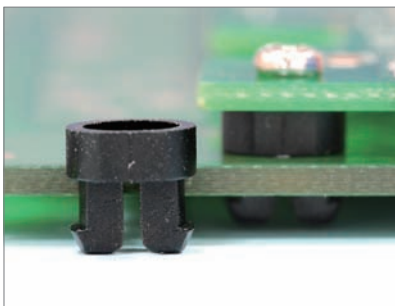

CHASSIS Ø5.5
THICKNESS 2.3-2.5

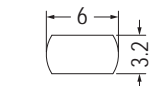
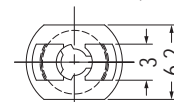
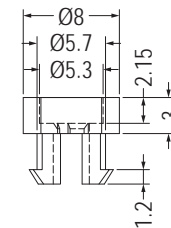

MOUNTING HOLE
THICKNESS 2.8

FOR M2.5 or M2.6 SCREW

Part No.	Package
SOR-1	2000

Part No.	Package
SOR-3	2000

PC板間隔柱 SPACER SUPPORT

用途：固定PC板於機板上，免工具，易拆卸。



- Material: Nylon 66 (UL)
- Flame Class: 94V-2/94V-0
- Color: Natural/Black
- Unit: mm

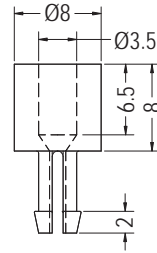

CHASSIS Ø3.5
THICKNESS 5.5

Part No.	Package
SSUL-8	1000

1

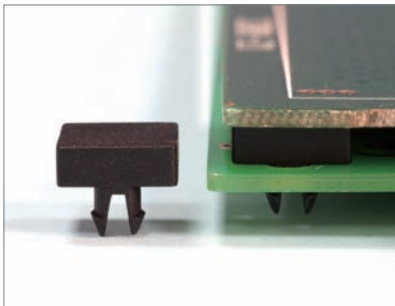

- Material: Nylon 66 (UL)
- Flame Class: 94V-2/94V-0
- Color: Natural/Black
- Unit: mm

用途：用於PC板墊高及支撐。

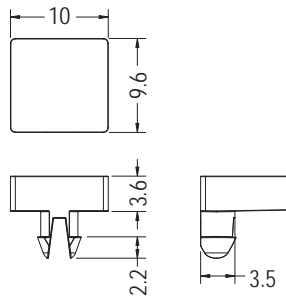

P.C.B Ø3.8
THICKNESS 2.5

Part No.	Package
LIES-1	1000

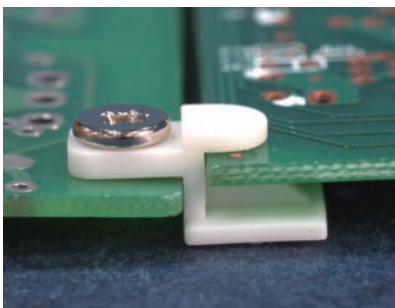

- Material: Nylon 66 (UL)
- Flame Class: 94V-2/94V-0
- Color: Natural/Black
- Unit: mm

用途：用於主機板或PC板固定。

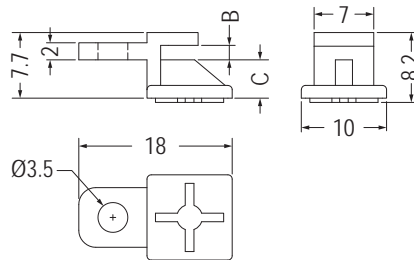

Part No.	B	C	Package
UBD-1	1.7	4.5	1000
UBD-2	2.0	4.15	

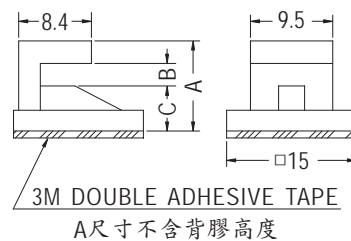
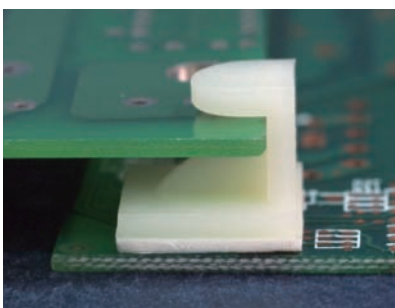

Part No.	A	B	C	Package
UB-6A	10.4	2.6	5.1	1000
UB-8A	11.9	2.4	7.0	
UB-10A	14.1	2.5	9.1	
UB-11A	15.0	2.5	10.0	
UB-12A	16.1	2.5	11.1	

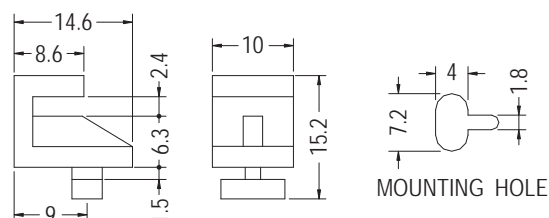

Part No.	Package
UB-6E	1000

PC板間隔柱 SPACER SUPPORT

用途：用於主機板或PC板固定。

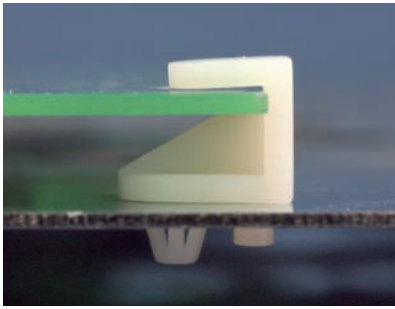

- Material: Nylon 66 (UL)
- Flame Class: 94V-2/94V-0
- Color: Natural/Black
- Unit: mm

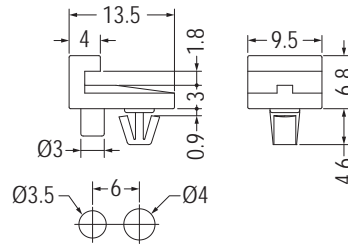

MOUNTING HOLE THICKNESS 0.8

Part No.	Package
UB-3S	1000

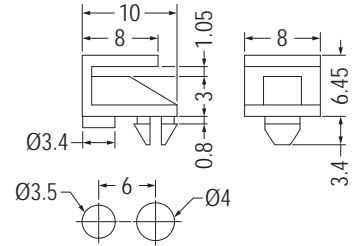

MOUNTING HOLE THICKNESS 0.8

Part No.	Package
UB-4	1000

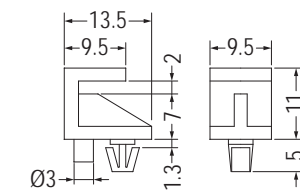

MOUNTING HOLE THICKNESS 1.0

Part No.	Package
UB-6	1000

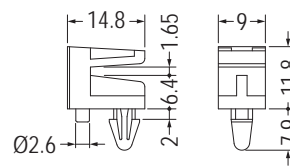

MOUNTING HOLE THICKNESS 1.6

Part No.	Package
UB-6D	1000

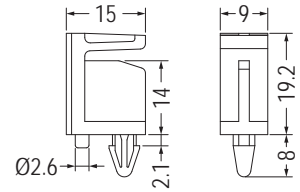

MOUNTING HOLE THICKNESS 1.6

Part No.	Package
UB-14D	1000

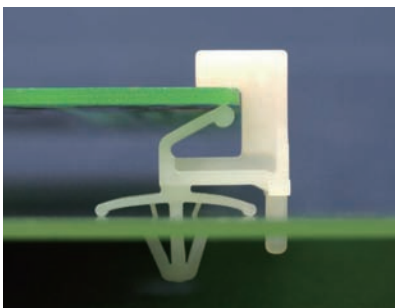

- Material: Nylon 66 (UL)
- Flame Class: 94V-2/94V-0
- Color: Natural/Black
- Unit: mm

用途：支撐PC板，使中間不致震動，載重而凹陷短路。

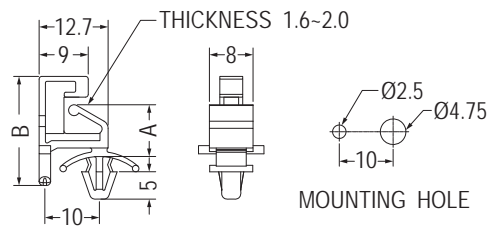

CHASSIS Ø4.8 THICKNESS 0.8-2.0

Part No.	A	B	Package
WLCF-6	6.3	16.8	1000
WLCF-8	8.0	18.5	
WLCF-9	9.5	20.0	
WLCF-12	12.7	23.2	
WLCF-16	15.9	26.4	

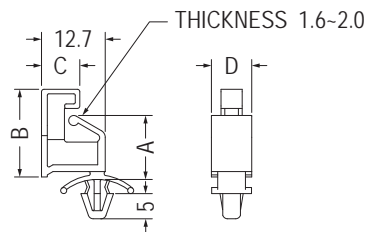
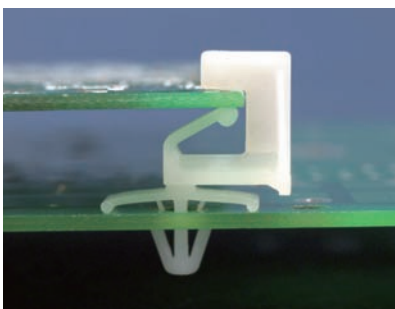

CHASSIS Ø4.8 THICKNESS 0.8-2.0

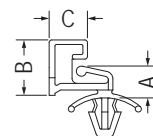

【 ULCF-6-ULCF-8S 】

Part No.	A	B	C	D	Package
ULCF-6	6.3	11.0	9.0	8.0	1000
ULCF-8	8.0	12.7	9.0	8.0	
ULCF-8S	8.0	12.7	7.6	6.0	
ULCF-9	9.5	14.2	9.0	8.0	
ULCF-12	12.7	17.4	9.0	8.0	
ULCF-16	15.9	20.6	9.0	8.0	

PC板間隔柱 SPACER SUPPORT

1

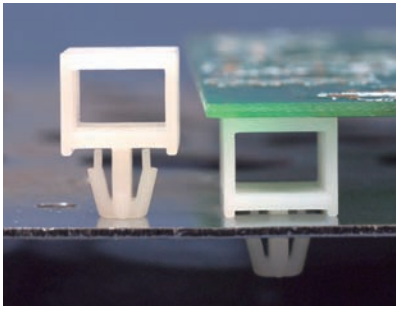

- Material: Nylon 66 (UL)
- Flame Class: 94V-2/94V-0
- Color: Natural/Black
- Unit: mm

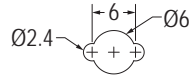
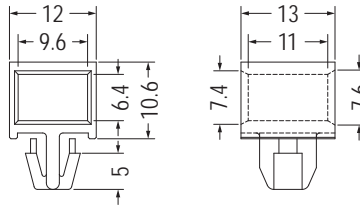

MOUNTING HOLE THICKNESS: T

Part No.	T	Package
LDD-10	1.6-1.8	500
LDD-10(2)	1.8-2.0	

用途：固定PC板於機板上，維修方便不佔空間。

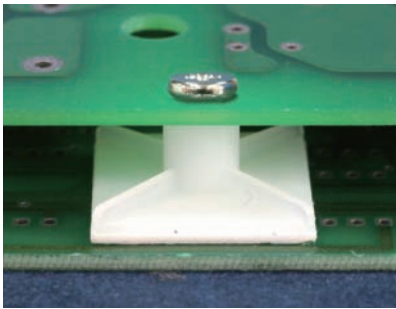

- Material: Nylon 66 (UL)
- Flame Class: 94V-2/94V-0
- Color: Natural/Black
- Unit: mm

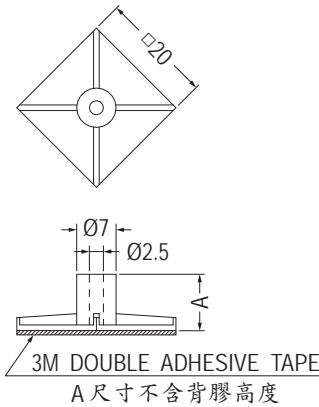

用途：背膠式，用於不能鑽孔之機板與PC板間之固定，配合螺絲使用，拆卸方便。

Part No.	A	Package
ASR-5	4.2	500
ASR-6	5.6	
ASR-7	6.2	
ASR-8	7.2	
ASR-9	8.2	
ASR-11	10.0	
ASR-12.7	11.9	
ASR-14.5	13.6	
ASR-15.9	15.1	
ASR-17.5	16.3	
ASR-19.1	18.3	

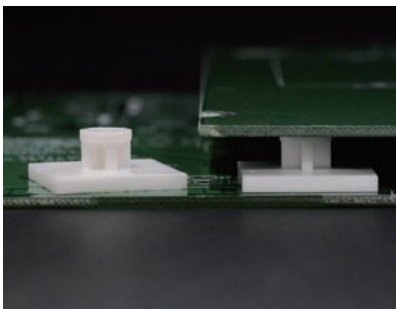

- Material: Nylon 66 (UL)
- Flame Class: 94V-2/94V-0
- Color: Natural/Black
- Unit: mm

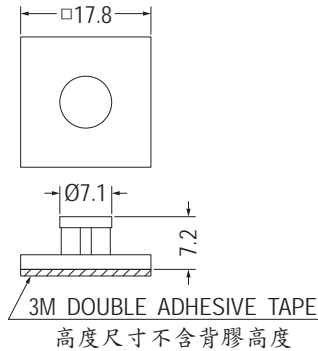

用途：背膠式，用於不能鑽孔之機板與PC板間之固定。

Part No.	Package
AST-7.2	500

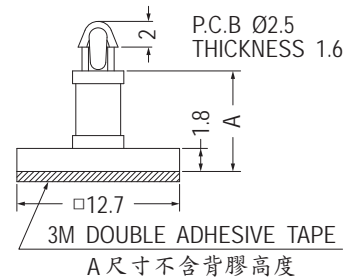
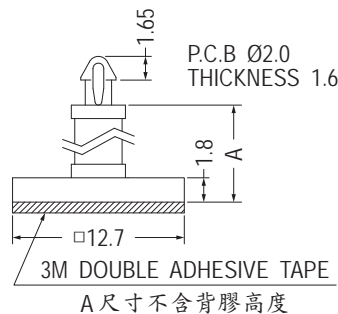
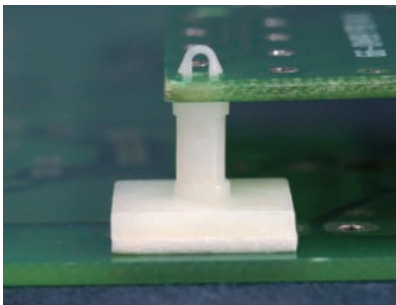

Part No.	A	Package
ISS-4.8	4.0	1000
ISS-6.4	5.6	
ISS-8	7.2	
ISS-9.5	8.7	
ISS-11.1	10.3	
ISS-12.7	11.9	
ISS-15.9	15.1	
ISS-19.1	18.3	

Part No.	A	Package
GSS-4.8	4.0	1000
GSS-6.4	5.6	
GSS-8	7.2	
GSS-9.5	8.7	
GSS-11.1	10.3	
GSS-12.7	11.9	
GSS-14.3	13.5	
GSS-15.9	15.1	
GSS-19.1	18.3	

PC板間隔柱 SPACER SUPPORT

用途：背膠式，用於不能鑽孔之機板與PC板間之固定。

- Material: Nylon 66 (UL)
- Flame Class: 94V-2/94V-0
- Color: Natural/Black
- Unit: mm

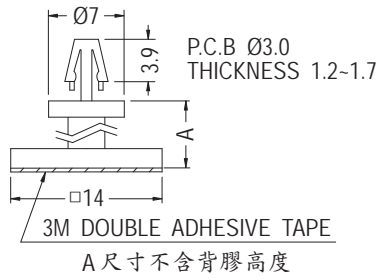
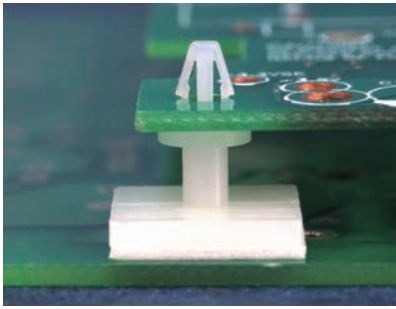

• Patented (專利品)

Part No.	A	Package
BSS-6	5.6	1000
BSS-9	8.0	
BSS-12	11.9	

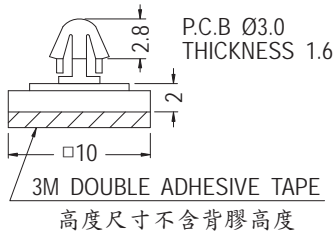

Part No.	Package
CSSA-2	1000

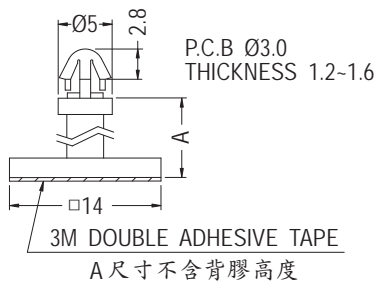

Part No.	A	Package
CSS-3.5	2.7	1000
CSS-5	4.0	
CSS-6.4	5.6	
CSS-8	7.2	
CSS-10	9.2	
CSS-11	9.7	
CSS-12.7	11.9	

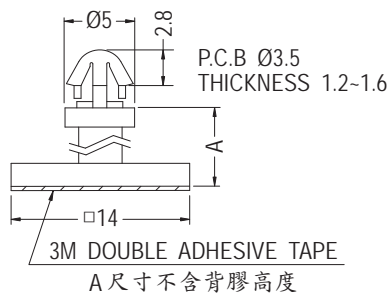
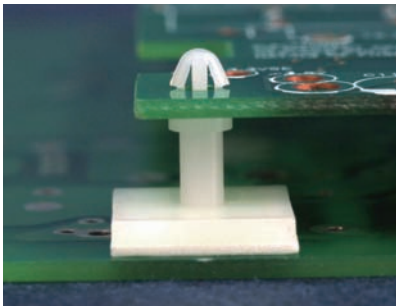

Part No.	A	Package
FSS-3.5	2.7	1000
FSS-5	4.0	
FSS-6.4	5.6	
FSS-8	7.2	
FSS-10	9.2	
FSS-12.7	11.9	

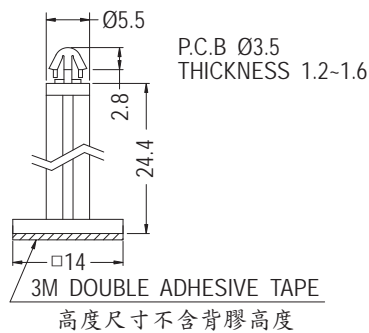
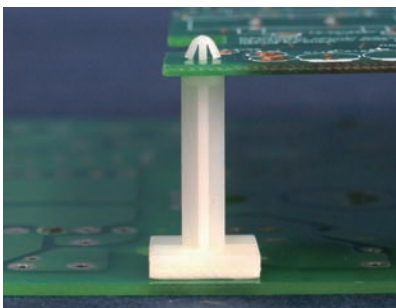

Part No.	Package
FSL-25	1000

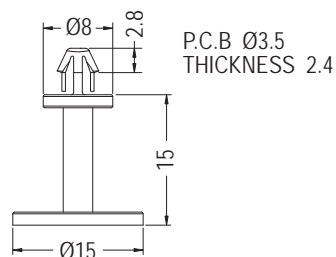

Part No.	Package
FSSA-15	1000

PC板間隔柱 SPACER SUPPORT

用途：背膠式，用於不能鑽孔之機板與PC板間之固定。

1

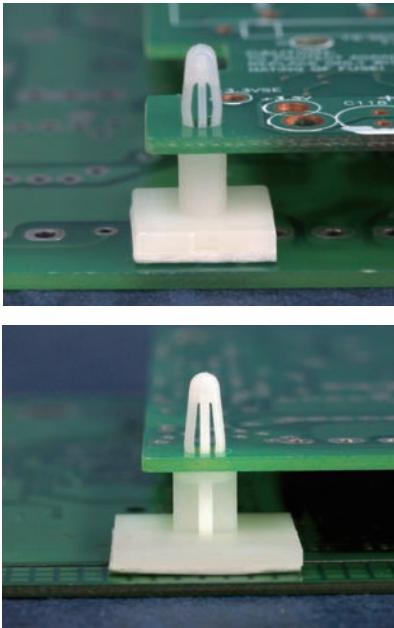

- Material: Nylon 66 (UL)
- Flame Class: 94V-2/94V-0
- Color: Natural/Black
- Unit: mm

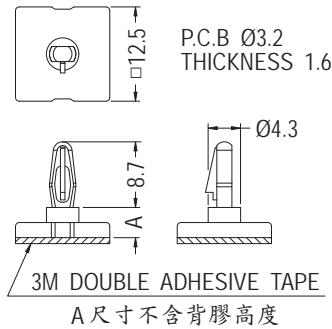

Part No.	A	Package
JSS-4.8	4.0	500
JSS-6.4	5.6	
JSS-7.9	6.8	
JSS-8.4	7.5	
JSS-9.5	8.5	
JSS-11	10.6	
JSS-12.7	11.7	
JSS-15.9	15.0	

• 背膠高度以0.9為標準

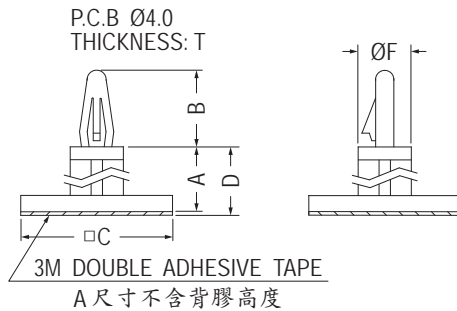

Part No.	A	B	C	D	F	T	Package
ASS-5	4.6	10.0	20.0	5.5	7.0	1.2~1.7	500
ASS-6	5.5	10.0	20.0	6.4	7.0	1.2~1.7	
ASS-6L	5.5	10.2	17.8	6.4	6.9	1.2~1.6	
ASS-8	7.2	10.0	20.0	8.1	7.0	1.2~1.7	
★ASS-9.5L	8.6	10.2	17.8	9.5	7.0	1.2~1.6	
ASS-10	9.0	10.0	20.0	9.9	7.0	1.2~1.7	
ASS-12.7L	11.8	10.2	18.0	12.7	6.9	1.2~1.6	
ASS-12	12.0	10.0	20.0	12.9	7.0	1.2~1.7	
ASS-15	15.4	10.0	20.0	16.3	7.0	1.2~1.7	
ASS-15.3S	15.3	8.0	17.8	16.2	7.1	1.2~1.6	
ASS-15.9L	15.0	10.2	18.0	15.9	6.9	1.2~1.6	
ASS-18.5	18.5	10.0	18.0	19.4	6.8	1.2~2.0	

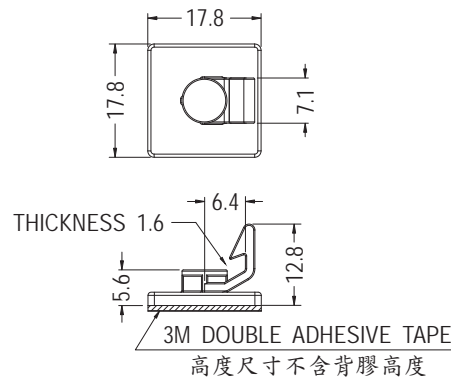
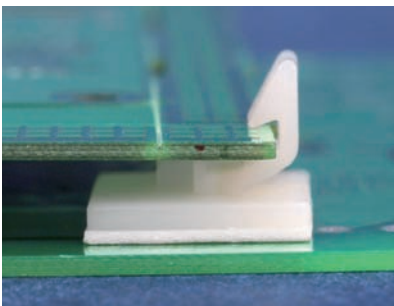

Part No.	Package
ULCK-6.4	1000



- Material: Nylon 66 (UL)
- Flame Class: 94V-2/94V-0
- Color: Natural/Black
- Unit: mm

用途：PC板直接壓入固定，另一頭用螺絲固定，省時易拆卸。

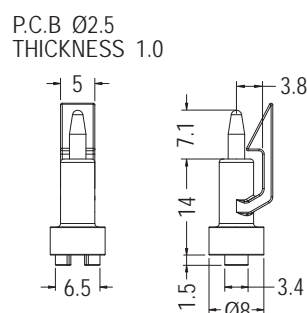

Part No.	Package
ULCI-11	1000

PC板間隔柱 SPACER SUPPORT

用途：PC板直接壓入固定，另一頭用螺絲固定，省時易拆卸。



- Material: Nylon 66 (UL)
- Flame Class: 94V-2/94V-0
- Color: Natural/Black
- Unit: mm

P.C.B Ø2.5
THICKNESS 1.0

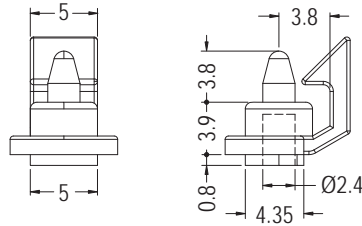

Part No.	Package
ULCIJ-4	1000



P.C.B Ø3.3
THICKNESS 1.0

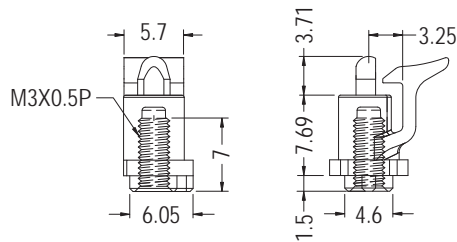

Part No.	Package
ULCD-7.8	1000

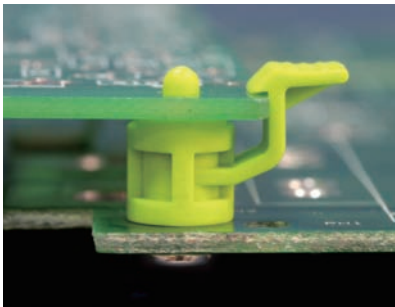

P.C.B Ø3.3
THICKNESS 1.6

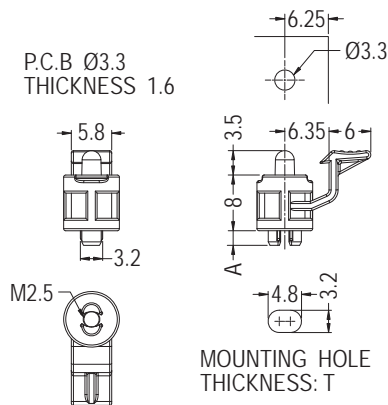

- Color: Natural/Black/Green

Part No.	A	T	Package
ULCH-2	2.1	2.16	1000
ULCH-2S	1.5	1.6	

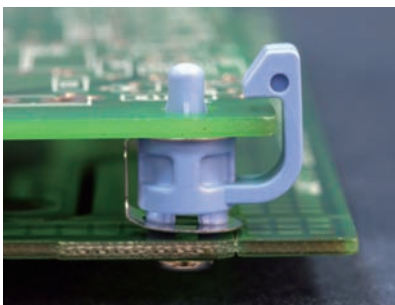

- Material: Nylon 66 (UL)
- Ground Terminal Material: SPTE
- Flame Class: 94V-2/94V-0
- Color: Natural/Black/Blue
- Unit: mm

用途：PC板與PC板之固定，加強導電幫助接地，不佔空間。

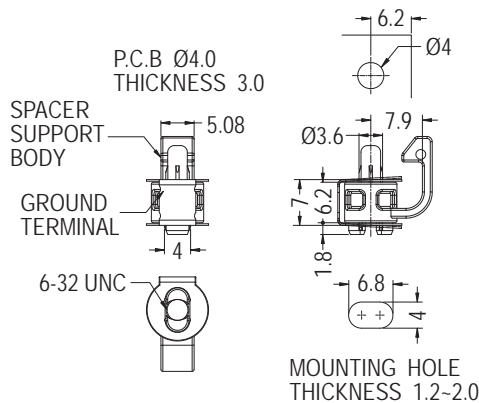

Part No.	Package
ULCH-1	1000

PC板間隔柱 SPACER SUPPORT

用途：PC板直接壓入固定，另一頭用螺絲固定，省時易拆卸。

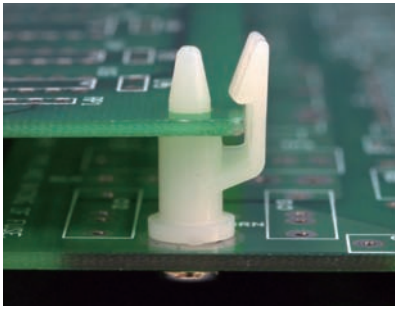

- Material: Nylon 66 (UL)
- Flame Class: 94V-2/94V-0
- Color: Natural/Black
- Unit: mm

P.C.B Ø4.0
THICKNESS 1.2-1.6

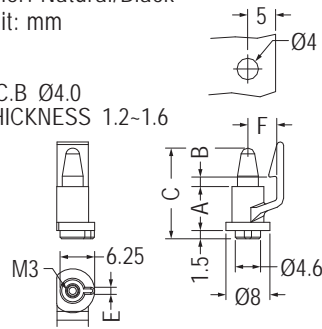

Part No.	A	B	C	E	F	Package
ULCC-6	6.3	1.73	14.8	1.3	5.25	500
ULCC-8	8.0	1.7	16.5	1.3	5.25	
ULCC-10	10.0	2.24	19.0	1.4	5.25	
ULCC-12	12.0	1.75	19.8	1.4	5.25	
ULCC-19	18.55	1.9	27.05	1.3	5.5	

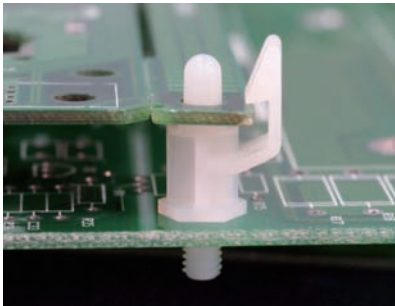

- Material: Nylon 66 (UL)
- Flame Class: 94V-2/94V-0
- Color: Natural/Black
- Unit: mm

MOUNTING HOLE
THICKNESS 1.6

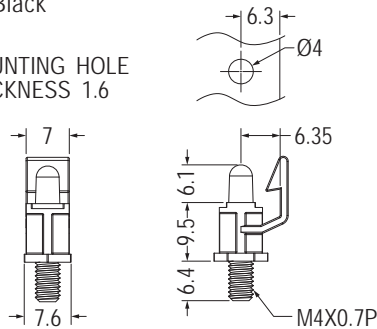

Part No.	Package
ULCBM4-9.5	1000



- Material: Nylon 66 (UL)
- Flame Class: 94V-2/94V-0
- Color: Natural/Black
- Unit: mm

P.C.B Ø3.3
THICKNESS 1.57

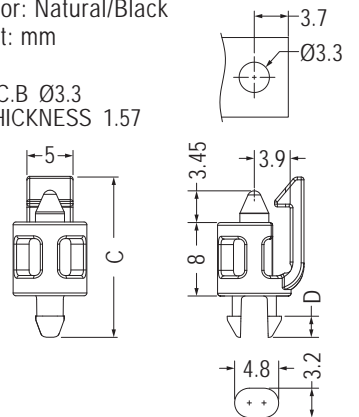

MOUNTING HOLE
THICKNESS: T

用途：PC板直接壓入固定，另一頭直接壓入機板固定，省時易拆裝。

Part No.	C	D	T	Package
ULCSA-8	17.45	2.3	2.13	1000
ULCSA-8S	16.5	1.9	1.57	



P.C.B Ø3.3
THICKNESS 1.57

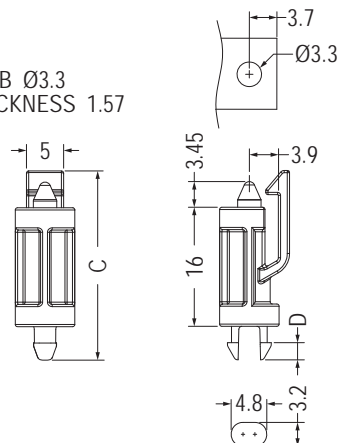

MOUNTING HOLE
THICKNESS: T

Part No.	C	D	T	Package
ULCSA-16	25.45	2.3	2.13	1000
ULCSA-16S	24.5	1.9	1.57	

PC板間隔柱 SPACER SUPPORT

用途：PC板直接壓入固定，另一頭直接壓入機板固定，省時易拆裝。

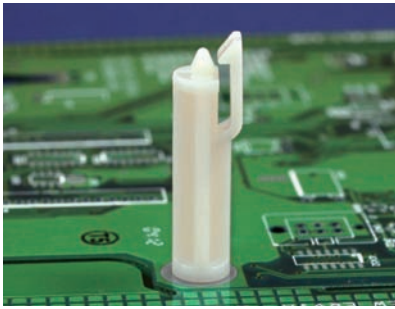

- Material: Nylon 66 (UL)
- Flame Class: 94V-2/94V-0
- Color: Natural/Black
- Unit: mm

P.C.B Ø3.3
THICKNESS 1.57

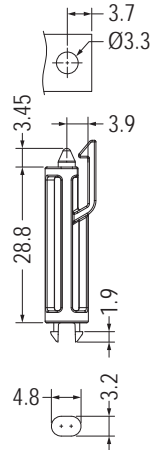

MOUNTING HOLE
THICKNESS 1.57

Part No.	Package
ULCSA-28.8S	500

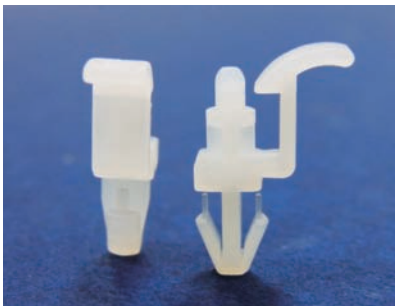

P.C.B Ø2.35
THICKNESS 1.0

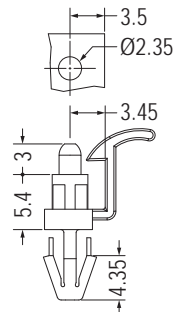
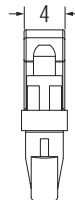

CHASSIS Ø4.0
THICKNESS 2.4

Part No.	Package
ULCBA-5	1000



HOLE IN P.C.B
THICKNESS 1.3

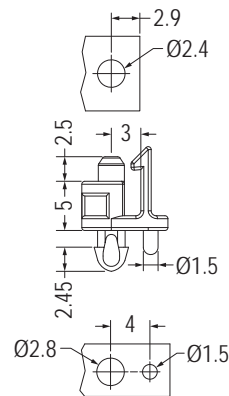

MOUNTING HOLE
THICKNESS 1.7

Part No.	Package
ULCSD-5	1000

HOLE IN P.C.B
THICKNESS: E

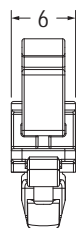

HOLE IN P.C.B
THICKNESS: T

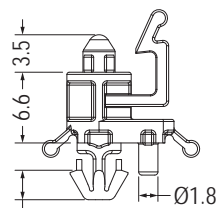
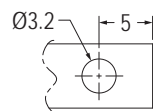

Part No.	E	T	Package
ULCSF-6.6	1.6	1.93	1000
ULCSF-6.6L	1.4~1.8	2.3~2.7	
ULCSF-6.6XL	1.4~1.8	2.52~3.08	
ULCSF-6.6XXL	1.4~1.8	2.83~3.47	

PC板間隔柱 SPACER SUPPORT

用途：PC板直接壓入固定，另一頭直接壓入機板固定，省時易拆裝。

- Material: Nylon 66 (UL)
- Flame Class: 94V-2/94V-0
- Color: Natural/Black/Blue
- Unit: mm

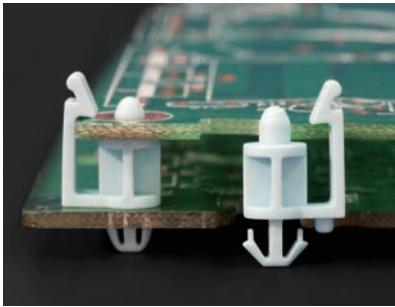

HOLE IN P.C.B
THICKNESS 1.6

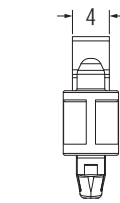

MOUNTING HOLE
THICKNESS 2.0

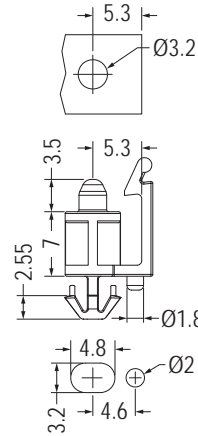

Part No.	Package
ULCSE-7	1000

HOLE IN P.C.B
THICKNESS 1.6

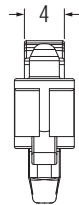

MOUNTING HOLE
THICKNESS: T

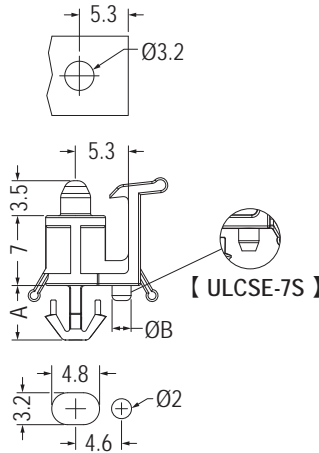

Part No.	A	B	T	Package
ULCSE-7S	4.35	1.8	1.6	1000
ULCSE-7L	5.0	1.9	2.34	
ULCSE-7L1	5.45	1.9	2.4	

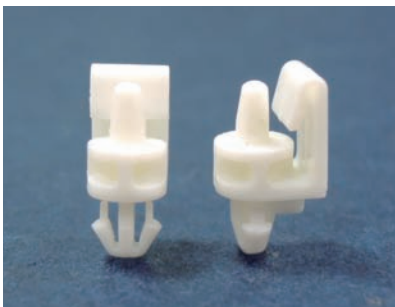

P.C.B Ø2.6
THICKNESS 0.8-1.0

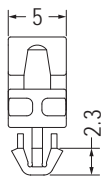

MOUNTING HOLE
THICKNESS 1.4-1.6

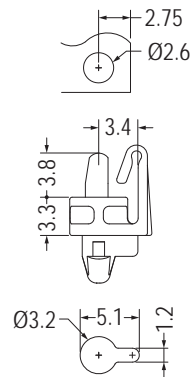

Part No.	Package
LCUE-3.3	2000



P.C.B Ø3.4
THICKNESS 1.2



MOUNTING HOLE
THICKNESS 1.6

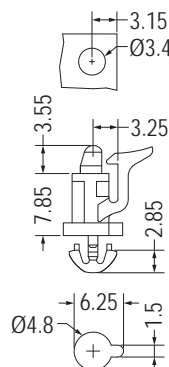

P.C.B Ø4.0
THICKNESS 0.8-1.6

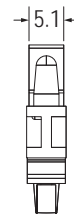

CHASSIS Ø4.0
THICKNESS 0.8-2.0

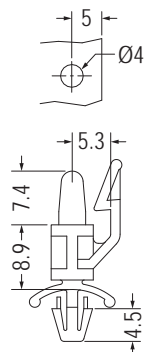

Part No.	Package
ULCBA-7.8	1000

Part No.	Package
ULCE-9	1000

PC板間隔柱 SPACER SUPPORT

用途：用於不能鑽孔之機板與PC板間之固定。

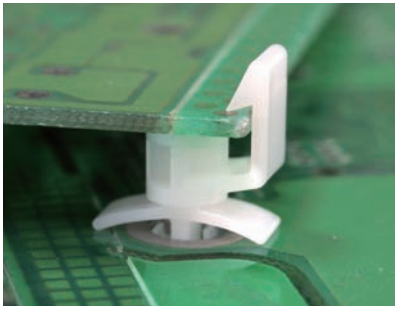

- Material: Nylon 66 (UL)
- Flame Class: 94V-2/94V-0
- Color: Natural/Black
- Unit: mm

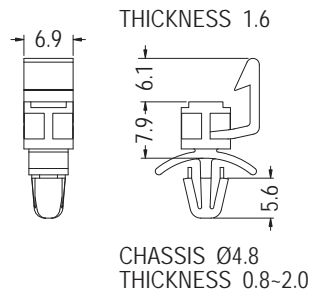

Part No.	Package
ULCCB-7.9	1000

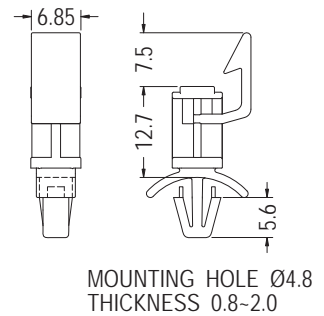

Part No.	Package
ULCCB-12.7L	1000



- Material: Nylon 66 (UL)
- Flame Class: 94V-2/94V-0
- Color: Natural/Black/Blue
- Unit: mm

用途：支撐PC板，使中間不致震動，載重而凹陷短路。

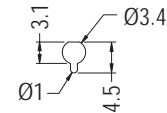
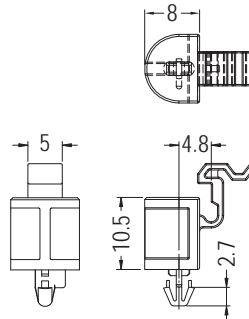

MOUNTING HOLE THICKNESS 2.4

Part No.	Package
LCUA-11	1000



- Material: Nylon 66 (UL)
- Flame Class: 94V-2/94V-0
- Color: Natural/Black/Green
- Unit: mm

用途：PC板直接壓入固定，另一頭直接壓入機板固定，省時易拆裝。

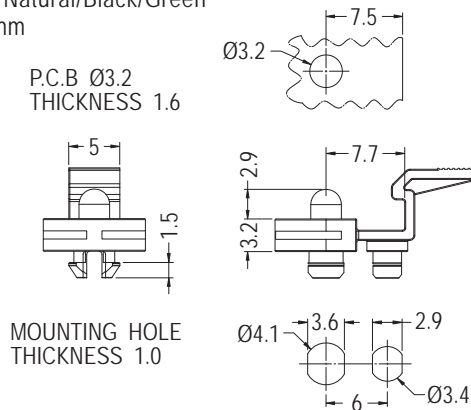

Part No.	Package
LCUAD-1	1000



- Material: Nylon 66 (UL)
- Flame Class: 94V-2/94V-0
- Color: Natural/Black
- Unit: mm

P.C.B Ø4.0 THICKNESS 1.6

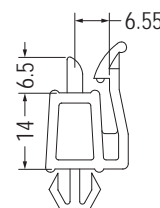
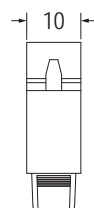

MOUNTING HOLE THICKNESS 0.8-2.4

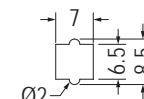

Part No.	Package
KES-15	500

PC板間隔柱 SPACER SUPPORT

用途：PC板直接壓入固定，另一頭直接壓入機板固定，省時易拆裝。

- Material: Nylon 66 (UL)
- Flame Class: 94V-2/94V-0
- Color: Natural/Black
- Unit: mm

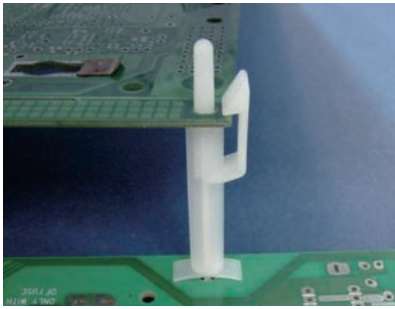

P.C.B Ø4.0
THICKNESS 1.6

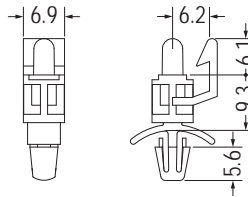

CHASSIS Ø4.8
THICKNESS 1.6-2.2

Part No.	Package
ULCB-9S	500

P.C.B Ø4.0
THICKNESS 1.6

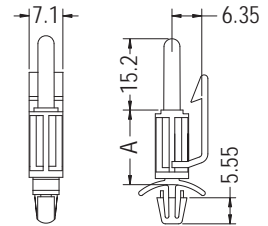

CHASSIS Ø4.8
THICKNESS 1.6

Part No.	A	Package
ULCB-15	15.9	500
ULCB-38	38.1	

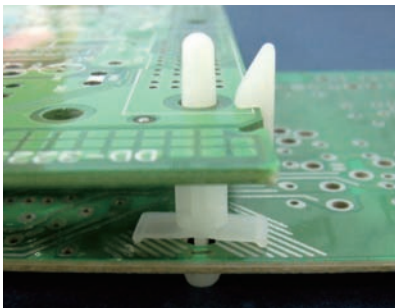

P.C.B Ø4.0
THICKNESS 1.6~1.8

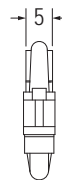

CHASSIS Ø4.8
THICKNESS 0.5-2.0

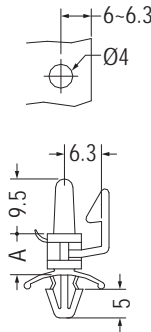

Part No.	A	Package
ULCB-6	6.3	1000
ULCB-8	8.0	
ULCB-9	9.5	
ULCB-10	10.0	
ULCB-12	12.7	
ULCB-16	15.9	
ULCB-19.1	19.1	
ULCB-23	23.0	

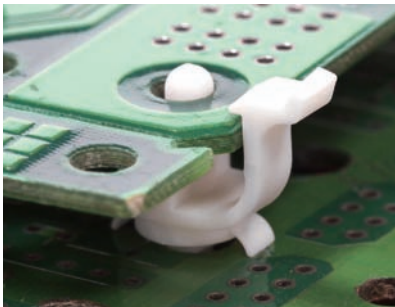

THICKNESS 1.6

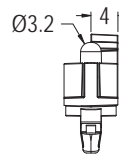

MOUNTING HOLE
THICKNESS 1.8-2.2

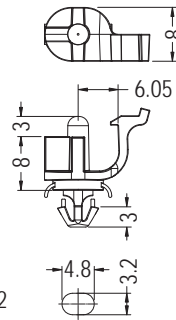

THICKNESS 1.6

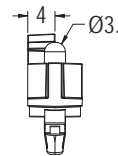

MOUNTING HOLE
THICKNESS 1.8-2.2

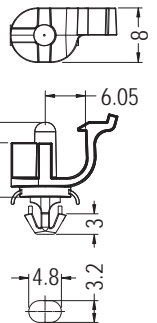

- Color: Natural/Black/Green/Gary

Part No.	Package
LCUAC-2L	1000

Part No.	Package
LCUAC-2R	1000

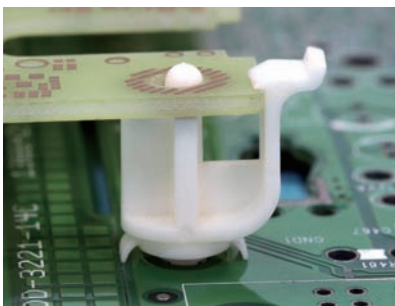

THICKNESS 1.6

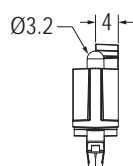

MOUNTING HOLE
THICKNESS 2.2-2.5

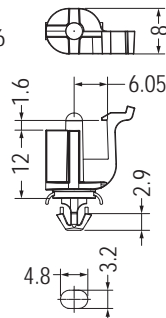

THICKNESS 1.6

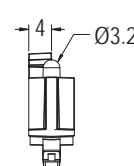

MOUNTING HOLE
THICKNESS 2.2-2.5

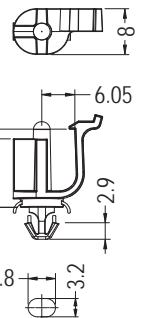

Part No.	Package
LCUAC-3L	1000

Part No.	Package
LCUAC-3R	1000

PC板間隔柱 SPACER SUPPORT

用途：PC板直接壓入固定，另一頭直接壓入機板固定，省時易拆裝。

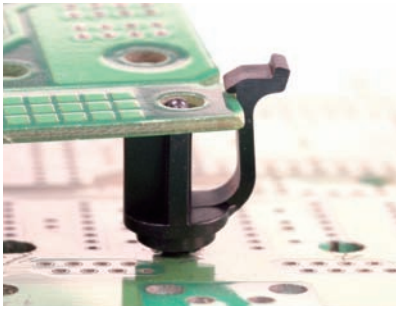

- Material: Nylon 66 (UL)
- Flame Class: 94V-2/94V-0
- Color: Natural/Black
- Unit: mm

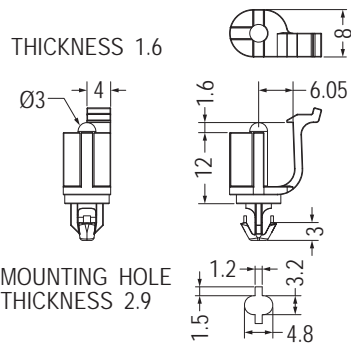

Part No.	Package
LCUAC-7L	1000

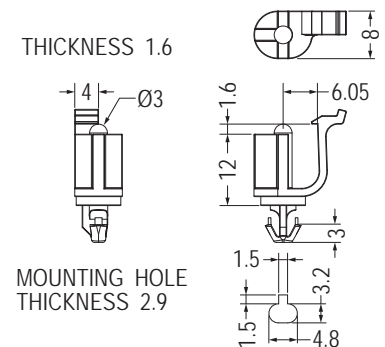

Part No.	Package
LCUAC-7R	1000

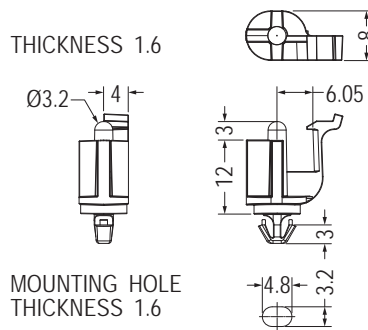

Part No.	Package
LCUAC-8L	1000

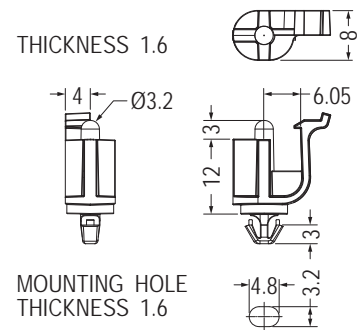

Part No.	Package
LCUAC-8R	1000

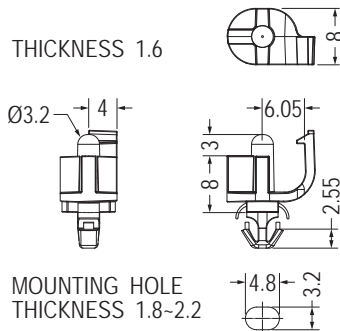

Part No.	Package
LCUAC-9L	1000

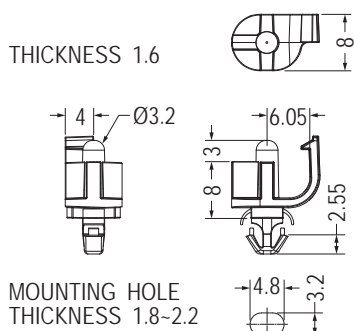

Part No.	Package
LCUAC-9R	1000

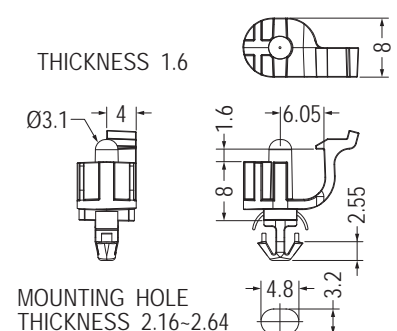

Part No.	Package
LCUAC-11L	1000

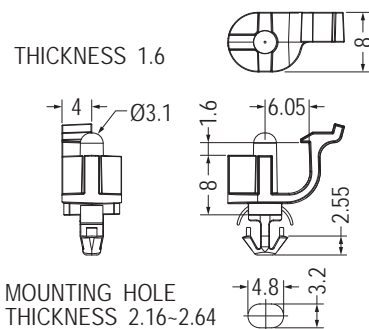

Part No.	Package
LCUAC-11R	1000

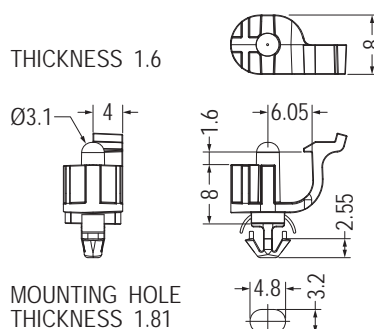

Part No.	Package
LCUAE-8L	1000

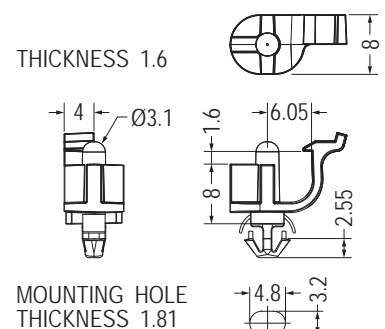

Part No.	Package
LCUAE-8R	1000

PC板間隔柱 SPACER SUPPORT

用途：PC板直接壓入固定，另一頭直接壓入機板固定，省時易拆裝。

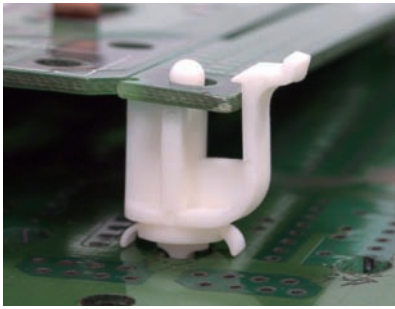

- Material: Nylon 66 (UL)
- Flame Class: 94V-2/94V-0
- Color: Natural/Black
- Unit: mm

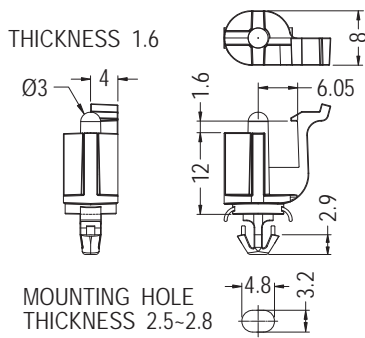

Part No.	Package
LCUAE-12L	1000

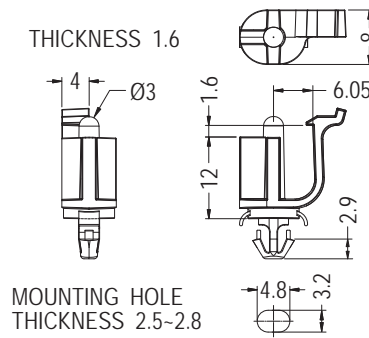

Part No.	Package
LCUAE-12R	1000

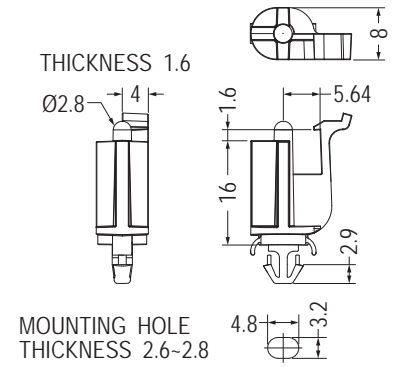

Part No.	Package
LCUAE-16LA	1000

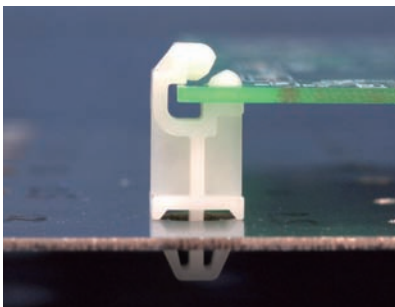

- Material: Nylon 66 (UL)
- Flame Class: 94V-2/94V-0
- Color: Natural/Black
- Unit: mm

用途：用於PC板固定及墊高，拆卸方便。

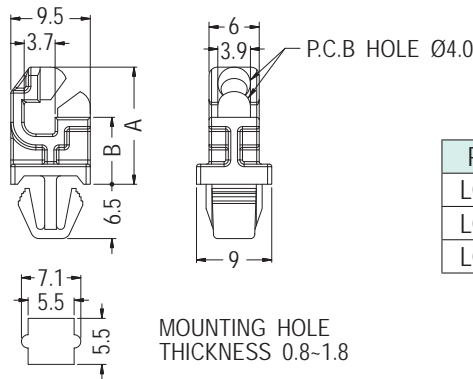

Part No.	A	B	Package
LCMM-8	14.0	8.0	1000
LCMM-12	18.0	12.0	
LCMM-18	24.0	18.0	

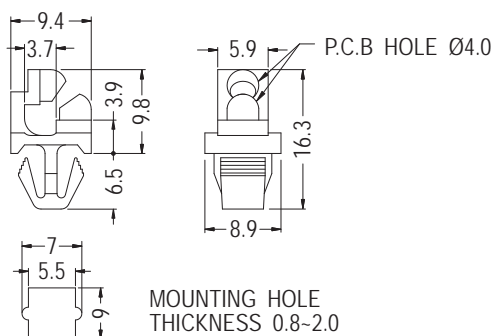
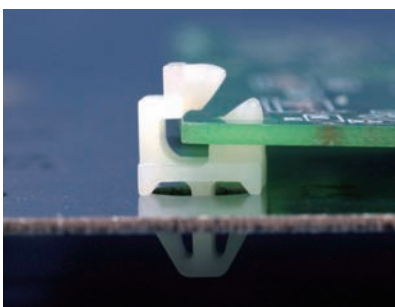

Part No.	Package
LCMM-4	1000

PC板間隔柱 SPACER SUPPORT

用途：將PC板固定於機殼上，PC板可前後30°移動。



- Material: Nylon 66 (UL)
- Flame Class: 94V-2/94V-0
- Color: Natural/Black
- Unit: mm

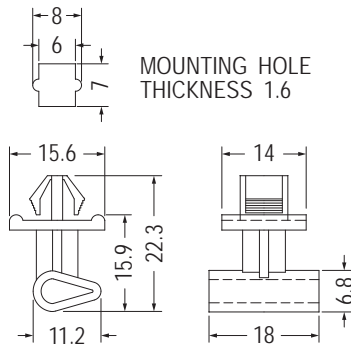

Part No.	Package
PS-16	500

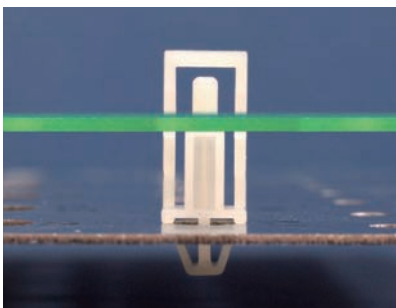

- Material: Nylon 66 (UL)
- Flame Class: 94V-2/94V-0
- Color: Natural/Black
- Unit: mm

用途：用於PC板固定及墊高，拆卸方便。

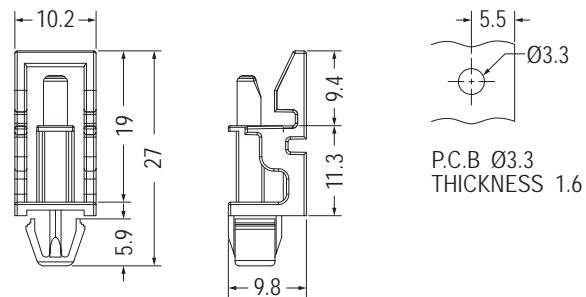

Part No.	Package
KEMS-11.3	500

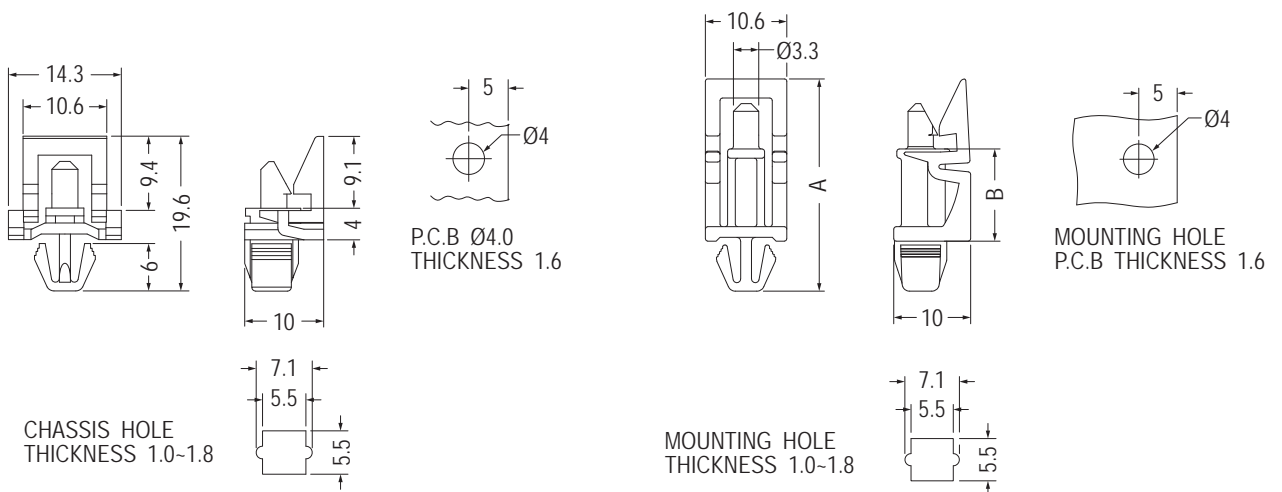
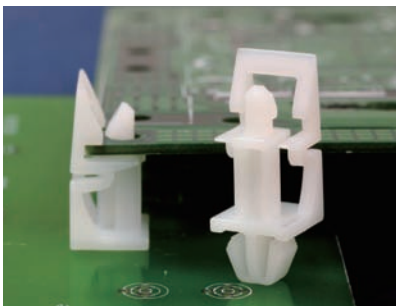

Part No.	Package
KEML-4	500

Part No.	A	B	Package
KEML-10	25.6	10.0	500
KEML-12	27.6	12.0	1000

PC板間隔柱 SPACER SUPPORT

用途：用於PC板與機板之固定。

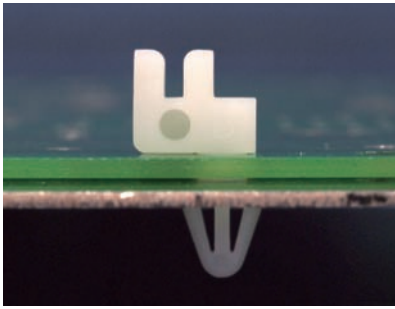

- Material: Nylon 66 (UL)
- Flame Class: 94V-2/94V-0
- Color: Natural/Black
- Unit: mm

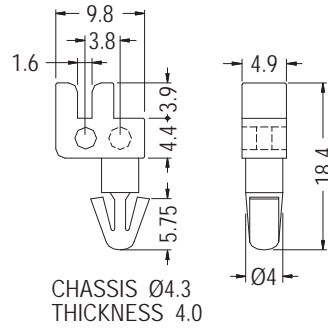

Part No.	Package
LCU-18	2000



- Material: Nylon 66 (UL)
- Flame Class: 94V-2/94V-0
- Color: Natural/Black
- Unit: mm

用途：背膠式，用於PC板端直接壓入固定。

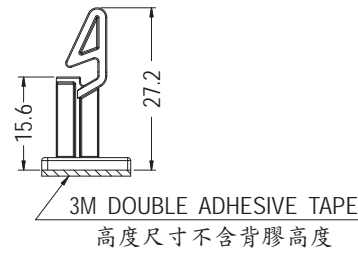
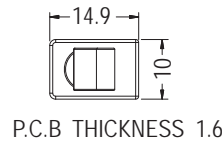

Part No.	Package
ULCKA-15.6	1000

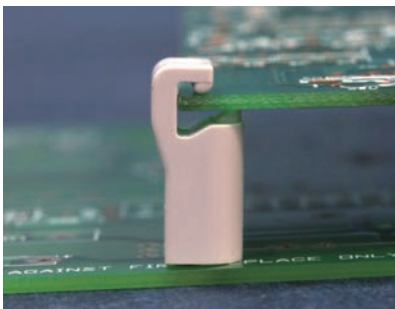

- Material: PC+ABS
- Color: Natural/Gray
- Unit: mm

用途：用於PCB固定及墊高，拆裝方便。

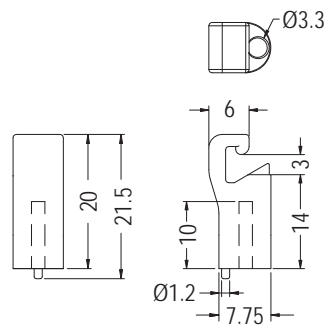

Part No.	Package
KESS-19	500

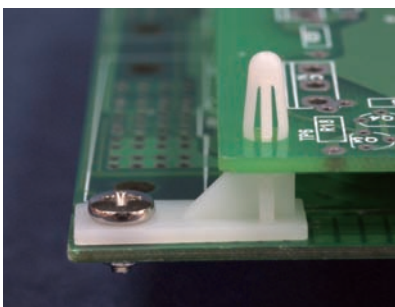

- Material: Nylon 66 (UL)
- Flame Class: 94V-2/94V-0
- Color: Natural/Black
- Unit: mm

用途：機板部分用螺絲固定，另一頭直接壓入PC板。

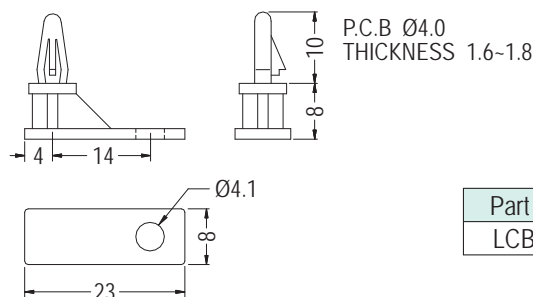

Part No.	Package
LCBL-8	1000

PC板間隔柱 SPACER SUPPORT

用途：用於PC板與機板之固定。

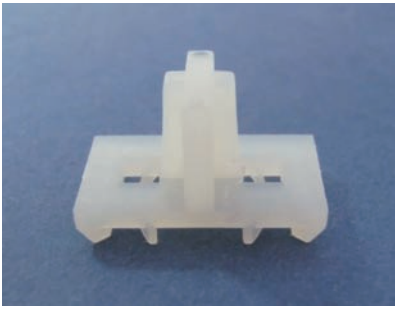

- Material: Nylon 66 (UL)
- Flame Class: 94V-2/94V-0
- Color: Natural/Black
- Unit: mm

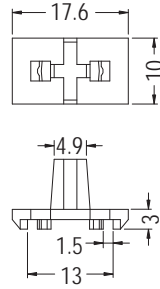

Part No.	Package
LIH-8	2000

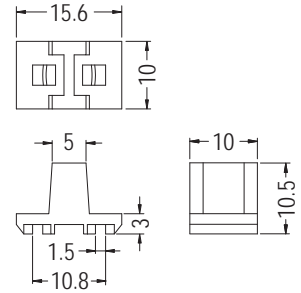

Part No.	Package
MOU-01	2000

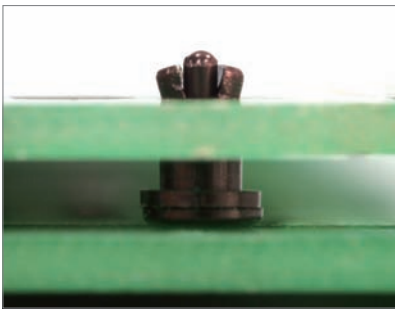

- Material: Nylon 66 (UL)
- Flame Class: 94V-2/94V-0
- Color: Natural/Black
- Unit: mm

用途：用於PC板與機板間墊高，省時方便。

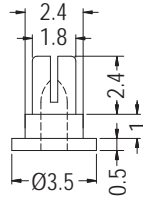

【SRMA-2A】

CHASSIS Ø1.8
THICKNESS 1.0-1.2

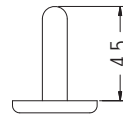

【SRMA-2B】

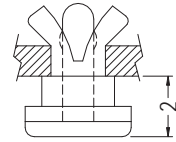

組裝示意圖

Part No.	組裝方式	Package
SRMA-2	不組裝	2000
SRMA-2F	SRMA-2A	
	SRMA-2B 組裝	

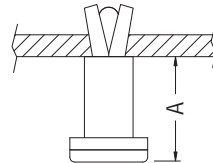
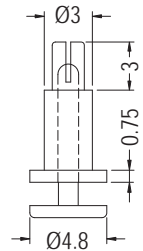
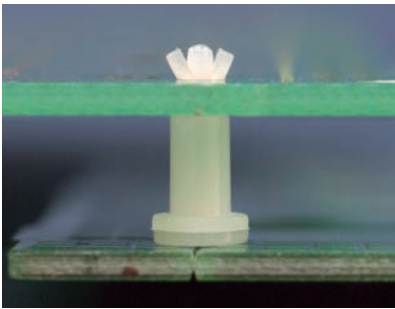

組裝示意圖

CHASSIS Ø2.0
THICKNESS 0.8-1.6

Part No.	A	Package
SRMA-3	3.0	2000
SRMA-3.5	3.5	
SRMA-4	4.0	
SRMA-5	5.0	
SRMA-6	6.5	
SRMA-9	9.0	

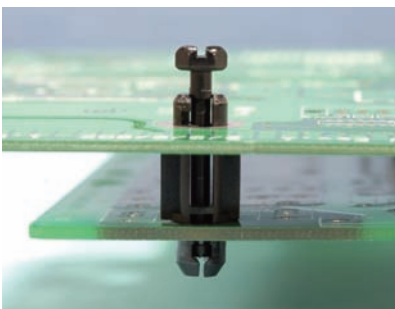

- Clip Material: PC (UL)/94V-2
- Pin Material: Nylon 66 (UL)/94V-2
- Color: Black
- Unit: mm

用途：用於PC板與機板間之固定易裝卸。

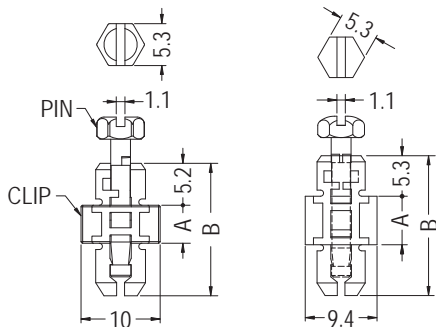

CHASSIS Ø6.3-Ø6.4
THICKNESS 1.4-2.4

【SCMB-4.8】

CHASSIS Ø6.4-Ø6.5
THICKNESS 0.8-1.6

Part No.	A	B	Package
SCMB-4.8	4.8	16.6	1000
SCMB-6.3	6.35	18.3	
SCMB-9.5	9.5	21.45	
SCMB-12.7	12.7	24.65	
SCMB-15.9	15.9	27.85	
SCMB-19.1	19.1	31.05	

間隔柱 SPACER

用途：用於零件之固定。



- Material: PC (UL)
- Flame Class: 94V-2
- Color: Natural/Black
- Unit: mm

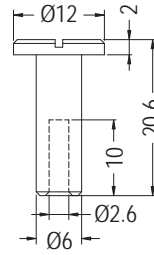

Part No.	Package
SMHC-1	1000

PC板間隔柱 SPACER SUPPORT

用途：PC板與PC板間之固定，不佔空間。

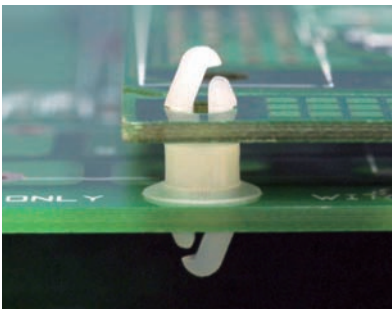

- Material: Nylon 66 (UL)/PC (UL)
- Flame Class: 94V-2/94V-0
- Color: Natural/Black
- Unit: mm

P.C.B Ø4.0
THICKNESS 1.6-1.9

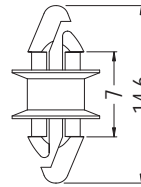

Part No.	Package
MSPR-3	1000

P.C.B Ø4.0
THICKNESS 1.6-1.9

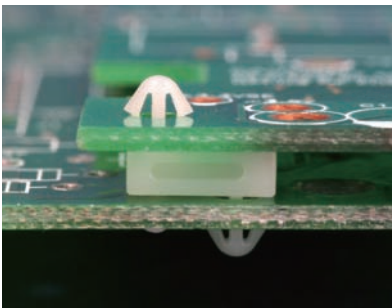

- Material: Nylon 66 (UL)
- Flame Class: 94V-2/94V-0
- Color: Natural/Black
- Unit: mm

用途：兩片PC板間隔之固定。

P.C.B Ø3.2
THICKNESS 1.6

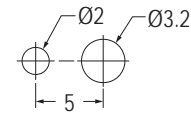
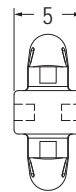
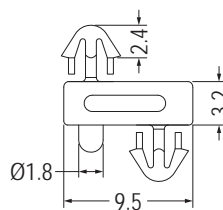

MOUNTING HOLE

P.C.B Ø3.2
THICKNESS 1.6

Part No.	Package
LUCE-1	1000

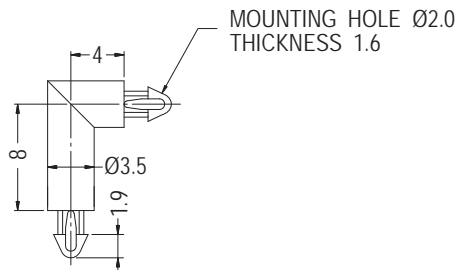
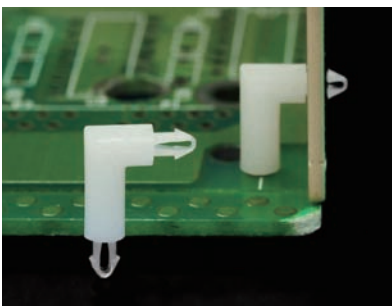

MOUNTING HOLE Ø2.0
THICKNESS 1.6

Part No.	Package
EM-682	2000

PC板固定座 PCB MOUNTING BLOCK

用途：用於PC板固定，使PC板與機板成90°固定。

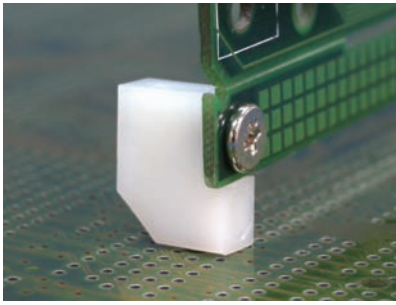

- Material: Nylon 66 (UL)
- Flame Class: 94V-2/94V-0
- Color: Natural/Black
- Unit: mm

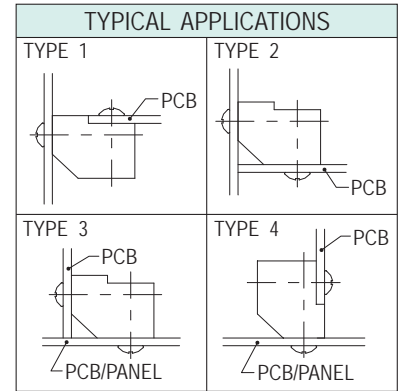
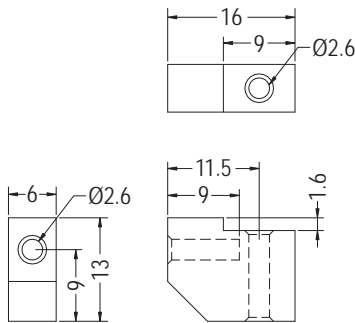

Part No.	Package
PMB-1	500

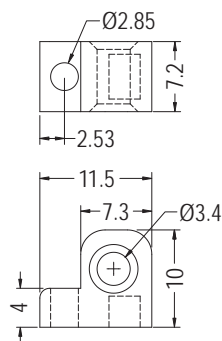

Part No.	Package
PMB-2	500

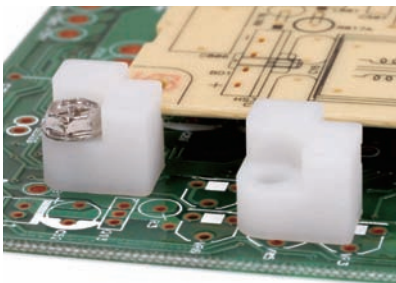

- Material: Nylon 66 (UL)
- Flame Class: 94V-2/94V-0
- Color: Natural/Black
- Unit: mm

用途：快速固定PC板於機板上。

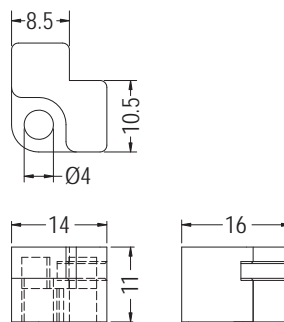

Part No.	Package
TCEA-1	1000



- Material: PC (UL)
- Flame Class: 94V-2/94V-0
- Color: Transparent
- Unit: mm

用途：配合螺絲，固定PC板於機板上。

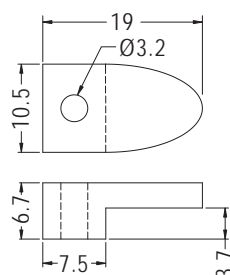

Part No.	Package
HW2839	1000

PC板固定扣 PCB HINGE

用途：一端固定於機板或PC板上，另一端固定於PC板上成90°。

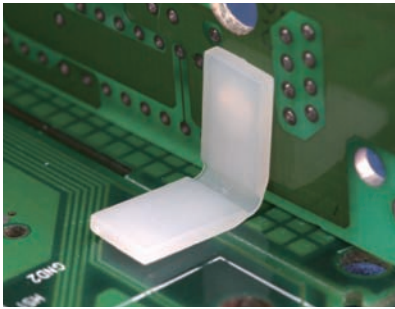

- Material: Nylon 66 (UL)
- Flame Class: 94V-2/94V-0
- Color: Natural/Black
- Unit: mm

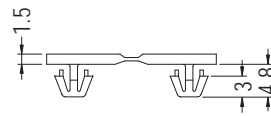

P.C.B Ø4.0
THICKNESS 1.6-1.8

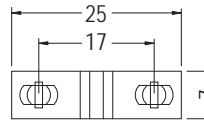

Part No.	Package
LPZ-1	1000

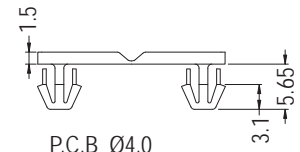

P.C.B Ø4.0
THICKNESS 2.36

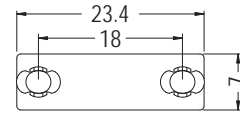

Part No.	Package
LPZ-9	1000

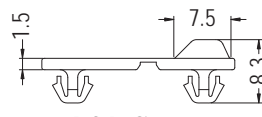
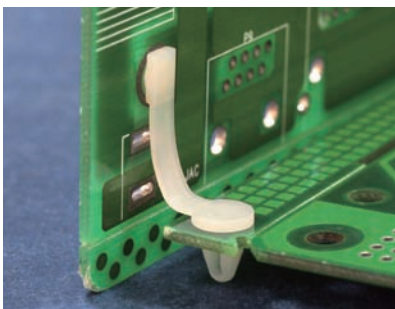

P.C.B Ø4.0
THICKNESS 1.6

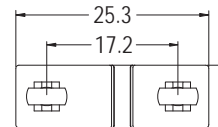

Part No.	Package
LPZ-6	1000

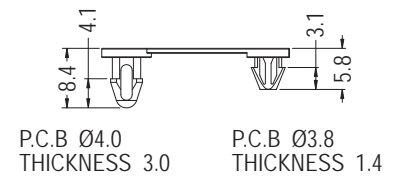

P.C.B Ø4.0
THICKNESS 3.0

P.C.B Ø3.8
THICKNESS 1.4

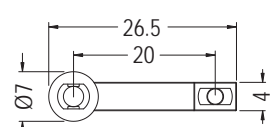

Part No.	Package
LPZ-2	1000

固定片 BRACKET

用途：快速固定PC板於機板上。

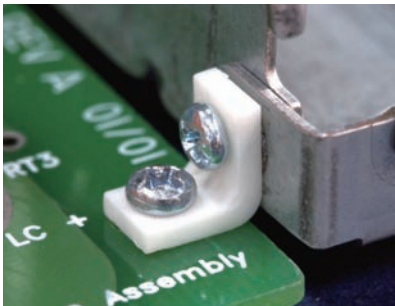

- Material: Nylon 66 (UL)
- Flame Class: 94V-2/94V-0
- Color: Natural/Black
- Unit: mm

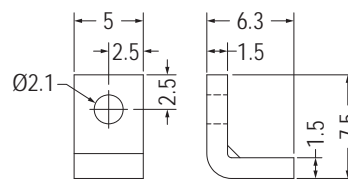
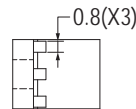

Part No.	Package
DELT-19	1000

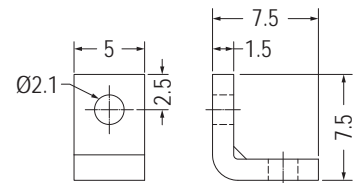
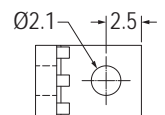

Part No.	Package
DELT-25	1000

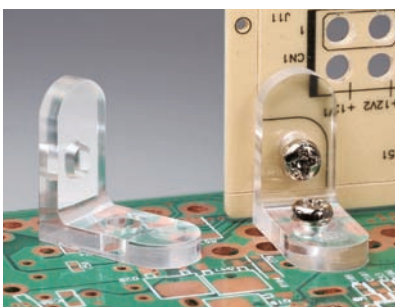

- Material: PC (UL)
- Flame Class: 94V-2
- Color: Transparent
- Unit: mm

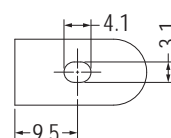
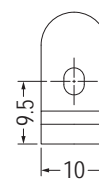
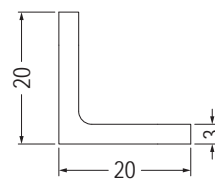

Part No.	Package
LPZA-1	1000

PC板間隔柱 SPACER SUPPORT

用途：用於散熱片之絕緣。

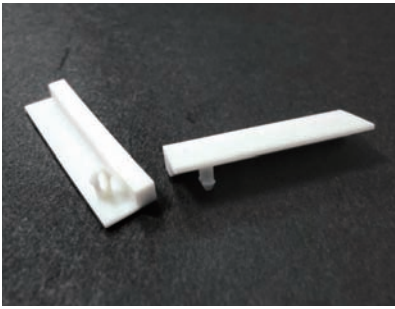

- Material: Nylon 66 (UL)
- Flame Class: 94V-2/94V-0
- Color: Natural/Black
- Unit: mm

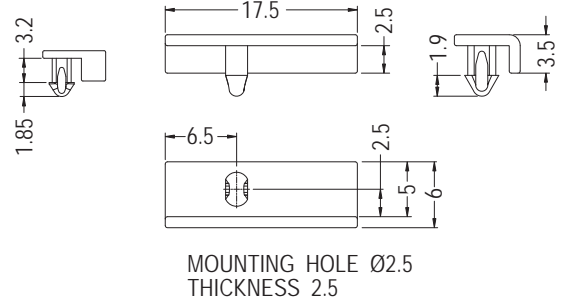
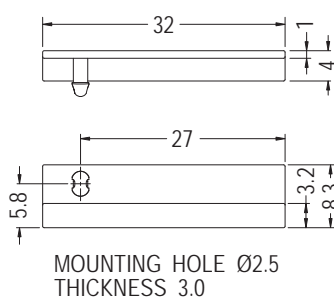

Part No.	Package
CGLF-32	1000

Part No.	Package
CGLE-18	1000



- Material: Nylon 66 (UL)
- Flame Class: 94V-2/94V-0
- Color: Natural/Black
- Unit: mm

用途：做為PC板與機板之絕緣。

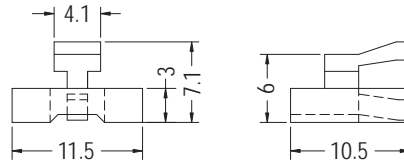

Part No.	Package
JYCE-1	1000

間隔柱 SPACER SUPPORT

用途：用於PC板與機板間之固定。

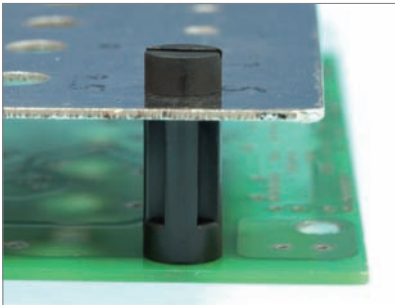

- Material: Nylon 66 (UL)
- Flame Class: 94V-2/94V-0
- Color: Natural/Black
- Unit: mm

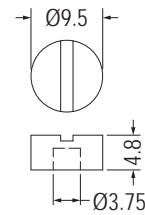
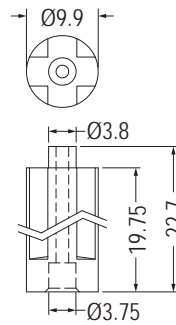

【 JYCE-2A 】

【 JYCE-2B 】

Part No.	Package
JYCE-2	500

圓體間隔柱 ROUND SPACER

用途：做為PC板與機板間之墊高與絕緣用。

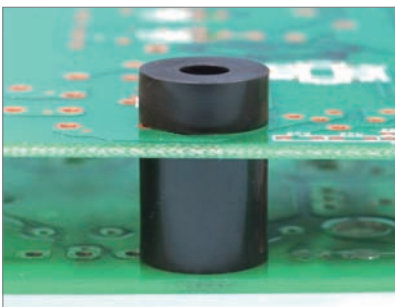

- Material: POM (UL)
- Flame Class: 94HB
- Color: Natural/Black
- Unit: mm

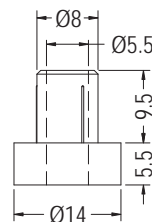
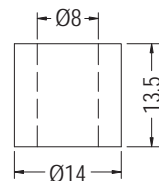

【 RXS-13.5 】

【 RXS-1 】

Part No.	Package
RXS-1	500
RXS-13.5	

圓體間隔柱 ROUND SPACER

1



- Material: POM (UL)
- Flame Class: 94HB
- Color: Black
- Unit: mm

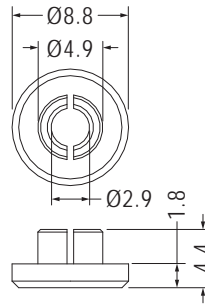

Part No.	Package
RSUA-1A	1000

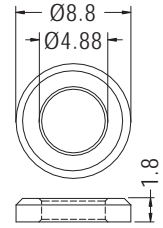

Part No.	Package
RSUA-1B	1000

用途：用於零件之絕緣使用，RSUA-1A與RSUA-1B需配合使用。

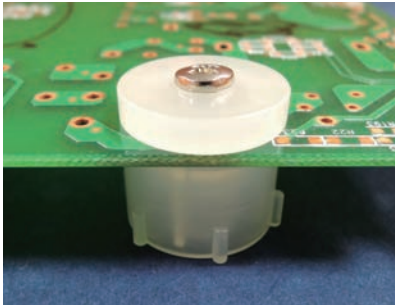

- Material: PC (UL)
- Flame Class: 94V-0
- Color: Natural
- Unit: mm

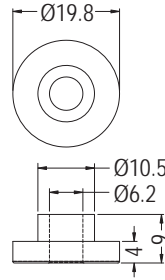

Part No.	Package
RLA-1	500

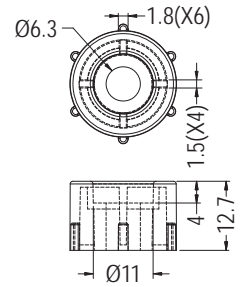

Part No.	Package
RLA-12.7	500

用途：做為PC板與機板間之墊高與固定。

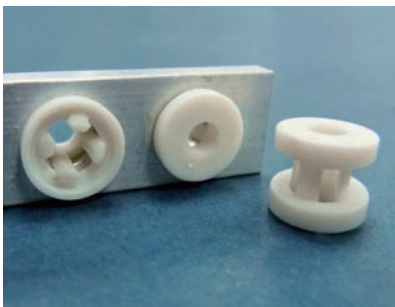

- Material: Nylon 66 (UL)
- Flame Class: 94V-2/94V-0
- Color: Natural/Black
- Unit: mm

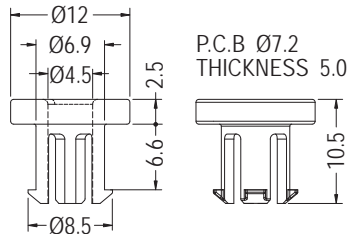

Part No.	Package
RML-1	1000

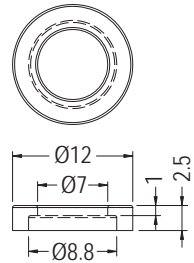

Part No.	Package
RML-25	1000

用途：用於PC板與機板間之墊高與絕緣。

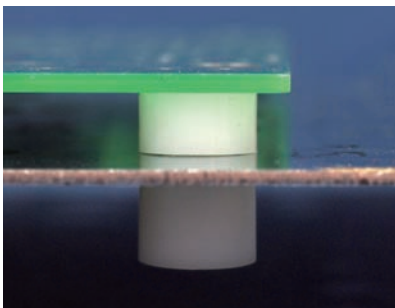

- Material: ABS (UL)
- Flame Class: 94HB
- Color: Natural
- Unit: mm

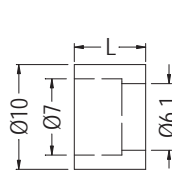

【RMM-】

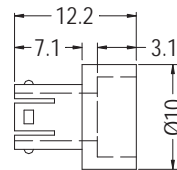

【RMM-1】

P.C.B Ø6.5
CHASSIS Ø4.0

Part No.	L	Package
RMM-1	RMM-75	7.5
	RMM-100	10.0
	RMM-150	15.0
		1000

- Material: Nylon 66 (UL)
- Flame Class: 94V-2/94V-0
- Color: Natural
- Unit: mm

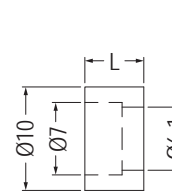

【RMM-】

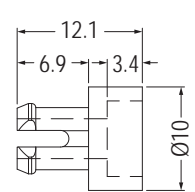

【RMM-3】

P.C.B Ø6.5
THICKNESS Ø2.4

Part No.	L	Package
RMM-3	RMM-57	5.7
	RMM-200	20.0
		1000

圓體間隔柱 ROUND SPACER

用途：用於PC板與機板間之墊高與絕緣。

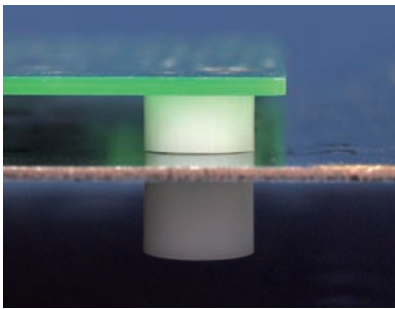

- Material: ABS (UL)
- Flame Class: 94HB
- Color: Natural
- Unit: mm

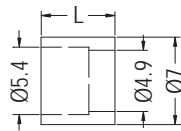

【 RSS- 】

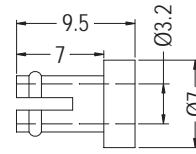

P.C.B Ø5.0
CHASSIS Ø3.5

【 RSS-1 】

- Material: Nylon 66 (UL)
- Flame Class: 94V-2/94V-0

Part No.	L	Package
RSS-60	6.0	1000
RSS-78	7.8	
RSS-105	10.5	
RSS-150	15.0	500
RSS-180	18.0	
RSS-200	20.0	
RSS-250	25.0	

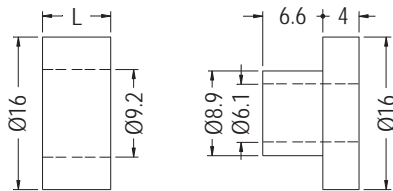

【 RXL- 】

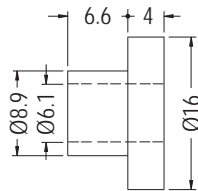

P.C.B Ø9.0
CHASSIS Ø6.0

【 RXL-1 】

Part No.	L	Package
RXL-5	5.0	500
RXL-7	7.5	
RXL-10	10.0	

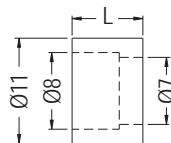

【 RLL- 】

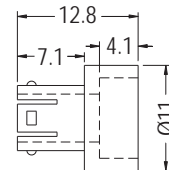

P.C.B Ø7.5
CHASSIS Ø4.5

【 RLL-1 】

Part No.	L	Package
RLL-57	5.7	1000
RLL-75	7.5	
RLL-100	10.3	500
RLL-150	15.0	1000
RLL-200	20.0	
RLL-254	25.4	

PC板間隔柱 SPACER SUPPORT

用途：做為PC板與機板之絕緣。

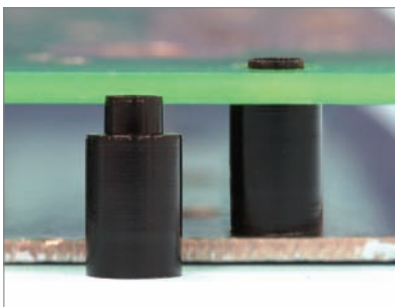

- Material: ABS (UL)
- Flame Class: 94HB
- Color: Natural/Black
- Unit: mm

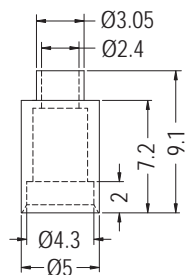

Part No.	Package
LASK-4	1000

- Material: POM
- Color: Black
- Unit: mm

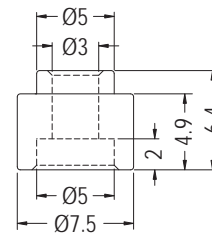

Part No.	Package
LASK-5	1000

- Material: N6T (UL)
- Flame Class: 94V-0
- Color: Black
- Unit: mm

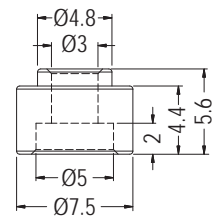

Part No.	Package
LASK-6	1000

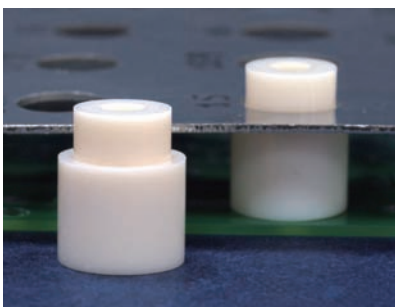

- Material: PC+ABS (UL)
- Flame Class: 94V-0
- Color: Natural
- Unit: mm

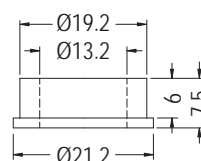

Part No.	Package
RCXL-1	1000

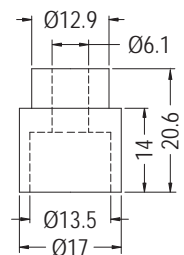

Part No.	Package
RCXL-14	1000

圓體間隔柱 ROUND SPACER

用途：做為板件與機板間之墊高與固定。

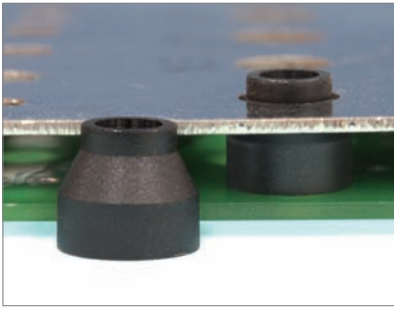

- Material: Nylon 66 (UL)
- Flame Class: 94V-2/94V-0
- Color: Natural/Black
- Unit: mm

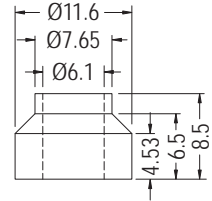
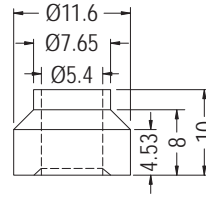

Part No.	Package
RC SL5-10	500

Part No.	Package
RC SL6-8.5	500

1



- Material: Nylon 6T (UL)
- Flame Class: 94V-0
- Color: Black
- Unit: mm

用途：做為螺絲或機板之絕緣用。

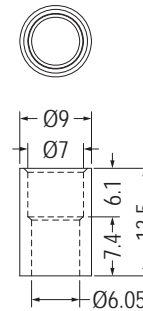

Part No.	Package
R7-13	1000

背膠式圓體間隔柱 ROUND SPACER WITH ADHESIVE TAPE

用途：背膠式，做為PC板之墊高。

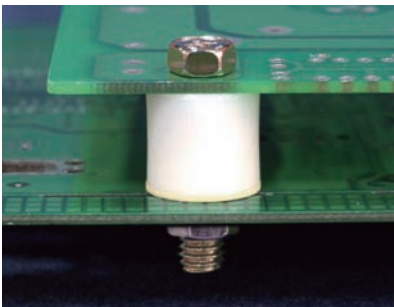

- Material: Nylon 66 (UL)
- Flame Class: 94V-2/94V-0
- Color: Natural/Black
- Unit: mm

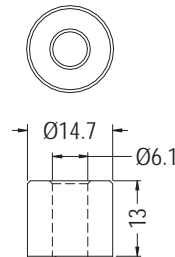

Part No.	Package
6-13A	1000

3M DOUBLE ADHESIVE TAPE

圓體間隔柱 ROUND SPACER

用途：做為PC板與機板之絕緣用。

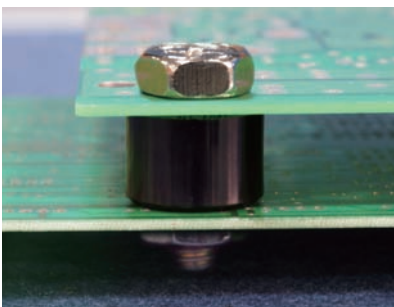

- Material: Nylon 66 (UL)
- Flame Class: 94V-2/94V-0
- Color: Natural/Black
- Unit: mm

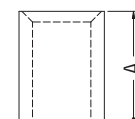
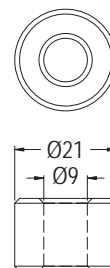

Part No.	Package
9-15	1000

Part No.	A	B	C	Package
KE3.5-2	2.0	3.5	6.3	2000
KE4.1-8	8.0	4.1	6.0	1000

圓體間隔柱 ROUND SPACER

用途：做為PC板與機板之絕緣用。



- Material: Nylon 66 (UL)
- Flame Class: 94V-2
- Color: Red
- Unit: mm

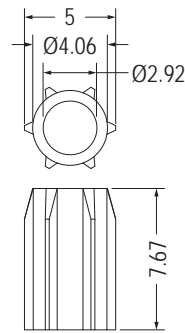

Part No.	Package
EM-733	2000

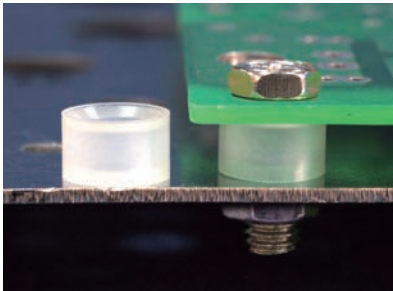

- Material: PC (UL)
- Flame Class: 94V-2/94V-0
- Color: Natural
- Unit: mm

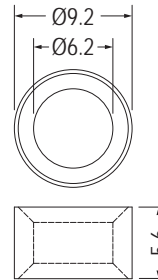

Part No.	Package
DELTA-3	1000

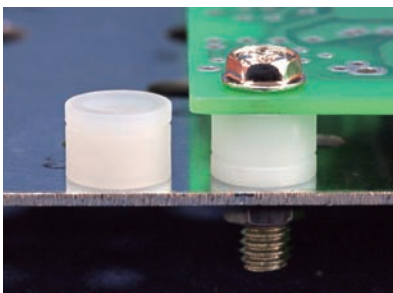

- Material: Nylon 66 (UL)
- Flame Class: 94V-2/94V-0
- Color: Natural/Black
- Unit: mm

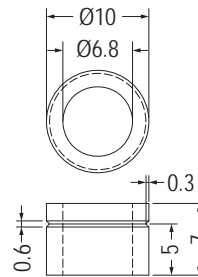

Part No.	Package
RR-1	1000

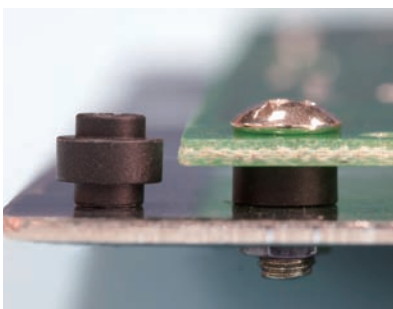

- Material: Nylon 6T (UL)
- Flame Class: 94V-0
- Color: Black
- Unit: mm

MOUNTING HOLE Ø4.5

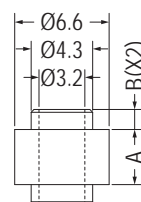

Part No.	A	B	Package
LUS-2.7	2.7	1.5	1000
LUS-2.9	2.9	0.7	
LUS-3	3.0	0.7	
LUS-3.85	3.85	1.4	

MOUNTING HOLE Ø4.5

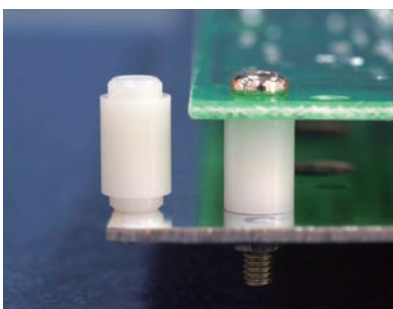

- Material: ABS (UL)
- Flame Class: 94HB
- Color: Natural
- Unit: mm

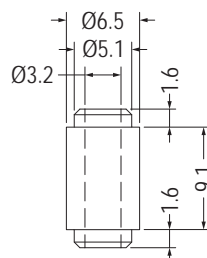

Part No.	Package
LUS-9.1	1000

- Material: Nylon 66 (UL)
- Flame Class: 94V-2/94V-0
- Color: Natural/Black
- Unit: mm

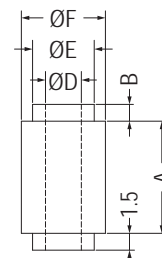

Part No.	A	B	D	E	F	Package
LUS-10	10.0	1.5	3.2	5.5	7.5	1000
LUS-74.5	74.5	1.0	6.5	8.0	10.0	500

圓體間隔柱 ROUND SPACER

用途：用於PC板與機板之絕緣。

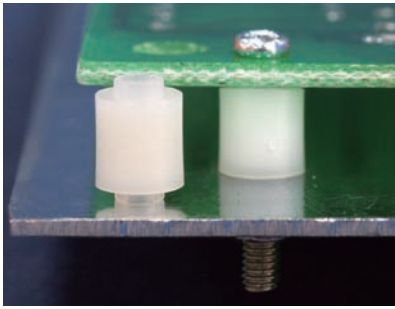

- Material: Nylon 66 (UL)
- Flame Class: 94V-2/94V-0
- Color: Natural/Black
- Unit: mm

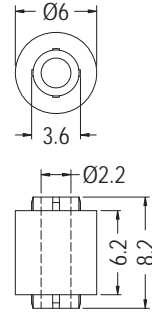

Part No.	Package
LUS2-8.2	1000

MOUNTING HOLE Ø3.5

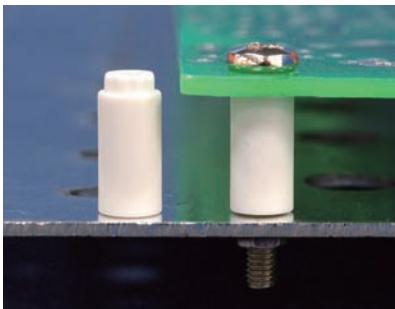

- Material: PBT (UL)
- Flame Class: 94V-0
- Color: Natural/Black
- Unit: mm

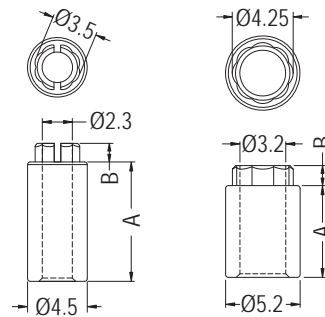

【 LUSS-6.2, LUSS-9 】

Part No.	A	B	Package
LUSS-6.2	6.2	1.0	1000
LUSS-6.4	6.4	1.4	
LUSS-7.1	7.07	1.4	
LUSS-9	9.0	1.4	
LUSS-9.4	9.43	1.4	
LUSS-10.1	10.06	1.4	

PC板間隔柱 SPACER SUPPORT

用途：PC板與PC板間之固定，不佔空間。

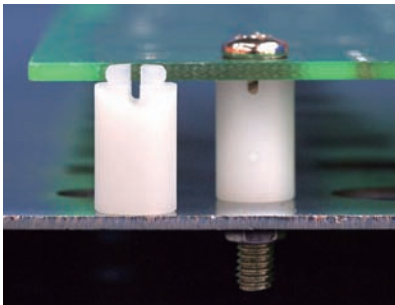

- Material: Nylon 66 (UL)
- Flame Class: 94V-2/94V-0
- Color: Natural/Black
- Unit: mm

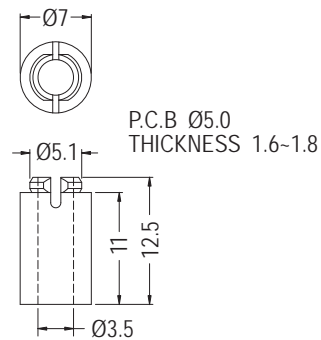

Part No.	Package
LUSA-11	1000

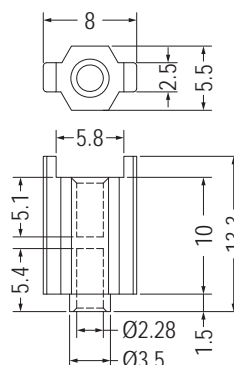
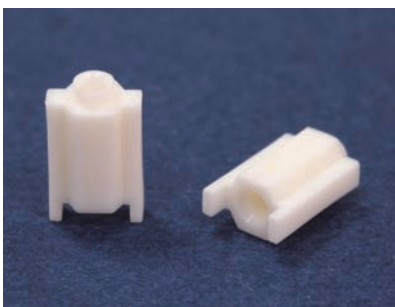

Part No.	Package
LUSB-10	1000

圓體間隔柱 ROUND SPACER

用途：做為PC板之墊高，尺寸齊全。

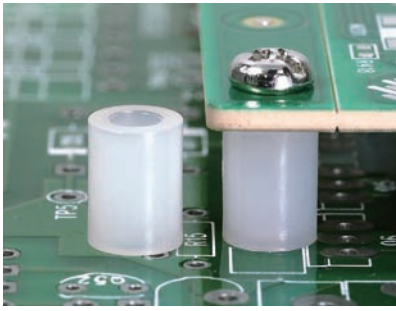

- Material: Nylon 66 (UL)/POM/TPE/PE/
PC (UL)/ABS (UL)/PPS
- Flame Class: 94HB/94V-2/94V-0
- Color: Natural/Black
- Unit: mm

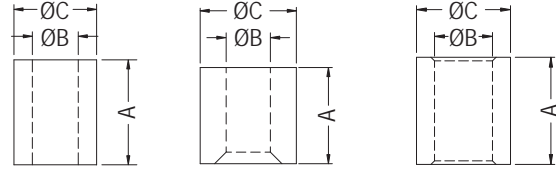

【 2.3-5, 2.3-5.5 】 【 4.9-4.5, 4.9-11.5, 4.9-13 】

Part No.	A(L)	B(ID)	C(OD)	Package	
0.7-1.6	1.6	0.7	2.0	1000	
0.7-3	3.0	0.71	2.2		
1.2-2.5	2.5	1.2	4.0		
1.2-3	3.0	1.2	3.2		
1.2-5	5.0	1.2	4.0	2000	
1.2-6.35	6.35	1.2	3.2		
1.2-7.6	7.6	1.2	4.0	1000	
1.4-3	3.0	1.4	3.5		
1.6-2	2.0	1.6	4.0		
1.6-4	4.0	1.6	4.0		
1.6-5.9	5.89	1.63	3.18	2000	
1.7-11.3	11.3	1.7	3.0	1000	
2-3-1.9	1.9	2.02	3.0	2000	
2.05-3.5	3.5	2.05	3.0	1000	
2.1-2.1	2.1	2.1	2.4		
2.2-2.5	1.5	2.2	2.5	2000	
2.2-5	5.0	2.2	4.0	1000	
2.3-5	5.0	2.3	5.0		
2.3-5.5	5.5	2.3	5.0		
2.4-9.4	9.4	2.4	4.8		
2.5-2.15	2.15	2.5	4.0		
2.5-1655	16.0	2.5	5.5		
2.7-2.8	2.84	2.7	6.35		
2.7-6.7	6.71	2.7	6.35		
2.73-2.3	2.3	2.73	4.3		
2.8-3.8	3.8	2.8	4.3		
2.95-8	8.0	2.95	3.55		
3-25-6	25.0	3.0	6.0		
3.1-2	2.0	3.1	6.0		2000
3.1-2.2	2.2	3.1	8.0		
3.1-3.5	3.5	3.1	5.7		
★3.1-3.7	3.7	3.15	5.0		
3.1-4-6	4.0	3.1	6.0	1000	
3.1-5	5.0	3.1	6.0		
3.1-6	6.0	3.1	6.0		
★6-3.1-7.5	7.5	3.1	6.0		
3.1-7.5	7.5	3.1	8.0	2000	
3.1-8	8.0	3.1	6.0	1000	
3.1-3.8	3.85	3.15	5.0		
3.1-4	4.0	3.15	5.0	2000	
3.2-2.2	2.2	3.2	5.5	2000	
3.2-2.5	2.5	3.2	4.2	1000	
3.2-3	3.0	3.2	5.8		
3.2-4.45	4.45	3.2	6.4		
3-5.8	5.85	3.2	5.0		
3.2-6.4	6.4	3.2	5.8		
6432-6.4	6.4	3.2	6.4		
3.2-6.8	6.8	3.2	4.5		
3.2-10	10.0	3.2	8.0		
3.35-5	5.0	3.35	8.0		
3.5-5.5	5.5	3.5	6.3		
3.55-10	10.0	3.55	6.0		

Part No.	A(L)	B(ID)	C(OD)	Package	
3.55-31.8	31.8	3.55	6.35	1000	
3.56-4.76	4.76	3.56	7.94		
3.56-9.53	9.53	3.56	6.35		
3.6-2	2.0	3.6	7.0		
3.6-19	19.0	3.6	8.0	2000	
3.7-6.1	6.1	3.7	6.4		
3.7-9.5	9.5	3.73	6.35	1000	
3.7-10	10.0	3.73	6.35		
3.8-0.5	0.5	3.8	5.3	2000	
3.8-5.5	5.5	3.8	5.3	1000	
3.9-5.3	5.3	3.9	8.0		
3.95-3.8	3.8	3.95	6.1		
4-4.8	4.8	4.0	7.5		
4.1-2.5	2.5	4.1	8.0	1000	
4.2-2.4	2.4	4.2	7.5	2000	
4.2-4.8	4.8	4.2	5.5		
4.2-8.5	8.5	4.2	10.0	1000	
4.3-1.5	1.5	4.3	5.8	2000	
4.3-5.5	5.5	4.3	5.8		
4.3-10.5	10.5	4.3	5.8	1000	
4.3-15.5	15.5	4.3	5.8		
4.4-6	6.0	4.4	7.43	2000	
4.4-6.4	6.4	4.4	9.5		
4.5-3.2	3.18	4.45	6.35	1000	
4.5-2.75	2.75	4.5	6.0		
4.5-11	11.0	4.5	7.0		
4.5-11.5	11.5	4.5	7.0		
4.5-19.9	19.9	4.5	6.1	250	
4.7-3.5	3.5	4.7	6.0	1000	
4.9-3	3.0	4.9	7.94		
4.9-4.5	4.5	4.9	7.94		
4.9-11.5	11.5	4.9	7.94		
4.9-13	13.0	4.9	7.94	2000	
5-3.5	3.5	5.0	9.0		
5-4	4.0	5.0	12.0		
5-4.2	4.2	5.0	7.0		
5-6.5L	6.5	5.0	9.5	1000	
5-7.9L	7.9	5.0	9.5		
5-38.1	38.1	5.0	7.9	500	
5-40	40.0	5.0	9.0	1000	
5.1-12.7	12.7	5.1	9.5		
5.2-2	2.0	5.2	6.8		
5.2-2.3	2.3	5.2	6.8		
5.2-3	3.0	5.2	6.8		
5.2-4.1	4.1	5.2	6.8		
5.2-6	6.0	5.2	10.0		
5.2-7.5	7.5	5.2	7.6		
5.2-11	11.0	5.2	7.6		
5.2-13	13.0	5.2	6.8		
★5.3-2.8	2.8	5.3	8.5		2000
5.4-122	122.0	5.4	9.53		250
5.5-4	4.0	5.5	15.0		1000

圓體間隔柱 ROUND SPACER

用途：做為PC板之墊高，尺寸齊全。

1

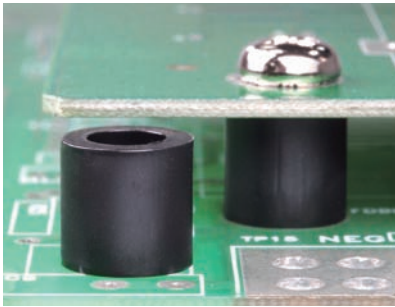

- Material: Nylon 66 (UL)/POM/TPE/PE/PC (UL)/ABS (UL)/PPS
- Flame Class: 94HB/94V-2/94V-0
- Color: Natural/Black
- Unit: mm

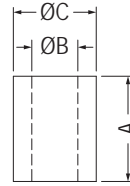

Part No.	A(L)	B(ID)	C(OD)	Package	
5.55-11.8	11.8	5.55	7.0	1000	
5-5	5.0	5.6	8.6		
5-6	6.0	5.6	8.6		
5-7.9	7.9	5.6	8.6		
5-8	8.0	5.6	8.6		
5-8.8	8.8	5.6	8.6		
5-11.8	11.8	5.6	8.6		
5-14	14.0	5.6	8.6		
5-16.5	16.5	5.6	8.6		
5-16.7	16.7	5.6	8.6		
5-17	17.0	5.6	8.6		
5-20	20.0	5.6	8.6		250
5.7-12.9	12.9	5.7	7.7		1000
5.7-14.1	14.1	5.7	7.7		
5.8-4.9	4.9	5.8	7.3		2000
5.8-14.4	14.4	5.8	7.3		
6-6	6.0	6.0	10.0		250
6-22	22.0	6.0	15.0		
6.2-6S	6.0	6.2	10.0	1000	
★6.2-10	10.0	6.2	10.4		
6.2-12	12.0	6.2	10.4		
6.3-5	5.0	6.3	15.0	250	
6.3-20	20.0	6.3	12.7		
★6.35-3.2	3.2	6.35	9.1	1000	
6.35-7.1	7.1	6.35	8.0		
6.4-3	3.0	6.4	12.0		
6.4-10	10.0	6.4	20.0	500	
6.5-3	3.0	6.5	9.2	1000	
6-4.2	4.2	6.6	10.6		

Part No.	A(L)	B(ID)	C(OD)	Package	
6-4.8	4.8	6.6	9.1	1000	
6-16	15.7	6.6	9.1		
6.8-5	5.0	6.8	10.0		
6.9-12.7	12.7	6.9	12.7		
7-5.5	5.5	7.0	13.0		
7-8.7	8.7	7.0	10.0		
7.5-8.9	8.9	7.5	10.0		250
7.5-29	29.0	7.5	11.0		
8-16	15.7	8.1	10.7		1000
8.2-5.5	5.5	8.2	12.0		
★8.2-80	80.0	8.2	10.0		250
8.4-5	5.0	8.4	16.0		1000
8.5-4.6	4.6	8.5	10.3		
8.5-612	6.0	8.5	12.0		
8.5-8	7.9	8.5	11.0		
★9-2.5	2.5	9.0	15.0		
★9-4	4.0	9.0	15.0		
★9-10.5	10.5	9.0	15.0	250	
9.1-7.5	7.5	9.1	17.9		
9.25-4	4.0	9.25	12.25		
9.5-34	34.0	9.5	19.0		
10-6	6.0	10.0	12.0		
1012-26	26.0	10.0	12.0	1000	
12-19	19.0	12.0	14.0		
12.4-5	5.0	12.4	22.0	250	
12.8-35	35.0	12.8	22.0		
13-5	5.0	13.0	24.0		
20.5-9.5	9.5	20.5	25.5	1000	
29-16	16.0	29.5	33.5		

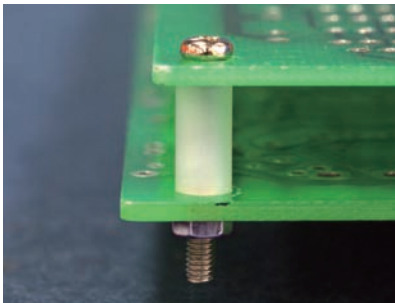

- Material: Nylon 66 (UL)/PBT (UL)
- Flame Class: 94V-2/94V-0
- Color: Natural/Black
- Unit: mm

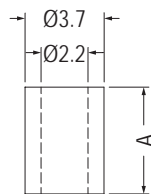

Part No.	A(L)	Package
2-1.8	1.8	2000
2-2	2.0	
2-2.5	2.5	
2-3	3.0	
2-3.2	3.2	
2-4	4.0	
2-4.3	4.3	
2-5	5.0	
2-5.3	5.3	
2-6	6.0	
2-7	7.0	

Part No.	A(L)	Package
2-8	8.0	2000
2-9	9.0	
2-9.5	9.5	
2-10	10.0	
2-11	11.0	
2-12	12.0	
2-13	13.0	
2-14	14.0	
2-15	15.0	
2-16	16.0	

圓體間隔柱 ROUND SPACER

用途：做為PC板之墊高，尺寸齊全。

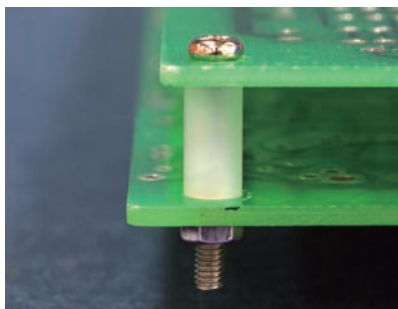

- Material: Nylon 66 (UL)/PBT (UL)
- Flame Class: 94V-2/94V-0
- Color: Natural/Black
- Unit: mm

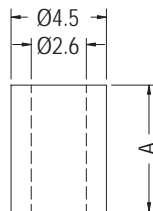

Part No.	A(L)	Package
2.6-2	2.0	2000
2.6-3	3.0	
2.6-4	4.0	
2.6-5	5.0	
2.6-6	6.0	
2.6-7	7.0	
2.6-8	8.0	
2.6-9	9.0	
2.6-10	10.0	
2.6-11	11.0	
2.6-12	12.0	
2.6-13	13.0	
2.6-14	14.0	
2.6-15	15.0	
2.6-16	16.0	

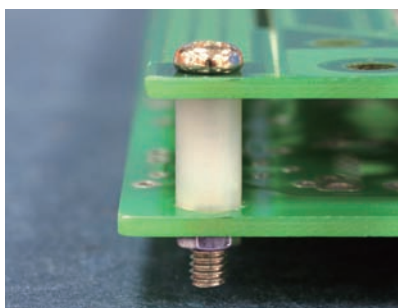

- Material: Nylon 66 (UL)
- Flame Class: 94V-2/94V-0
- Color: Natural/Black
- Unit: mm

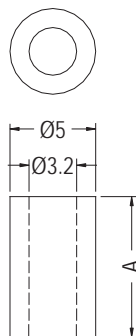

Part No.	A(L)	Package
3-1.5	1.5	2000
3-2	2.0	
3-2.5	2.5	
3-3	3.0	
3-3.3	3.3	
3-3.5	3.5	
3-4	4.0	
3-4.2	4.2	
3-4.5	4.5	
3-5	5.0	
3-5.1	5.05	
3-5.5	5.5	
3-6	6.0	
3-6.35	6.35	
3-7	7.0	
3-7.5	7.5	
3-8	8.0	
3-9	9.0	
3-9.5	9.5	
3-10	10.0	
3-10.5	10.5	
3-11	11.0	
3-12	12.0	

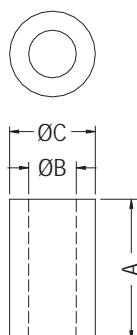

Part No.	A(L)	B(ID)	C(OD)	Package
3-20L	20.0	3.2	6.0	1000
3-38.1	38.1	3.05	6.35	

Part No.	A(L)	Package
3-13	13.0	1000
3-13.6	13.6	
3-14	14.0	
3-15	15.0	
3-15.5	15.5	
3-16	16.0	
3-16.5	16.5	
3-16.8	16.8	
3-17	17.0	
3-17.5	17.5	
3-18	18.0	
3-19	19.0	
3-20	20.0	
3-21	21.0	
3-22	22.0	
3-23	23.0	
3-24	24.0	
3-25	25.0	
3-26	26.0	
3-27	27.0	
3-28	28.0	
3-29	29.0	
3-30	30.0	
3-35	35.0	

用途：做為PC板之墊高，尺寸齊全。

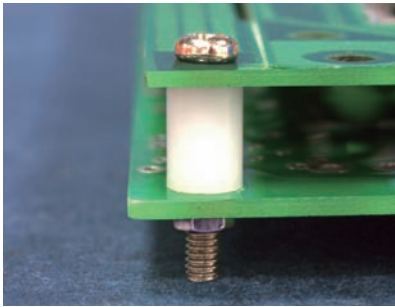

- Material: Nylon 66 (UL)
- Flame Class: 94V-2/94V-0
- Color: Natural/Black
- Unit: mm

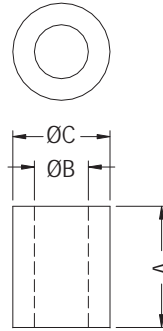

Part No.	A(L)	B(ID)	C(OD)	Package
3.5-1.6	1.6	3.5	6.3	2000
3.5-2	2.0	3.5	6.3	
3.5-3	3.0	3.5	6.3	
3.5-3.5	3.5	3.5	6.3	
3.5-4	4.0	3.5	6.3	
3.5-4.5	4.5	3.5	6.3	
3.5-5	5.0	3.5	6.3	
3.5-6	6.0	3.5	6.3	
3.5-6.4	6.4	3.5	6.3	
3.5-7	7.0	3.5	6.3	
3.5-7.5	7.5	3.5	6.3	
3.5-8	8.0	3.5	6.3	
3.5-9	9.0	3.5	6.3	
3.5-9.5	9.5	3.5	6.3	
3.5-10	10.0	3.5	6.3	
3.5-11	11.0	3.5	6.3	
3.5-12	12.0	3.5	6.3	
3.5-12.7	12.7	3.5	6.3	
3.5-13	13.0	3.5	6.3	
3.5-14	14.0	3.5	6.3	
3.5-15	15.0	3.5	6.3	
3.5-15.5	15.5	3.5	6.3	
3.5-16	16.0	3.5	6.3	
3.5-17	17.0	3.5	6.3	
3.5-17.7	17.7	3.5	6.3	
3.5-18	18.0	3.5	6.3	
3.5-19	19.0	3.5	6.3	
3.5-20	20.0	3.5	6.3	
3.5-21	21.0	3.7	6.3	
3.5-22	22.0	3.7	6.3	
3.5-23	23.0	3.7	6.3	
3.5-24	24.0	3.7	6.3	
3.5-25	25.0	3.7	6.3	
3.5-26	26.0	3.7	6.3	
3.5-27	27.0	3.7	6.3	
3.5-28	28.0	3.7	6.3	
3.5-28.5	28.57	3.55	6.35	
3.5-29	29.0	3.7	6.3	
3.5-30	30.0	3.7	6.3	
3.5-35	35.0	3.7	6.3	

Part No.	A(L)	B(ID)	C(OD)	Package
4-2	2.0	4.2	6.3	2000
4-3	3.0	4.2	6.3	
4-3.4	3.4	4.2	6.3	
4-3.5	3.5	4.2	6.3	
4-4	4.0	4.2	6.3	
4-4.83	4.83	4.2	6.3	
4-5	5.0	4.2	6.3	
4-6	6.0	4.2	6.3	
4-7	7.0	4.2	6.3	
4-7.5	7.5	4.2	6.3	
4-8	8.0	4.2	6.3	
4-8.5	8.5	4.2	6.3	
4-9	9.0	4.2	6.3	
4-9.5	9.5	4.2	6.3	
4-10	10.0	4.2	6.3	
4-11	11.0	4.2	6.3	
4-12	12.0	4.2	6.3	
4-12.7	12.7	4.2	6.3	
4-13	13.0	4.2	6.3	
4-14	14.0	4.2	6.3	
4-15	15.0	4.2	6.3	
4-16	16.0	4.2	6.3	
4-17	17.0	4.2	6.3	
4-18	18.0	4.2	6.3	
4-19	19.0	4.2	6.3	
4-20	20.0	4.2	6.3	
4-21	21.0	4.2	6.3	
4-22	22.0	4.2	6.3	
4-23	23.0	4.2	6.3	
4-24	24.0	4.2	6.3	
4-25	25.0	4.2	6.3	
4-26	26.0	4.2	6.3	
4-27	27.0	4.2	6.3	
4-28	28.0	4.2	6.3	
4-28.7	28.7	4.2	6.3	
4-29	29.0	4.2	6.3	
4-30	30.0	4.2	6.3	
4-40	40.0	4.2	6.3	
4-45	45.0	4.2	6.3	

間隔柱 SPACER SUPPORT

用途：做為PC板與PC板或機板間之固定
不掉落。

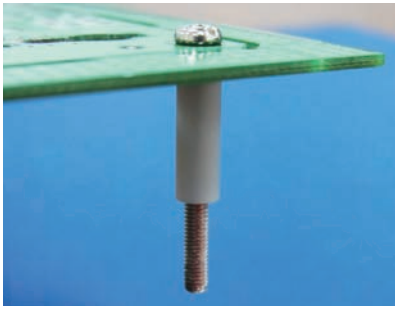

- Material: Nylon 66 (UL)
- Flame Class: 94V-2/94V-0
- Color: Natural/Black
- Unit: mm

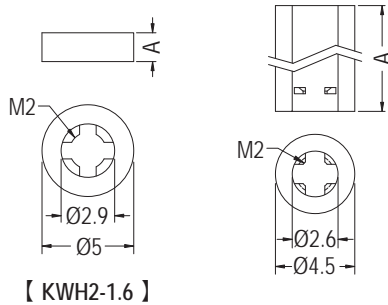

Part No.	A	Package
KWH2-1.6	1.57	2000
KWH2-2	2.0	
KWH2-3	3.0	
KWH2-3.5	3.5	
KWH2-4	4.0	
KWH2-5	5.0	
KWH2-6	6.0	
KWH2-6.3	6.3	
KWH2-7	7.0	
KWH2-8	8.0	
KWH2-9	9.0	
KWH2-9.5	9.5	
KWH2-10	10.0	
KWH2-11	11.0	
KWH2-11.5	11.5	
KWH2-12	12.0	
KWH2-12.7	12.7	
KWH2-13	13.0	
KWH2-14	14.0	

Part No.	A	Package
KWH2-15	15.0	2000
KWH2-15.9	15.9	
KWH2-16	16.0	
KWH2-17	17.0	
KWH2-18	18.0	
KWH2-19	19.0	
KWH2-20	20.0	1000
KWH2-21	21.0	
KWH2-22	22.0	
KWH2-23	23.0	
KWH2-24	24.0	
KWH2-25	25.0	
KWH2-25.4	25.4	
KWH2-26	26.0	
KWH2-27	27.0	
KWH2-28	28.0	
KWH2-29	29.0	
KWH2-30	30.0	

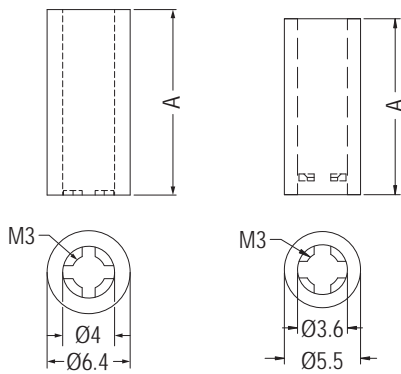

Part No.	A	Package
KWH3-1.5	1.5	2000
KWH3-2	2.0	
KWH3-3	3.0	
KWH3-3.2L	3.2	
KWH3-3.5	3.5	
KWH3-4	4.0	
KWH3-5	5.0	
KWH3-6	6.0	
KWH3-6.3	6.3	
KWH3-7	7.0	
KWH3-8	8.0	
KWH3-9	9.0	
KWH3-9.5	9.5	
KWH3-10	10.0	
KWH3-11	11.0	
KWH3-11.5	11.5	
KWH3-12	12.0	
KWH3-12.7	12.7	
KWH3-13	13.0	

Part No.	A	Package
KWH3-14	14.0	1000
KWH3-14.3L	14.3	
KWH3-15	15.0	
KWH3-15.9	15.9	
KWH3-16	16.0	
KWH3-17	17.0	
KWH3-18	18.0	
KWH3-19	19.0	
KWH3-20	20.0	
KWH3-21	21.0	
KWH3-22	22.0	
KWH3-23	23.0	
KWH3-24	24.0	
KWH3-25	25.0	
KWH3-25.4	25.4	
KWH3-26	26.0	
KWH3-27	27.0	
KWH3-28	28.0	
KWH3-29	29.0	
KWH3-30	30.0	

間隔柱 SPACER SUPPORT

用途：做為PC板與PC板或機板間之固定不掉落。

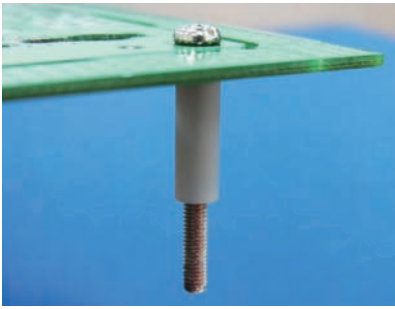

- Material: Nylon 66 (UL)
- Flame Class: 94V-2/94V-0
- Color: Natural/Black
- Unit: mm

1

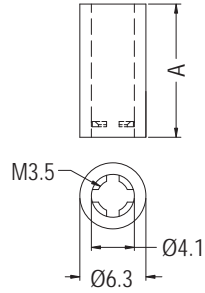

Part No.	A	Package
KWH3.5-2	2.0	2000
KWH3.5-3	3.0	
KWH3.5-4	4.0	
KWH3.5-5	5.0	
KWH3.5-6	6.0	
KWH3.5-6.3	6.3	
KWH3.5-7	7.0	
KWH3.5-8	8.0	
KWH3.5-9	9.0	
KWH3.5-10	10.0	
KWH3.5-11	11.0	
KWH3.5-12	12.0	
KWH3.5-12.7	12.7	
KWH3.5-13	13.0	
KWH3.5-14	14.0	
KWH3.5-15	15.0	
KWH3.5-15.9	15.9	

Part No.	A	Package
KWH3.5-16	16.0	2000
KWH3.5-17	17.0	
KWH3.5-18	18.0	
KWH3.5-19	19.0	
KWH3.5-20	20.0	
KWH3.5-21	21.0	
KWH3.5-22	22.0	1000
KWH3.5-23	23.0	
KWH3.5-24	24.0	
KWH3.5-25	25.0	
KWH3.5-25.4	25.4	
KWH3.5-26	26.0	
KWH3.5-27	27.0	
KWH3.5-28	28.0	
KWH3.5-29	29.0	
KWH3.5-30	30.0	

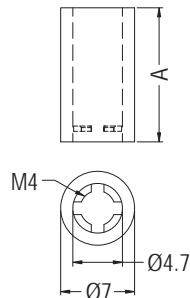
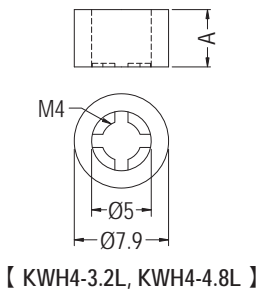

Part No.	A	Package
KWH4-2	2.0	2000
KWH4-3	3.0	
KWH4-3.2L	3.2	
KWH4-4	4.0	
KWH4-4.8L	4.8	
KWH4-5	5.0	
KWH4-6	6.0	
KWH4-6.3	6.3	
KWH4-7	7.0	
KWH4-8	8.0	
KWH4-9	9.0	
KWH4-9.5L	9.5	
KWH4-10	10.0	
KWH4-11	11.0	
KWH4-12	12.0	
KWH4-12.7	12.7	
KWH4-13	13.0	
KWH4-14	14.0	

Part No.	A	Package
KWH4-15	15.0	2000
KWH4-15.9	15.9	
KWH4-16	16.0	
KWH4-17	17.0	
KWH4-18	18.0	
KWH4-19	19.0	
KWH4-20	20.0	1000
KWH4-21	21.0	
KWH4-22	22.0	
KWH4-23	23.0	
KWH4-24	24.0	
KWH4-25	25.0	
KWH4-25.4	25.4	
KWH4-26	26.0	
KWH4-27	27.0	
KWH4-28	28.0	
KWH4-29	29.0	
KWH4-30	30.0	

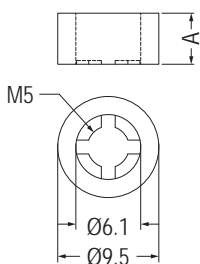
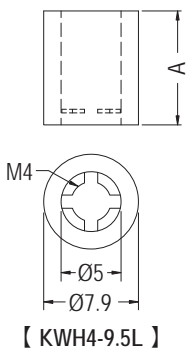

Part No.	A	Package
KWH5-3.2	3.2	2000
KWH5-4.8	4.8	
KWH5-6.4	6.4	
KWH5-7.9	7.9	1000
★ KWH5-9.5	9.5	

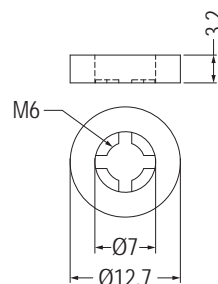

Part No.	Package
KWH6-3.2	1000

間隔柱 SPACER SUPPORT

用途：做為PC板與PC板或機板間之固定不掉落。

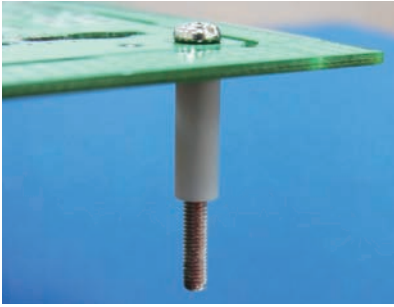

- Material: Nylon 66 (UL)
- Flame Class: 94V-2/94V-0
- Color: Natural/Black
- Unit: mm

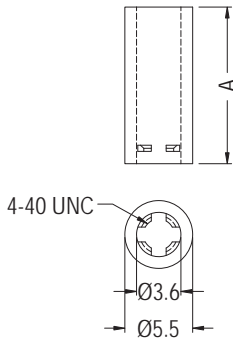

Part No.	A	Package
KWH440-2	2.0	2000
KWH440-3	3.0	
KWH440-4	4.0	
KWH440-5	5.0	
KWH440-6	6.0	
KWH440-6.3	6.3	
KWH440-7	7.0	
KWH440-8	8.0	
KWH440-9	9.0	
KWH440-9.5	9.5	
KWH440-10	10.0	
KWH440-11	11.0	
KWH440-12	12.0	
KWH440-12.7	12.7	
KWH440-13	13.0	
KWH440-14	14.0	
KWH440-15	15.0	

Part No.	A	Package
KWH440-15.9	15.9	2000
KWH440-16	16.0	
KWH440-17	17.0	
KWH440-18	18.0	
KWH440-19	19.0	
KWH440-20	20.0	1000
KWH440-21	21.0	
KWH440-22	22.0	
KWH440-23	23.0	
KWH440-24	24.0	
KWH440-25	25.0	
KWH440-25.4	25.4	
KWH440-26	26.0	
KWH440-27	27.0	
KWH440-28	28.0	
KWH440-29	29.0	
KWH440-30	30.0	

銅柱 STANDOFF

用途：做為PC板與機板間之固定，六角型不滑動。

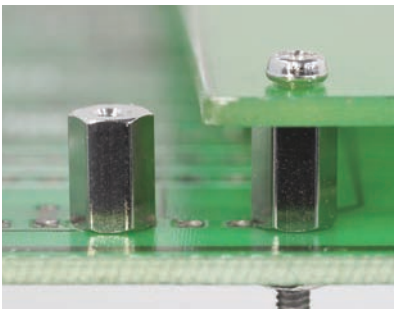

- Material: Brass
- Finish: Nickel Plated
- Unit: mm

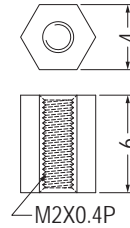

Part No.	Package
BHP2-6	1000

塑膠銅柱 STANDOFF

用途：做為PC板與機板間之固定，六角型不滑動。

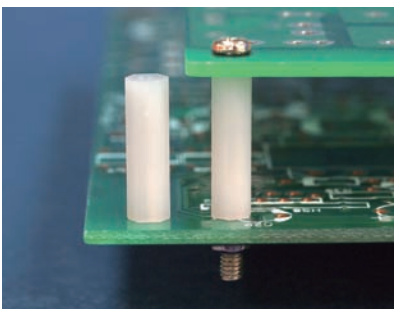

- Material: Nylon 66 (UL)
- Flame Class: 94V-2/94V-0
- Color: Natural/Black
- Unit: mm

Part No.	A	Package
HPS2-4	4.0	1000
HPS2-4.5	4.5	
HPS2-5	5.0	
HPS2-6	6.0	
HPS2-7	7.0	
HPS2-8	8.0	
HPS2-9	9.0	
HPS2-10	10.0	
HPS2-11	11.0	
HPS2-12	12.0	
HPS2-12.7	12.7	

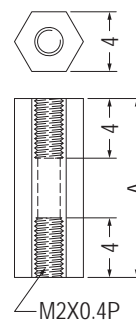

Part No.	A	Package
HPS2-13	13.0	1000
HPS2-14	14.0	
HPS2-15	15.0	
HPS2-16	16.0	
HPS2-17	17.0	
HPS2-18	18.0	
HPS2-19	19.0	
HPS2-20	20.0	
HPS2-21	21.0	
HPS2-22	22.0	
HPS2-23	23.0	
HPS2-24	24.0	
HPS2-25	25.0	

塑膠銅柱 STANDOFF

1

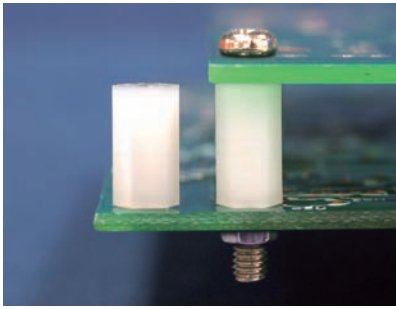

- Material: Nylon 66 (UL)
- Flame Class: 94V-2/94V-0
- Color: Natural/Black
- Unit: mm

用途：做為PC板與機板間之固定，六角型不滑動。

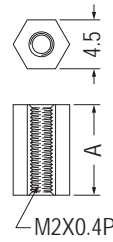

Part No.	A	Package
HP2-4	4.0	1000
HP2-5	5.0	
HP2-6	6.0	
HP2-7	7.0	
HP2-8	8.0	
HP2-9	9.0	
HP2-10	10.0	
HP2-11	11.0	
HP2-12	12.0	

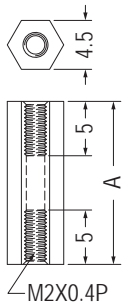

Part No.	A	Package
HP2-13	13.0	1000
HP2-14	14.0	
HP2-15	15.0	
HP2-16	16.0	
HP2-17	17.0	
HP2-18	18.0	
HP2-18.8	18.8	
HP2-19	19.0	

Part No.	A	Package
HP2-20	20.0	1000
HP2-21	21.0	
HP2-22	22.0	
HP2-23	23.0	
HP2-24	24.0	
HP2-25	25.0	
HP2-26	26.0	
HP2-27	27.0	
HP2-28	28.0	

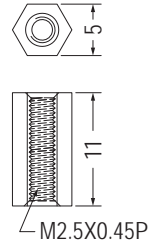

Part No.	Package
HPS2.5-11	1000

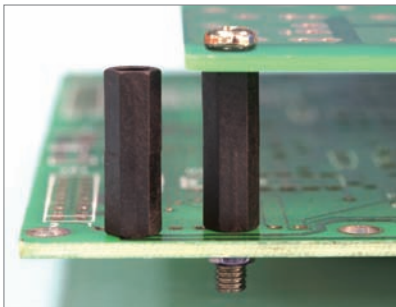

- Material: Nylon 6 (UL)
- Flame Class: 94HB
- Color: Black
- Unit: mm

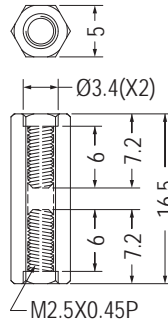

Part No.	Package
HPS2.5-16.5	1000

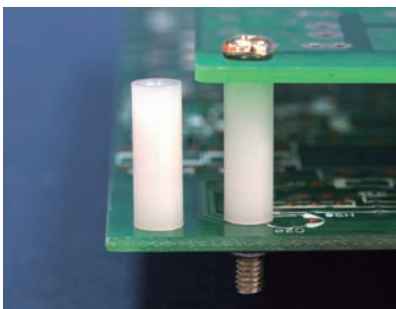

- Material: Nylon 66 (UL)
- Flame Class: 94V-2/94V-0
- Color: Natural/Black
- Unit: mm

用途：做為PC板與機板間之固定。

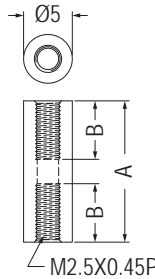

Part No.	A	B	Package
HPP25-14.5	14.5	6.0	1000
HPP25-20	20.0	9.0	

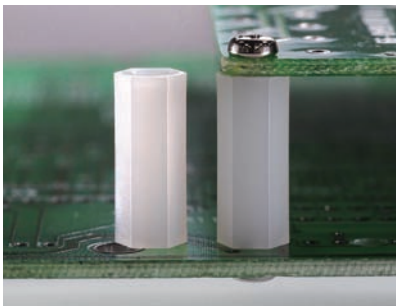

- Material: Nylon 66 (UL)
- Flame Class: 94V-2/94V-0
- Color: Natural/Black
- Unit: mm

用途：做為PC板與機板間之固定，六角型不滑動。

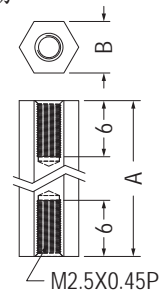
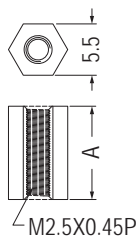

Part No.	A	Package
HP2.5-8	8.0	1000
HP2.5-10	10.0	

Part No.	A	B	Package
★HP2.5-15	15.0	5.5	1000
★HP2.5-15S	15.0	4.0	
★HP2.5-25	25.0	5.5	
★HP2.5-25S	25.0	4.0	
HP2.5-31	31.0	5.5	

塑膠銅柱 STANDOFF

用途：做為PC板與機板間之固定，六角型不滑動。

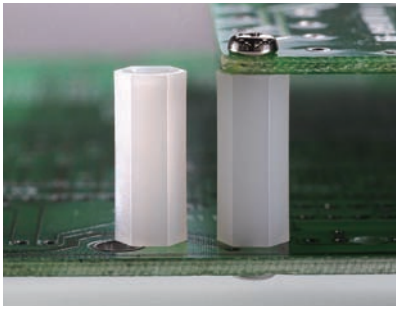

- Material: Nylon 66 (UL)
- Flame Class: 94V-2/94V-0
- Color: Natural/Black
- Unit: mm

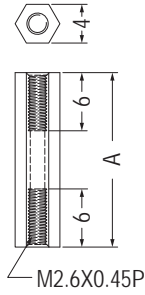

Part No.	A	Package
HPS2.6-18	18.0	1000
HPS2.6-19	19.0	
HPS2.6-31.75	31.75	

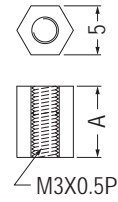

Part No.	A	Package
HPS-6	6.0	1000
HPS-8	8.0	
HPS-10	10.0	
HPS-12	12.0	

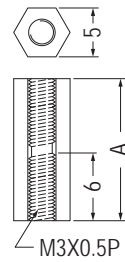
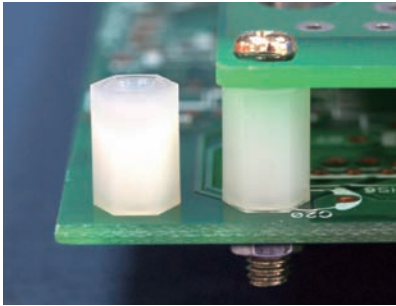

Part No.	A	Package
HPS-15	15.0	1000
HPS-17.4	17.4	
HPS-18	18.0	
HPS-20	20.0	
HPS-25	25.0	

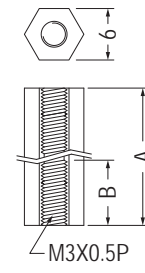
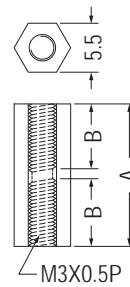
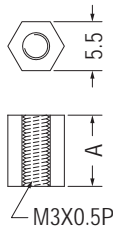

• 產品兩端皆有螺牙可供鎖付

【HP-34】

Part No.	A	Package
HP-4	4.0	1000
HP-5	5.0	
HP-6	6.0	
HP-6.3	6.35	
HP-7	7.0	
HP-8	8.0	
HP-8.5	8.5	
HP-9	9.0	
HP-9.5	9.5	
HP-10	10.0	
HP-10.5	10.5	
HP-11	11.0	
HP-12A	12.0	
HP-12	12.7	

Part No.	A	B	Package
HP-13.5	13.5	6.0	1000
HP-14	14.0	6.0	
HP-14.5	14.5	6.0	
HP-15	15.0	6.0	
HP-15.5	15.5	6.0	
HP-16	16.0	6.0	
HP-16.5	16.5	6.0	
HP-17	17.0	6.0	
HP-17.5	17.5	6.0	
HP-18	18.0	6.0	
HP-19	19.0	6.0	
HP-20	20.0	6.0	
HP-21.5	21.5	6.0	
HP-22	22.0	6.0	

Part No.	A	B	Package
HP-24	24.0	6.0	1000
HP-25	25.0	6.0	
HP-26	26.0	6.0	
HP-27	27.0	6.0	
HP-28	28.0	6.0	
HP-28.6	28.6	6.0	
HP-30	30.0	6.0	
HP-30.8	30.8	6.0	
HP-32	32.0	6.0	
HP-34	34.0	8.0	
HP-35	35.0	6.0	500
HP-37	37.0	6.0	
HP-38	38.0	6.0	
HP-40	40.0	6.0	
HP-42	42.0	6.0	
HP-45	45.0	6.0	
HP-47	47.0	6.0	
HP-49	49.0	6.0	
HP-50	50.0	6.0	
HP-52	52.0	6.0	
HP-54	54.0	6.0	
HP-55.5	55.5	8.0	
HP-60.2	60.2	6.0	
HP-70	70.0	10.0	
HP-76.7	76.7	8.5	

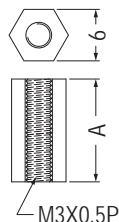

Part No.	A	Package
HPH-10	10.0	1000
HPH-12	12.0	
HPH-15	15.0	

塑膠銅柱 STANDOFF

用途：做為PC板與機板間之固定，六角型不滑動。

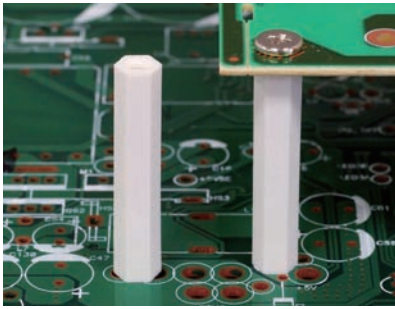

- Material: Nylon 66 (UL)
- Flame Class: 94V-2/94V-0
- Color: Natural/Black
- Unit: mm

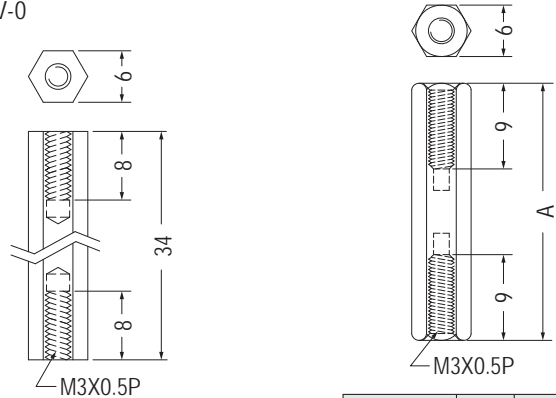

Part No.	Package
HPL-30	1000
HPH-34	1000

Part No.	A	Package
HPL-30	30.0	500
HPL-40	40.0	

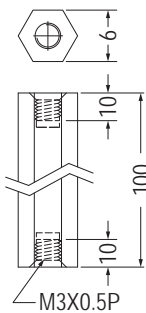
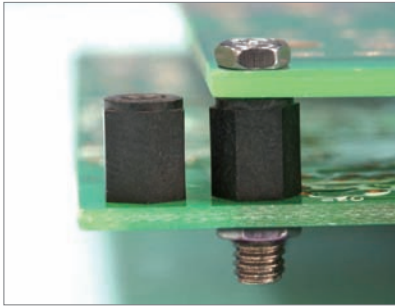

Part No.	Package
HPL-100	500

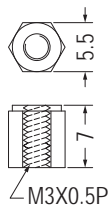

Part No.	Package
HPR3-7	1000

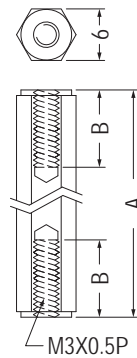

Part No.	A	B	Package
HPR-20	20.0	8.0	1000
HPR3-30	30.0	10.0	

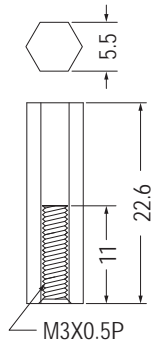

Part No.	Package
HPA3-22.6	1000

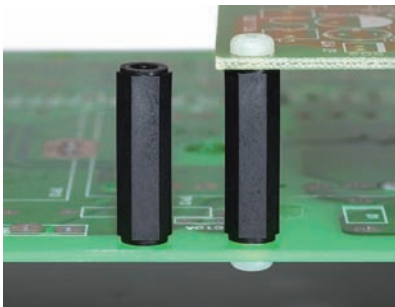

- Material: Nylon 6 (UL)+GF
- Flame Class: 94HB
- Color: Black

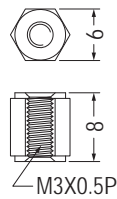

Part No.	Package
HPR-8	1000

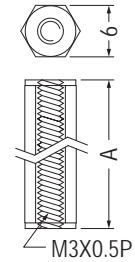

Part No.	A	Package
★HPR3-11	11.0	1000
HPR3-22	22.0	

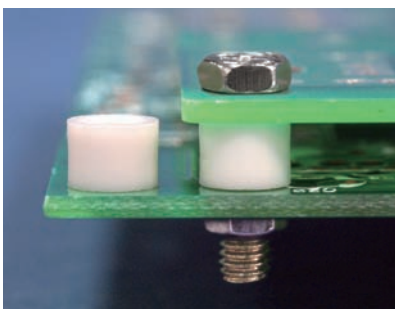

- Material: Nylon 66 (UL)
- Flame Class: 94V-2/94V-0
- Color: Natural/Black
- Unit: mm

用途：做為PC板與機板間之固定。

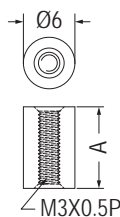

Part No.	A	Package
HPP3-9	9.0	1000
HPP3-9.5	9.5	

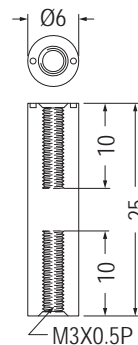

Part No.	Package
HPP3-25	1000

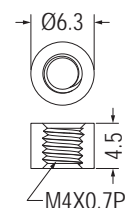

Part No.	Package
HPP4-4.5	1000

塑膠銅柱 STANDOFF

用途：做為PC板與機板間之固定，六角型不滑動。

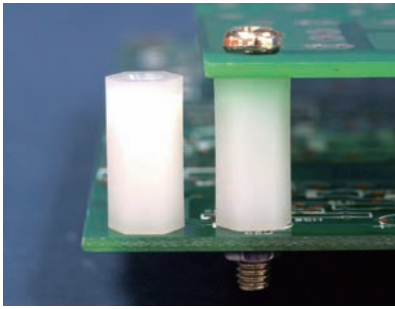

- Material: Nylon 66 (UL)
- Flame Class: 94V-2/94V-0
- Color: Natural/Black
- Unit: mm

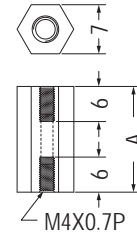
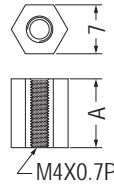

NEW

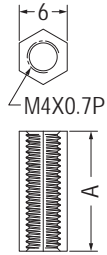

Part No.	A	Package
HPS4-6	6.0	1000
HPS4-8	8.0	
HPS4-10	10.0	
HPS4-12	12.0	
HPS4-15	15.0	
HPS4-18	18.0	
HPS4-20	20.0	

Part No.	A	Package
HP4-6	6.0	1000
HP4-7	7.0	
HP4-8	8.0	
HP4-9	9.0	
HP4-10	10.0	
HP4-11	11.0	
HP4-12	12.0	
HP4-12.7	12.7	

Part No.	A	Package
HP4-14	14.0	1000
HP4-16	16.0	
HP4-20	20.0	
HP4-25	25.0	
HP4-26	26.0	
HP4-30	30.0	
HP4-35	35.0	
HP4-40	40.0	
HP4-45S	45.0	
HP4-45	45.5	

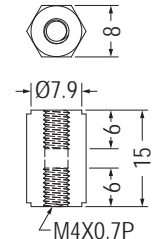
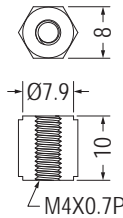
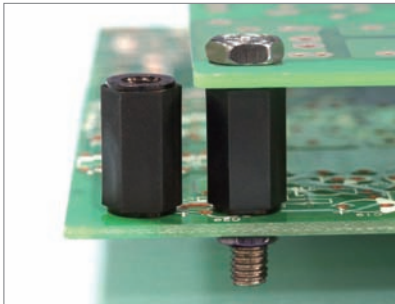

Part No.	Package
HPR4-10	1000

Part No.	Package
HPR4-15	1000

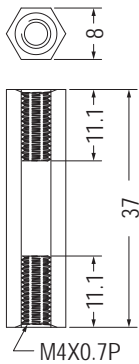

Part No.	Package
HPL4-37	1000

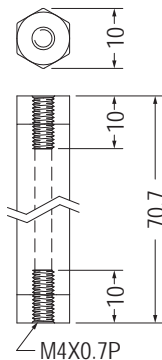

Part No.	Package
HPR4-70L	500

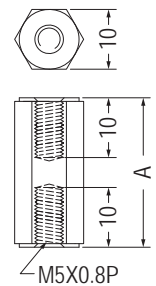

Part No.	A	Package
HPR5-25	25.0	1000
HPR5-45	45.0	500

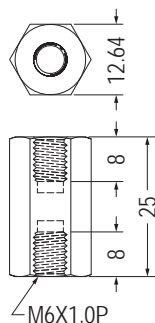
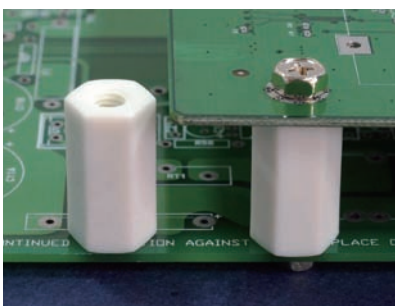

Part No.	Package
HP6-25	500

塑膠銅柱 STANDOFF

用途：做為牙管的延伸與對接。



- Material: PC+ABS (UL)
- Flame Class: 94V-0
- Color: Black
- Unit: mm

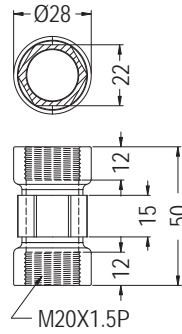

Part No.	Package
HP2050	1000



- Material: Nylon 66 (UL)
- Flame Class: 94V-2/94V-0
- Color: Natural/Black
- Unit: mm

用途：做為斷路器保護，避免誤觸。

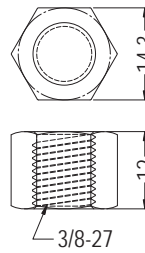

Part No.	Package
M-3/8-27	1000

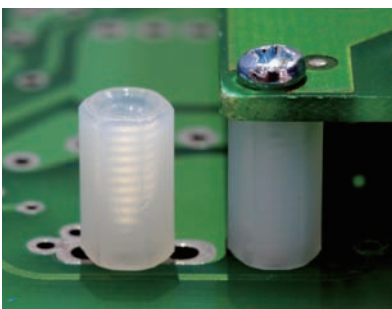

- Material: Nylon 66 (UL)
- Flame Class: 94V-2/94V-0
- Color: Natural/Black
- Unit: mm

用途：做為PC板與機板間之固定，六角型不滑動。

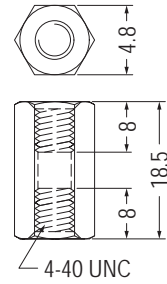
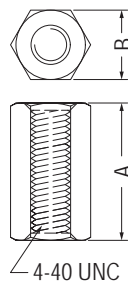

Part No.	A	B	Package
HP440-7.9S	7.9	4.75	1000
HP440-9.5	9.5	4.8	
HP440-15.9S	15.88	4.75	

Part No.	Package
HP440-18	1000

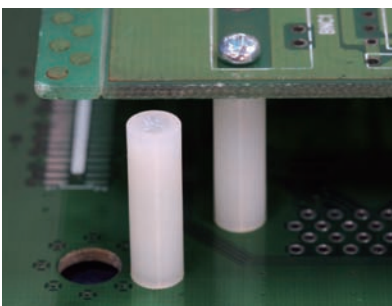

- Material: Nylon 66 (UL)
- Flame Class: 94V-2/94V-0
- Color: Natural/Black
- Unit: mm

用途：做為PC板與機板間之固定。

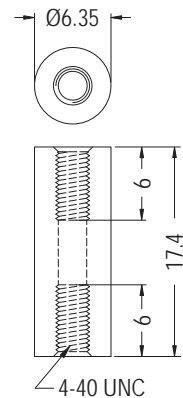
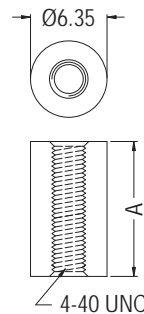
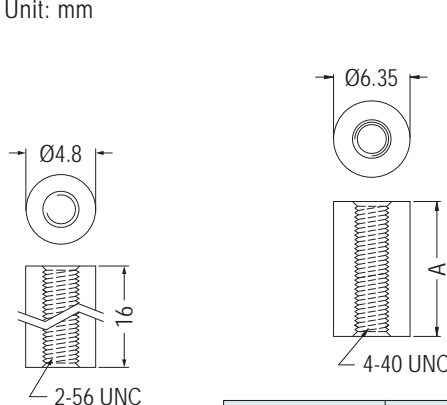

Part No.	Package
HP256-16	1000

Part No.	A	Package
HPP440-6.35	6.35	1000
HPP440-11.2	11.2	

Part No.	Package
HPP440-17.4	1000

塑膠銅柱 STANDOFF

用途：做為PC板與機板間之固定，六角型不滑動。

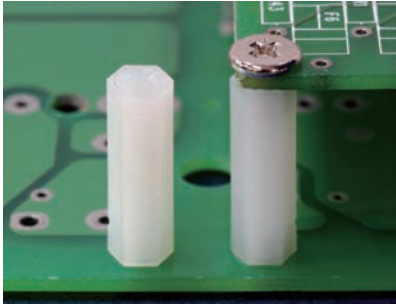
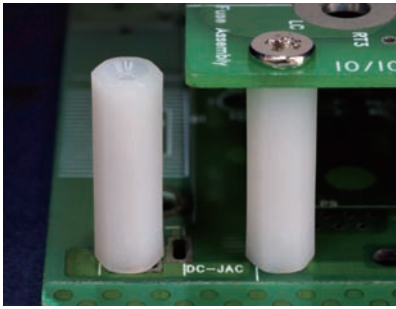

- Material: Nylon 66 (UL)
- Flame Class: 94V-2/94V-0
- Color: Natural/Black
- Unit: mm

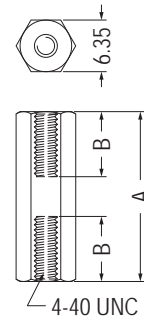
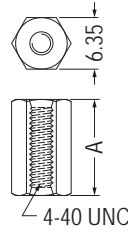

Part No.	A	Package
HP44L-6.35	6.35	1000
HP44L-8	8.0	
HP44L-9.5	9.5	
HP44L-12.7	12.7	
HP44L-15.9	15.9	
HP44L-19.1	19.1	

Part No.	A	B	Package
HP44L-22	22.2	9.0	1000
HP44L-23.8	23.8	6.4	
HP44L-25.4	25.4	9.0	
HP44L-28.6	28.6	6.4	

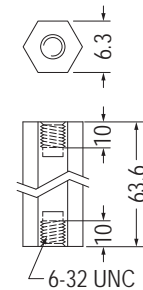
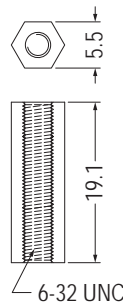
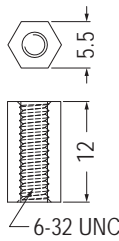

Part No.	Package
HPS632-12	1000

Part No.	Package
HPS632-19.1	1000

Part No.	Package
HP632-64	250

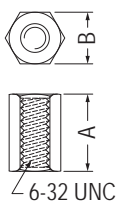

Part No.	A	B	Package
HP632-6.4	6.4	6.35	1000
HP632-9.5	9.5	6.35	
HP632-12.7	12.7	6.35	
HP632-15.9	15.9	6.35	
HP632-19.1	19.1	6.35	
HP632-22.2	22.2	6.35	
HP632-25.4	25.4	6.4	

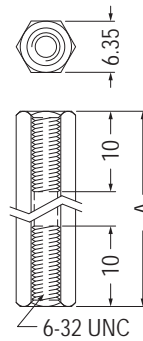

Part No.	A	Package
HP632-28.5	28.5	1000
HP632-31.8	31.8	
HP632-38.1	38.1	

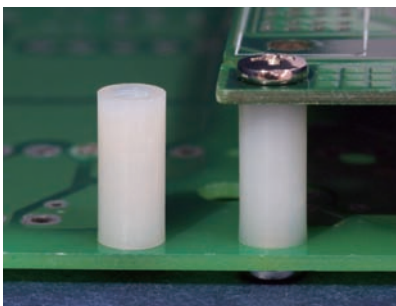

- Material: Nylon 66 (UL)
- Flame Class: 94V-2/94V-0
- Color: Natural/Black
- Unit: mm

用途：做為PC板與機板間之固定。

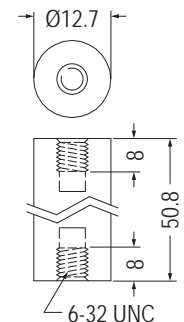
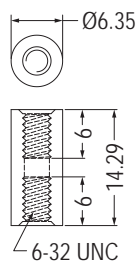

Part No.	Package
HPP632-14	1000

Part No.	Package
HPP632-51	200

塑膠銅柱 STANDOFF

用途：做為PC板與機板間之固定。

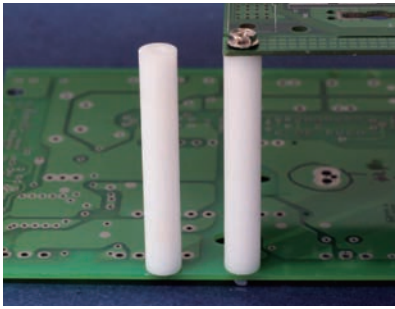

- Material: POM (UL)
- Flame Class: 94HB
- Color: Natural
- Unit: mm

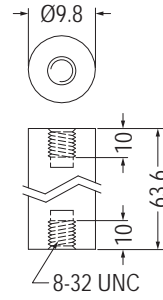

Part No.	Package
HPP10-64	250

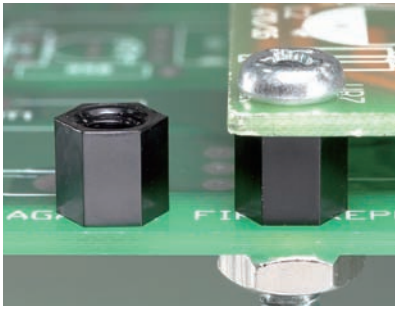

- Material: Nylon 66 (UL)
- Flame Class: 94V-2/94V-0
- Color: Natural/Black
- Unit: mm

用途：做為PC板與機板間之固定，六角型不滑動。

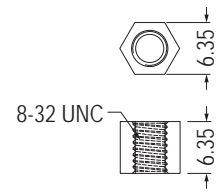
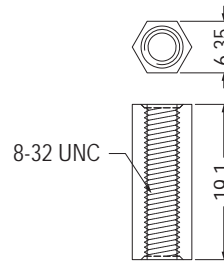
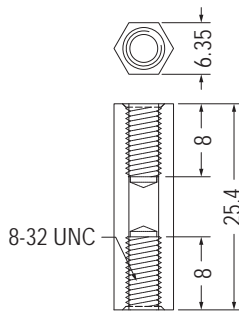

- Material: Nylon 46 (UL)
- Flame Class: 94V-2
- Color: Black

Part No.	Package
★HP832-25.4	1000

Part No.	Package
HP832-19.1	1000

Part No.	Package
HP832-6.35	1000

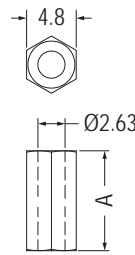
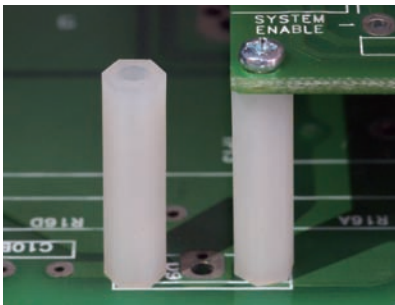

無攻牙

CLEAR WITHOUT TAPPING

Part No.	A	Package
HP48-20	20.0	1000
HP48-32	32.0	

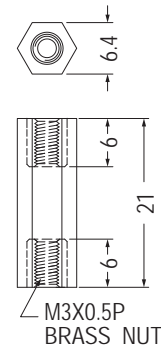
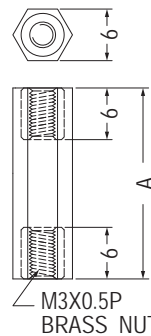
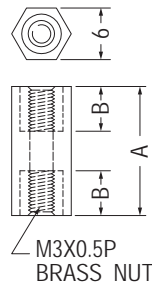
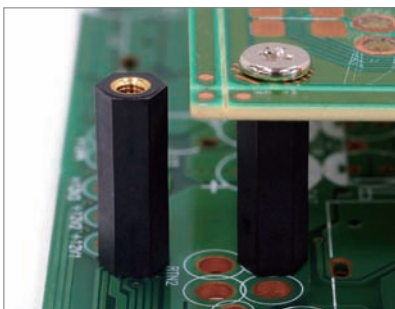

Part No.	A	B	Package
HPC-11.9	11.9	4.0	1000
HPC-15	15.0	4.5	

Part No.	A	Package
HPC-19	19.0	1000
HPC-30	30.0	
HPC-45	45.0	

Part No.	Package
HPC-21	1000

塑膠銅柱 STANDOFF

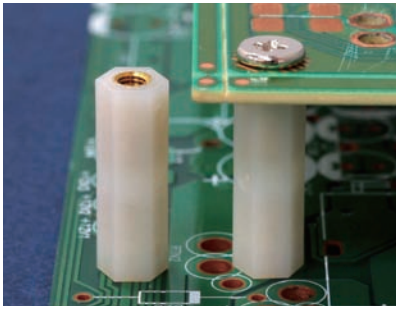

- Material: Nylon 66 (UL)
- Flame Class: 94V-2/94V-0
- Color: Natural/Black
- Unit: mm

用途：做為PC板與機板間之固定，六角型不滑動。

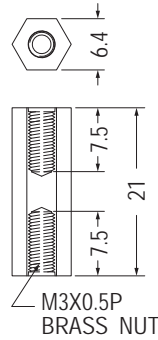

Part No.	Package
HPCA-21	1000

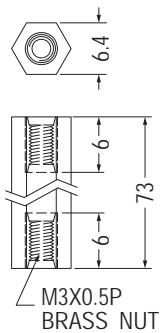

Part No.	Package
HPC-73	1000

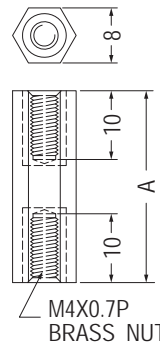

Part No.	A	Package
HPC4-30	30.0	250
HPC4-35	35.0	
HPC4-40	40.0	

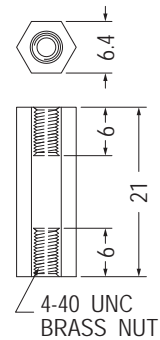

Part No.	Package
HPC44-21	1000

塑膠螺柱 THREADED SPACER

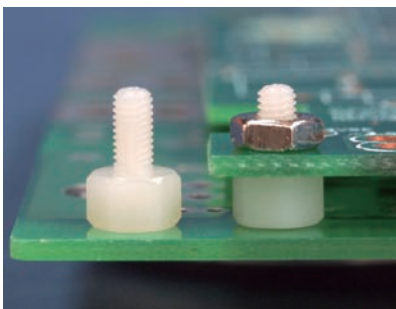

- Material: Nylon 66 (UL)
- Flame Class: 94V-2/94V-0
- Color: Natural/Black
- Unit: mm

用途：做為於零件之墊高。

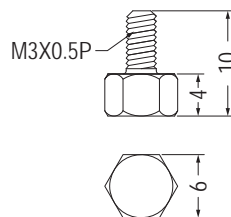

Part No.	Package
TPA-4	1000

塑膠銅柱 STANDOFF

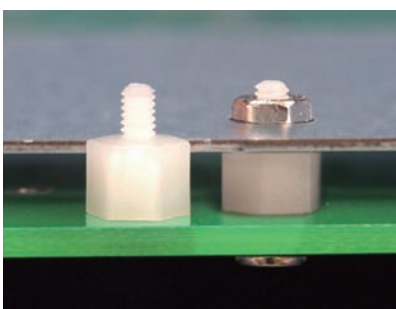

- Material: Nylon 66 (UL)
- Flame Class: 94V-2/94V-0
- Color: Natural/Black
- Unit: mm

用途：做為PC板與機板間之固定，一端配合螺絲，另一端配合螺帽使用。

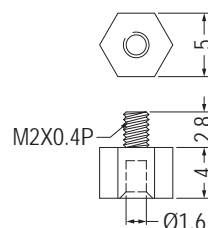

Part No.	Package
TP2L-4	1000

塑膠銅柱 STANDOFF

用途：做為PC板與機板間之固定，一端配合螺絲，另一端配合螺帽使用。

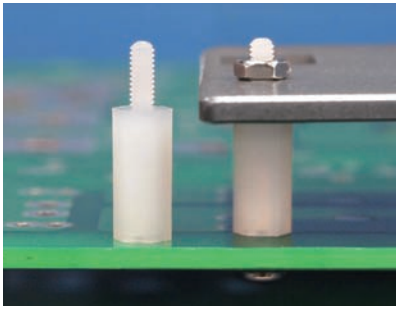

- Material: Nylon 66 (UL)
- Flame Class: 94V-2/94V-0
- Color: Natural/Black
- Unit: mm

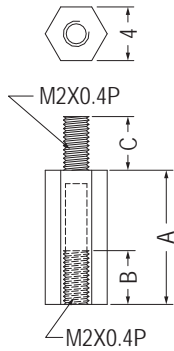

Part No.	A	B	C	Package
TP2-5S	5.0	3.0	4.0	1000
TP2-6.5S	6.5	4.0	4.0	
TP2-8S	8.0	4.0	4.0	
TP2-10S	10.0	4.0	4.0	
TP2-15S	15.0	4.0	4.0	
TP2-4	4.0	2.5	5.0	
TP2-5	5.0	3.0	5.0	
TP2-5.5	5.5	3.0	5.0	
TP2-6	6.0	4.0	5.0	
TP2-6.5	6.5	4.0	5.0	
TP2-7	7.0	4.0	5.0	
TP2-8	8.0	5.0	5.0	
TP2-9	9.0	5.0	5.0	
TP2-10	10.0	5.0	5.0	
TP2-11	11.0	5.0	5.0	
TP2-12	12.0	5.0	5.0	

Part No.	A	B	C	Package
TP2-13	13.0	5.0	5.0	1000
TP2-14	14.0	5.0	5.0	
TP2-15	15.0	5.0	5.0	
TP2-16	16.0	5.0	5.0	
TP2-17	17.0	5.0	5.0	
TP2-18	18.0	5.0	5.0	
TP2-19	19.0	5.0	5.0	
TP2-20	20.0	5.0	5.0	
TP2-21	21.0	5.0	5.0	
TP2-22	22.0	5.0	5.0	
TP2-23	23.0	5.0	5.0	
TP2-24	24.0	5.0	5.0	
TP2-25	25.0	5.0	5.0	
TP2-26	26.0	5.0	5.0	
TP2-27	27.0	5.0	5.0	
TP2-28	28.0	5.0	5.0	

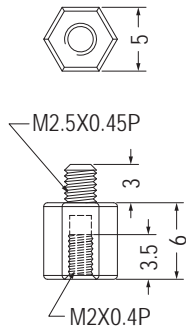

Part No.	Package
TP2.5-2-6	1000

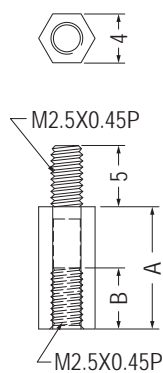

Part No.	A	B	Package
TP2.5-5	5.0	3.0	1000
TP2.5-6	6.0	4.0	
TP2.5-7	7.0	5.0	
TP2.5-8	8.0	5.0	
TP2.5-9	9.0	5.0	
TP2.5-10	10.0	5.0	
TP2.5-11	11.0	5.0	
TP2.5-12	12.0	5.0	
TP2.5-13	13.0	5.0	
TP2.5-14	14.0	5.0	
TP2.5-15	15.0	5.0	
TP2.5-16	16.0	5.0	

Part No.	A	B	Package
TP2.5-17	17.0	5.0	1000
TP2.5-18	18.0	5.0	
TP2.5-19	19.0	5.0	
TP2.5-20	20.0	5.0	
TP2.5-21	21.0	5.0	
TP2.5-22	22.0	5.0	
TP2.5-23	23.0	5.0	
TP2.5-24	24.0	5.0	
TP2.5-24.5	24.5	5.0	
TP2.5-25	25.0	5.0	
TP2.5-26	26.0	5.0	
TP2.5-27	27.0	5.0	
TP2.5-28	28.0	5.0	

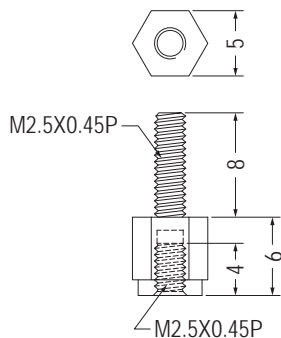

Part No.	Package
TP2.5-6L	1000

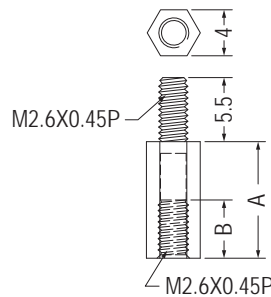

Part No.	A	B	Package
TP2.6-4	4.0	2.0	1000
TP2.6-5	5.0	3.0	
TP2.6-6	6.0	4.0	
TP2.6-7	7.0	5.0	
TP2.6-8	8.0	5.5	
TP2.6-9	9.0	5.5	
TP2.6-10	10.0	5.5	
TP2.6-11	11.0	5.5	
TP2.6-12	12.0	5.5	
TP2.6-12.7	12.7	5.5	

Part No.	A	B	Package
TP2.6-13	13.0	5.5	1000
TP2.6-14	14.0	5.5	
TP2.6-15	15.0	5.5	
TP2.6-16	16.0	5.5	
TP2.6-17	17.0	5.5	
TP2.6-18	18.0	5.5	
TP2.6-19	19.0	5.5	
TP2.6-20	20.0	5.5	
TP2.6-21	21.0	5.5	
TP2.6-22	22.0	5.5	
TP2.6-23	23.0	5.5	
TP2.6-24	24.0	5.5	
TP2.6-25	25.0	5.5	
TP2.6-26	26.0	5.5	
TP2.6-27	27.0	5.5	
TP2.6-28	28.0	5.5	

塑膠銅柱 STANDOFF

用途：做為PC板與機板間之固定，一端配合螺絲，另一端配合螺帽使用。

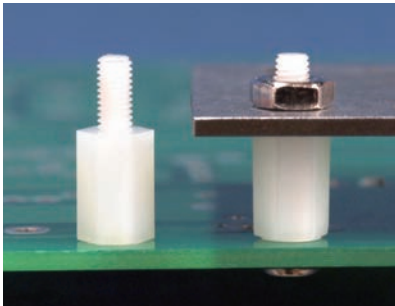
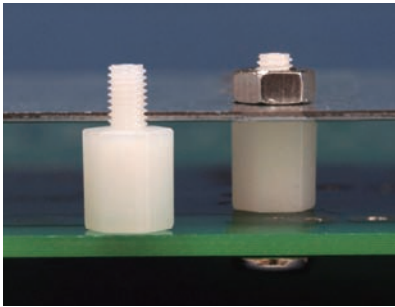

- Material: Nylon 66 (UL)
- Flame Class: 94V-2/94V-0
- Color: Natural/Black
- Unit: mm

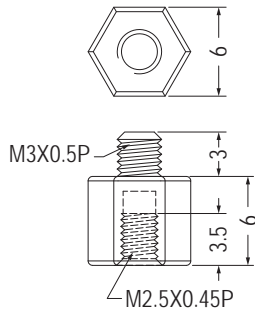

Part No.	Package
TP3-2.5-6	1000

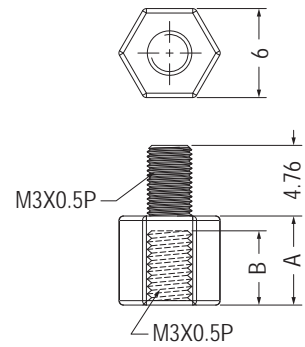

Part No.	A	B	Package
★TP3-6	6.0	5.0	1000
TP3-7.5	7.5	6.25	

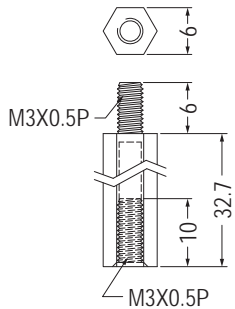

Part No.	Package
TP-32.7L	1000

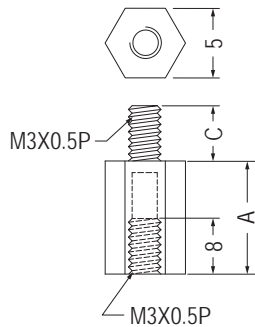

Part No.	A	C	Package
TPS-10S	10.0	5.0	1000
TPS-10	10.0	8.0	
TPS-12	12.0	8.0	
TPS-13	13.0	8.0	
TPS-15	15.0	8.0	
TPS-18	18.0	8.0	
TPS-20	20.0	8.0	
TPS-25	25.0	8.0	

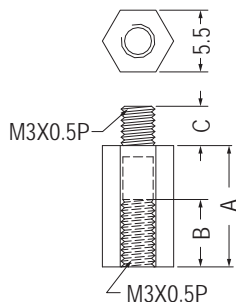

Part No.	A	B	C	Package
TP-5S	5.0	4.0	3.5	1000
TP-5SM	5.0	4.0	5.0	
TP-6S	6.0	4.0	5.0	
TP-7-4	7.0	5.0	4.0	
TP-9-4	9.0	6.0	4.0	
TP-10.8	10.8	6.0	3.5	
TP-11.2	11.2	6.0	3.5	
TP-16S	16.0	6.0	4.0	
TP-18S	18.0	6.0	5.0	
TP-20S	20.0	8.0	5.0	

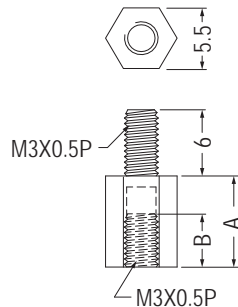

Part No.	A	B	Package
TP-4	4.0	3.0	1000
TP-5	5.0	3.0	
TP-6	6.0	4.0	
TP-7	7.0	5.0	
TP-7.5	7.5	5.0	
TP-8	8.0	6.0	
TP-8.5	8.5	6.0	
TP-9	9.0	6.0	
TP-9.5	9.5	6.0	
TP-10	10.0	6.0	
TP-10.5	10.5	6.0	
TP-10.8L	10.8	6.0	
TP-11	11.0	6.0	
TP-12A	12.0	6.0	
TP-12	12.7	6.0	
TP-13	13.0	6.0	

Part No.	A	B	Package
TP-14	14.0	6.0	1000
TP-15	15.0	6.0	
TP-15.5	15.5	6.0	
TP-16	16.0	6.0	
TP-16.5	16.5	6.0	
TP-17	17.0	6.0	
TP-18	18.0	6.0	
TP-18.5	18.5	6.0	
TP-19	19.0	6.0	
TP-20	20.0	8.0	
TP-21	21.0	6.0	
TP-22	22.0	6.0	
TP-24.5	24.5	6.0	
TP-25	25.0	6.0	
TP-27	27.0	6.0	
TP-28	28.0	6.0	
TP-28.5	28.5	6.0	
TP-30	30.0	8.0	
TP-33	33.0	6.0	
TP-34.5	34.5	6.0	
TP-35	35.0	6.0	
TP-36	36.0	6.0	
TP-37	37.0	6.0	
TP-40	40.0	6.0	
TP-45	45.0	6.0	
TP-53.5	53.5	6.0	
TP-55.5	55.5	8.0	

塑膠銅柱 STANDOFF

用途：做為PC板與機板間之固定，一端配合螺絲，另一端配合螺帽使用。

1

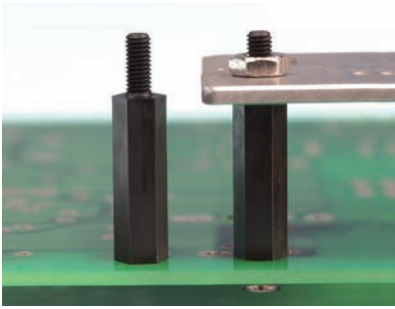

- Material: POM
- Color: Black
- Unit: mm

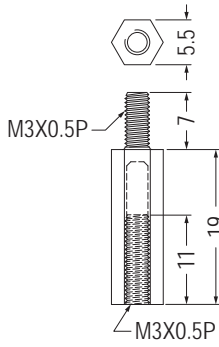

Part No.	Package
TPD-19	1000

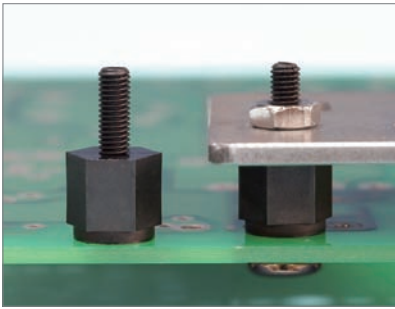

- Material: Nylon 66 (UL)
- Flame Class: 94V-2/94V-0
- Color: Natural/Black
- Unit: mm

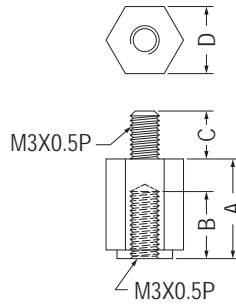

Part No.	A	B	C	D	Package
TP3-6L	6.0	4.0	8.0	6.0	1000
★TP3-8L	8.0	6.0	8.0	6.0	
TP3-10L	10.0	8.0	8.0	6.0	
TP3-10.4	10.4	7.0	5.0	7.0	
TP3-11L	11.0	9.0	8.0	6.0	
TP3-12L	12.0	10.0	8.0	6.0	
★TP3-15L	15.0	10.0	8.0	6.0	
TP3-18L	18.0	10.0	8.0	6.0	
★TP3-50L	50.0	10.0	8.0	6.0	500

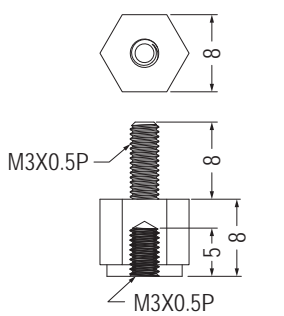
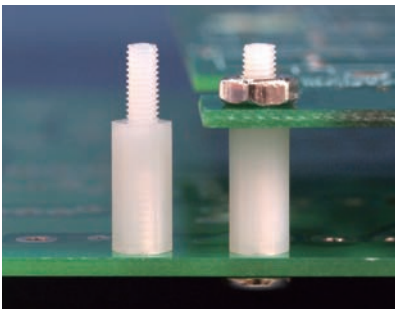

Part No.	Package
TP-8L	1000

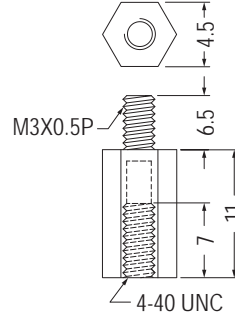

Part No.	Package
TPS44-11	1000

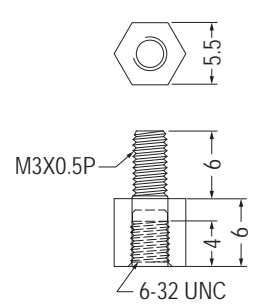

Part No.	Package
TPS632-6	1000

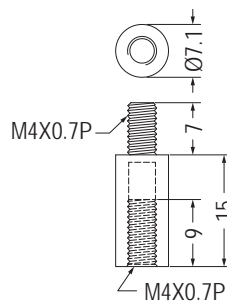
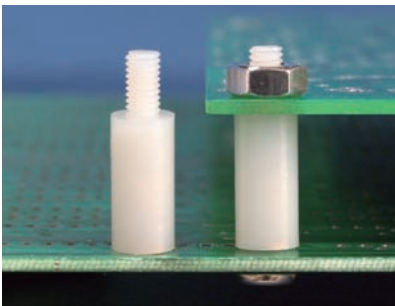

Part No.	Package
TPR4-15	1000

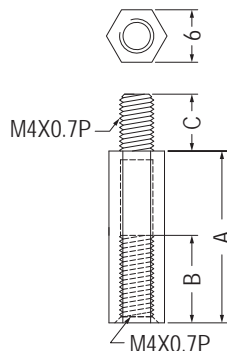
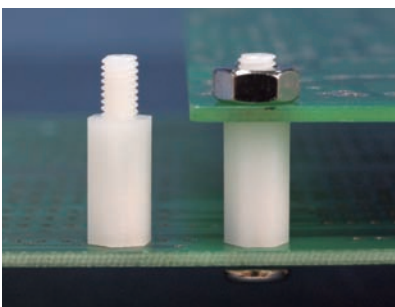

Part No.	A	B	C	Package
TPS4-10L	10.0	8.0	9.5	1000
TPS4-12L	12.0	8.0	9.5	
TPS4-13	13.0	6.0	6.5	
TPS4-15L	15.0	12.0	9.5	
★TPS4-20L	20.0	12.0	9.5	
TPS4-25L	25.0	12.0	9.5	
TPS4-30	30.0	10.0	6.5	
TPS4-55	55.0	10.0	6.5	

塑膠銅柱 STANDOFF

用途：做為PC板與機板間之固定，一端配合螺絲，另一端配合螺帽使用。

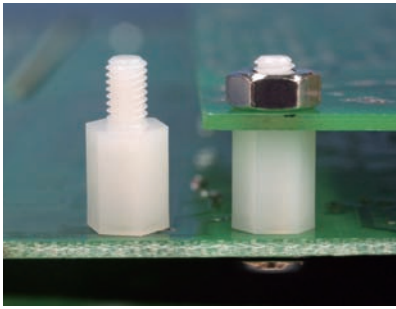

- Material: Nylon 66 (UL)
- Flame Class: 94V-2/94V-0
- Color: Natural/Black
- Unit: mm

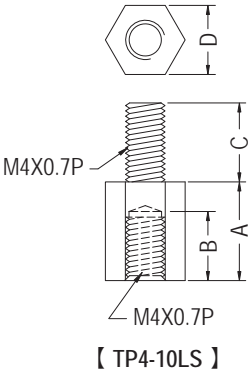

Part No.	A	B	C	D	Package
TP4-6	6.0	4.0	6.5	7.0	1000
TP4-8	8.0	6.0	6.5	7.0	
TP4-10	10.0	6.0	6.5	7.0	
TP4-10LS	10.0	7.0	8.0	7.0	
TP4-10L	10.0	7.0	8.0	8.0	

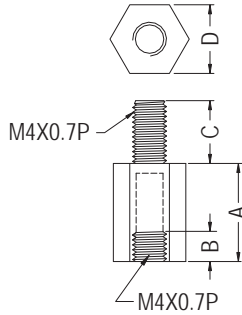

Part No.	A	B	C	D	Package
TP4-12	12.0	6.0	6.5	7.0	1000
TP4-13	13.0	6.0	6.5	7.0	
TP4-14	14.0	6.0	6.5	7.0	
TP4-15	15.0	6.0	6.5	7.0	
TP4-16	16.0	7.0	6.5	7.0	
TP4-17	17.0	7.0	6.5	7.0	
TP4-19	19.0	7.0	6.5	7.0	
TP4-20	20.0	8.0	6.5	7.0	
TP4-25	25.0	8.0	6.5	7.0	
TP4-27	27.0	8.0	6.5	7.0	
TP4-30	30.0	8.0	6.5	7.0	
TP4-34	34.0	8.0	6.5	7.0	
TP4-35	35.0	8.0	6.5	7.0	
TP4-37	37.0	8.0	6.5	7.0	
TP4-40	40.0	8.0	6.5	7.0	
TP4-45	45.5	8.0	6.5	7.0	
TP4-57	57.0	8.0	6.5	7.0	

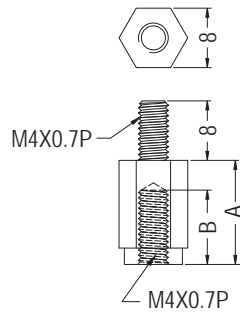
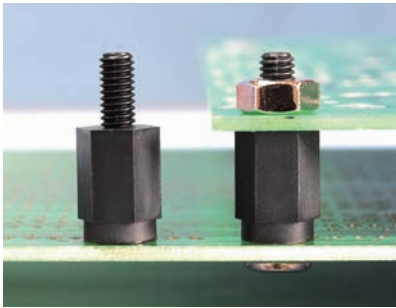

Part No.	A	B	Package
TP4-8L	8.0	6.0	1000
TP4-10R	10.0	8.0	
TP4-11R	11.0	9.0	
TP4-12L	12.0	10.0	
TP4-14L	14.0	10.0	
TP4-20L	20.0	10.0	
TP4-32L	32.0	10.0	500
TP4-35L	35.0	10.0	

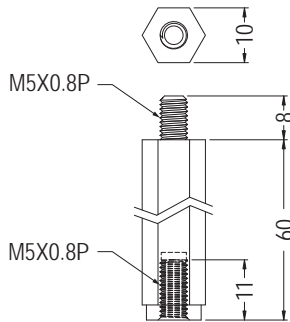
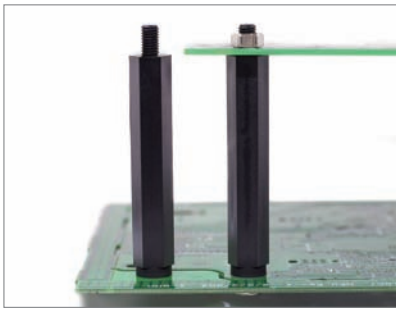

Part No.	Package
TP5-60	250

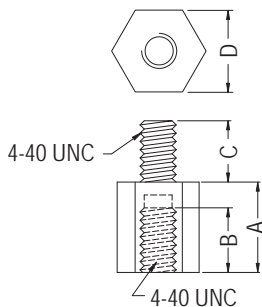
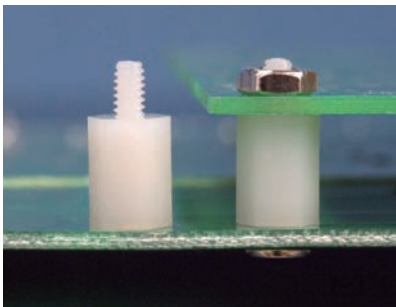

Part No.	A	B	C	D	Package
TP440-6.4	6.4	4.0	4.8	6.4	1000
TP440-6.4-4.8	6.4	4.8	4.8	6.4	
TP440-7	7.0	4.0	4.8	6.4	
TP440-8S	8.0	6.35	4.8	4.8	
TP440-9.5	9.5	6.0	4.8	6.4	
TP440-12.7	12.7	6.0	4.8	6.4	
TP440-15.2	15.24	4.75	4.75	6.35	
TP440-15.9	15.9	6.0	4.8	6.4	
TP440-19.1	19.1	6.0	4.8	6.4	
TP440-19.1S	19.05	6.35	4.75	4.75	
TP440-22.2	22.2	4.75	4.75	6.35	
TP440-25.4	25.4	4.75	4.75	6.35	
TP440-28.7	28.7	6.0	4.8	6.4	

塑膠銅柱 STANDOFF

用途：做為PC板與機板間之固定，一端配合螺絲，另一端配合螺帽使用。

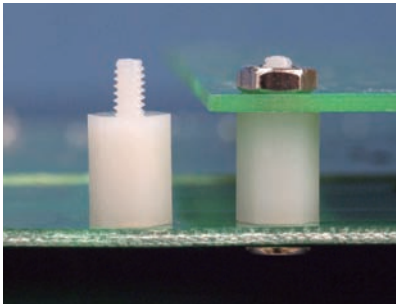

- Material: Nylon 66 (UL)
- Flame Class: 94V-2/94V-0
- Color: Natural/Black
- Unit: mm

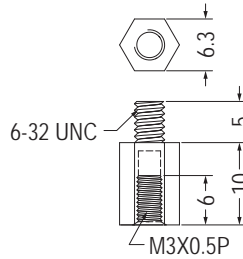

Part No.	Package
TP632-M310	1000

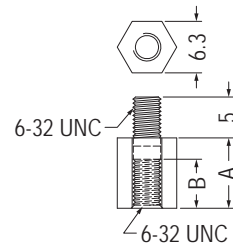
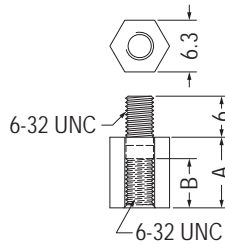

Part No.	A	B	Package
TP632-5	5.0	3.0	1000
TP632-5.5	5.5	3.5	
TP632-6	6.0	4.0	
TP632-6.3	6.3	4.0	
TP632-8	8.0	6.0	
TP632-9	9.0	6.0	
TP632-10	10.0	6.0	
TP632-11	11.0	6.0	
TP632-12	12.0	6.0	
TP632-12.7	12.7	6.0	
TP632-15.9	15.9	6.0	
TP632-19.1	19.1	6.0	
TP632-25.4	25.4	6.0	
TP632-28.6	28.6	9.5	
TP632-31.8	31.8	6.0	
TP632-51	51.0	6.0	

Part No.	A	B	Package
TP632-5S	5.0	3.0	1000
TP632-5.5S	5.5	3.5	
TP632-6S	6.0	4.0	
TP632-6.3S	6.3	4.0	
TP632-8S	8.0	6.0	
TP632-9S	9.0	6.0	
TP632-10S	10.0	6.0	
TP632-11S	11.0	6.0	
TP632-12S	12.0	6.0	
TP632-12.7S	12.7	6.0	
TP632-15.9S	15.9	6.0	
TP632-19.1S	19.1	6.0	
TP632-25.4S	25.4	6.0	
TP632-31.8S	31.8	6.0	

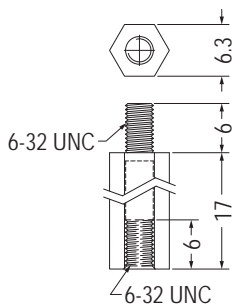

- Material: Nylon 46 (UL)
- Flame Class: 94V-2
- Color: Black

Part No.	Package
★TP632-17	1000

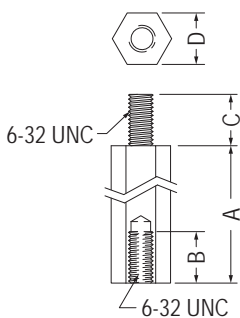

Part No.	A	B	C	D	Package
TP632-9.5L	9.5	6.4	6.4	6.4	1000
TP632-17.5L	17.5	6.4	6.4	6.4	
TP632-31.8L	31.8	6.35	6.35	6.35	
TP632-34.9L	34.9	6.35	6.35	6.35	
TP632-38.1L	38.1	6.35	6.35	6.35	
TP632-41.3L	41.3	6.35	6.35	6.35	
TP632-44.5L	44.5	6.35	6.35	6.35	500
TP632-50.8L	50.8	6.35	6.35	6.35	

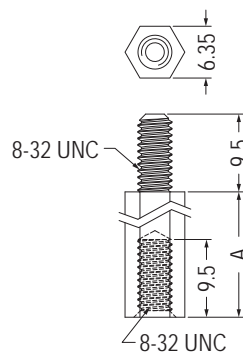

Part No.	A	Package
TP832-12.7	12.7	1000
TP832-19.1	19.1	
TP832-22.2	22.2	

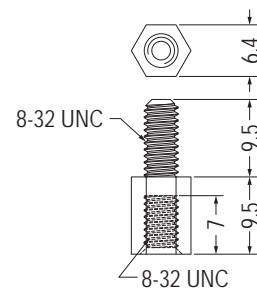

- Material: Nylon 46 (UL)
- Flame Class: 94V-2
- Color: Black

Part No.	Package
TP832-9.5	1000

塑膠銅柱 STANDOFF

用途：PC板與PC板間之固定，不佔空間。

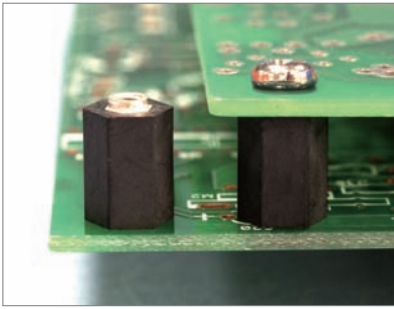

- Material: Nylon 66 (UL)
- Flame Class: 94V-2/94V-0
- Color: Natural/Black
- Unit: mm

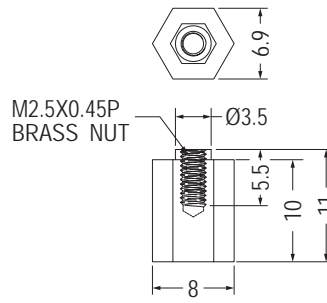

Part No.	Package
HPB2.5-10	1000

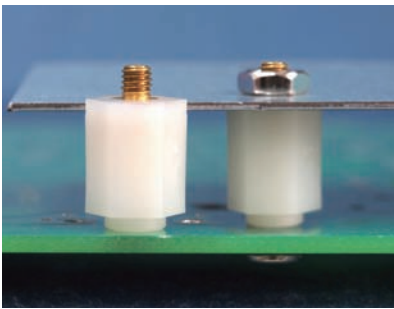

- Material: Nylon 66 (UL)
- Flame Class: 94V-2/94V-0
- Color: Natural/Black
- Unit: mm

用途：做為PC板與機板間之固定，一端配合螺絲，另一端配合螺帽使用。

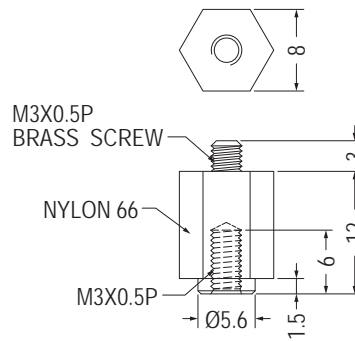

Part No.	Package
MTPE3-12	1000

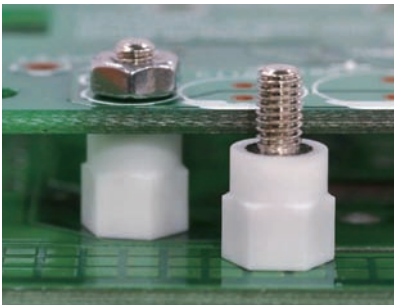

- Material: Nylon 6 (UL)
- Flame Class: 94V-0
- Color: Natural
- Unit: mm

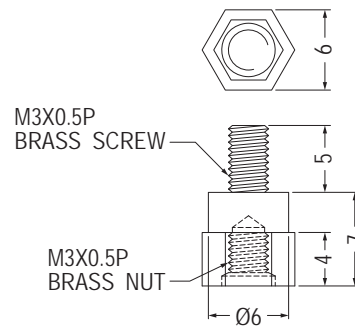

Part No.	Package
MTPF3-7	1000

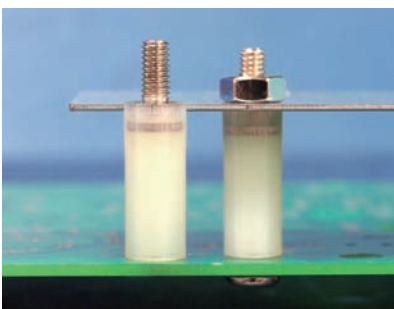

- Material: Nylon 66 (UL)
- Flame Class: 94V-2/94V-0
- Color: Natural/Black
- Unit: mm

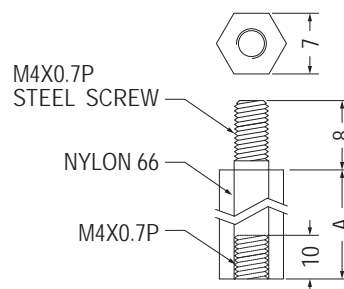

Part No.	A	Package
MTPC4-20	20.0	1000
MTPC4-57	57.0	

塑膠銅柱 STANDOFF

用途：PC板與PC板間之固定，不佔空間。

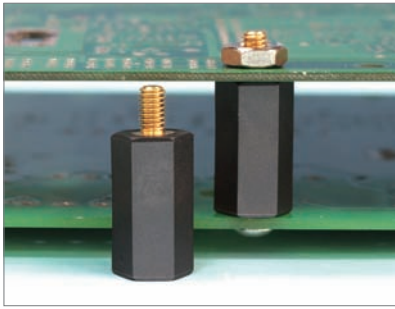

- Material: Nylon 66 (UL)
- Flame Class: 94V-2/94V-0
- Color: Natural/Black
- Unit: mm

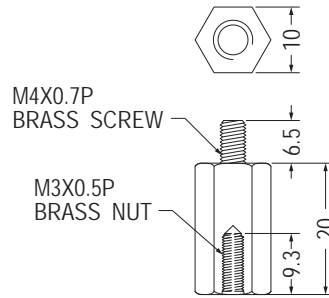

Part No.	Package
MTPA4-3-20	1000

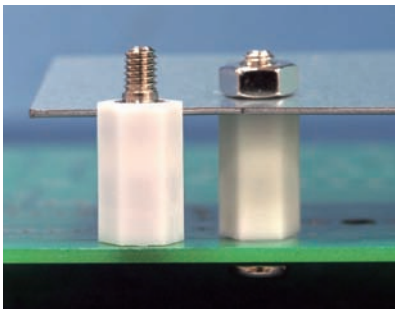

- Material: Nylon 66 (UL)
- Flame Class: 94V-2/94V-0
- Color: Natural/Black
- Unit: mm

用途：做為PC板與機板間之固定，一端配合螺絲，另一端配合螺帽使用。

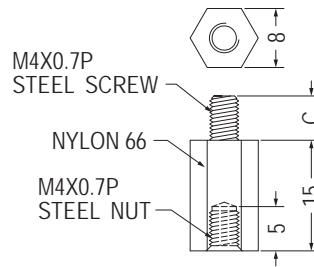

Part No.	C	Package
MTPA4-15-1	6.0	1000
MTPA4-15L	8.0	

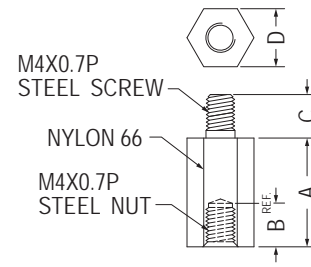

Part No.	A	B	C	D	Package
MTPA4-15	15.0	5.0	6.0	8.0	1000
MTPA4-50L	50.0	6.0	8.0	9.0	200

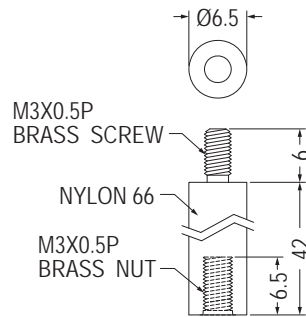
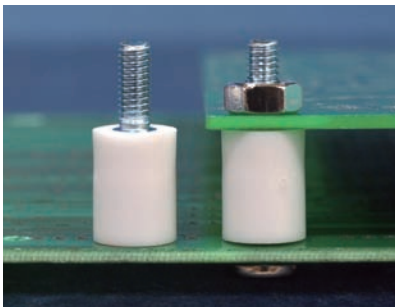

Part No.	Package
MTPG3-42	500

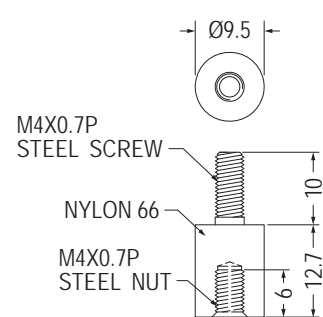

Part No.	Package
MTP4-12.7	1000

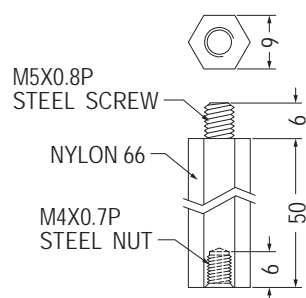
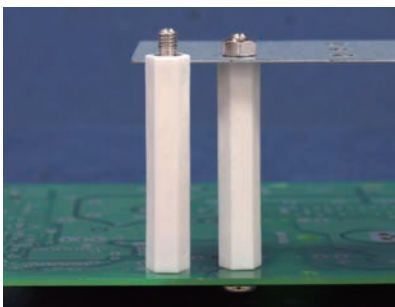

Part No.	Package
MTPA5-4-50	250

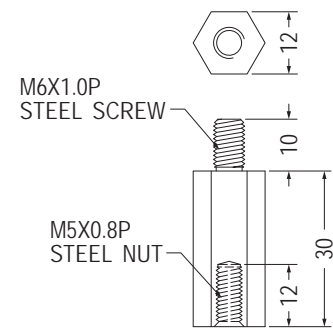

Part No.	Package
MTPA6-5-30	1000

塑膠銅柱 STANDOFF

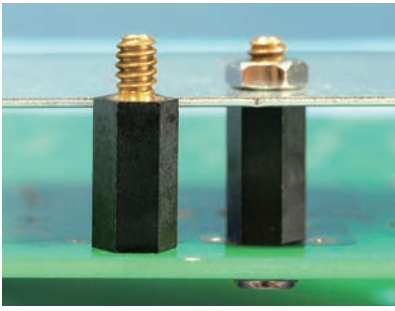

- Material: Nylon 66 (UL)
- Flame Class: 94V-2/94V-0
- Color: Natural/Black
- Unit: mm

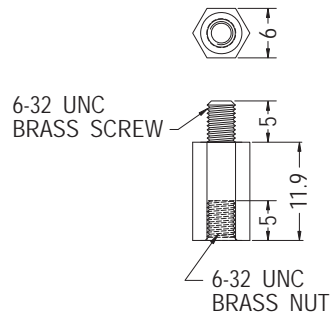

用途：做為PC板與機板間之固定，一端配合螺絲，另一端配合螺帽使用。

Part No.	Package
MTPD632-11.9	1000

1

銅柱 STANDOFF

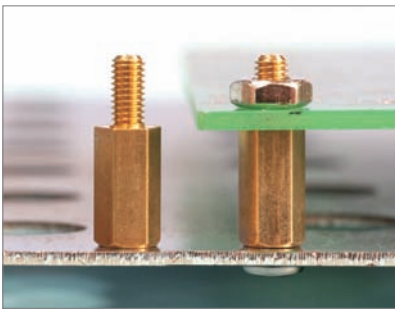

- Material: Brass
- Unit: mm

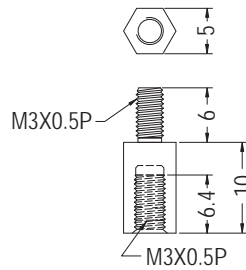

用途：做為PC板與機板間之固定，一端配合螺絲，另一端配合螺帽使用。

Part No.	Package
TP-10BA	1000

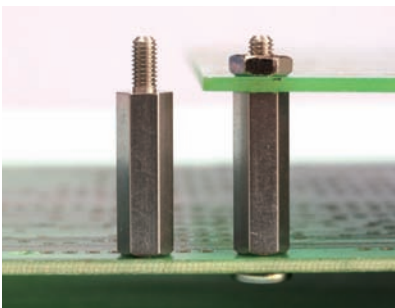

- Material: Steel/SUS
- Unit: mm

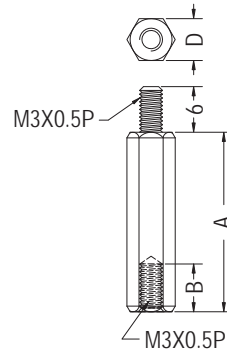

Part No.	A	B	D	Package
TP-18SUS	18.0	8.0	5.5	500
TP-25ST	25.0	6.0	5.0	
TP-30SUS	30.0	6.0	5.0	
TP-55SUS	54.9	8.0	5.5	

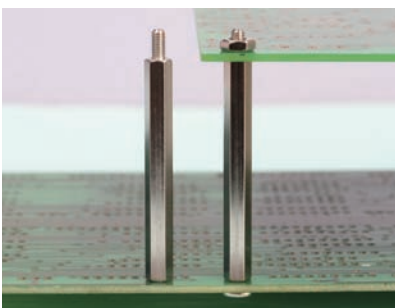

- Material: Steel
- Unit: mm

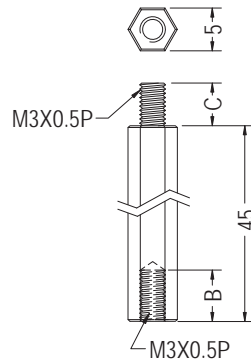

Part No.	B	C	Package
TP3-45ST	5.5	6.0	500
TP3-45LST	6.0	7.0	

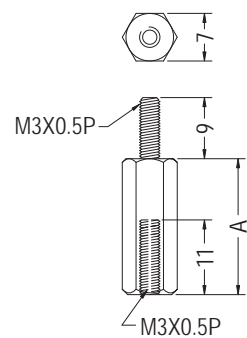

Part No.	A	Package
TPB3-20NI	20.0	500
TPB3-40NI	40.0	

銅柱 STANDOFF

用途：做為PC板與機板間之固定，一端配合螺絲，另一端配合螺帽使用。

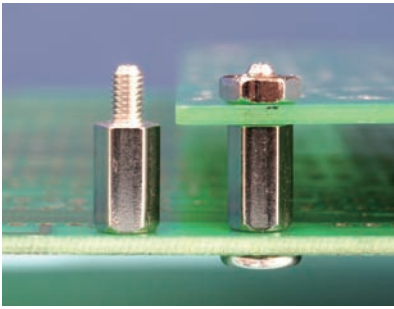

- Material: Steel
- Unit: mm

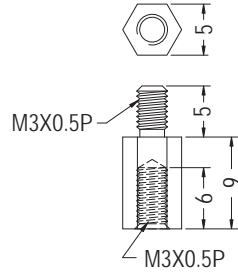

Part No.	Package
TP3-9ST	1000

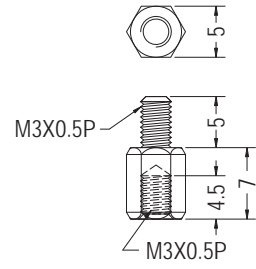

Part No.	Package
TPS3-7ST	1000

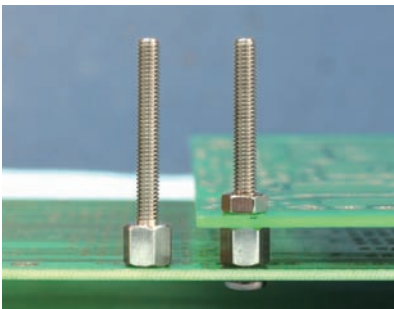

- Material: SUS
- Unit: mm

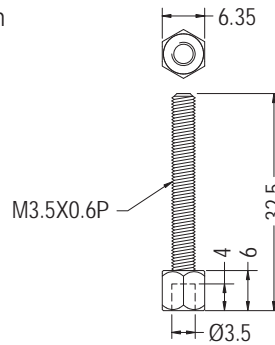

Part No.	Package
TP-6ST	500

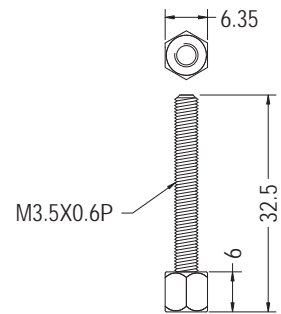

Part No.	Package
TP-6ST-1	500

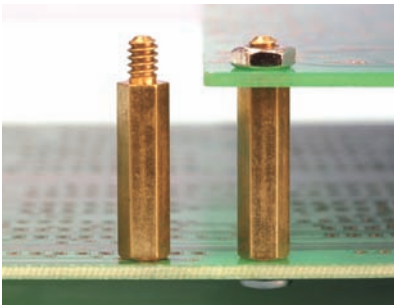

- Material: Brass
- Unit: mm

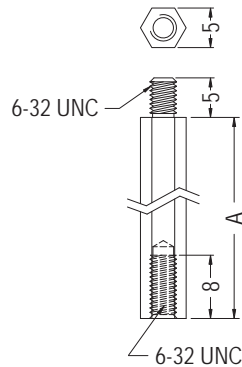

Part No.	A	Package
TP632-19.05BA	19.05	500
TP632-25.4BA	25.4	

塑膠銅柱 STANDOFF

用途：做為PC板與機板間之固定，兩端配合攻牙或螺母使用。

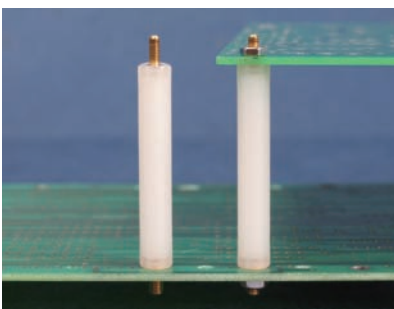

- Material: Nylon 66 (UL)
- Flame Class: 94V-2/94V-0
- Color: Natural/Black
- Unit: mm

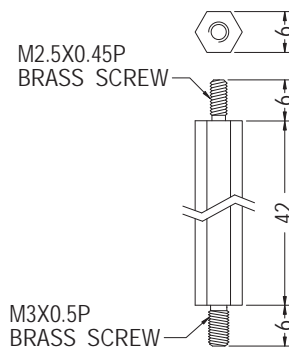

Part No.	Package
TPIM2.5-3-42	500

塑膠銅柱 STANDOFF

用途：做為PC板與機板間之固定，兩端配合攻牙或螺母使用。

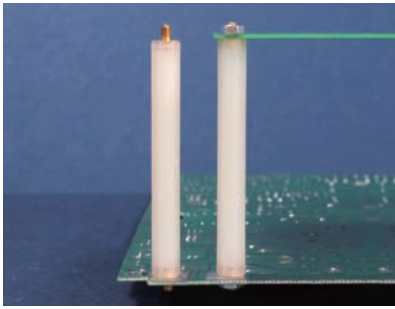

- Material: Nylon 6
- Color: Natural
- Unit: mm

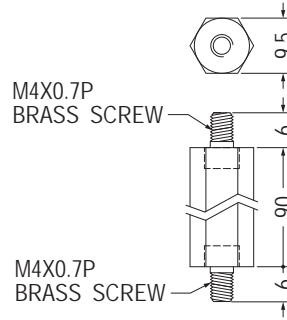

Part No.	Package
TPIM4-90	500

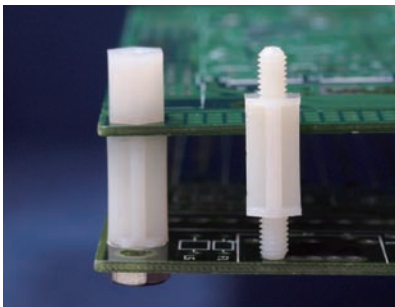

- Material: Nylon 66 (UL)
- Flame Class: 94V-2/94V-0
- Color: Natural/Black
- Unit: mm

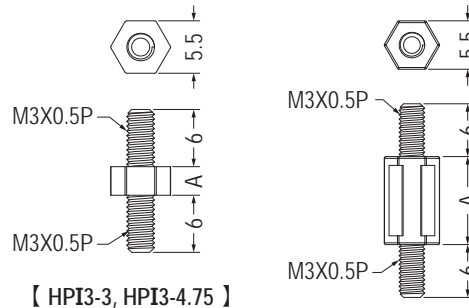

Part No.	A	Package
HPI3-3	3.0	1000
HPI3-4.75	4.75	
HPI3-5	5.0	
HPI3-5.5	5.5	
HPI3-10	10.0	
HPI3-15	15.0	

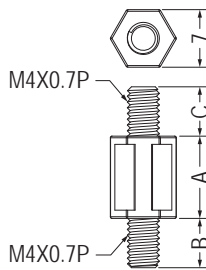

Part No.	A	B	C	Package
HPI4-5	5.0	6.0	6.0	1000
HPI4-10	10.0	6.0	6.0	
HPI4-15	15.0	6.0	6.0	
HPI4-17L	17.0	8.0	8.0	
HPI4-19	19.0	6.0	6.0	
★HPI4-25	25.0	6.0	6.0	

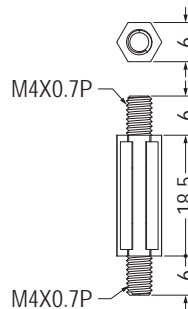

Part No.	Package
HPIB4-18.5	1000

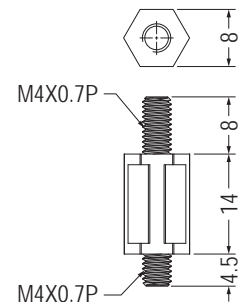

Part No.	Package
HPID4-14	1000

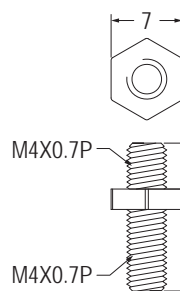
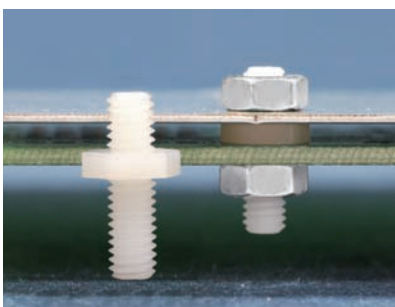

Part No.	Package
HPIA4-2	1000

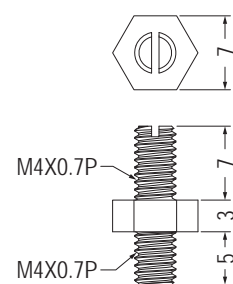

Part No.	Package
HPIE4-3	1000

PC板間隔柱 SPACER SUPPORT

用途：PC板端直接壓入固定，另一端可配合螺母或攻牙。

1

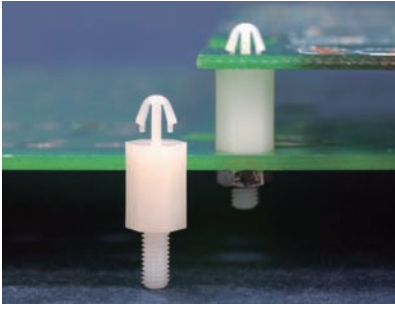

- Material: Nylon 66 (UL)
- Flame Class: 94V-2/94V-0
- Color: Natural/Black
- Unit: mm

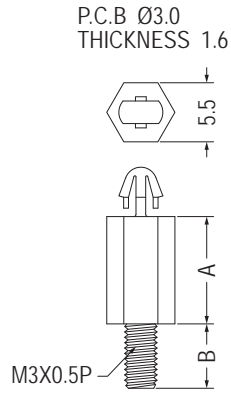

Part No.	A	B	Package
SCBA-3	3.0	6.3	1000
SCBA-3S	3.0	3.0	
SCBA-4	4.0	6.3	
SCBA-5	5.0	6.3	
★SCBA-5S	5.0	4.5	
SCBA-6	6.0	6.3	
SCBA-6S	6.0	4.5	
SCBA-7	7.0	6.3	
SCBA-8	8.0	6.3	
SCBA-9	9.0	6.3	
SCBA-10	10.0	6.3	
SCBA-11	11.0	6.3	
SCBA-12	12.0	6.3	
SCBA-13	13.0	6.3	
SCBA-14	14.0	6.3	
SCBA-15	15.0	6.3	
SCBA-16	16.0	6.3	

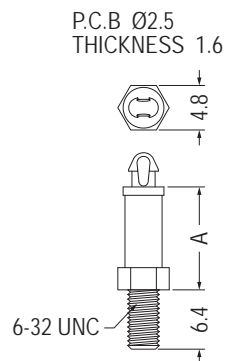
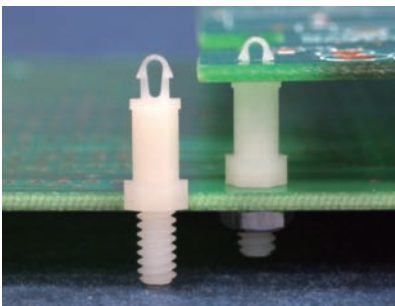
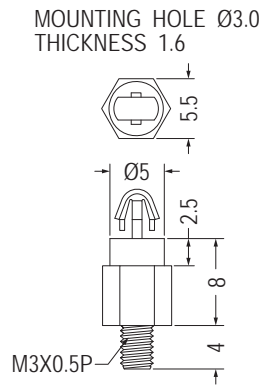
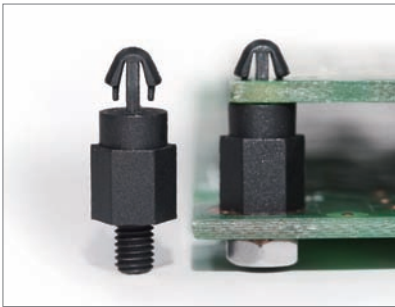
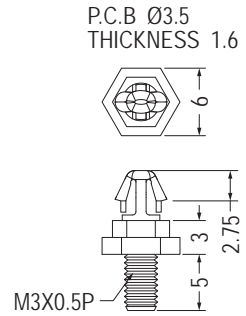
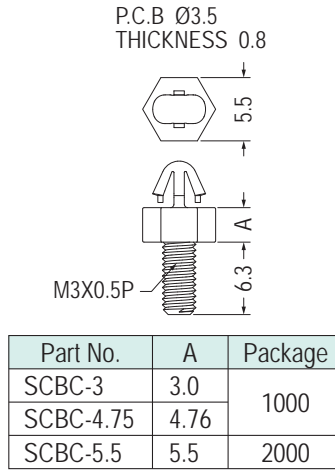
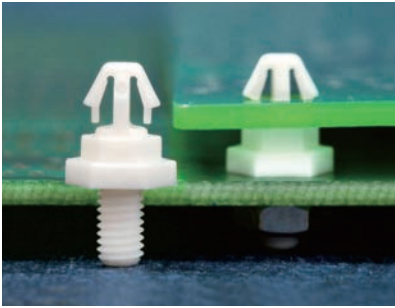

Part No.	A	Package
SCBS632-3.2	3.2	1000
SCBS632-4.8	4.8	
SCBS632-6.4	6.4	
SCBS632-7.9	7.9	
SCBS632-9.5	9.5	
SCBS632-11.1	11.1	
SCBS632-12.7	12.7	
SCBS632-14.3	14.3	
SCBS632-15.9	15.9	

PC板間隔柱 SPACER SUPPORT

用途：PC板端直接壓入固定，另一端可配合螺母或攻牙。

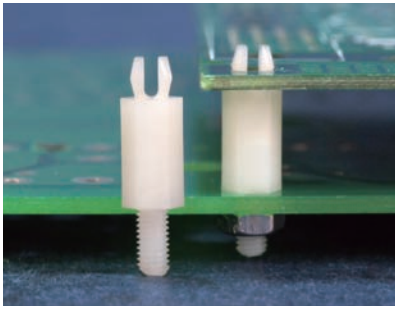

- Material: Nylon 66 (UL)
- Flame Class: 94V-2/94V-0
- Color: Natural/Black
- Unit: mm

MOUNTING HOLE $\varnothing 3.9\text{--}\varnothing 4.0$
THICKNESS 1.6

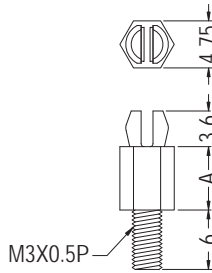

MOUNTING HOLE $\varnothing 3.9\text{--}\varnothing 4.0$
THICKNESS 1.6

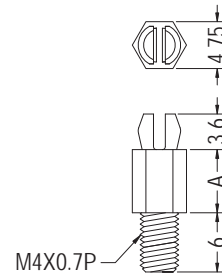

MOUNTING HOLE $\varnothing 3.0$
THICKNESS 1.2

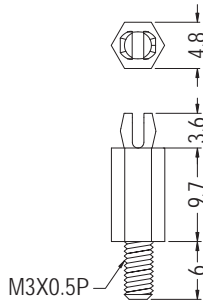

Part No.	Package
MSPA3-9.7	1000

Part No.	A	Package
MSPG3-3.2	3.2	1000
MSPG3-4.8	4.8	
MSPG3-6.4	6.4	
MSPG3-9.5	9.5	
MSPG3-12.7	12.7	
MSPG3-15.9	15.9	
MSPG3-19.1	19.1	
MSPG3-22.2	22.2	

Part No.	A	Package
MSPG4-3.2	3.2	1000
MSPG4-4.8	4.8	
MSPG4-6.4	6.4	
MSPG4-9.5	9.5	
MSPG4-12.7	12.7	
MSPG4-15.9	15.9	
MSPG4-19.1	19.1	
MSPG4-22.2	22.2	

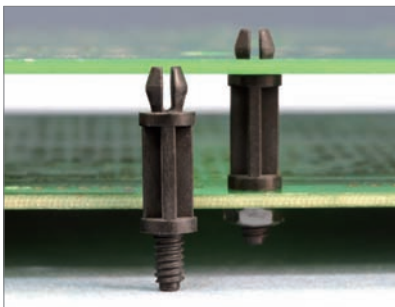

MOUNTING HOLE: $\varnothing G$
THICKNESS 2.1

MOUNTING HOLE: $\varnothing G$
THICKNESS 1.6

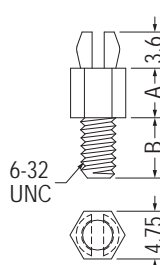
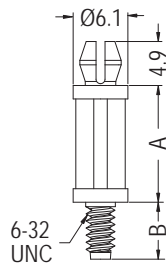

【 MSPS-13 】

Part No.	A	B	G	Package
MSPS-2S	2.0	3.0	4.0	2000
MSPS-3	3.2	6.0	4.0	
MSPS-5	4.8	6.0	3.9-4.0	1000
MSPS-6	6.4	6.0	3.9-4.0	
MSPS-12.7	12.7	6.0	3.9-4.0	
MSPS-13	13.0	6.35	4.0	
MSPS-15.9	15.9	6.0	3.9-4.0	
MSPS-19.1	19.1	6.0	3.9-4.0	
MSPS-22.2	22.2	6.0	3.9-4.0	

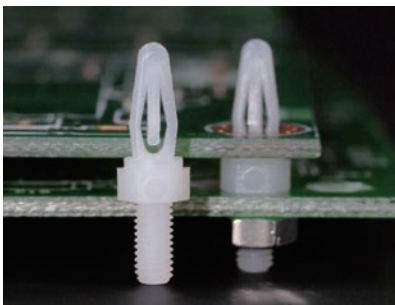

MOUNTING HOLE $\varnothing 3.2$
THICKNESS 1.6

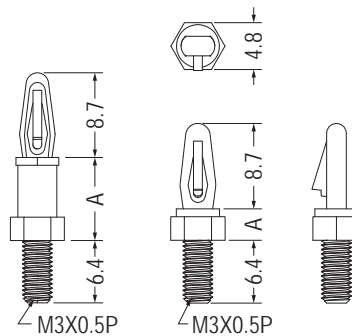

MOUNTING HOLE $\varnothing 3.4$
THICKNESS 1.6

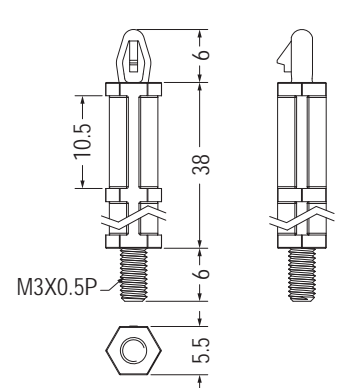

【 SCB3-12.7 】

Part No.	A	Package
SCB3-3.2	3.2	1000
SCB3-9.5	9.5	
SCB3-12.7	12.7	

Part No.	Package
SCB3-38	1000



PC板間隔柱 SPACER SUPPORT

用途：PC板端直接壓入固定，另一端可配合螺母或攻牙。

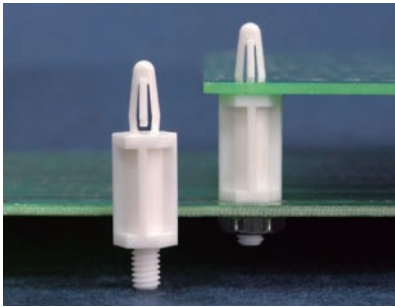

- Material: Nylon 66 (UL)
- Flame Class: 94V-2/94V-0
- Color: Natural/Black
- Unit: mm

MOUNTING HOLE Ø4.0
THICKNESS 1.6

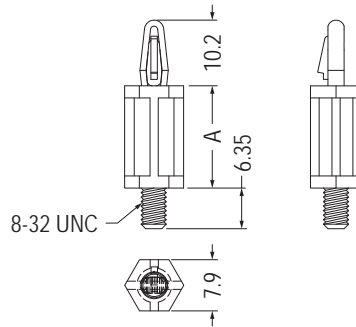

Part No.	A	Package
SCB832-6.35	6.35	1000
SCB832-12.7	12.7	
SCB832-15.9	15.9	
★SCB832-19	19.05	

MOUNTING HOLE Ø4.0
THICKNESS 1.6

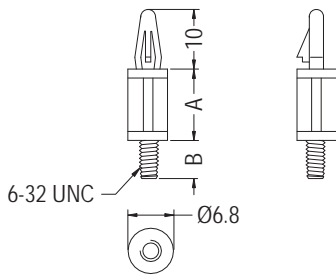

Part No.	A	B	Package
SCB-6	6.3	7.8	1000
SCB-10	9.5	7.8	
SCB-12	12.7	7.8	
SCB-15	15.9	7.8	
SCB-15A	15.9	4.8	

MOUNTING HOLE Ø4.0
THICKNESS 1.6

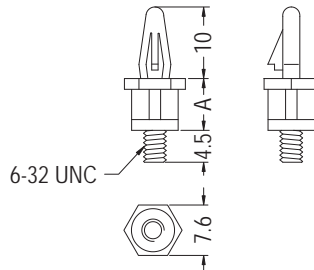

Part No.	A	Package
SCB-8.5S	8.5	1000
SCB-10SA	10.0	
SCB-10SA	10.0	

MOUNTING HOLE Ø4.0
THICKNESS 1.2-1.7

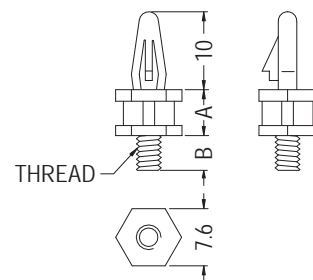

Part No.	A	B	Thread	Package
SCB-6SM3	6.3	4.8	M3X0.5P	1000
SCB-6S	6.3	4.8	6-32 UNC	
SCB-8S	8.0	4.5	6-32 UNC	
SCB-10S	10.0	4.5	6-32 UNC	
SCB-10S	10.0	4.5	6-32 UNC	

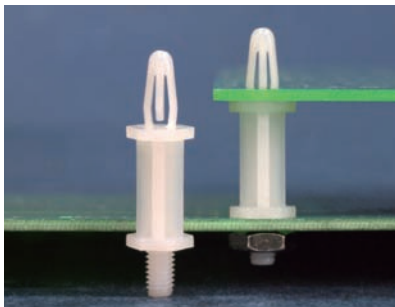

MOUNTING HOLE Ø4.0
THICKNESS: T

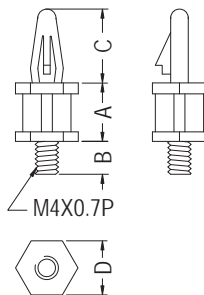

Part No.	A	B	C	D	T	Package
SCB4-6	6.3	4.8	10.7	7.6	1.2-1.7	1000
SCB4-6A	6.3	6.4	10.7	7.6	1.2-1.7	
SCB4-9.5	9.5	6.4	10.2	7.7	1.6	
SCB4-16	15.9	6.4	10.0	8.0	1.6-1.8	

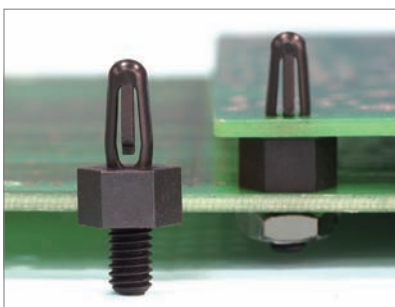

MOUNTING HOLE Ø4.0
THICKNESS: T

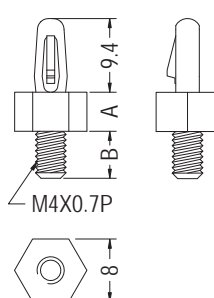

Part No.	A	B	T	Package
SCB4-4	4.0	6.4	2.0	1000
SCB4-5	5.0	6.0	1.6	

MOUNTING HOLE Ø4.0
THICKNESS 1.6

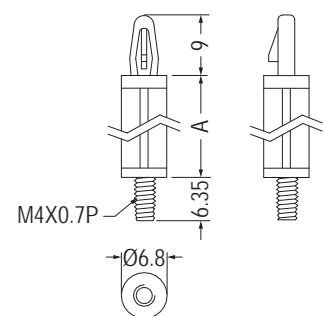

Part No.	A	Package
SCB4-23.8	23.8	1000
SCB4-30	30.0	

PC板間隔柱 SPACER SUPPORT

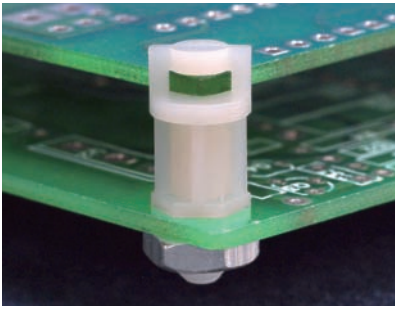

- Material: Nylon 66 (UL)
- Flame Class: 94V-2/94V-0
- Color: Natural/Black
- Unit: mm

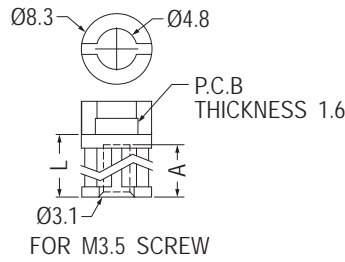

用途：PC板端直接壓入固定，另一端可配合螺母或攻牙。

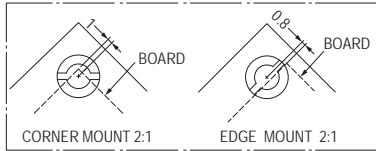
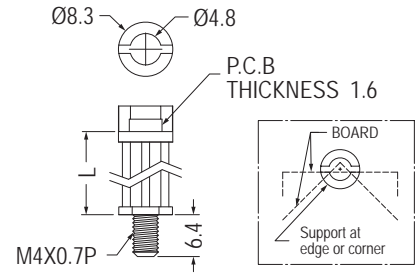

Part No.	A	L	Package
TCEH-6.4	5.2	6.4	1000
TCEH-9.5	7.9	9.5	
TCEH-12.7	7.9	12.7	
TCEH-15.9	7.9	15.9	

Part No.	L	Package
TCEP4-6.4	6.4	1000
TCEP4-9.5	9.5	
TCEP4-12.7	12.7	
TCEP4-15.9	15.9	

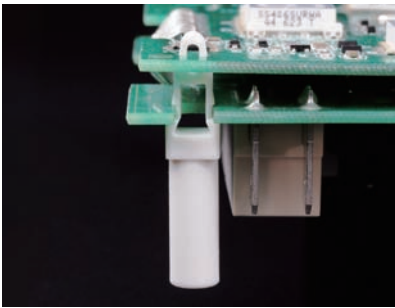

- Material: PBT (UL)+GF
- Flame Class: 94V-0
- Color: Natural
- Unit: mm

MOUNTING HOLE Ø3.7 THICKNESS 1.6
MOUNTING HOLE Ø5.7 THICKNESS 1.6

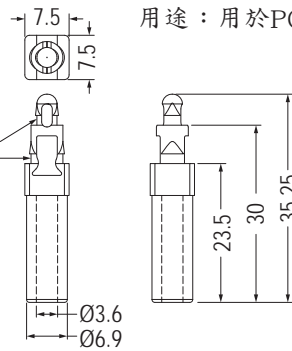

用途：用於PC板之間隔柱。



Part No.	Package
THCS-2	1000

觸控間隔柱 TOUCH CONTROL SPACER

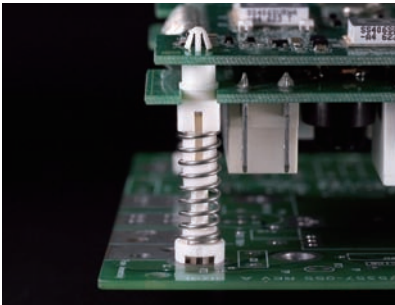

- Material: Nylon 66 (UL)
- Flame Class: 94V-0
- Spring Material: SUS
- Color: Natural
- Unit: mm
- Patented (專利品)

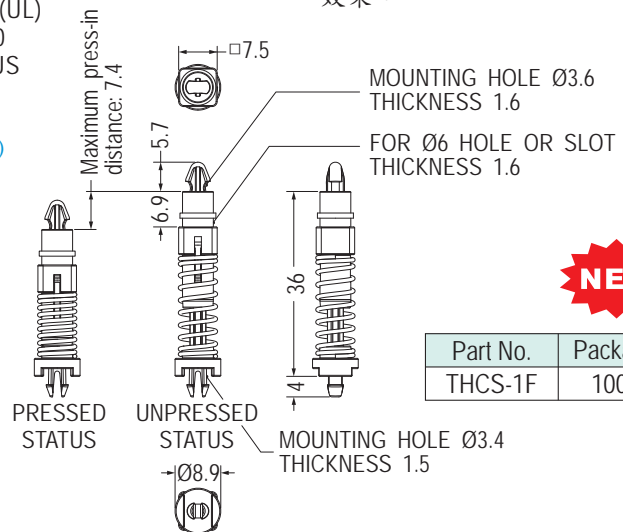

用途：固定觸控面板於機板上，具減震效果。



Part No.	Package
THCS-1F	1000

導電間隔柱 SPACER SUPPORT

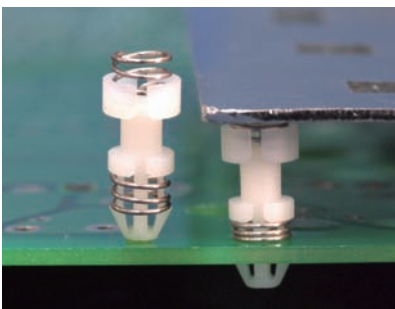

- Material: Nylon 66 (UL)
- Flame Class: 94V-2/94V-0
- Color: Natural/Black
- Unit: mm
- USA Patented (美國專利品)

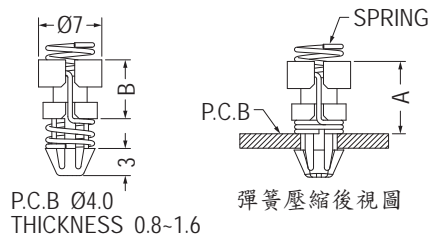

用途：支撐PC板與機板間之導電。

Part No.	A	B	Package
ALUCA-8	8.0	6.5	1000
ALUCA-9	9.0	7.5	
ALUCA-10	10.0	8.5	
ALUCA-12	12.0	10.5	
ALUCA-14	14.0	12.5	
ALUCA-16	16.0	14.5	

導光板間隔柱 PILLAR SUPPORT

用途：用於支撐液晶面板，高導光，高反射，高透光。

- Material: PC (UL)
- Flame Class: 94V-2/94V-0
- Color: Natural/Transparent
- Unit: mm

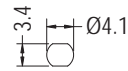
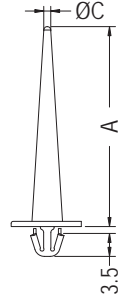
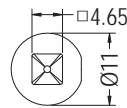
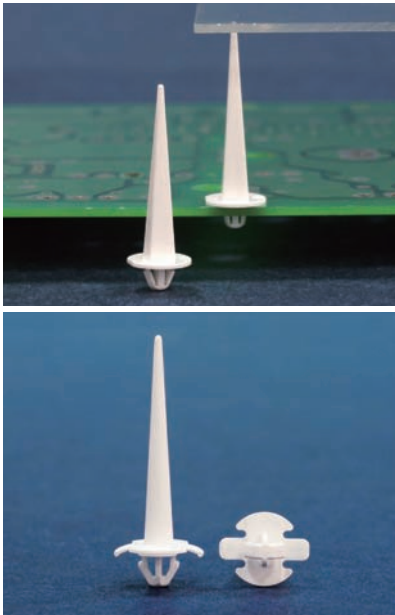

MOUNTING HOLE THICKNESS: T

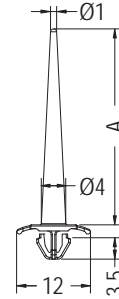
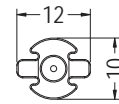

P.C.B Ø4.5 THICKNESS 0.8-1.0

Part No.	A	C	T	Package
MCFG-3010	30.5	0.8	1.0	1000
MCFG-35810	35.8	1.05	1.05	

Part No.	A	Package
MCFD-2810	28.0	1000
MCFD-3210	32.0	

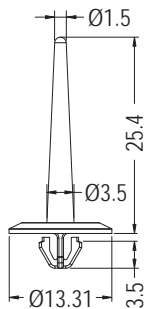

P.C.B Ø4.5 THICKNESS: T

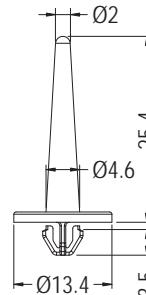

P.C.B Ø4.5 THICKNESS 0.6-0.8



P.C.B Ø4.5 THICKNESS 1.0

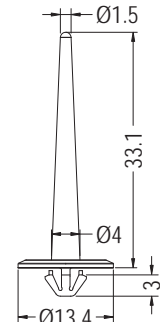

MOUNTING HOLE Ø4.6 THICKNESS: T

Part No.	T	Package
MCFA-2508	0.6-0.8	500
MCFA-2511	0.8-1.1	

Part No.	Package
MCFC-2508	1000

Part No.	Package
MCFL-3310	1000

Part No.	T	Package
MCF-3305	0.6	500
MCF-3308	0.5-0.8	

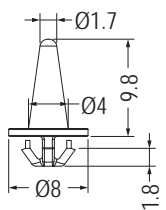

MOUNTING HOLE Ø4.6 THICKNESS 1.0

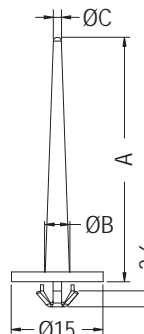

MOUNTING HOLE Ø5.2 THICKNESS: T

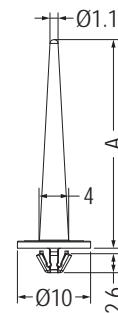

MOUNTING HOLE Ø3.8 THICKNESS: T

Part No.	Package
★MCFF-25	1000

Part No.	A	B	C	T	Package
MCF-2310	23.5	4.5	1.6	0.8-1.0	500
MCF-4213	40.0	3.95	1.3	1.0-1.3	

Part No.	A	T	Package
MCFO-2806	28.5	0.5-0.65	1000
MCFO-2906	29.5	0.5-0.65	
MCFO-2908	29.5	0.6-0.8	

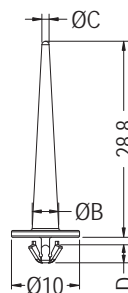
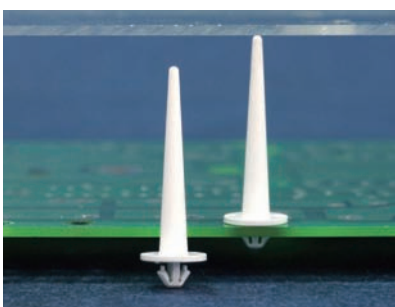

MOUNTING HOLE: ØG THICKNESS: T

Part No.	B	C	D	G	T	Package
MCFJ-4	3.9	1.06	2.65	3.8	1.0	1000
MCFJ-6	4.3	1.5	2.65	3.8	1.25	
MCFJ-7	3.9	1.06	2.5	3.5	0.8	

導光板間隔柱 PILLAR SUPPORT

用途：用於支撐液晶面板，高導光，高反射，高透光。

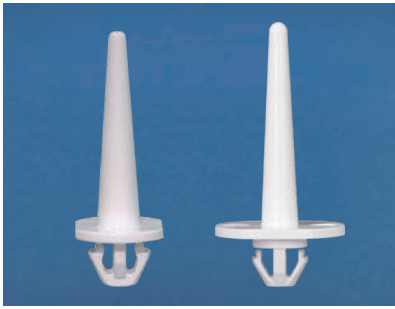

- Material: PC (UL)
- Flame Class: 94V-0
- Color: Natural
- Unit: mm

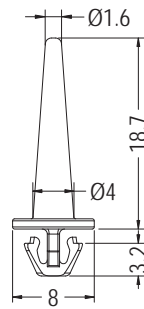

MOUNTING HOLE Ø4.6
THICKNESS 1.3

Part No.	Package
MCFF-20	1000

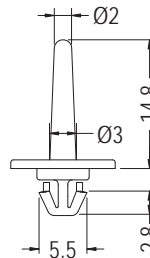

MOUNTING HOLE Ø4.5
THICKNESS 1.2

Part No.	Package
MCFF-18	1000

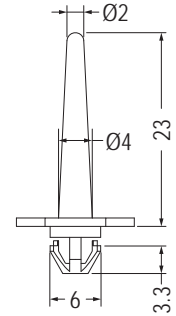

MOUNTING HOLE Ø5.5
THICKNESS 0.8

Part No.	Package
MCFF-21	1000

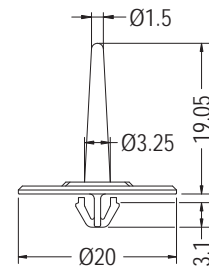
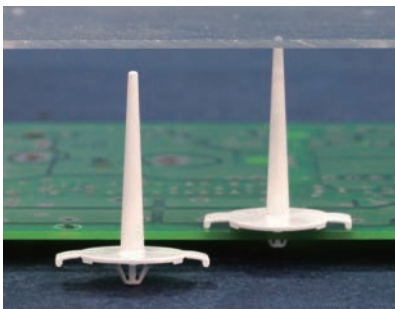

MOUNTING HOLE Ø4.7
THICKNESS 1.0

Part No.	Package
MCFF-11	1000

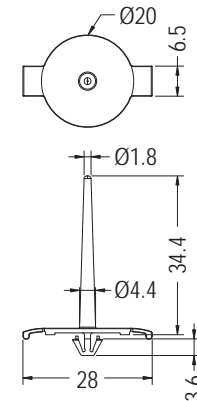

P.C.B Ø5.0
THICKNESS 0.75-1.05

Part No.	Package
MCFD-1	500

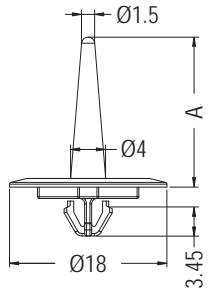
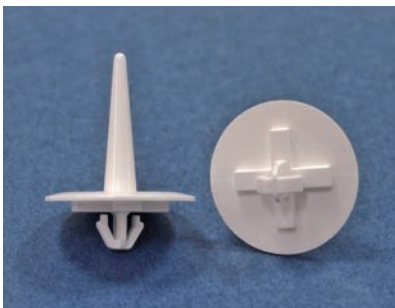

P.C.B Ø4.6
THICKNESS: T

Part No.	A	T	Package
MCFF-9	17.16	0.6-0.8	1000
MCFF-10	31.42	0.8	500
MCFF-14	18.0	0.8	1000



- Material: Nylon 66 (UL)
- Flame Class: 94V-0
- Color: White
- Unit: mm

- Material: PC (UL)
- Flame Class: 94V-2/94V-0
- Color: Transparent
- Unit: mm

- Material: PC (UL)
- Flame Class: 94V-2/94V-0
- Color: Natural/Transparent
- Unit: mm

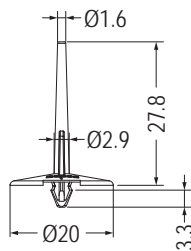

P.C.B Ø3.0
THICKNESS 0.65

Part No.	Package
MCFM-2807	1000

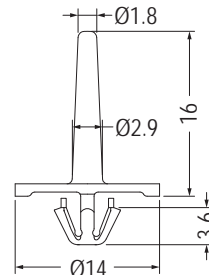

HOLE IN CHASSIS Ø5.0
THICKNESS 1.0

Part No.	Package
MCFF-24	1000

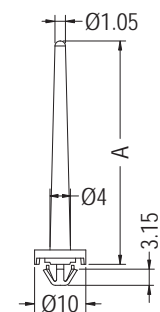

P.C.B Ø5.2
THICKNESS 0.6-0.8

Part No.	A	Package
MCF-428	42.6	500
MCF-2908	29.0	500

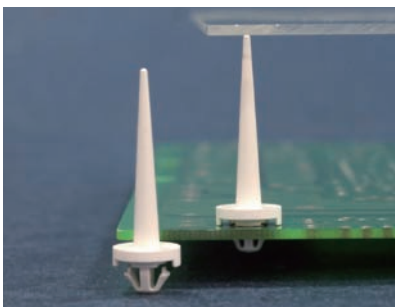

導光板間隔柱 PILLAR SUPPORT

用途：用於支撐液晶面板，高導光，高反射，高透光。

1

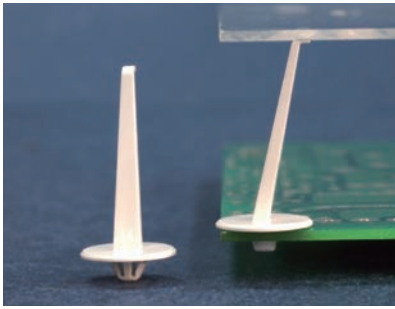

- Material: PC (UL)
- Flame Class: 94V-2/94V-0
- Color: Natural/Transparent
- Unit: mm

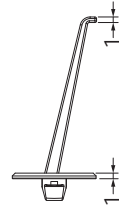
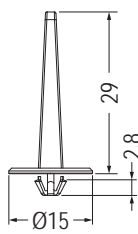

MOUNTING HOLE Ø4.5
THICKNESS 0.8-1.0

Part No.	Package
MCF-1	1000

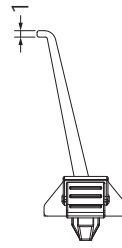
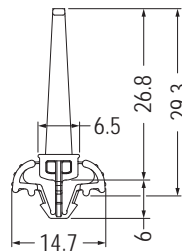
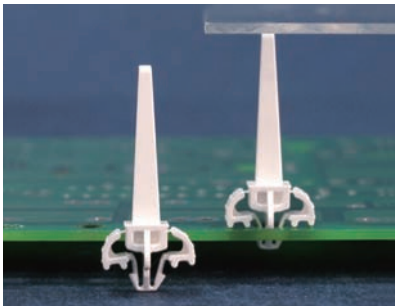

MOUNTING HOLE Ø4.5
THICKNESS 1.0

• Patented (專利品)

Part No.	Package
MCFF-5	1000

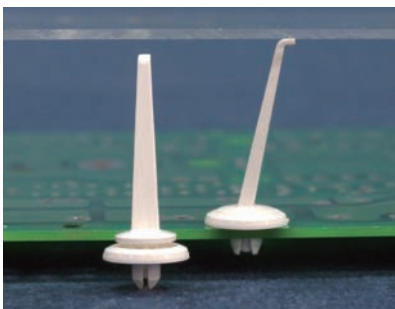

- Material: PC (UL)
- Flame Class: 94V-0
- Color: Natural
- Unit: mm
- Patented (專利品)

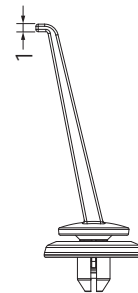
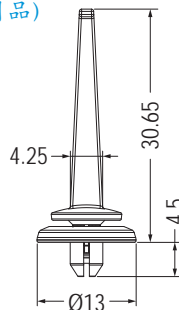

MOUNTING HOLE Ø4.5
THICKNESS 1.0-1.2

Part No.	Package
MCFF-6	500

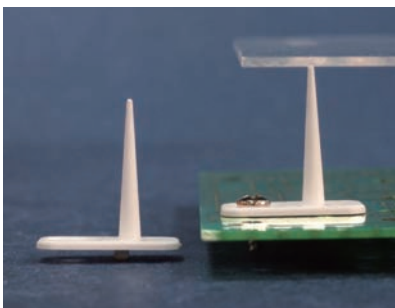

- Material: PC (UL)
- Flame Class: 94V-0
- Color: White
- Unit: mm

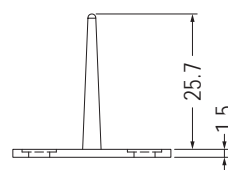
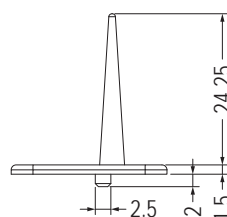
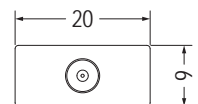
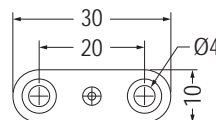
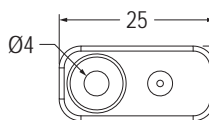

MOUNTING HOLE Ø5.0
THICKNESS 0.6-0.8

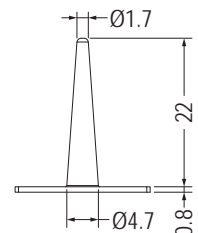

Part No.	Package
MCFJ-1	1000

Part No.	Package
MCFJ-2	1000

Part No.	Package
★MCFP-33	1000

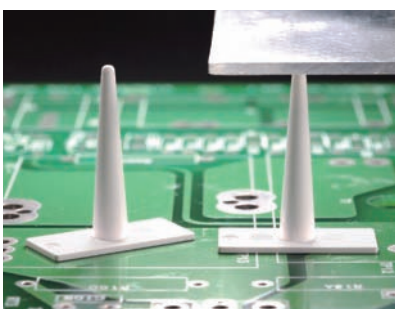

導光板間隔柱 PILLAR SUPPORT

用途：用於支撐液晶面板，高導光，高反射，高透光。

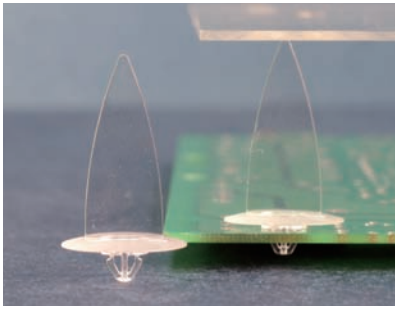

- Material: PC (UL)
- Flame Class: 94V-2/94V-0
- Color: Transparent
- Unit: mm

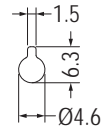
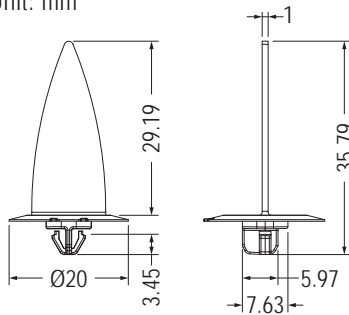

MOUNTING HOLE THICKNESS 0.8

Part No.	Package
MCFF-15	1000

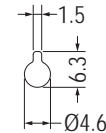
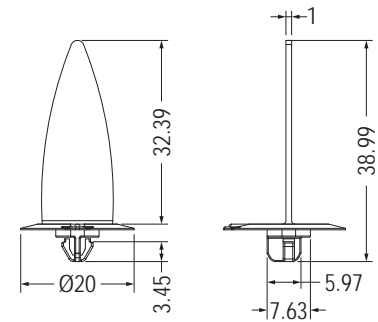

MOUNTING HOLE THICKNESS 0.8

Part No.	Package
MCFF-16	1000

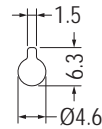
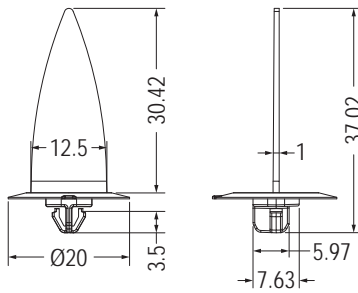
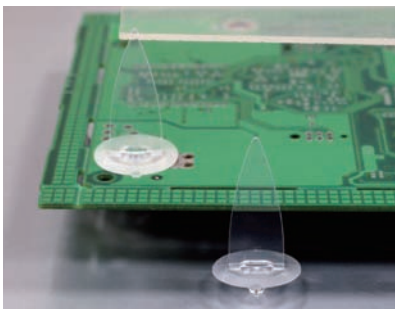

MOUNTING HOLE THICKNESS 0.8

Part No.	Package
MCFF-13	1000

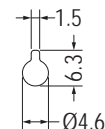
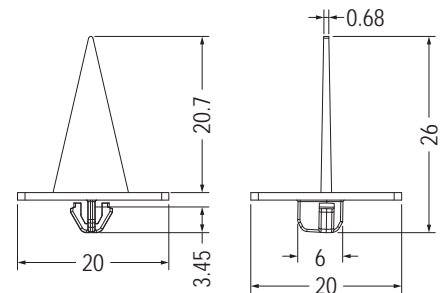

MOUNTING HOLE THICKNESS 0.8

Part No.	Package
MCFF-17	1000

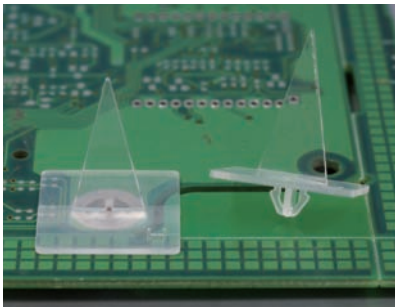

- Material: PC (UL)/94V-0
- Color: Transparent
- Base Material: Nylon 66 (UL)/94V-0
- Base Color: Natural
- Unit: mm
- Patented (專利品)

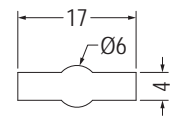
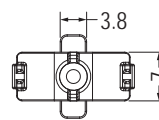

MOUNTING HOLE THICKNESS 0.5-1.0

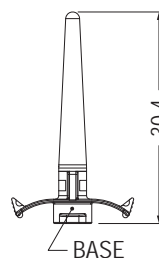

Part No.	Package
MCFF-7	1000

導光板間隔柱 PILLAR SUPPORT

用途：用於支撐液晶面板，高導光，高反射，高透光。

1

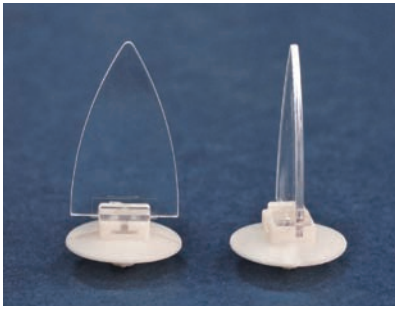

- Material1: PC (UL)
- Material2: Nylon 66 (UL)
- Flame Class: 94V-2/94V-0
- Color1: Transparent
- Color2: Natural/White
- Unit: mm
- Patented (專利品)

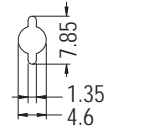
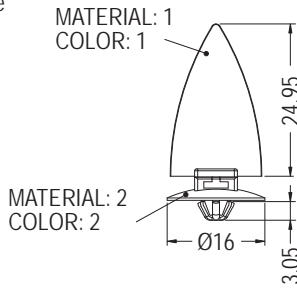

MOUNTING HOLE THICKNESS 0.8-1.0

Part No.	Package
MCFF-12	1000

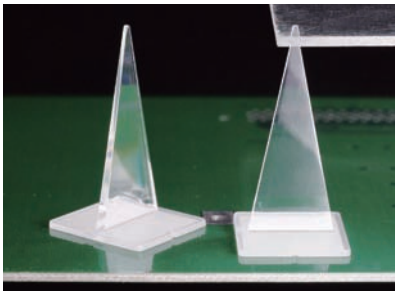

- Material: PC (UL)
- Flame Class: 94V-2/94V-0
- Color: Transparent
- Unit: mm

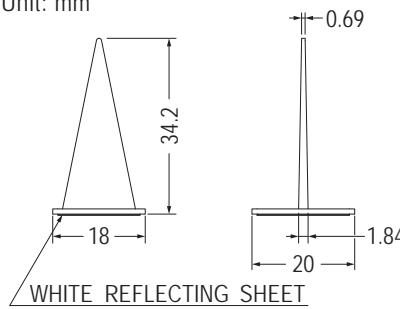

Part No.	Package
★MCFP-30	1000

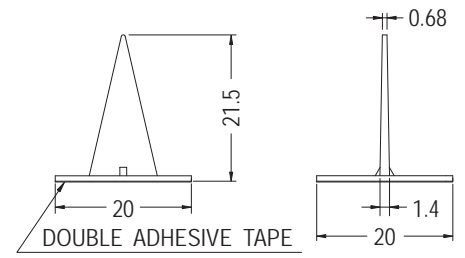

Part No.	Package
MCFP-5	1000

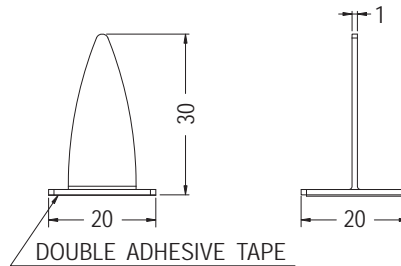
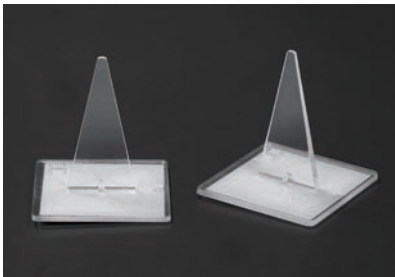

Part No.	Package
MCFP-7	1000

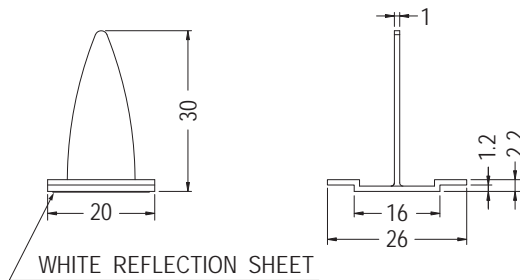
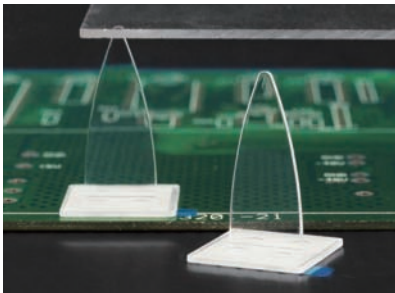

Part No.	Package
MCFP-9	1000

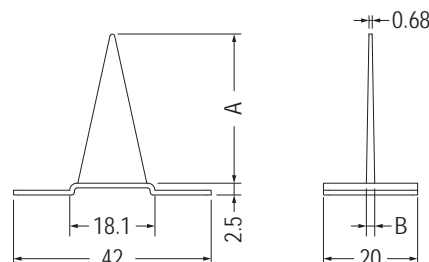
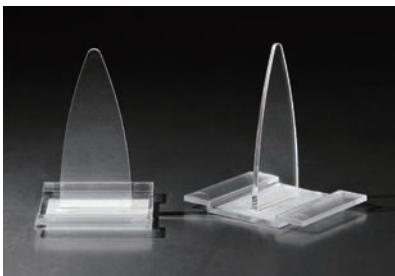

Part No.	A	B	Package
MCFP-31	31.7	1.78	500
MCFP-32	32.0	1.8	

NEW

導光板間隔柱 PILLAR SUPPORT

用途：用於支撐液晶面板，高導光，高反射，高透光。

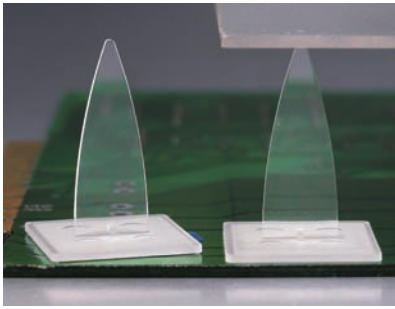

- Material: PC (UL)
- Flame Class: 94V-2/94V-0
- Color: Transparent
- Unit: mm

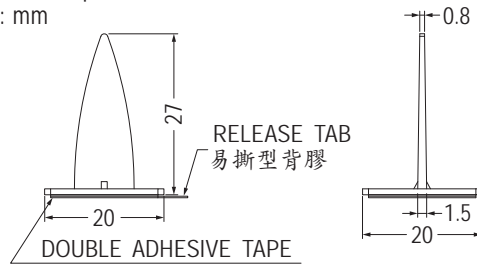

Part No.	Package
MCFP-18	1000

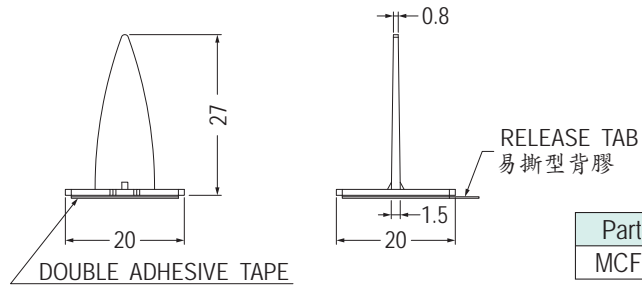
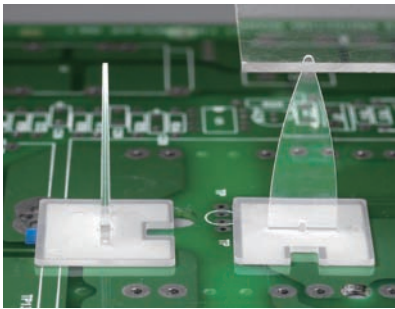

NEW

Part No.	Package
MCFP-29	1000

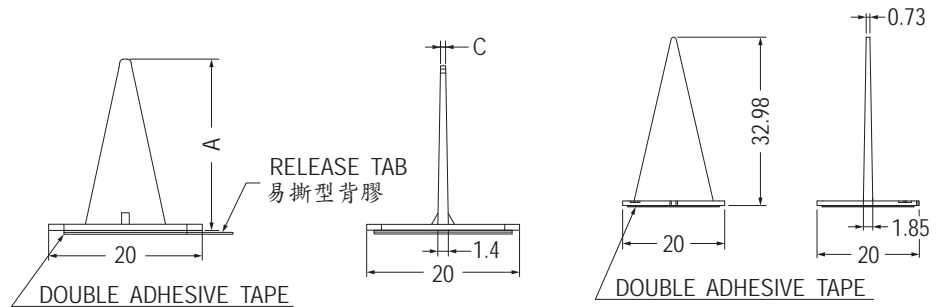
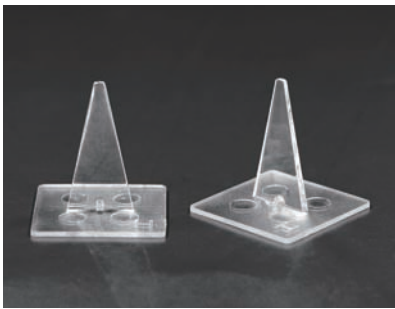

Part No.	A	C	Package
MCFP-12	20.7	0.71	1000
MCFP-25	22.3	0.68	

Part No.	Package
MCFP-17-1	1000

PC板間隔柱 SPACER SUPPORT

用途：適用於NGFF卡於機板上，免工具，易拆卸。



- Material: Nylon 66 (UL)
- Flame Class: 94V-2/94V-0
- Color: Natural/Black/Green/Blue
- Unit: mm

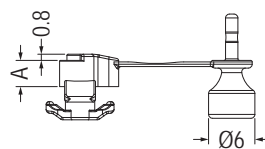

【 ULCN3.4-2.1 】

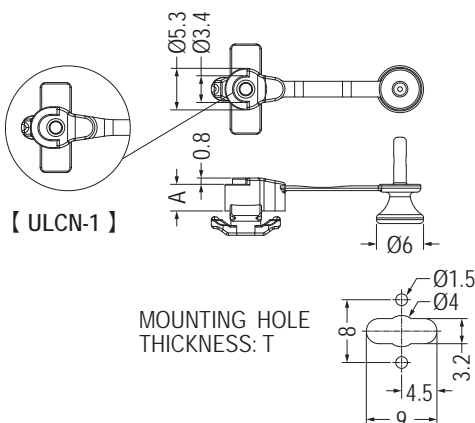
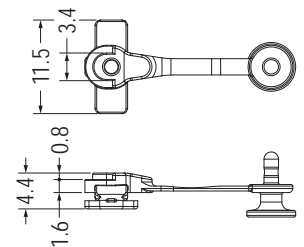

【 ULCN-1 】

MOUNTING HOLE THICKNESS: T

Part No.	A	T	Package
ULCN-1	1.7	2.1~2.4	1000
ULCN1.7-2.4	1.7	2.1~2.4	
ULCN2.2-1.2	2.2	1.2	
ULCN2.5-1.6	2.5	0.8~1.6	
ULCN2.5-2.6	2.5	1.8~2.6	
ULCN2.5-2.9	2.5	2.1~2.9	
ULCN3.4-0.8	3.4	0.8	
ULCN3.4-2.1	3.4	2.13	
ULCN6.3-1.6	6.3	1.6	

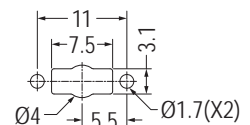

MOUNTING HOLE THICKNESS 0.6

- Flame Class: 94V-2
- Color: Green

Part No.	Package
ULCN-3	1000

PC板間隔柱 SPACER SUPPORT

用途：適用於NGFF卡於機板上，免工具，易拆卸。

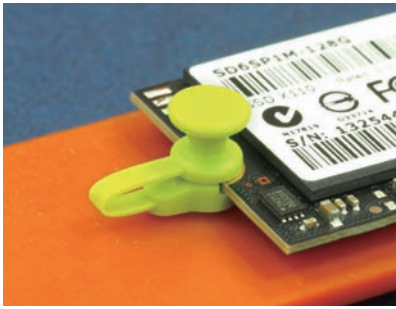

- Material: Nylon 66 (UL)
- Flame Class: 94V-2/94V-0
- Color: Natural/Black/Green/Blue
- Unit: mm
- Patented (專利品)

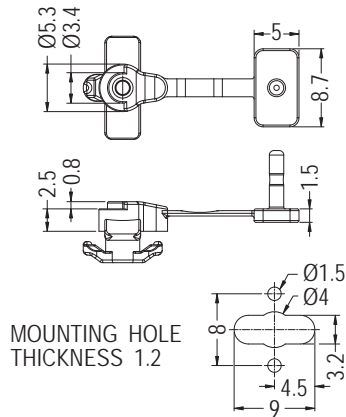

Part No.	Package
ULCN2.5-1.2	1000

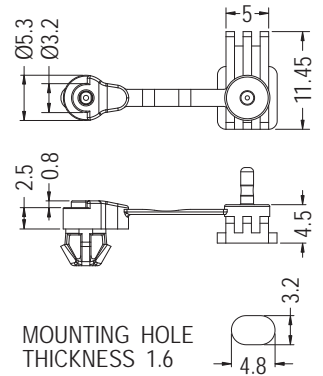

Part No.	Package
ULCW2.5-1.6	1000

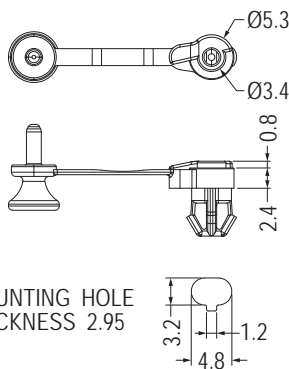

Part No.	Package
★ULCO2.4A-3.1	1000

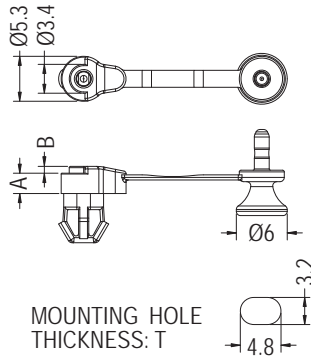

Part No.	A	B	T	Package
ULCO2.1-2	2.08	0.81	2.0	1000
ULCO2.4-2.1	2.4	0.8	2.1	
ULCO2.4-3.1	2.4	0.8	2.95	
ULCO2.5-1.6	2.5	0.8	1.6	
ULCO2.5-2.2	2.5	0.8	2.2	
ULCO2.5-2.4	2.5	0.8	2.4	
ULCO2.5-4.2	2.5	0.8	4.2	
ULCO6.6-2.6	6.6	0.8	2.46	

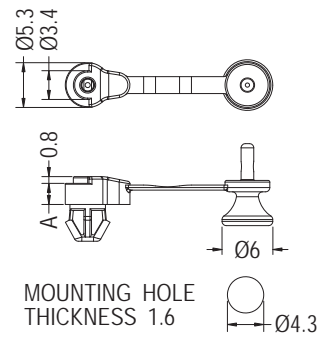

Part No.	A	Package
ULCOG2.5-1.6	2.5	1000
ULCOG6.3-1.6	6.3	

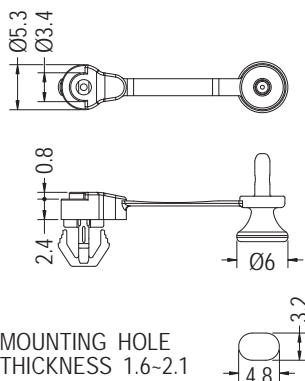

Part No.	Package
ULCOJ-1	1000

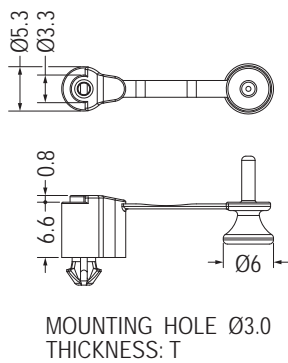

Part No.	T	Package
★ULCN6.6-1.2	1.2	1000
★ULCN6.6-1.6	1.5~1.6	

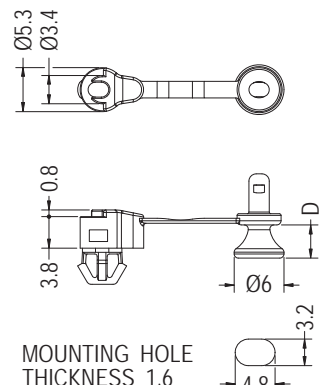

Part No.	D	Package
ULCO3.8-1.6S	2.5	1000
ULCO3.8-1.6	4.0	

PC板間隔柱 SPACER SUPPORT

用途：適用於NGFF卡於機板上，免工具，易拆卸。

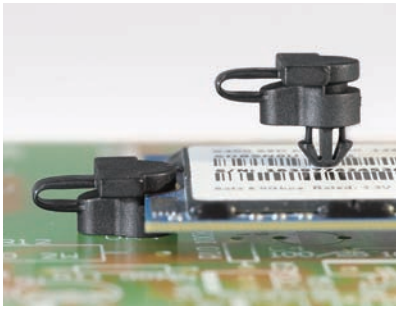

- Material: Nylon 66 (UL)
- Flame Class: 94V-2/94V-0
- Color: Natural/Black/Green/Blue
- Unit: mm
- Patented (專利品)

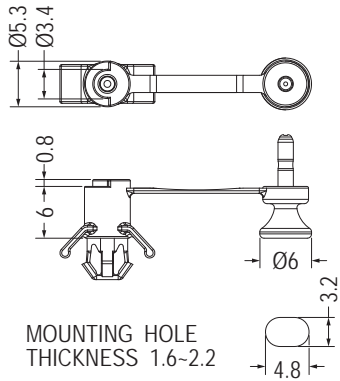

MOUNTING HOLE THICKNESS 1.6-2.2

Part No.	Package
ULCOB-1	1000

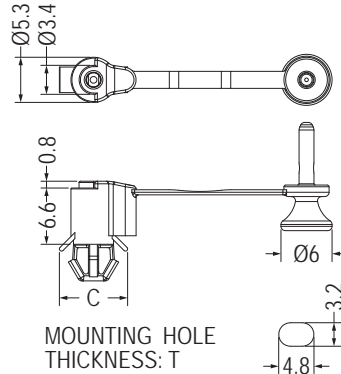

MOUNTING HOLE THICKNESS: T

Part No.	C	T	Package
ULCO6.6-1.6	8.0	1.6	1000
ULCO6.6-2	8.0	1.9-2.1	
ULCO6.6-3.1	8.3	2.7-3.3	

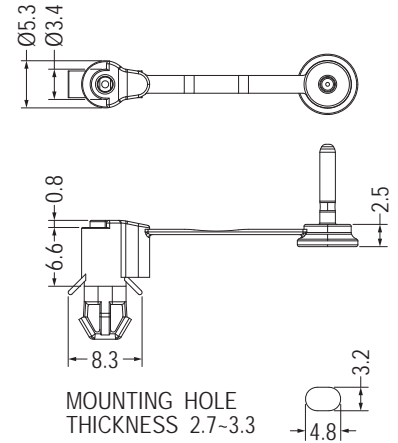

MOUNTING HOLE THICKNESS 2.7-3.3

Part No.	Package
ULCO6.6-3.1S	1000

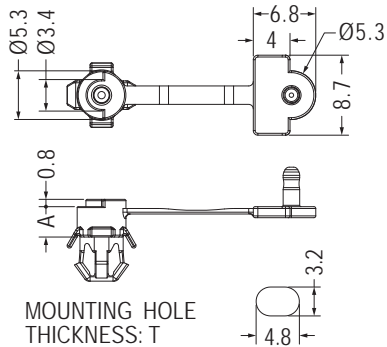

MOUNTING HOLE THICKNESS: T

Part No.	A	T	Package
ULCOB3.3-2.3	3.3	2.27	1000
★ULCOB6-1.6	6.0	1.6	
ULCOB6-2.3	6.0	2.27	

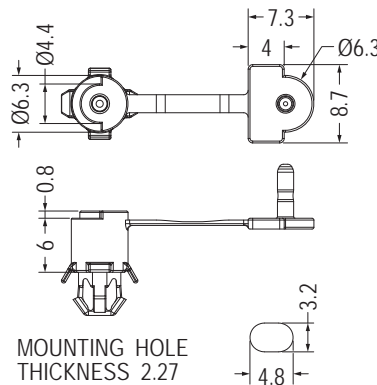

MOUNTING HOLE THICKNESS 2.27

Part No.	Package
ULCOB-2	1000

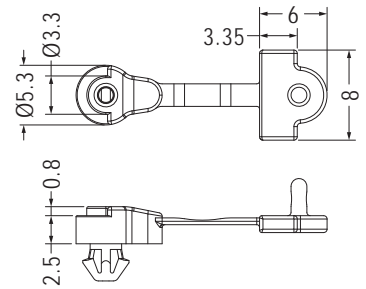

MOUNTING HOLE Ø3.0 THICKNESS 1.2

Part No.	Package
★ULCNF2.5-1.2	1000



- Material: Nylon 66 (UL)
- Flame Class: 94V-2/94V-0
- Color: Black
- Unit: mm

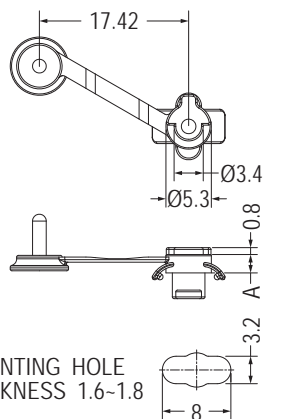

MOUNTING HOLE THICKNESS 1.6-1.8

Part No.	A	Package
ULCNA2.5-1.8	2.15	1000
ULCNA2.5-1.8S	2.45	
ULCNA4-1.8	4.0	

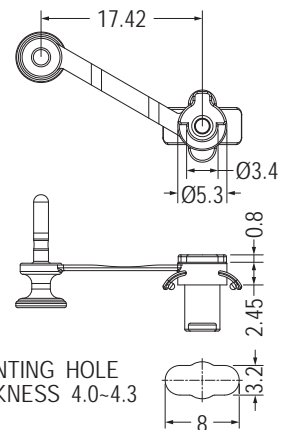

MOUNTING HOLE THICKNESS 4.0-4.3

Part No.	Package
ULCNA2.5-4.3	1000

PC板間隔柱 SPACER SUPPORT

用途：適用於NGFF卡於機板上，免工具，易拆卸。



- Material: Nylon 66 (UL)
- Flame Class: 94V-2/94V-0
- Color: Natural/Black/Green/Blue
- Unit: mm
- Patented (專利品)

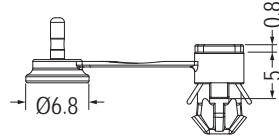
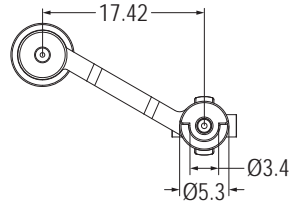

MOUNTING HOLE THICKNESS 1.6

Part No.	Package
ULCOA5-1.6A	1000

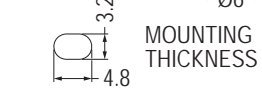
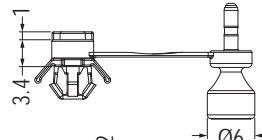
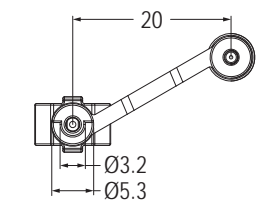

MOUNTING HOLE THICKNESS 1.6

Part No.	Package
ULCOB3.4-1.6	1000

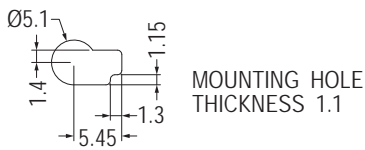
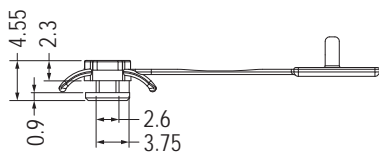
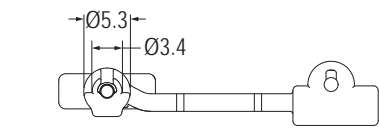

MOUNTING HOLE THICKNESS 1.1

Part No.	Package
ULCND1.5-1.1	1000

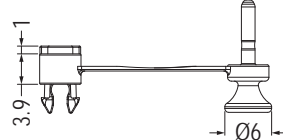
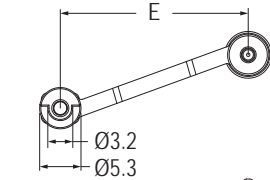

MOUNTING HOLE THICKNESS 1.6

Part No.	E	G	Package
ULCY-1	18.27	4.05	1000
ULCY3.9-1.6	24.1	4.0	

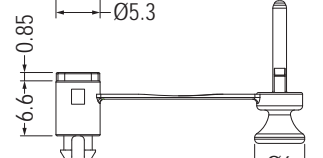
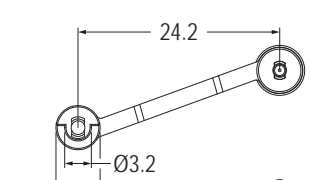

MOUNTING HOLE Ø3.4 THICKNESS 1.6

• Color: Black

Part No.	Package
ULCY-2	1000

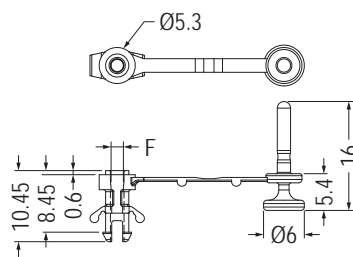
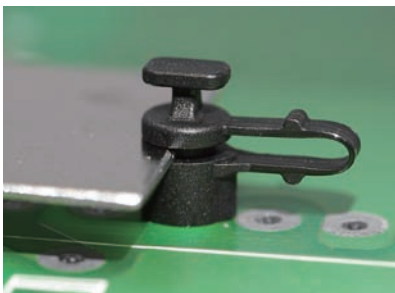

MOUNTING HOLE Ø3.5 THICKNESS 1.6-2.2

Part No.	F	Package
ULCOC-1	1.8	1000
ULCOC-9	1.77	

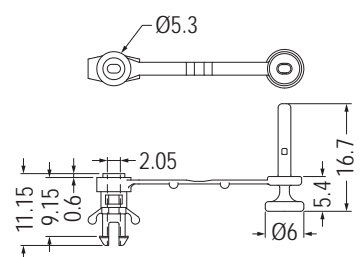

MOUNTING HOLE Ø3.5 THICKNESS 2.3-2.9

Part No.	Package
ULCOC-7L	1000

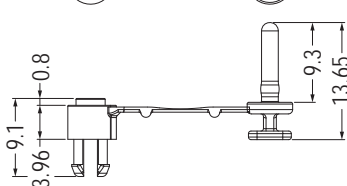
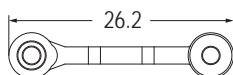

MOUNTING HOLE Ø4.0 THICKNESS 2.69

Part No.	Package
ULCOC-14	1000

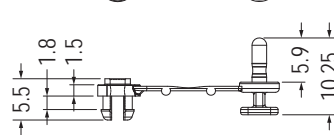
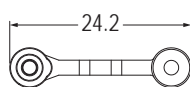

MOUNTING HOLE Ø4.0 THICKNESS 1.6

Part No.	Package
ULCOC-2	1000

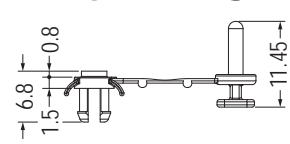
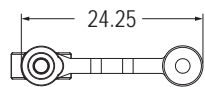

MOUNTING HOLE Ø4.0 THICKNESS 2.3-2.9

Part No.	Package
ULCOC-2L	1000

導電PC板間隔柱 CONDUCTIVE SPACER SUPPORT

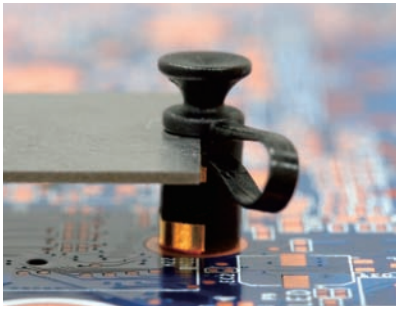

- Material: Nylon 66 (UL)
- Nut Material: Brass
- Flame Class: 94V-2/94V-0
- Color: Natural/Black
- Unit: mm
- Patented (專利品)

用途：適用NGFF卡於機板上，免工具，易拆卸，銅柱導電性佳，防E.M.I干擾。

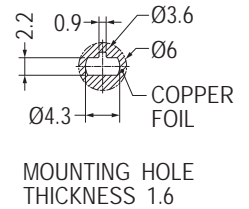
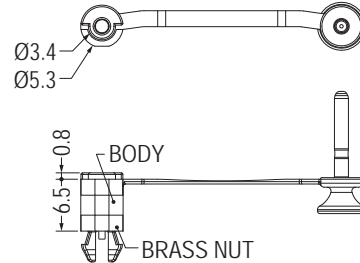
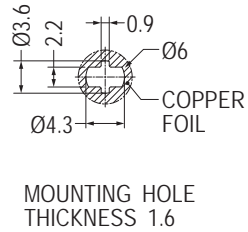
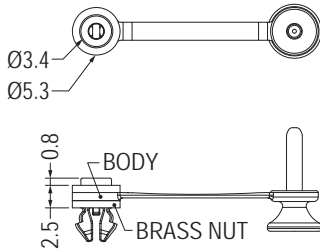

Part No.	Package
ULCOE-3	1000

Part No.	Package
ULCOE-4	1000

PC板間隔柱 SPACER SUPPORT

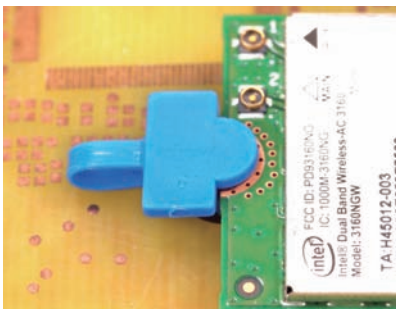

- Material: Nylon 66 (UL)
- Flame Class: 94V-2/94V-0
- Color: Natural/Black/Blue
- Unit: mm
- Patented (專利品)

用途：適用NGFF卡於機板上，免工具，易拆卸。

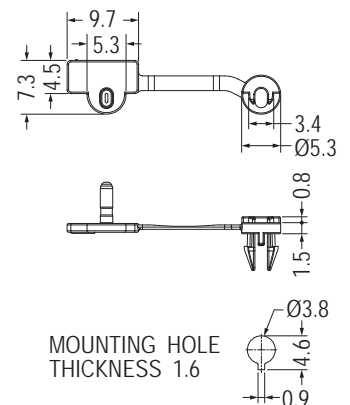
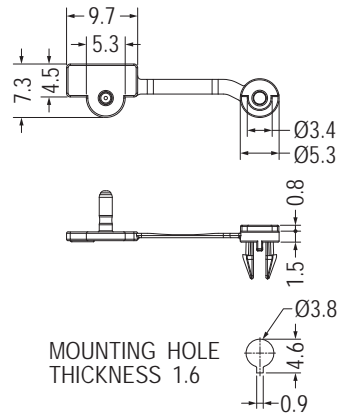
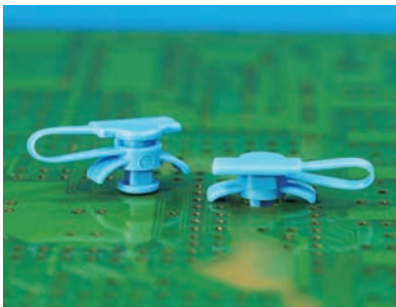

Part No.	Package
ULCOD1.5-1.6	1000

Part No.	Package
ULCOD-1	1000

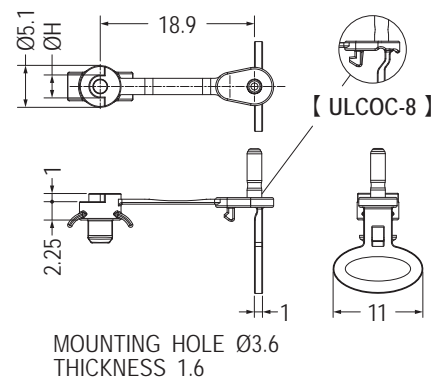
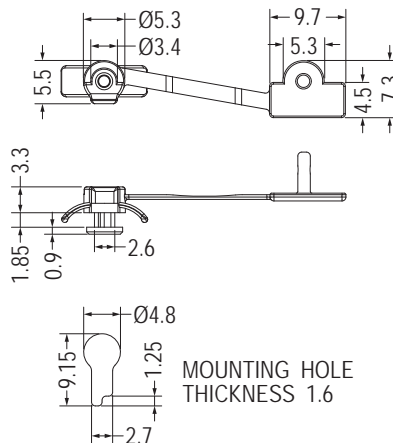

Part No.	Package
ULCND2.5-1.6	1000

Part No.	H	Package
ULCOC-4	3.4	1000
ULCOC-8	2.8	

PC板間隔柱 SPACER SUPPORT

用途：通用NGFF卡於機板上，免工具，易拆卸。

1



- Material: Nylon 66 (UL)
- Flame Class: 94V-2/94V-0
- Color: Natural/Black/Blue
- Unit: mm
- Patented (專利品)

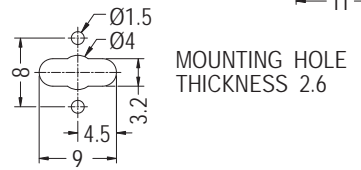
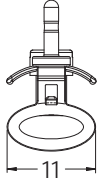
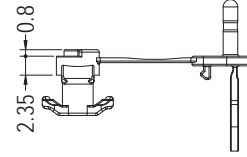
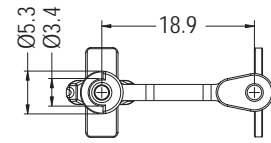
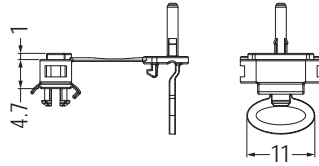
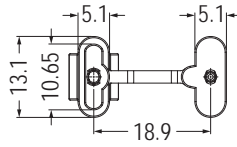

Part No.	Package
ULCOC-12	1000

Part No.	Package
ULCOC2.4-2.6	1000



- Material: Nylon 66 (UL)
- Flame Class: 94V-2/94V-0
- Color: Green
- Unit: mm
- Patented (專利品)

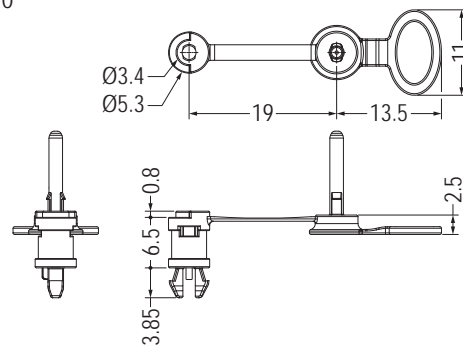

MOUNTING HOLE CHASSIS THICKNESS 1.6



Part No.	Package
ULCOM-1	1000

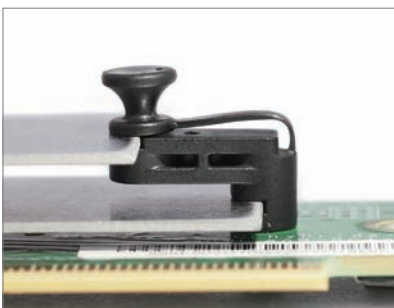

- Material: Nylon 66 (UL)
- Flame Class: 94V-2/94V-0
- Color: Black
- Unit: mm
- Patented (專利品)

用途：用於上下雙層NGFF卡之固定。

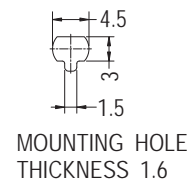
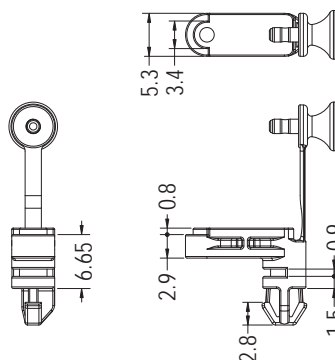

Part No.	Package
ULD-1	1000



使用說明
Installation Step

PC板間隔柱 SPACER SUPPORT

用途：適用上下雙層NGFF卡於機板上，免工具，易拆卸。

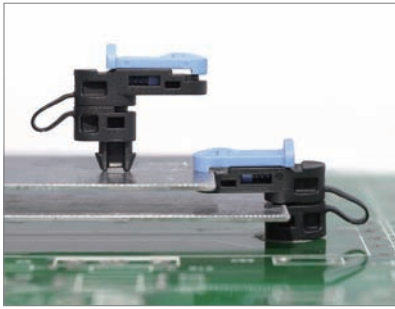

- Material: Nylon 66 (UL)
- Flame Class: 94V-0
- Base Color: Black
- Handle Color: Blue
- Unit: mm
- Patented (專利品)

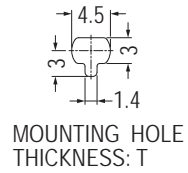
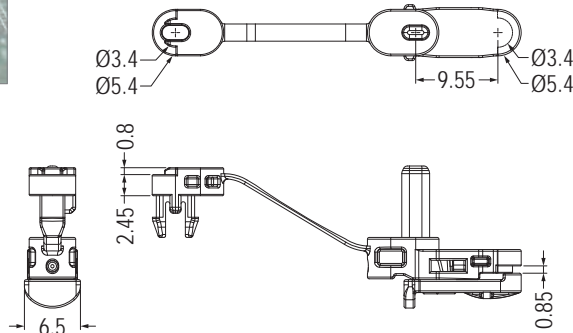
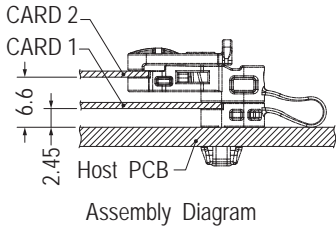

Part No.	T	Package
★ULCOF-9MF	1.93	1000
ULCOF-9F	2.36	

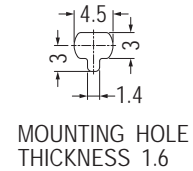
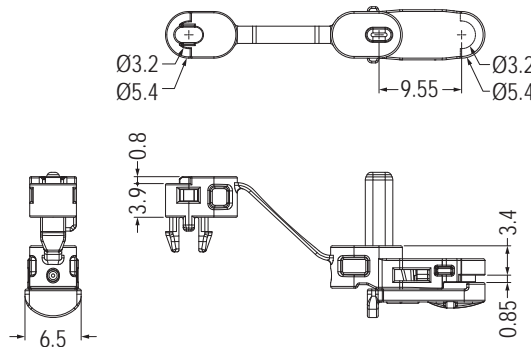
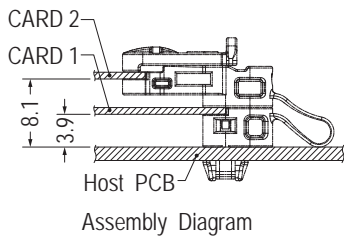

Part No.	Package
ULCOF-19F	1000

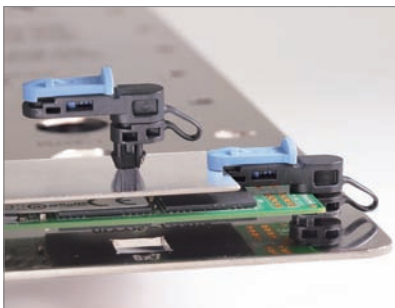

- Latch Base Material: Nylon 66 (UL)
- Latch Handle Material: Nylon 66 (UL)+GF
- Latch Spring Material: SWP Nickel Plated
- Flame Class: 94V-0
- Base Color: Black
- Handle Color: Blue
- Unit: mm
- Patented (專利品)

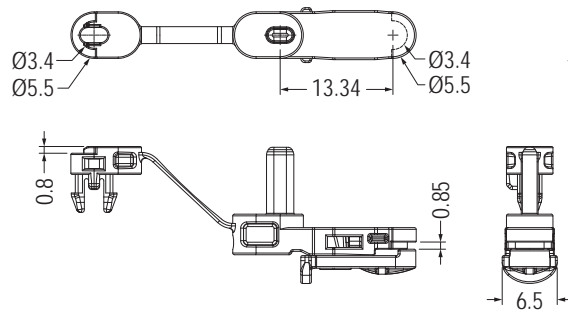
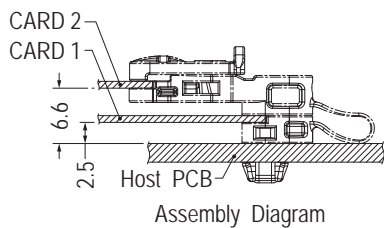

Part No.	Package
ULCOF-20F	1000



- Material: Nylon 66 (UL)
- Flame Class: 94V-0
- Color: Black
- Unit: mm
- Patented (專利品)

用途：適用NGFF卡於機板上，免工具，易拆卸。

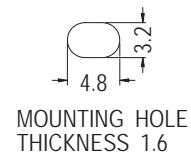
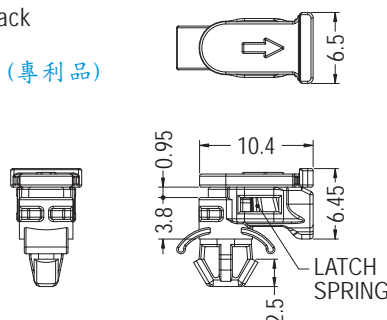

Part No.	Package
ULCOF-2F	1000

PC板間隔柱 SPACER SUPPORT

用途：通用NGFF卡於機板上，免工具，易拆卸。

1



- Material: Nylon 66 (UL)
- Flame Class: 94V-0
- Latch Base Color: Black
- Latch Cover Color: Blue
- Unit: mm
- Patented (專利品)

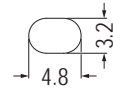
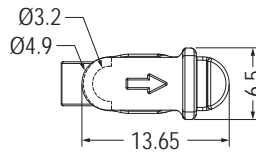

MOUNTING HOLE THICKNESS 1.6

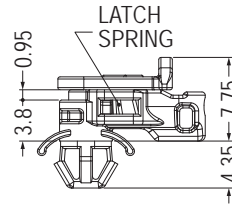
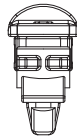

Part No.	Package
ULCOF-10F	1000

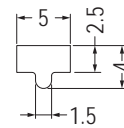
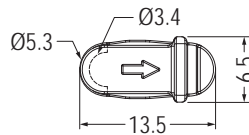

MOUNTING HOLE THICKNESS: T

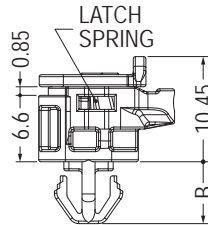
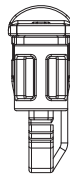

Part No.	B	T	Package
ULCOF-6SF	5.65	1.6	1000
ULCOF-6F	6.15	1.8, 2.2	
ULCOF-6LF	6.15	2.36~2.55	

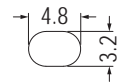
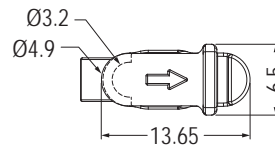
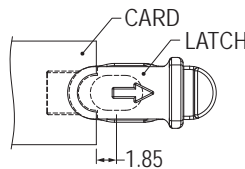
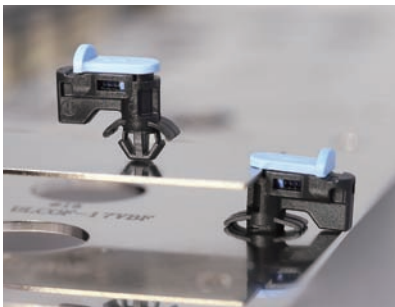

MOUNTING HOLE THICKNESS 1.57

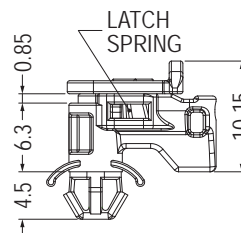
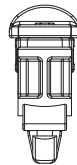

Part No.	Package
ULCOF-17F	1000

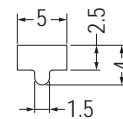
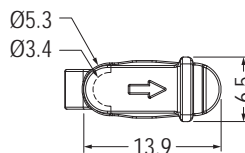
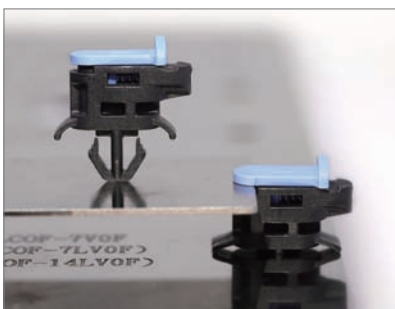

MOUNTING HOLE THICKNESS: T

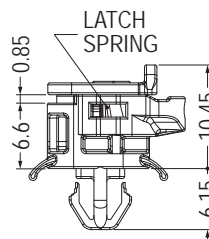

Part No.	T	Package
ULCOF-7F	1.93	1000
ULCOF-7LF	2.36~2.55	

PC板間隔柱 SPACER SUPPORT

用途：適用NGFF卡於機板上，免工具，易拆卸。

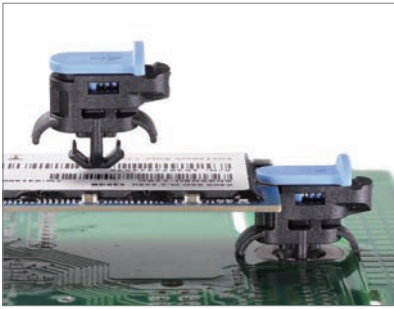

- Latch Base Material: Nylon 66 (UL)
- Latch Cover Material: Nylon 66 (UL)+GF
- Latch Spring Material: SWP Nickel Plated
- Flame Class: 94V-0
- Latch Base Color: Black
- Latch Cover Color: Blue
- Unit: mm
- Patented (專利品)

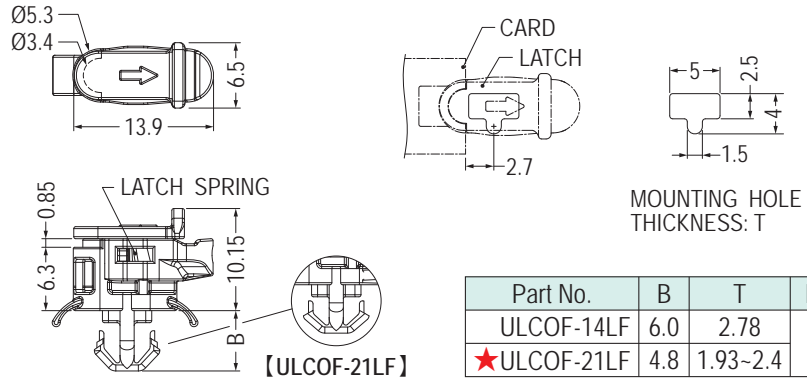

Part No.	B	T	Package
ULCOF-14LF	6.0	2.78	1000
★ULCOF-21LF	4.8	1.93-2.4	



- Material: Nylon 66 (UL)
- Body Flame Class: 94V-2
- Latch Flame Class: 94V-0
- Body Color: Black
- Latch Color: Blue
- Unit: mm
- Patented (專利品)

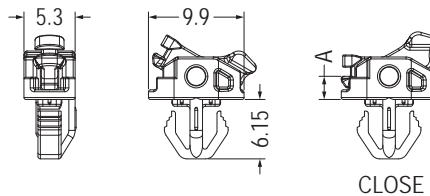
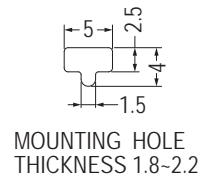
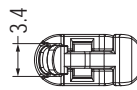

Part No.	A	Package
ULCOI-2.4F	2.4	1000
ULCOI-4F	4.0	
ULCOI-6.6F	6.6	



使用說明
Installation Step

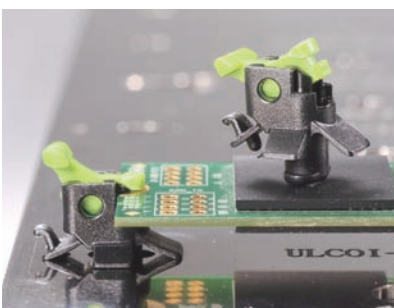

- Body Material: Nylon 66 (UL)
- Latch Material: Nylon 66 (UL)+GF
- Body Flame Class: 94V-2
- Latch Flame Class: 94V-0
- Body Color: Black
- Latch Color: Blue/Green
- Unit: mm
- Patented (專利品)

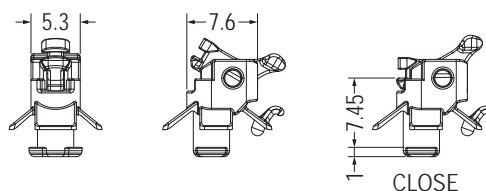
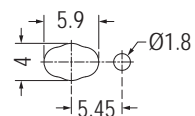
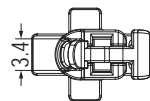

Part No.	Package
ULCOI-3F	1000

PC板間隔柱 SPACER SUPPORT

用途：適用NGFF卡於機板上，免工具，易拆卸。

1

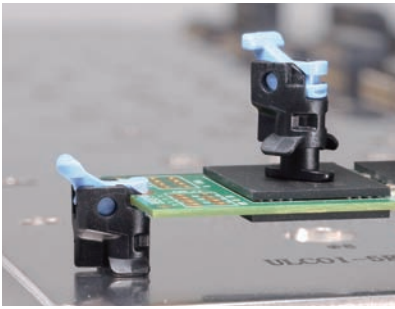

- Body Material: Nylon 66 (UL)
- Latch Material: Nylon 66 (UL)+GF
- Body Flame Class: 94V-2
- Latch Flame Class: 94V-0
- Body Color: Black
- Latch Color: Blue
- Unit: mm
- Patented (專利品)

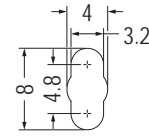
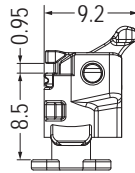
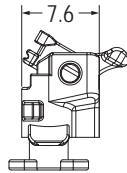
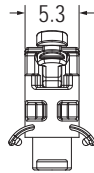
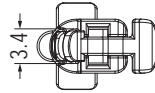
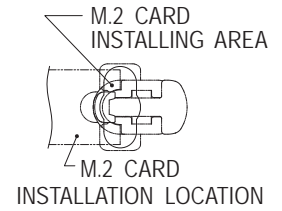

MOUNTING HOLE THICKNESS 1.9



Part No.	Package
ULCOI-5F	1000

OPEN

CLOSE



- Material: Nylon 66 (UL)
- Flame Class: 94V-0
- Latch Base Color: Black
- Latch Turn Handle Color: Blue
- Unit: mm
- Patented (專利品)

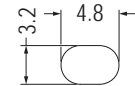
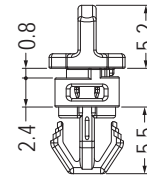
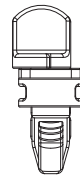
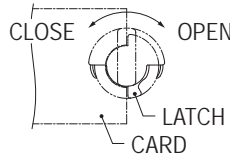
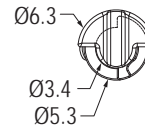

MOUNTING HOLE THICKNESS 1.6-2.1

Part No.	Package
ULCON-1F	1000



使用說明
Installation Step

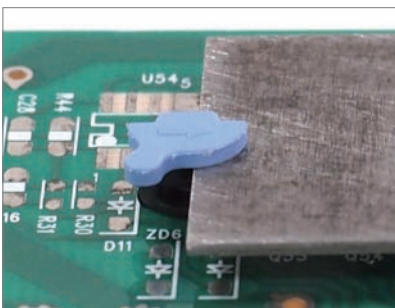

- Material: Nylon 66 (UL)
- Flame Class: 94V-0
- Latch Base Color: Black
- Latch Turn Handle Color: Blue
- Unit: mm
- Patented (專利品)

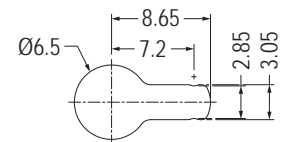
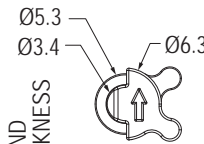

RECOMMEND MOUNTING HOLE
RECOMMEND THICKNESS 1.6

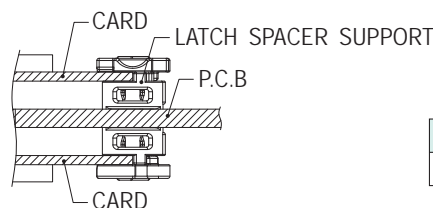
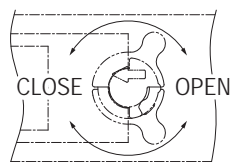
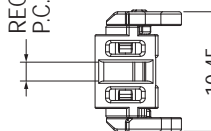
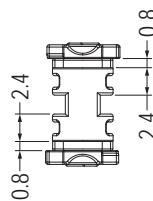

Part No.	Package
ULCON-3F	1000



使用說明
Installation Step

PC板間隔柱 SPACER SUPPORT

用途：適用NGFF卡於機板上，免工具，易拆卸。

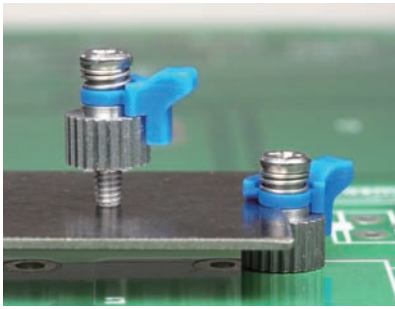

- Metal Material: Steel
- Insulator Material: POM
- Insulator Color: Blue
- Unit: mm
- Patented (專利品)

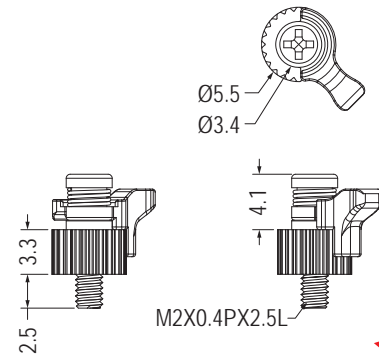
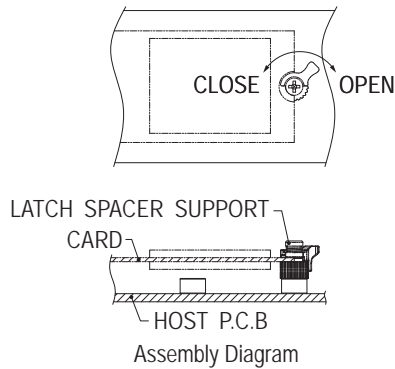

NEW

Part No.	Package
ULF-1(BU)F	1000

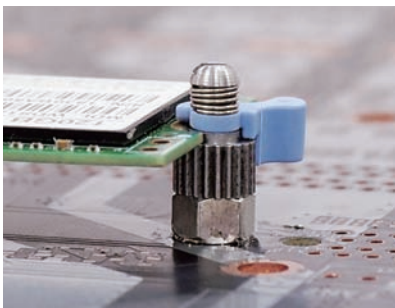

- Metal Material: Steel
- Insulator Material: Nylon 66 (UL)+GF
- Flame Class: 94V-0
- Insulator Color: Blue
- Unit: mm
- Patented (專利品)

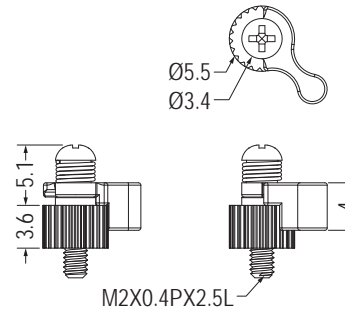
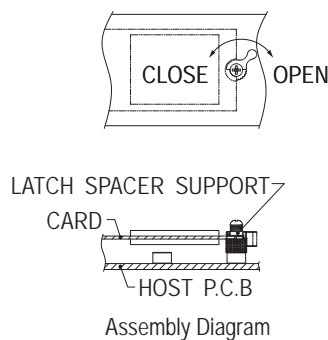

NEW

Part No.	Package
ULF-3.6(BU)F	1000



使用說明
Installation Step

固定扣 WIFI LOCK

用途：用於NGFF卡之絕緣與保護。



- Material: Nylon 66 (UL)/PC (UL)
- Flame Class: 94V-2
- Color: Black/Transparent
- Unit: mm

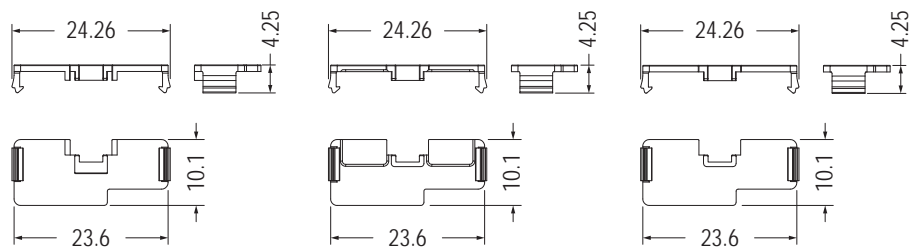

Part No.	Package
UNCV-1	1000

Part No.	Package
UNCV-2	1000

Part No.	Package
UNCV-3	1000

間隔柱 SPACER SUPPORT

用途：做為PC板與機板間之固定，需配合M3螺絲使用。



- Material: ABS (UL)
- Flame Class: 94HB
- Color: Natural
- Unit: mm

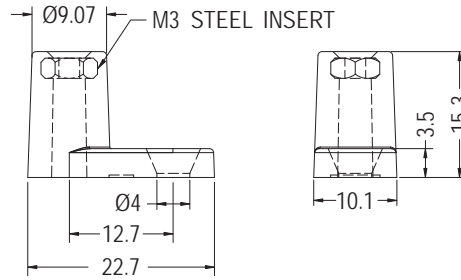

Part No.	Package
LLCB3-15	1000

PC板間隔柱 SPACER SUPPORT

用途：用於PC板與機板間之固定。



- Material: Nylon 66 (UL)
- Flame Class: 94V-2/94V-0
- Color: Natural/Black
- Unit: mm

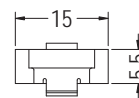
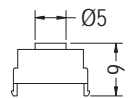
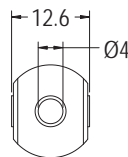

THICKNESS 1.2

Part No.	Package
DDMC-5.5	1000

圓體間隔柱 ROUND SPACER

用途：用於零件之間隔與固定。



- Material: Nylon 66 (UL)
- Flame Class: 94V-2
- Color: Black
- Unit: mm

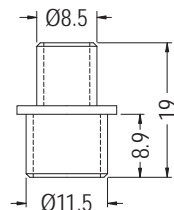
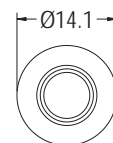
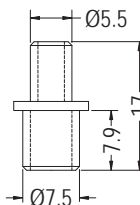

Part No.	Package
BPLT-9	1000

Part No.	Package
BPLT-13	1000

2



- LED間隔柱
LED Spacer Support
- LED座/蓋/座套
LED Holders & Covers
- LED導光蓋
LED Lens Caps
- LED導光柱
Light Pipes
- LED遮光罩
Light Pipe Masks
- 光纖座
Optical Fiber Mounts
- 燈罩
LED Covers & Lampshades



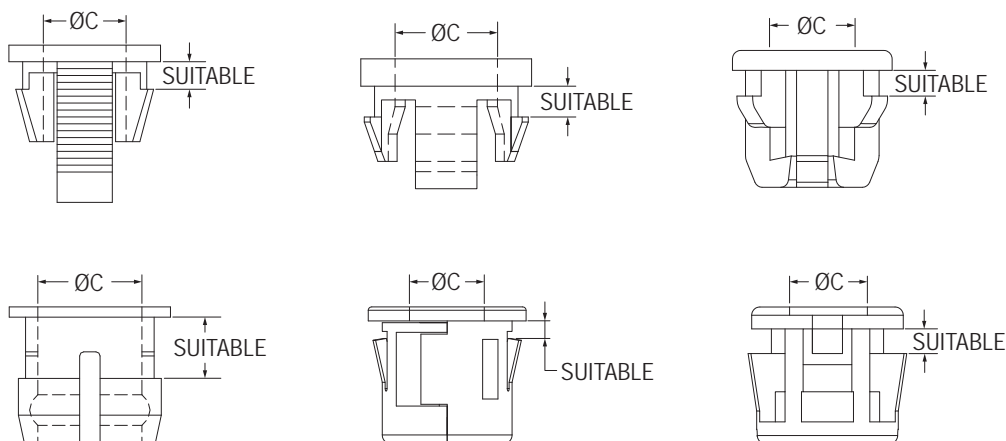

Part No.	Chassis	Suitable	ØC	Page	
LED3-53	Ø4.2-Ø4.3	0.8	3.0	2-23	
LED3-29	Ø4.3	0.8	3.0	2-21	
LED3-4	Ø4.5	0.8	3.0	2-21	
LED3-6		0.8	3.0	2-21	
LED3-45		0.8	3.0	2-22	
LED3-1		0.8~1.2	3.1	2-21	
LED3-8		0.8~1.2	3.1	2-21	
LED3-20		1.0	3.0	2-21	
LED3-7		1.6	3.0	2-21	
LED3-2		1.7	3.0	2-20	
LED3-23		Ø4.8	0.8	3.0	2-21
LED3-38		Ø5.0	0.8	2.8	2-22
LED3-49	0.8		2.87	2-28	
LED3-50	0.8		2.87	2-28	
LED3-50L	1.1		2.87	2-28	
LED3-22	0.8		3.0	2-22	
LED3-37	0.8		3.0	2-22	
LED3-31	0.8		3.0	2-28	
LED3-44	0.8		3.0	2-22	
LED3-46	0.8		3.0	2-22	
LED3-5	1.0~1.1		3.0	2-21	
LED3-17-0.6	Ø5.2	0.6	2.9	2-28	
LED3-18		0.8	2.9	2-27	
LED3-43		0.8	2.9	2-27	
LED3-55		0.8	2.9	2-27	
LED3-28		0.8	3.0	2-22	
LED3-25		0.8	3.0	2-27	
LED3-40		0.8~1.0	2.8	2-28	
LED3-40S		0.8	2.9	2-28	
LED3-17		0.8~1.0	2.9	2-27	
LED3-35		0.8~1.0	2.9	2-27	
LED3-42		0.8~1.0	2.95	2-28	
LED3-59		0.9	2.9	2-27	
LED3-30		1.1	3.0	2-28	
LED3-41		1.2	2.8	2-28	
LED3-24		1.2	2.9	2-28	

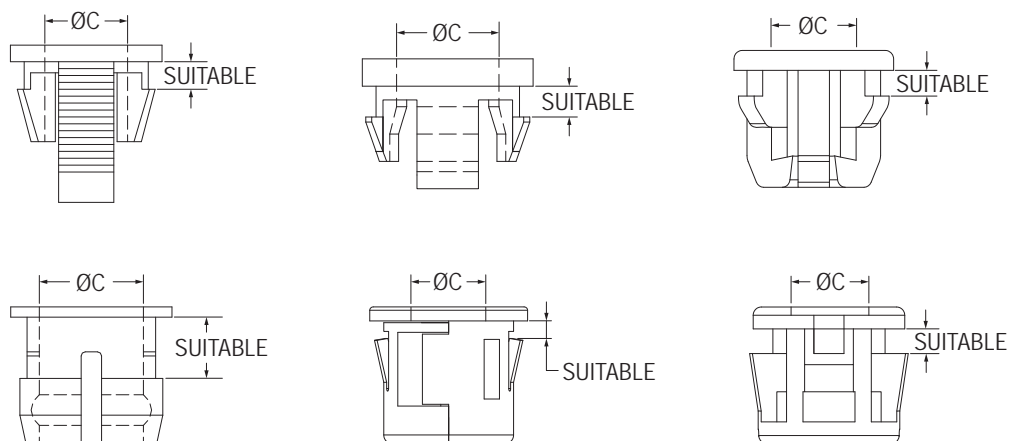

Part No.	Chassis	Suitable	ØC	Page
LED3-34	Ø5.3	0.8	3.1	2-21
LEQU3-1	Ø5.9	0.6-0.8	4.1	2-23
LEQU3-2		0.6-0.8	4.1	2-23
LED5-11	Ø6.0	0.8-1.0	5.1	2-25
LED5-5		1.8	5.1	2-24
LED5-13	Ø6.2	1.2-1.6	5.1	2-25
LED3-16	Ø6.35	0.6-1.0	3.0	2-27
LED5-8		0.9	5.0	2-25
LED3-16M		1.0-1.2	3.0	2-27
LED3-19		2.0	3.1	2-22
LED3-33	Ø6.35-Ø6.4	0.8	3.0	2-27
LED3-15	Ø6.4	0.6-1.0	3.0	2-26
LED3-15M		1.0-1.2	3.0	2-26
LED5-1S		1.2	5.0	2-23
LED5-1		1.5	5.0	2-23
LED5-2		3.0	5.1	2-24
LED5-16S	Ø6.5	0.6-1.2	5.0	2-25
LED5-14		0.8-1.0	5.0	2-26
LED5-28	Ø7.0	0.6-0.8	4.9	2-24
LED5-29		0.8	5.0	2-24
LED5-9S		0.8	5.1	2-25
LED5-24		0.8-1.0	5.0	2-28
LED5-9		0.8-1.4	5.1	2-25
LED5-24M	Ø7.0	1.2	5.0	2-28
LED5-24L		1.6	5.0	2-28
LED5-6	7.0X6.0	1.0	5.8	2-24
LED5-25	Ø7.2	1.2	5.0	2-26
LED3-14	Ø7.5	0.6-1.0	3.0	2-26
LED5-18		0.6-1.0	5.0	2-27
LED3-14M		1.0-1.2	3.0	2-26
LED5-18M		1.0-1.2	5.0	2-27
LED5-18L		1.5	5.0	2-27
LED5-17	Ø9.0	0.6-1.0	5.0	2-27
LED5-17M		1.0-1.2	5.0	2-27

LED間隔柱 LED SPACER SUPPORT

用途：用於保護 $\varnothing 5$ mm LED立於PC板上，使高度一致，接腳不會彎曲、折斷、短路。

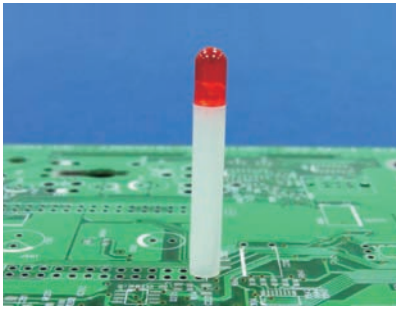

- Material: Nylon 66 (UL)
- Flame Class: 94V-2/94V-0
- Color: Natural/Black
- Unit: mm

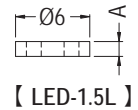
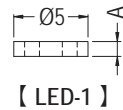
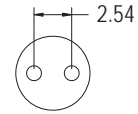
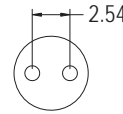
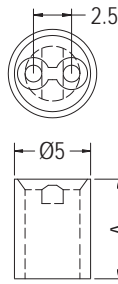

【 LED-1 】

【 LED-1.5L 】

Part No.	A	Package
LED-1	1.0	2000
LED-1.5	1.5	
LED-1.5L	1.5	
LED-2	2.0	
LED-2.5	2.5	
LED-3	3.0	
LED-3.5	3.5	
LED-4	4.0	
LED-4.5	4.5	
LED-5	5.0	
LED-5.5	5.5	
LED-6	6.0	
LED-6.5	6.5	
LED-6.8	6.8	
LED-7	7.0	
LED-7.5	7.5	
LED-8	8.0	
LED-8.5	8.5	

Part No.	A	Package
LED-8.8	8.8	2000
LED-9	9.0	
LED-9.5	9.5	
LED-10	10.0	
LED-10S	10.0	
LED-10.5	10.5	
LED-11	11.0	
LED-11.5	11.5	
LED-12	12.0	
LED-12.5	12.5	
LED-13	13.0	
LED-13.5	13.5	
LED-14	14.0	
LED-14.5	14.5	
LED-15	15.0	
LED-15.5	15.5	
LED-16	16.0	
LED-16.5	16.5	

Part No.	A	Package
LED-17	17.0	1000
LED-17.5	17.5	
LED-17.7	17.7	
LED-18	18.0	
LED-18.5	18.5	
LED-19	19.0	
LED-19.5	19.5	
LED-20	20.0	
LED-20.5	20.5	
LED-21	21.0	
LED-21.5	21.5	
LED-22	22.0	
LED-22.5	22.5	
LED-23	23.0	
LED-23.5	23.5	
LED-24	24.0	
LED-28	28.0	

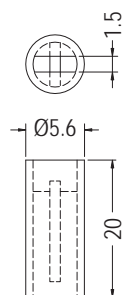
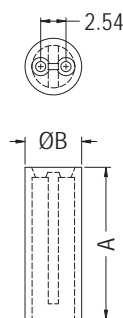

Part No.	A	B	Package
LEDW-2	2.0	5.6	2000
LEDW-5	5.0	5.0	
LEDW-7.5	7.5	5.0	
LEDW-9	9.0	5.0	
LEDW-12	12.0	5.0	
LEDW-15	15.0	5.6	
LEDW-16	16.0	5.6	1000
LEDW-17	17.0	5.6	
LEDW-18.5	18.5	5.6	
LEDW-19	19.0	5.6	
LEDW-21	21.0	5.6	
LEDW-21.5	21.5	5.6	
LEDW-22	22.0	5.6	
LEDW-23.5	23.5	5.6	

Part No.	Package
LEDW-20	1000

LED間隔柱 LED SPACER SUPPORT



- Material: Nylon 66 (UL)
- Flame Class: 94V-2/94V-0
- Color: Natural/Black
- Unit: mm

用途：用於保護 $\varnothing 3$ mm LED立於PC板上，使高度一致，中間隔板設計，接腳不會彎曲、折斷、短路。

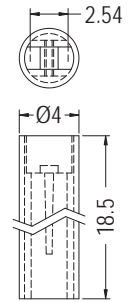
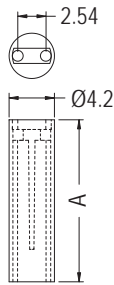

Part No.	A	Package
LEDEW-5	5.0	1000
LEDEW-8.5	8.5	
LEDEW-15	15.0	
LEDEW-17	17.0	
LEDEW-17.5	17.5	

Part No.	Package
LEDSW-18.5	1000



- Material: Nylon 66 (UL)
- Flame Class: 94V-2/94V-0
- Color: Natural/Black
- Unit: mm

用途：使LED立於PC板上，高度一致，不斷腳。

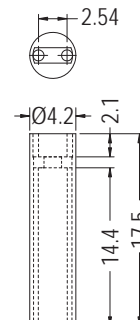
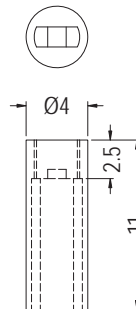
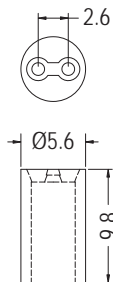

Part No.	Package
LEDLA-9.8	2000

Part No.	Package
LEDSB-11	2000

Part No.	Package
LEDE-17.5	1000

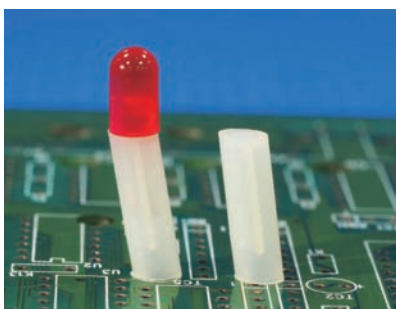

- Material: Nylon 66 (UL)
- Flame Class: 94V-2/94V-0
- Color: Natural/Black
- Unit: mm

用途：使LED成 80.5° 焊於PC板上，高度一致，不斷腳，中間有隔板不短路。

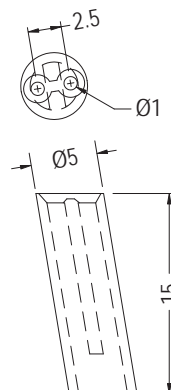

Part No.	Package
LEDA-15	1000

LED間隔柱 LED SPACER SUPPORT

用途：用於保護 $\varnothing 3$ mm LED立於PC板上，接腳不會彎曲、折斷、短路，且使LED高度一致，免用治具，尺寸齊全。

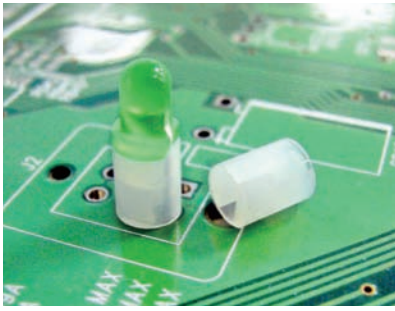

- Material: Nylon 66 (UL)
- Flame Class: 94V-2/94V-0
- Color: Natural/Black
- Unit: mm

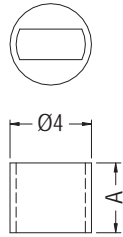
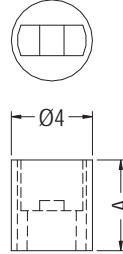

【LEDS-0.8-LEDS-3.5】

Part No.	A	Package
LEDS-0.8	0.8	2000
LEDS-1	1.0	
LEDS-1.5	1.5	
LEDS-2	2.0	
LEDS-2.5	2.5	
LEDS-3	3.0	
LEDS-3.5	3.5	
LEDS-4	4.0	
LEDS-4.5	4.5	
LEDS-5	5.0	
LEDS-5.5	5.5	
LEDS-6	6.0	
LEDS-6.5	6.5	

Part No.	A	Package
LEDS-7	7.0	2000
LEDS-7.5	7.5	
LEDS-8	8.0	
LEDS-8.5	8.5	
LEDS-9	9.0	
LEDS-9.5	9.5	
LEDS-9.8	9.8	
LEDS-10	10.0	
LEDS-10.5	10.5	
LEDS-11	11.0	
LEDS-11.5	11.5	
LEDS-12	12.0	
LEDS-12.5	12.5	
LEDS-13	13.0	
LEDS-13.5	13.5	
LEDS-14	14.0	
LEDS-14.5	14.5	
LEDS-15	15.0	

Part No.	A	Package
LEDS-15.5	15.5	2000
LEDS-16	16.0	
LEDS-16.5	16.5	
LEDS-17	17.0	1000
LEDS-17.5	17.5	
LEDS-18	18.0	
LEDS-18.5	18.5	
LEDS-19	19.0	
LEDS-19.5	19.5	
LEDS-20	20.0	
LEDS-20.5	20.5	
LEDS-21	21.0	
LEDS-21.5	21.5	
LEDS-22	22.0	
LEDS-22.5	22.5	
LEDS-23	23.0	
LEDS-23.5	23.5	
LEDS-24	24.0	

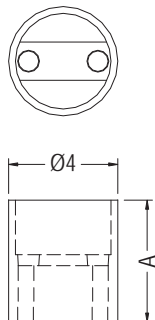

Part No.	A	Package
LEDS-3S	3.0	2000
LEDS-4S	4.0	
LEDS-4.5S	4.5	
LEDS-5S	5.0	
LEDS-5.5S	5.5	
LEDS-6S	6.0	
LEDS-6.5S	6.5	
LEDS-7S	7.0	
LEDS-7.5S	7.5	
LEDS-8S	8.0	
LEDS-8.5S	8.5	
LEDS-9S	9.0	
LEDS-9.5S	9.5	
LEDS-10S	10.0	
LEDS-11S	11.0	
LEDS-11.5S	11.5	
LEDS-12S	12.0	
LEDS-12.5S	12.5	

Part No.	A	Package
LEDS-13S	13.0	2000
LEDS-13.5S	13.5	
LEDS-14.5S	14.5	
LEDS-15S	15.0	
LEDS-15.5S	15.5	
LEDS-16S	16.0	
LEDS-16.5S	16.5	1000
LEDS-17S	17.0	
LEDS-17.5S	17.5	
LEDS-18S	18.0	
LEDS-18.5S	18.5	
LEDS-19S	19.0	
LEDS-20S	20.0	
LEDS-20.5S	20.5	
LEDS-21S	21.0	
LEDS-21.5S	21.5	
LEDS-22S	22.0	
LEDS-22.5S	22.5	
LEDS-23S	23.0	

LED間隔柱 LED SPACER SUPPORT

用途：使 $\varnothing 3$ mm LED立於PC板上，高度一致，不斷腳。



- Material: Nylon 66 (UL)
- Flame Class: 94V-2/94V-0
- Color: Natural/Black
- Unit: mm

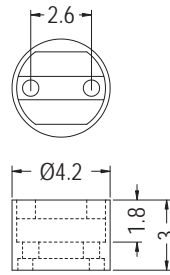

Part No.	Package
LEDL-3	2000

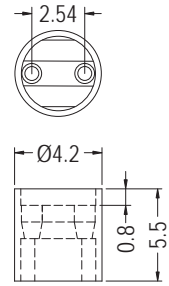

Part No.	Package
LEDL-5.5	2000

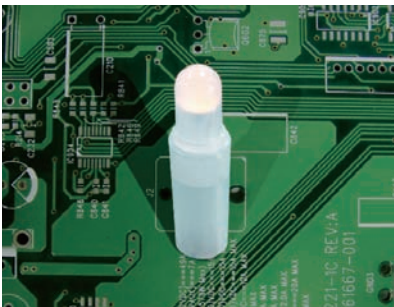

- Material: Nylon 66 (UL)
- Flame Class: 94V-2/94V-0
- Color: Natural/Black
- Unit: mm

用途：使3 PIN $\varnothing 3$ mm LED立於PC板上，高度一致，不斷腳。

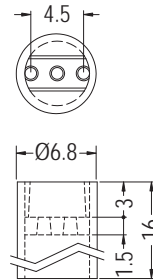

Part No.	Package
LEH3-16	2000



- Material: Nylon 66 (UL)
- Flame Class: 94V-2/94V-0
- Color: Natural/Black
- Unit: mm

用途：使 $\varnothing 5$ mm LED固定於PC板上，高度一致，不斷腳。

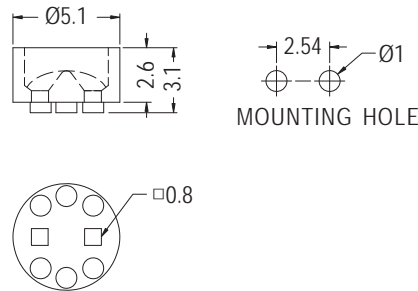

Part No.	Package
LED2M-3.6	2000

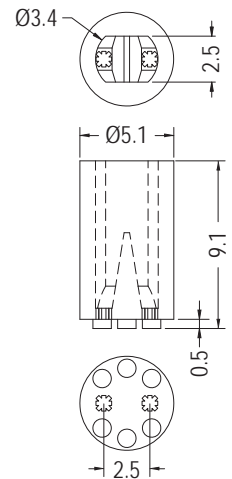

Part No.	Package
LED2M-9.1	2000

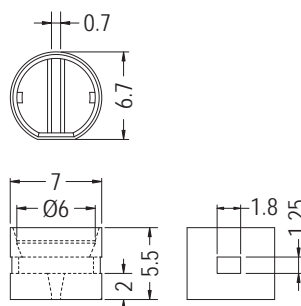

- 適用 $\varnothing 5$ LED帽緣款
- 適用於2 PIN、3 PIN

Part No.	Package
LEDF-2	2000

LED間隔柱 LED SPACER SUPPORT

用途：使LED固定於PC板上，高度一致，不斷腳。



- Material: Nylon 66 (UL)
- Flame Class: 94V-2/94V-0
- Color: Natural/Black
- Unit: mm

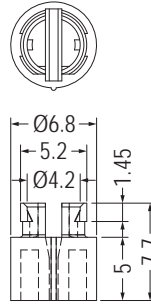

Part No.	Package
LEDF-3	2000

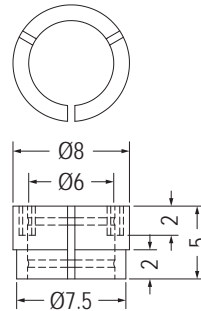

Part No.	Package
COC8-5	2000

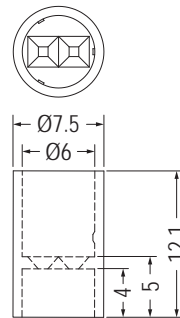
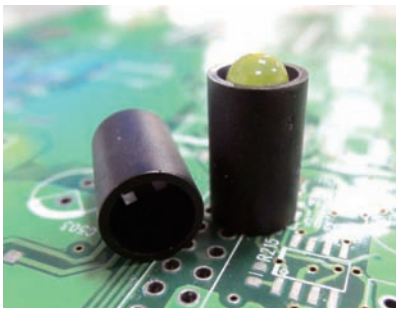

Part No.	Package
LEDD-12	1000



- Material: Nylon 66 (UL)
- Flame Class: 94V-2/94V-0
- Color: Natural/Black
- Unit: mm

用途：用於保護Ø3 mm LED立於PC板上，高度一致，不斷腳，有遮光效果，不漏光。

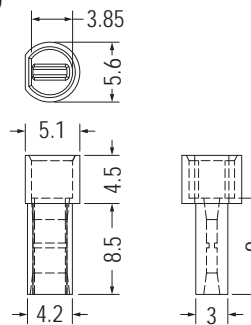

Part No.	Package
LEDZ3-9	2000



- Material: Nylon 66 (UL)
- Flame Class: 94V-2/94V-0
- Color: Natural/Black
- Unit: mm

用途：用於保護Ø5 mm LED立於PC板上，高度一致，不斷腳，有遮光效果，不漏光。

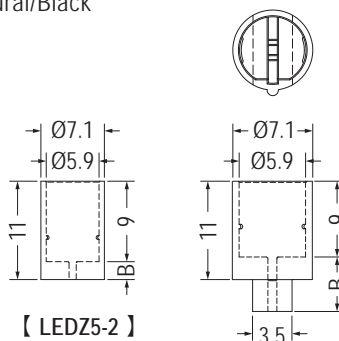

Part No.	B	Package
LEDZ5-2	2.0	2000
LEDZ5-3	3.0	
LEDZ5-4	4.0	
LEDZ5-5	5.0	
LEDZ5-6	6.0	
LEDZ5-7	7.0	
LEDZ5-8	8.0	
LEDZ5-9	9.0	
LEDZ5-10	10.0	

LED間隔柱 LED SPACER SUPPORT

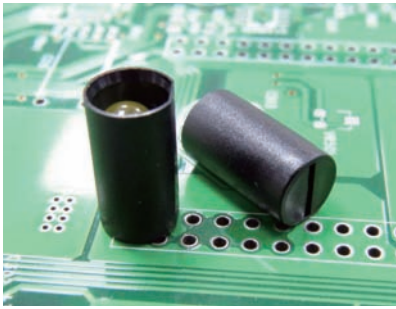

- Material: Nylon 66 (UL)
- Flame Class: 94V-2/94V-0
- Color: Natural/Black
- Unit: mm

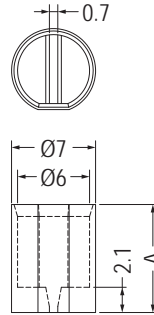

用途：用於保護 $\varnothing 5$ mm LED立於PC板上，高度一致，不斷腳，有遮光效果，不漏光。

Part No.	A	Package
LEDX5-1	9.0	2000
LEDX5-2	12.5	1000

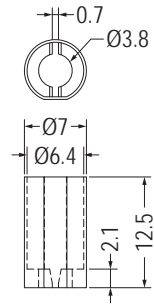
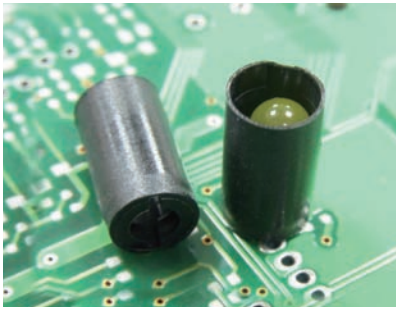

Part No.	Package
LEDX5-2	1000

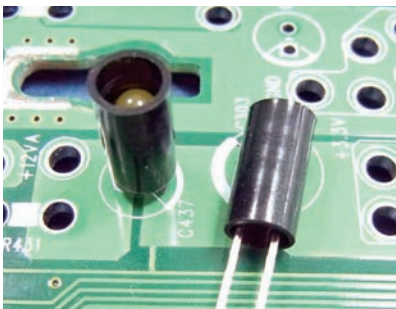

- Material: Nylon 66 (UL)
- Flame Class: 94V-2/94V-0
- Color: Natural/Black
- Unit: mm

用途：用於保護 $\varnothing 3$ mm LED立於PC板上，高度一致，不斷腳，不漏光。

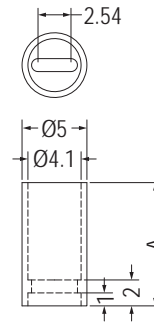

Part No.	A	Package
LEDX3-1	9.5	1000
LEDX3-3	8.0	

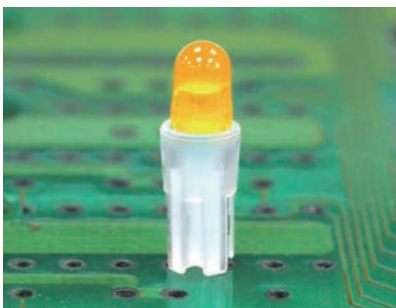

- Material: Nylon 66 (UL)
- Flame Class: 94V-2/94V-0
- Color: Natural/Black
- Unit: mm

用途：使LED立於PC板上，高度一致，不斷腳。

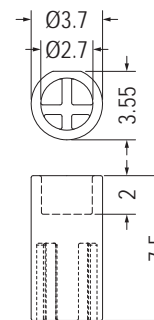

Part No.	Package
LEDXB-7.5	1000

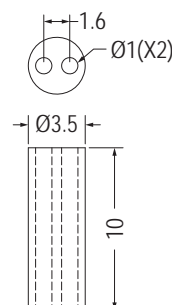
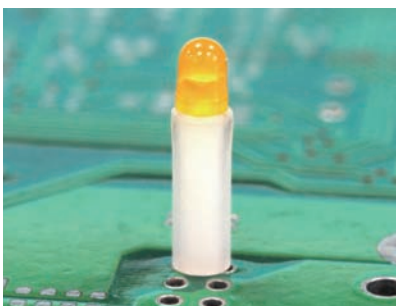

Part No.	Package
LEDBF-10	1000

LED間隔柱 LED SPACER SUPPORT

2



- Material: Nylon 66 (UL)
- Flame Class: 94V-2/94V-0
- Color: Natural/Black
- Unit: mm

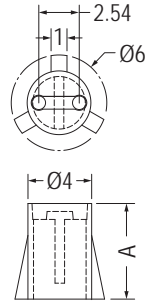

Part No.	A	Package
LEDO-6	6.5	2000
LEDO-9.5	9.5	
LEDO-15.5	15.5	1000

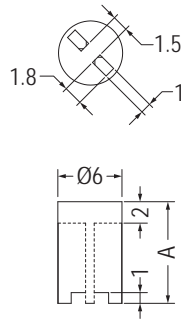

Part No.	A	Package
LEDXV-4.8	4.8	2000
LEDXV-6.5	6.5	
LEDXV-9.5	9.5	
LEDXV-12.7	12.7	
LEDXV-19.1	19.1	
LEDXV-22.2	22.2	
LEDXV-25.4	25.4	

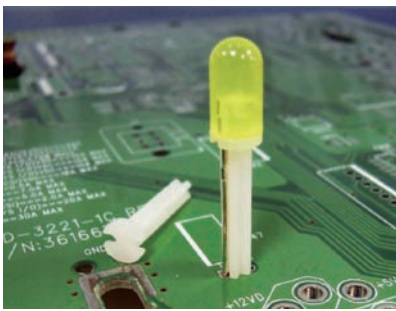

- Material: ABS (UL)
- Flame Class: 94HB
- Color: Natural
- Unit: mm

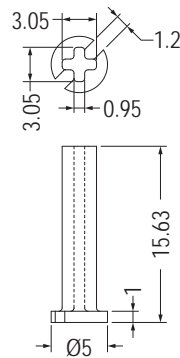

Part No.	Package
LEDXA-15.6	2000

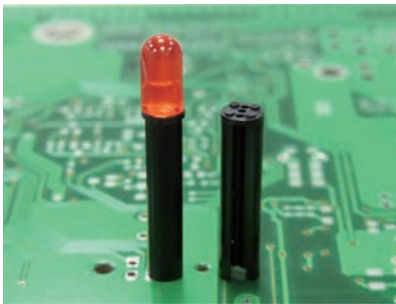

- Material: PBT (UL)
- Flame Class: 94V-0
- Color: Black
- Unit: mm

用途：用於保護Ø5 mm LED立於PC板上，高度一致，接腳不彎曲，折斷、短路。

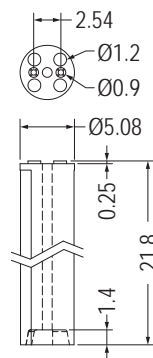

Part No.	Package
LEDAA-22	1000



- Material: Nylon 66 (UL)
- Flame Class: 94V-2/94V-0
- Color: Natural/Black
- Unit: mm

用途：使3 PIN Ø3 mm LED固定於PC板上，高度一致，不斷腳。

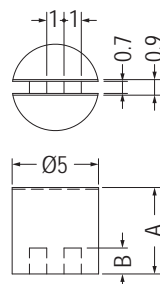

Part No.	A	B	Package
LEDM-3	3.0	1.0	2000
LEDM-4	4.0	1.0	
LEDM-5	5.0	1.5	
LEDM-8	8.0	5.0	1000
LEDM-16	16.0	13.0	

LED間隔柱 LED SPACER SUPPORT

用途：使3 PIN Ø3 mm LED固定於PC板上，高度一致，不斷腳。

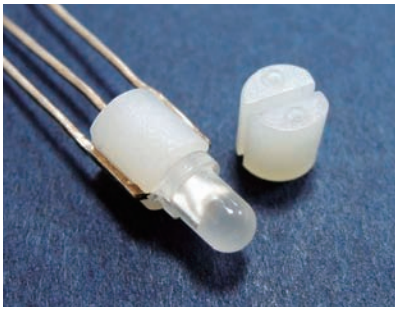

- Material: Nylon 66 (UL)
- Flame Class: 94V-2/94V-0
- Color: Natural/Black
- Unit: mm

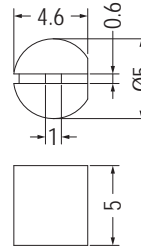

Part No.	Package
LEDQ-5	2000



- Material: Nylon 66 (UL)
- Flame Class: 94V-2/94V-0
- Color: Natural/Black
- Unit: mm

用途：使LED固定於PC板上，高度一致，不斷腳。

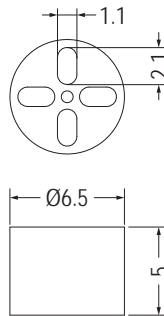

Part No.	Package
★LEDAJ-5	2000

- Material: TPE
- Color: Black
- Unit: mm

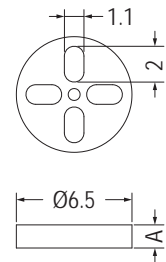

Part No.	A	Package
LEDAJ-1.3	1.3	2000
LEDAJ-7.9	7.9	

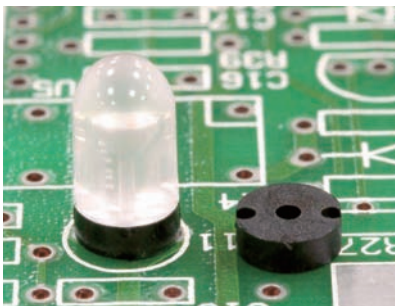

- Material: Nylon 66 (UL)
- Flame Class: 94V-2/94V-0
- Color: Natural/Black
- Unit: mm

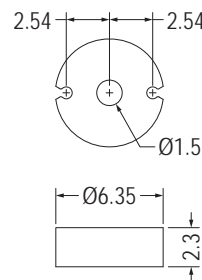

Part No.	Package
LEDHB-2.3	2000

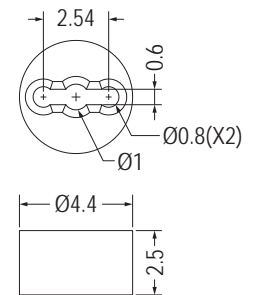

Part No.	Package
LEDBA-2.5	1000

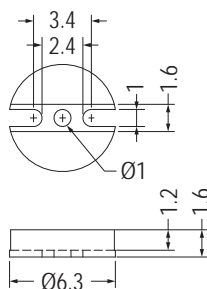

Part No.	Package
LEDBC-1.6	2000

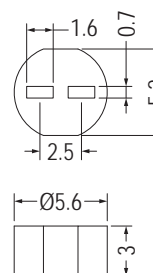

Part No.	Package
LEDBB-3	2000

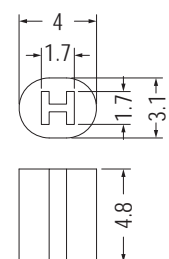

Part No.	Package
LEDBD-4.8	1000

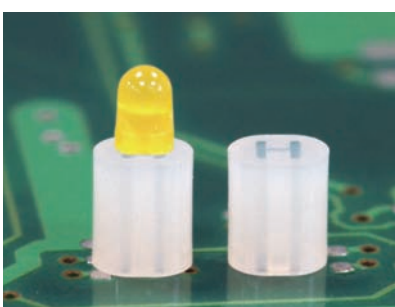

LED間隔柱 LED SPACER SUPPORT

用途：使LED立於PC板上，高度一致，不斷腳。

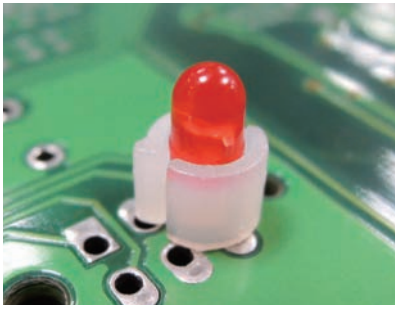

- Material: Nylon 66 (UL)
- Flame Class: 94V-2/94V-0
- Color: Natural/Black
- Unit: mm

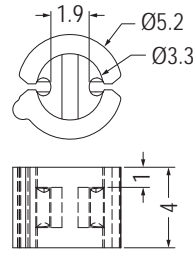

Part No.	Package
LEDHC-4	2000

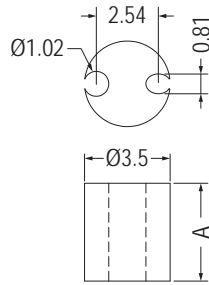
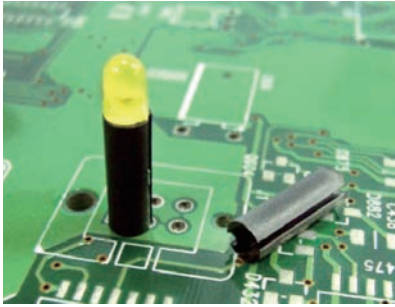

Part No.	A	Package
LEDG-3	3.0	2000
LEDG-10	10.1	

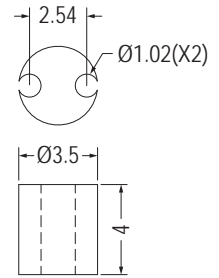

Part No.	Package
LEDG-4	2000

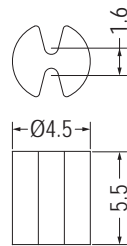

Part No.	Package
LEDV-5.5	2000

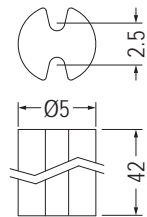

Part No.	Package
LEDV-42	1000

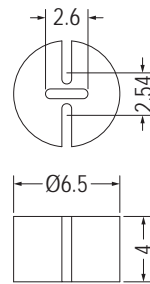
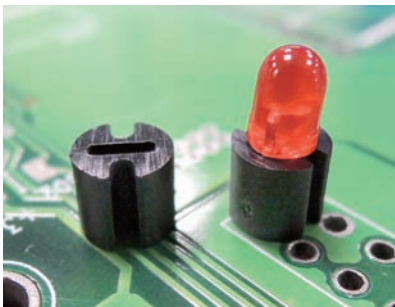

Part No.	Package
LEDHA-4	2000

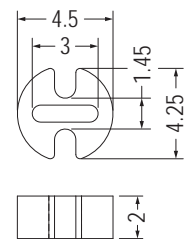

Part No.	Package
LEDH-2S	2000

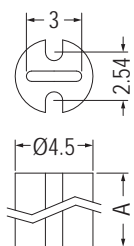

Part No.	A	Package
LEDH-1	1.0	2000
LEDH-1.5	1.5	
LEDH-2	2.0	
LEDH-2.5	2.5	
LEDH-3	3.0	
LEDH-3.5	3.5	
LEDH-4	4.0	
LEDH-4.5	4.5	
LEDH-5	5.0	
LEDH-5.5	5.5	
LEDH-6	6.0	

Part No.	A	Package
LEDH-6.5	6.5	2000
LEDH-7	7.0	
LEDH-7.5	7.5	
LEDH-8	8.0	
LEDH-8.5	8.5	
LEDH-9	9.0	
LEDH-9.5	9.5	
LEDH-10	10.0	
LEDH-10.5	10.5	
LEDH-11	11.0	
LEDH-11.5	11.5	

Part No.	A	Package	
LEDH-12	12.0	2000	
LEDH-12.5	12.5		
LEDH-13	13.0		
LEDH-13.5	13.5		
LEDH-14	14.0		
LEDH-14.5	14.5		
LEDH-15	15.0		
LEDH-15.5	15.5		
LEDH-16	16.0		
LEDH-17	17.0		
★LEDH-17.5	17.5		1000
LEDH-18	18.0		

LED間隔柱 LED SPACER SUPPORT

用途：使LED立於PC板上，高度一致，不斷腳。



- Material: Nylon 66 (UL)
- Flame Class: 94V-2/94V-0
- Color: Natural/Black
- Unit: mm

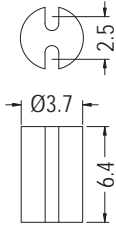

- Material: TPE
- Color: Black

Part No.	Package
LEDT-6.4S	1000

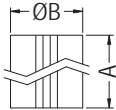
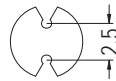
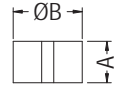
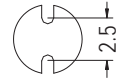

【 LEDT-5-LEDT-14.5 】

Part No.	A	B	Package
LEDT-2.4	2.4	4.0	2000
LEDT-5S	5.0	4.0	1000
LEDT-7S	7.0	3.7	2000
LEDT-5	5.0	5.0	1000
LEDT-5.5	5.5	5.0	
LEDT-8	8.0	5.0	
LEDT-9	9.0	5.0	
LEDT-11	11.0	5.0	
LEDT-14.5	14.5	5.0	
LEDT-16.1	16.1	5.0	
LEDT-16.4	16.4	5.0	
LEDT-17.5	17.5	5.0	
LEDT-20	20.2	5.0	
LEDT-22	22.0	5.0	
LEDT-22.7	22.7	5.0	
LEDT-23.5	23.5	5.0	
LEDT-26	26.0	5.0	

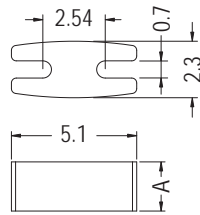
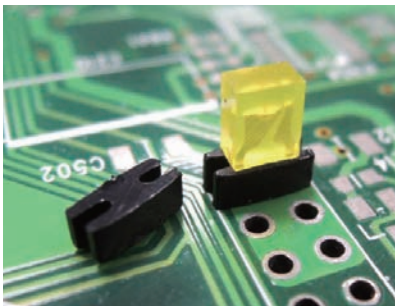

Part No.	A	Package
LEDSH-2	2.0	2000
LEDSH-3.5	3.5	
LEDSH-6	6.0	

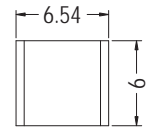
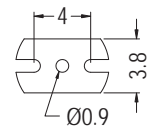

Part No.	Package
LEDSA-6	2000

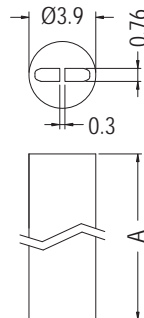
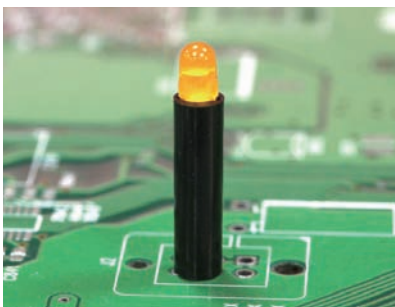

Part No.	A	Package
LEDAC-14.5	14.5	1000
LEDAC-18	18.0	

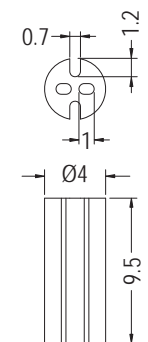

- Material: TPE
- Color: Black

Part No.	Package
LEDAK-9.5	2000

LED間隔柱 LED SPACER SUPPORT

用途：用於保護 $\varnothing 5$ mm LED立於PC板上，使高度一致，中間隔板設計，接腳不會彎曲、折斷、短路，有定位腳，不歪斜。

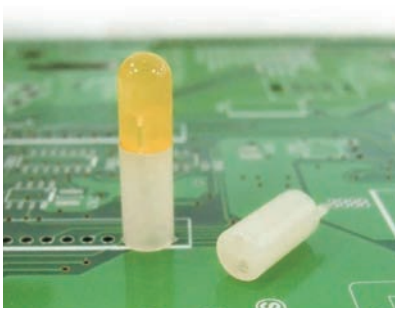

- Material: Nylon 66 (UL)
- Flame Class: 94V-2/94V-0
- Color: Natural/Black
- Unit: mm

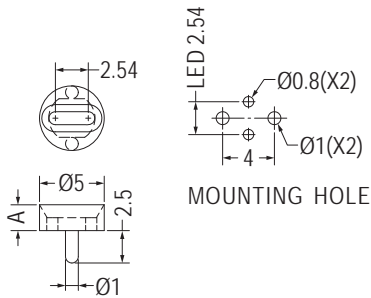

Part No.	A	Package
LEDK-2	2.0	2000
LEDK-3	3.0	2000

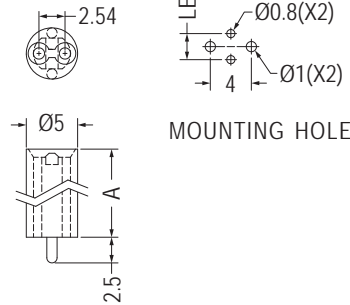

Part No.	A	Package
LEDK-4	4.0	2000
LEDK-6	6.0	
LEDK-7	7.0	
LEDK-8	8.0	
LEDK-9	9.0	
LEDK-10	10.0	
LEDK-11	11.0	1000
LEDK-11.5	11.5	
LEDK-12	12.0	
LEDK-12.5	12.5	
LEDK-13	13.0	
LEDK-14	14.0	
LEDK-18	18.0	
LEDK-20	20.0	

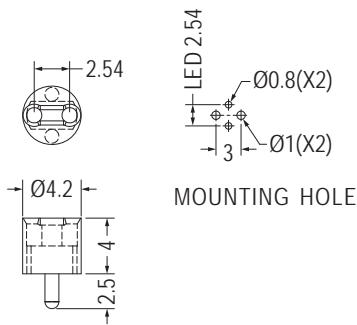

Part No.	Package
LEDK-4S	1000

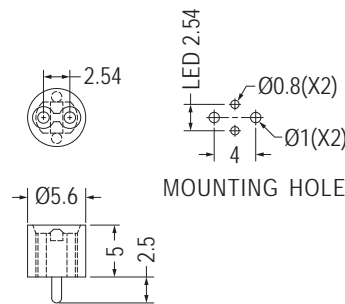

Part No.	Package
LEDK-5	1000

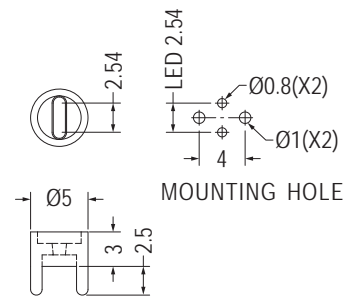

Part No.	Package
LEDKU-2	1000



- Material: Nylon 66 (UL)
- Flame Class: 94V-2/94V-0
- Color: Natural/Black
- Unit: mm

用途：用於保護 $\varnothing 3$ mm LED立於PC板上，使高度一致，中間隔板設計，接腳不會彎曲、折斷、短路，有定位腳，不歪斜。

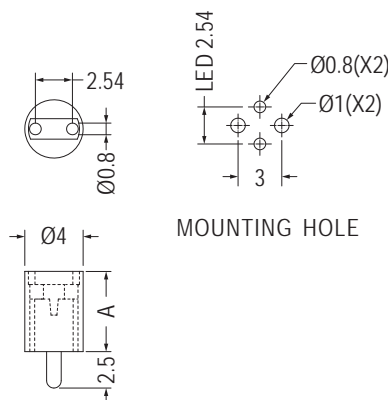

Part No.	A	Package
LEDWK-5.5	5.5	1000
LEDWK-6	6.0	
LEDWK-7	7.0	
LEDWK-8.5	8.5	
LEDWK-9	9.0	
LEDWK-10	10.0	
LEDWK-11	11.0	
LEDWK-12	12.0	
LEDWK-13	13.0	
LEDWK-14	14.0	
LEDWK-15	15.0	
LEDWK-17	17.0	
LEDWK-23	23.0	

LED間隔柱 LED SPACER SUPPORT

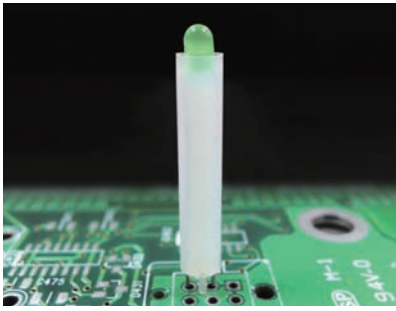

- Material: Nylon 66 (UL)
- Flame Class: 94V-2/94V-0
- Color: Natural/Black
- Unit: mm

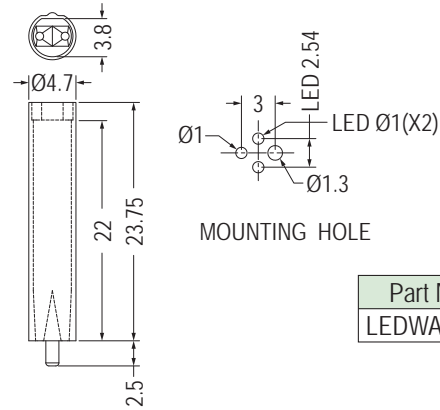

MOUNTING HOLE

Part No.	Package
LEDWA-23.7	1000

用途：用於保護LED焊於PC板上，高度一致，有定位腳，不歪斜。

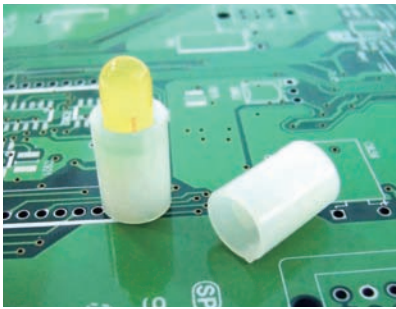

- Material: Nylon 66 (UL)
- Flame Class: 94V-2/94V-0
- Color: Natural/Black
- Unit: mm

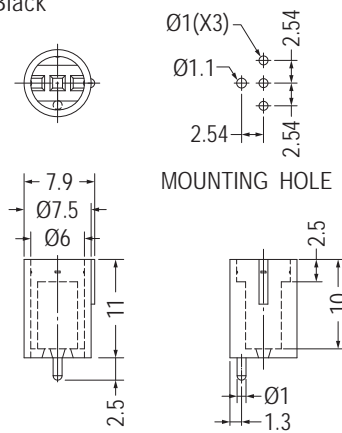

MOUNTING HOLE

Part No.	Package
LECC-8.5	1000

用途：用於保護3 PIN Ø5 mm LED焊於PC板上，高度一致，不斷腳，有定位腳，不歪斜。



- Material: Nylon 66 (UL)
- Flame Class: 94V-2/94V-0
- Color: Natural/Black
- Unit: mm

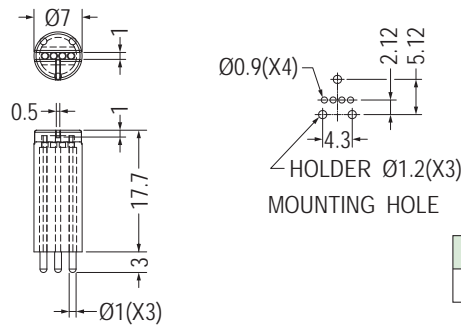

MOUNTING HOLE

Part No.	Package
LEDKB-17.7	1000

用途：用於保護4 PIN Ø5 mm LED焊於PC板上，高度一致，有定位腳，不歪斜。

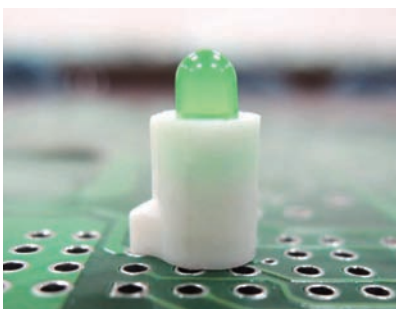

- Material: Nylon 66 (UL)
- Flame Class: 94V-2/94V-0
- Color: Natural/Black
- Unit: mm
- Patented (專利品)

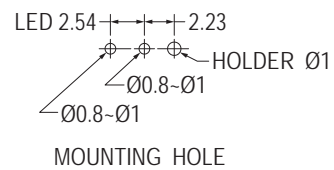
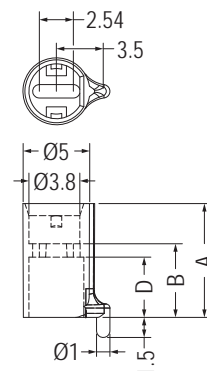

Part No.	A	B	D	Package
LEDXK3-4.5	6.9	4.5	3.5	1000
LEDXK3-5.5	8.5	5.5	4.5	

用途：用於保護2 PIN Ø3 mm LED焊於PC板上，高度一致，有定位腳，不歪斜。

LED間隔柱 LED SPACER SUPPORT

用途：固定LED焊於PC板上，高度一致，有定位腳，不傾斜。

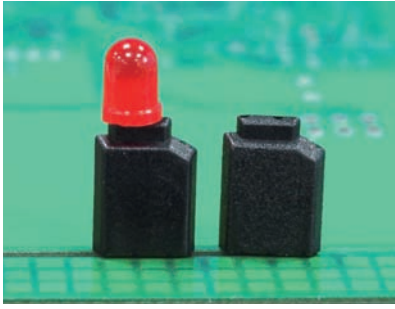

- Material: Nylon 66 (UL)
- Flame Class: 94V-2/94V-0
- Color: Natural/Black
- Unit: mm

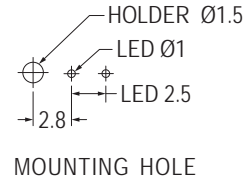
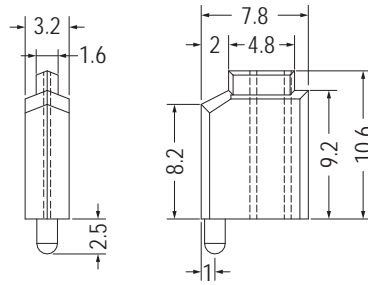

Part No.	Package
LEDR-1	1000

2

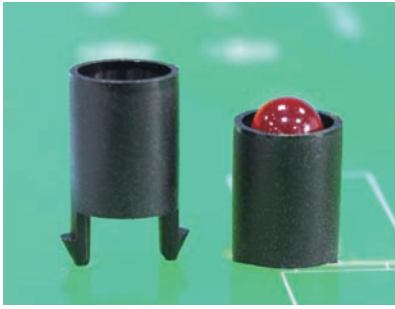

- Material: Nylon 66 (UL)
- Flame Class: 94V-2/94V-0
- Color: Natural/Black
- Unit: mm

用途：可快速將Ø5 mm LED固定於機板上。

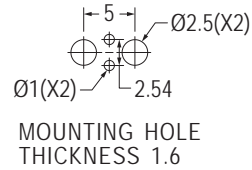
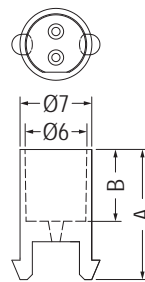

Part No.	A	B	Package
LEKC-5.8	11.0	5.8	2000
LEKC-7	12.7	7.0	



- Material: Nylon 66 (UL)
- Flame Class: 94V-2/94V-0
- Color: Natural/Black
- Unit: mm

用途：使3 PIN Ø5 mm LED固定於PC板上，高度一致，不斷腳。

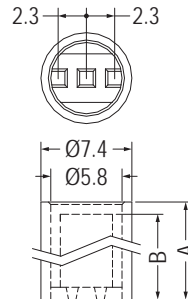

Part No.	A	B	Package
LEDU-4	4.0	3.0	2000
LEDU-6	6.0	5.0	
LEDU-9.5	9.5	8.5	
LEDU-11.5	11.5	10.5	

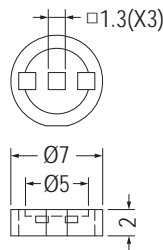
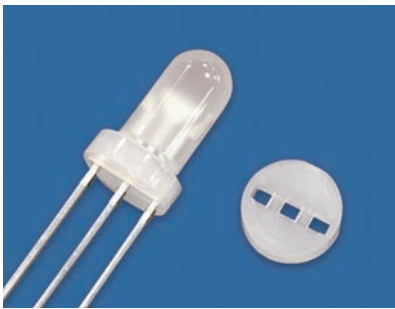

Part No.	Package
LEDU-2	2000

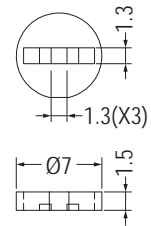

Part No.	Package
LEDU-1.5	2000



- Material: Nylon 66 (UL)
- Flame Class: 94V-2/94V-0
- Color: Natural/Black
- Unit: mm

用途：用於保護Ø3 mm LED立於PC板上，高度一致，接腳不會彎曲、折斷、短路。

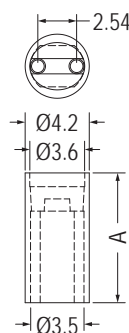

Part No.	A	Package
LEDMU-8.5	8.5	1000
LEDMU-10	10.0	
LEDMU-15	15.0	
LEDMU-20	20.0	

LED間隔柱 LED SPACER SUPPORT

用途：使4 PIN變色LED固定於PC板上，高度一致，不斷腳。

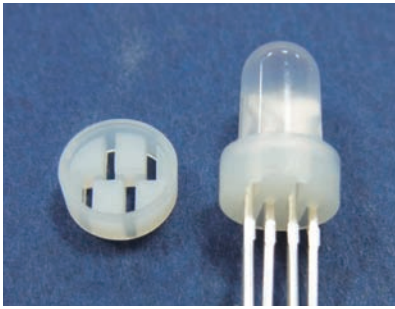

- Material: Nylon 66 (UL)
- Flame Class: 94V-2/94V-0
- Color: Natural/Black
- Unit: mm

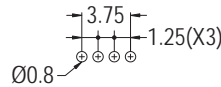

MOUNTING HOLE

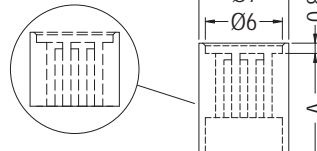

【 LED54-2.5-LED54-5 】

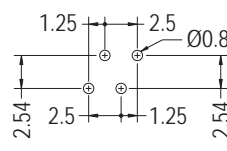

MOUNTING HOLE

Part No.	A	Package
LED54-2	2.0	2000
LED54-2.5	2.5	1000
LED54-3	3.0	
LED54-3.5	3.5	
LED54-4	4.0	
LED54-4.5	4.5	
LED54-5	5.0	
LED54-5.5	5.5	
LED54-6	6.0	
LED54-6.5	6.5	
LED54-7	7.0	
LED54-7.5	7.5	
LED54-8	8.0	
LED54-8.5	8.5	
LED54-9	9.0	
LED54-9.5	9.5	
LED54-10	10.0	

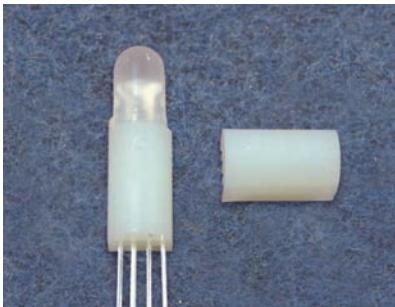

- Material: Nylon 66 (UL)
- Flame Class: 94V-2/94V-0
- Color: Natural/Black
- Unit: mm

用途：使LED立於PC板上，高度一致，不斷腳。

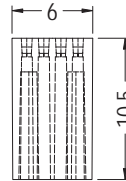

Part No.	Package
LD54-10.5	2000

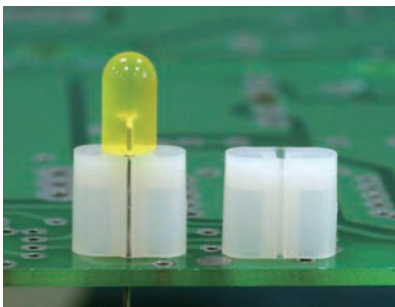

- Material: Nylon 66 (UL)
- Flame Class: 94V-2/94V-0
- Color: Natural/Black
- Unit: mm

用途：可配合LED使用。

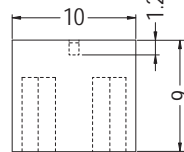
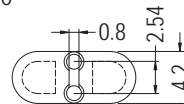

Part No.	Package
LEDMU-9	1000

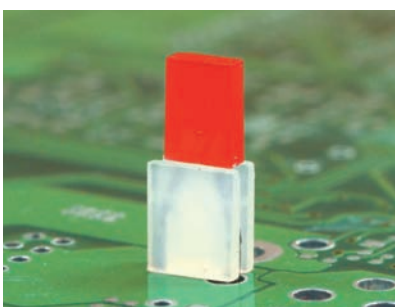

- Material: Nylon 66 (UL)
- Flame Class: 94V-2/94V-0
- Color: Natural/Black
- Unit: mm

用途：保護LED固定於PC板上，使接腳不會彎曲、折斷、短路，並使LED高度一致。

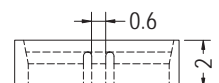
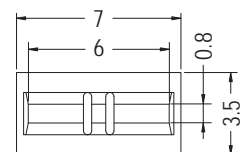
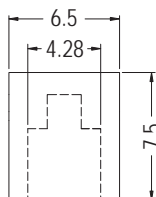

Part No.	Package
LED2X7.5	2000

Part No.	Package
LEDSC-2	1000

LED間隔柱 LED SPACER SUPPORT

用途：保護雙色LED(3 PIN)固定於PC板上，使接腳不會彎曲、折斷、短路，並使LED高度一致。

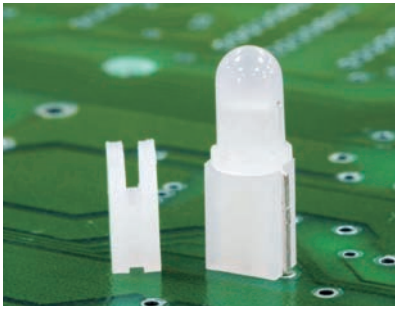

- Material: Nylon 66 (UL)
- Flame Class: 94V-2/94V-0
- Color: Natural/Black
- Unit: mm

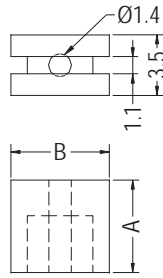

Part No.	A	B	Package
LED3X9	9.0	5.7	1000
LED3X9.5	9.5	5.7	
LED3X10	10.0	5.7	
LED3X10.5	10.5	5.7	
LED3X11	11.0	6.0	
LED3X11.5	11.5	5.7	
LED3X12	12.0	5.7	
LED3X12.5	12.5	5.7	
LED3X13	13.0	5.7	
LED3X13.6	13.5	5.7	
LED3X14	14.0	5.7	
LED3X14.5	14.5	5.7	
LED3X15	15.0	7.0	
LED3X15.5	15.5	5.7	
LED3X16	16.0	5.7	
LED3X16.5	16.5	5.7	
LED3X17	17.0	5.7	
LED3X17.5	17.5	5.7	
LED3X18	18.0	5.7	
LED3X18.5	18.5	5.7	
LED3X19	19.0	5.7	
LED3X19.5	19.5	5.7	
LED3X22	22.0	5.7	

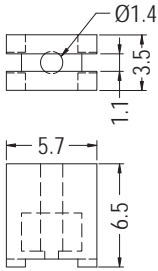

Part No.	A	B	Package
LED3X3	3.0	5.7	2000
LED3X3.5	3.5	5.7	
LED3X4	4.0	5.7	
LED3X4.5	4.5	5.7	
LED3X5	5.0	5.7	
LED3X5.5	5.5	5.7	
LED3X6	6.0	5.7	
LED3X6.5	6.5	5.7	
LED3X7	7.0	5.7	
LED3X7.5	7.5	5.7	
LED3X8	8.0	5.7	
LED3X8.5	8.5	5.7	

- Material: Nylon 6T (UL)
- Flame Class: 94V-0
- Color: Natural

Part No.	Package
LED3X6-1	2000

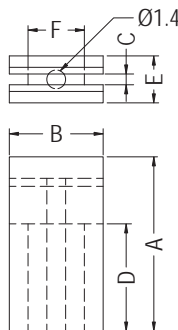

Part No.	A	B	C	D	E	F	Package
LED3X13-1	13.0	7.0	0.8	8.0	3.5	4.2	1000
LED3X16-1	16.0	6.0	0.9	11.5	3.9	4.3	

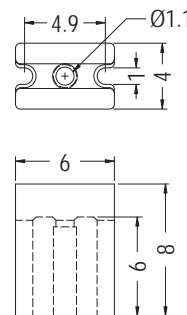

Part No.	Package
LED3X8R	2000

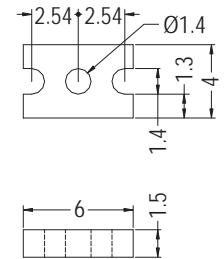

Part No.	Package
LED3X1.5R	2000



- Material: Nylon 66 (UL)
- Flame Class: 94V-2/94V-0
- Color: Natural/Black
- Unit: mm

用途：用於3 PIN LED之墊高及固定，有定位腳，不歪斜。

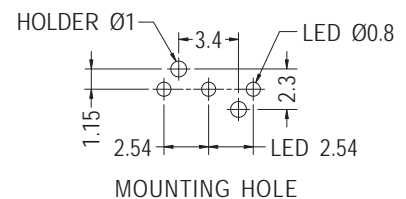
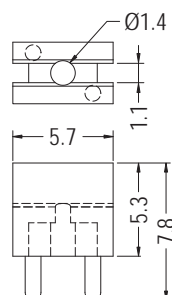

Part No.	Package
LEK3X5.3	1000

LED間隔柱 LED SPACER SUPPORT



- Material: Nylon 46 (UL)
- Flame Class: 94V-0
- Color: Black
- Unit: mm

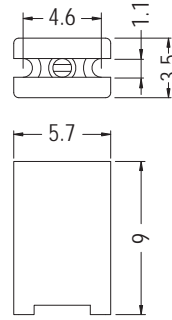

用途：保護LED固定於PC板上，使接腳不會彎曲、折斷、短路，並使LED高度一致。

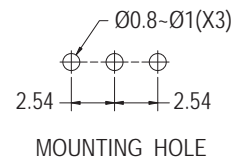

Part No.	Package
LED3A-9	1000

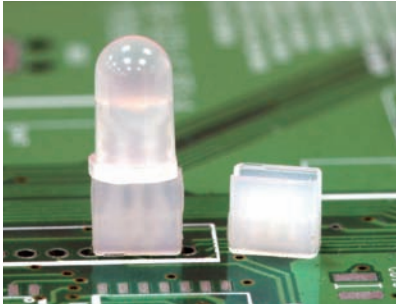

- Material: Nylon 66 (UL)
- Flame Class: 94V-2/94V-0
- Color: Natural/Black
- Unit: mm

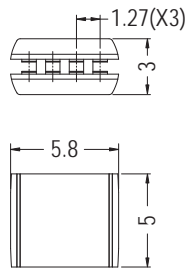

Part No.	Package
LED4AX5	2000

用途：保護4 PIN LED固定於PC板上，使接腳不會彎曲、折斷、短路，並使LED高度一致。

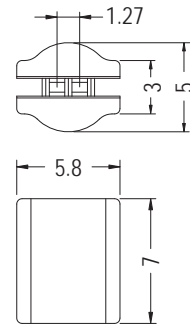

Part No.	Package
LED4X7	2000

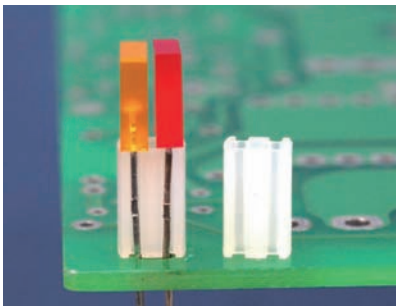

- Material: Nylon 66 (UL)
- Flame Class: 94V-2/94V-0
- Color: Natural/Black
- Unit: mm

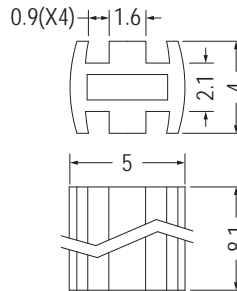

Part No.	Package
LED-208	2000

用途：使LED固定於PC板上，高度一致，不斷腳。可用於2個方形LED燈並排。

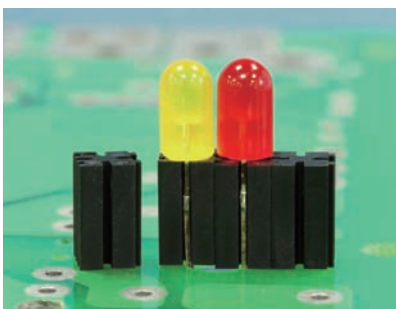

- Material: Nylon 66 (UL)
- Flame Class: 94V-2/94V-0
- Color: Natural/Black
- Unit: mm

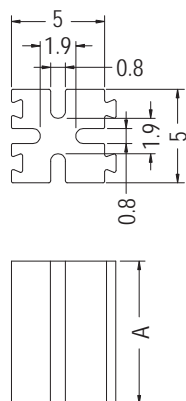

Part No.	A	Package
LEDP-3	3.0	2000
LEDP-4	4.0	
LEDP-5	5.0	
LEDP-6	6.0	
LEDP-7	7.0	
LEDP-8	8.0	
LEDP-9	9.0	
LEDP-9.5	9.5	
LEDP-10	10.0	

Part No.	A	Package
LEDP-11	11.0	2000
LEDP-12	12.0	
LEDP-13	13.0	
LEDP-14	14.0	
LEDP-15	15.0	
LEDP-16	16.0	
LEDP-17	17.0	
LEDP-18	18.0	
LEDP-19	19.0	
LEDP-20	20.0	

用途：保護LED固定於PC板上，使接腳不會彎曲、折斷、短路，可連接多個LED座，並使LED高度一致。

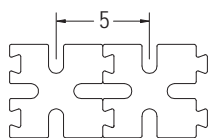

- 產品可組合使用
- Products are combinable

LED間隔柱 LED SPACER SUPPORT

用途：使LED固定於PC板上，高度一致，不斷腳。

- Material: Nylon 66 (UL)
- Flame Class: 94V-2/94V-0
- Color: Natural/Black
- Unit: mm

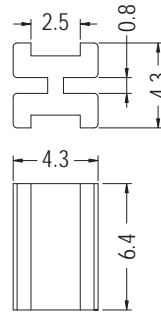
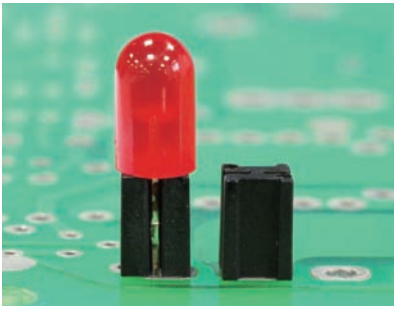

Part No.	Package
LEDP3-6.4	500

2

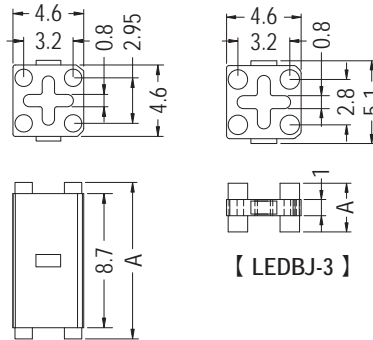
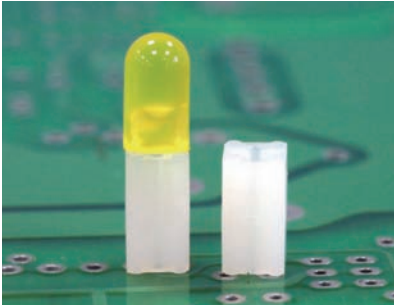

Part No.	A	Package
LEDBJ-3	3.0	2000
LEDBJ-9	9.15	1000
LEDBJ10	10.15	

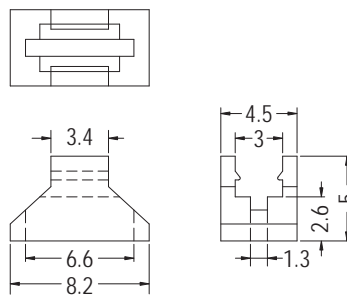
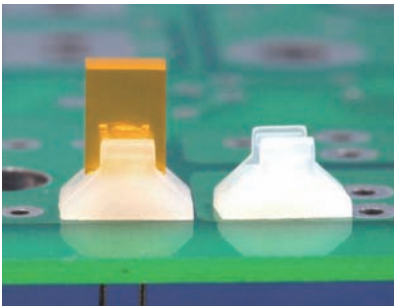

Part No.	Package
LEC-1	2000

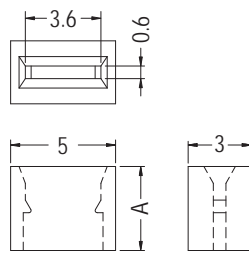
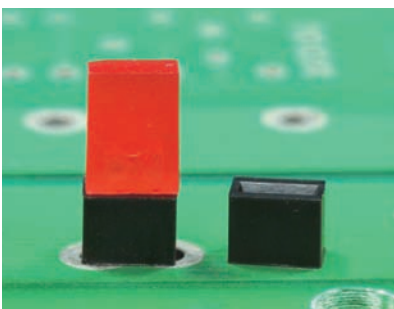

Part No.	A	Package
LEDJ-4	4.0	2000
LEDJ-4.5	4.5	

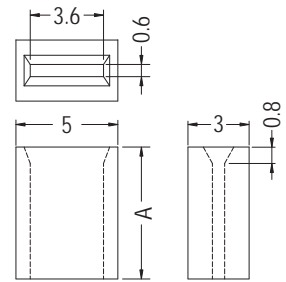

Part No.	A	Package
LEDJ-7.5	7.5	2000
LEDJ-8	8.0	
LEDJ-8.5	8.5	

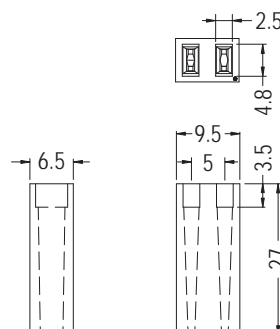
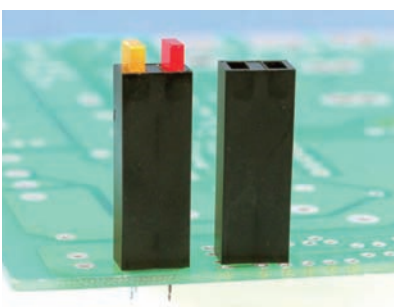

Part No.	Package
ELH2-27	500

LED間隔柱 LED SPACER SUPPORT

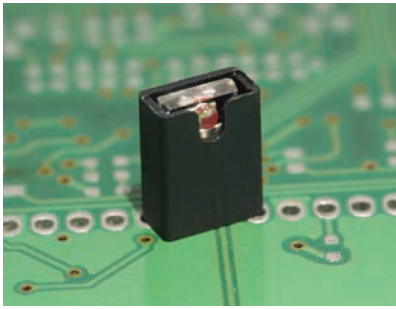

- Material: Nylon 66 (UL)
- Flame Class: 94V-2/94V-0
- Color: Black
- Unit: mm

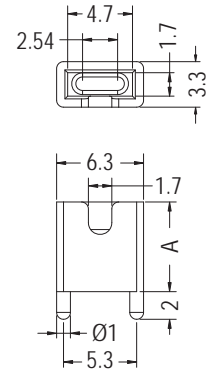
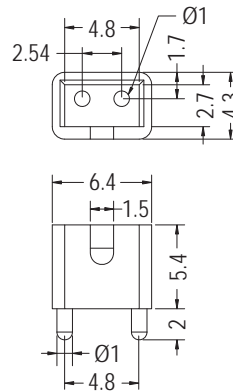

Part No.	Package
LEDUA-5.4	2000

Part No.	A	Package
LEDUA-6.5	6.5	2000
LEDUA-8	8.0	2000

用途：使LED固定於PC板上，高度一致，不斷腳。

LED蓋 LED CAP

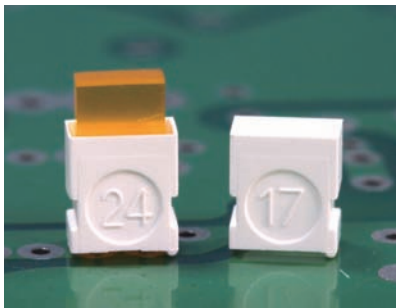

- Material: PC (UL)
- Flame Class: 94V-2/94V-0
- Color: Natural/White
- Unit: mm

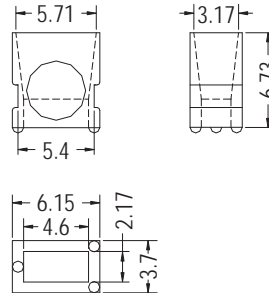

Part No.	Package
ELED-1	2000

用途：做為LED外殼。

LED座 LED HOLDER

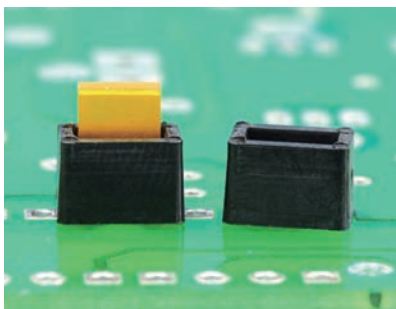

- Material: Nylon 66 (UL)
- Flame Class: 94V-2/94V-0
- Color: Black
- Unit: mm
- Patented (專利品)

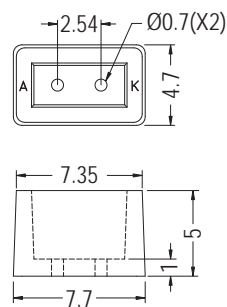

Part No.	Package
LEF-1	2000

用途：保護LED固定PC板上，使接腳不會彎曲、折斷、短路，並使LED高度一致。

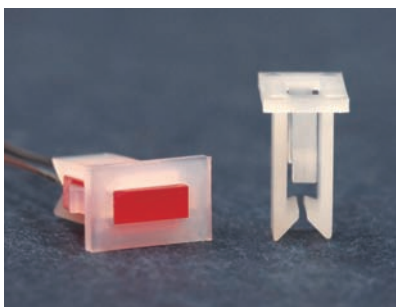

- Material: Nylon 66 (UL)
- Flame Class: 94V-2/94V-0
- Color: Natural/Black
- Unit: mm

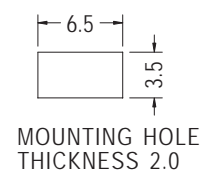
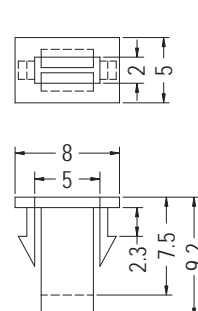

Part No.	Package
LEQ-1	2000

用途：可快速將5X2方形LED固定於機器面板上。

LED座 LED HOLDER

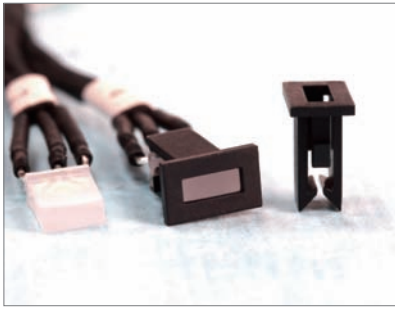

- Material: Nylon 66 (UL)
- Flame Class: 94V-2/94V-0
- Color: Natural/Black
- Unit: mm
- Patented (專利品)

用途：可快速將5X2方形LED固定於機器面板上。

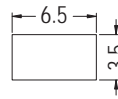
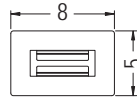

MOUNTING HOLE
THICKNESS 1.0

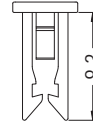
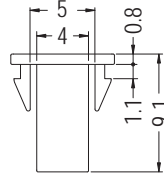

Part No.	Package
LEQ-3	2000

LED座套 LED HOLDER COVER



- Material: Nylon 66 (UL)
- Flame Class: 94V-2/94V-0
- Color: Black
- Unit: mm

用途：可將方形LED固定於機器面板上，與LEQ-2T配合使用。

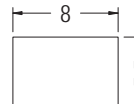
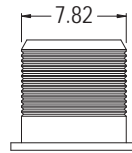

MOUNTING HOLE

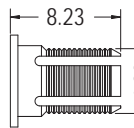
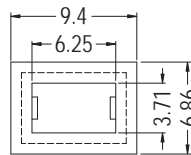

Part No.	Package
LEQ-2	1000



- Material: Nylon 66 (UL)
- Flame Class: 94V-2/94V-0
- Color: Black
- Unit: mm

用途：可配合加強LEQ-2固定於機器面板上不脫落。

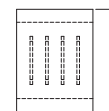
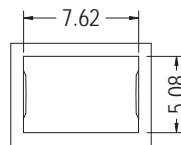
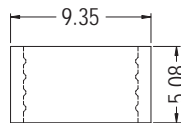

Part No.	Package
LEQ-2T	1000

LED間隔柱 LED SPACER SUPPORT



- Material: Nylon 66 (UL)
- Flame Class: 94V-2/94V-0
- Color: Natural/Black
- Unit: mm

用途：可配合LED定位。

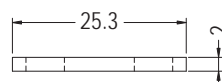
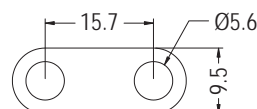

Part No.	Package
PUCP-1	1000

LED間隔柱 LED SPACER SUPPORT

用途：可配合LED定位。

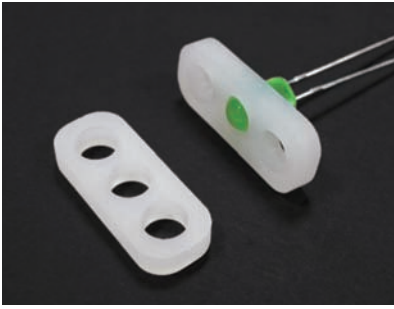

- Material: Nylon 66 (UL)
- Flame Class: 94V-2/94V-0
- Color: Natural/Black
- Unit: mm

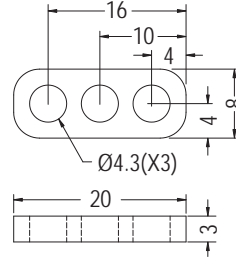

Part No.	Package
LEDI3-3	1000



- Material: Nylon 66 (UL)
- Flame Class: 94V-2/94V-0
- Color: Black
- Unit: mm

用途：LED墊高，可固定間隔，長度可自行裁切。

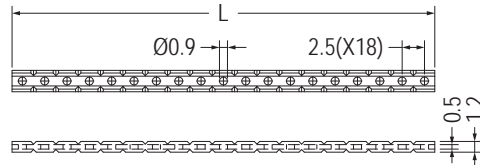

Part No.	L	Package
EM-45	47.3	500
EM-45-2	4.9	
EM-45-3	7.4	
EM-45-4	9.9	
EM-45-5	12.4	
EM-45-6	14.9	
EM-45-7	17.4	
EM-45-8	19.9	

Part No.	L	Package
EM-45-9	22.4	500
EM-45-10	24.9	
EM-45-11	27.4	
EM-45-12	29.9	
EM-45-13	32.4	
EM-45-14	34.9	
EM-45-15	37.4	
EM-45-16	39.9	
EM-45-17	42.4	

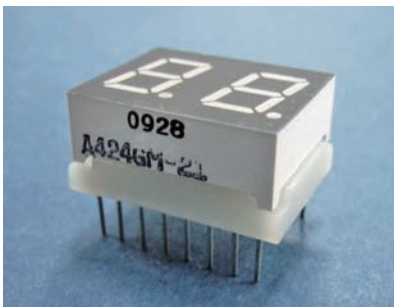

- Material: Nylon 66 (UL)
- Flame Class: 94V-2/94V-0
- Color: Natural/Black
- Unit: mm

用途：可快速將8字型LED固定墊高於PC板上。

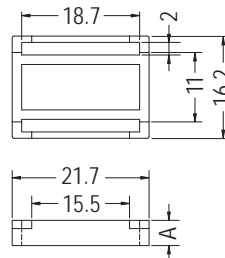

Part No.	A	Package
LEDSS-4	4.0	1000
LEDSS-5	5.0	
LEDSS-6	6.0	
LEDSS-7	7.0	
LEDSS-8	8.0	

LED座 LED HOLDER

用途：可快速將Ø3 mm LED固定於機器面板上，LED3-1B可加強LED3-2之固定或作為墊片使用。



- Material: Nylon 66 (UL)
- Flame Class: 94V-2/94V-0
- Color: Black
- Unit: mm

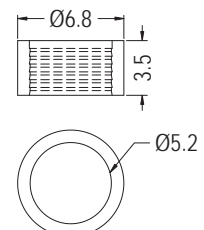
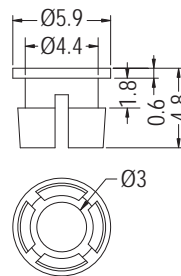

MOUNTING HOLE Ø4.5
THICKNESS 1.7

Part No.	Package
LED3-2	2000

Part No.	Package
LED3-1B	2000

LED座 LED HOLDER

用途：可快速將Ø3 mm LED固定於機器面板上。



- Material: Nylon 66 (UL)
- Flame Class: 94V-2/94V-0
- Color: Black
- Unit: mm

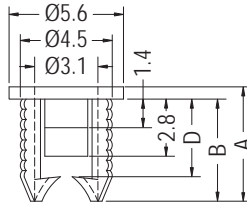

CHASSIS Ø4.5
THICKNESS 0.8-1.2

Part No.	A	B	D	Package
LED3-1	5.6	5.0	3.8	2000
LED3-8	4.6	4.0	2.8	

2

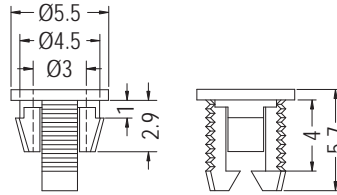

CHASSIS Ø4.5
THICKNESS 0.8

Part No.	Package
LED3-4	2000

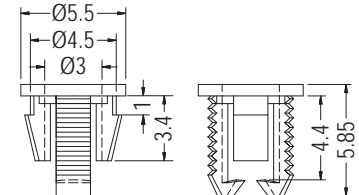

CHASSIS Ø4.5
THICKNESS 1.0

Part No.	Package
LED3-20	2000

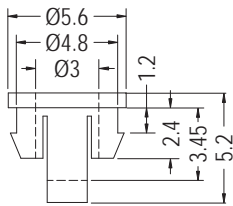

CHASSIS Ø5.0
THICKNESS 1.0~1.1

Part No.	Package
LED3-5	2000

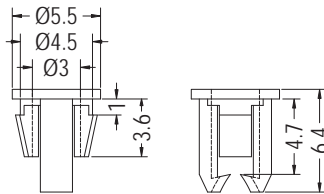

CHASSIS Ø4.5
THICKNESS 0.8

Part No.	Package
LED3-6	2000

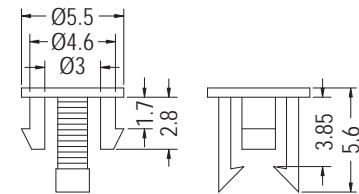

CHASSIS Ø4.5
THICKNESS 1.6

Part No.	Package
LED3-7	2000

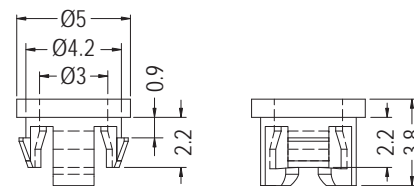

CHASSIS Ø4.3
THICKNESS 0.8

Part No.	Package
LED3-29	2000

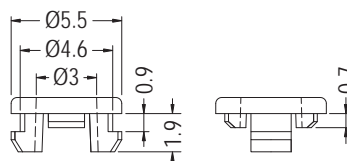
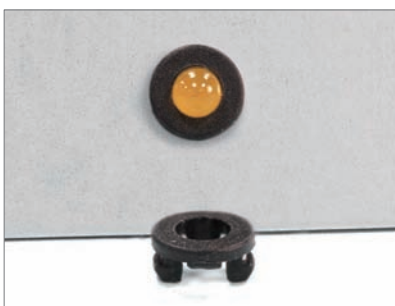

CHASSIS Ø4.8
THICKNESS 0.8

Part No.	Package
LED3-23	2000

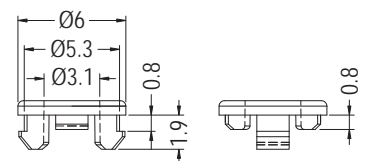

CHASSIS Ø5.3
THICKNESS 0.8

Part No.	Package
LED3-34	2000

LED座 LED HOLDER

用途：可快速將 $\varnothing 3$ mm LED固定於機器面板上。



- Material: Nylon 66 (UL)
- Flame Class: 94V-2/94V-0
- Color: Black
- Unit: mm

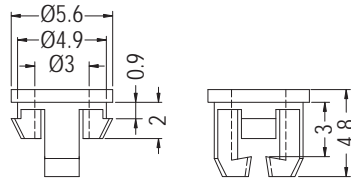

CHASSIS $\varnothing 5.0$
THICKNESS 0.8

Part No.	Package
LED3-22	1000

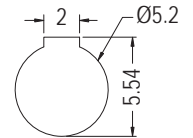

HOLE IN CHASSIS
THICKNESS 0.8

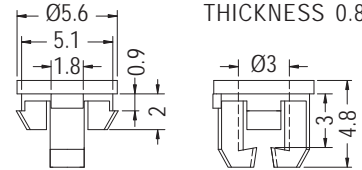

Part No.	Package
LED3-28	2000

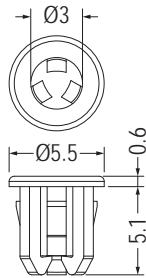

MOUNTING HOLE $\varnothing 4.3$
THICKNESS 0.7

Part No.	Package
★LED3-61	1000

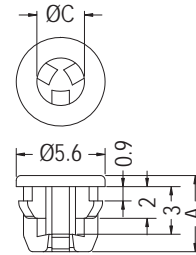

MOUNTING HOLE $\varnothing 5.0$
CHASSIS THICKNESS 0.8

• Patented (專利品)

Part No.	A	C	Package
LED3-37	4.8	3.0	2000
LED3-38	4.8	2.8	
LED3-44	5.3	3.0	

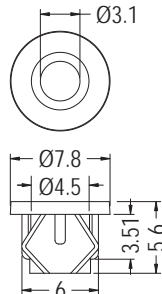

MOUNTING HOLE $\varnothing 6.35$
THICKNESS 2.0

Part No.	Package
LED3-19	1000

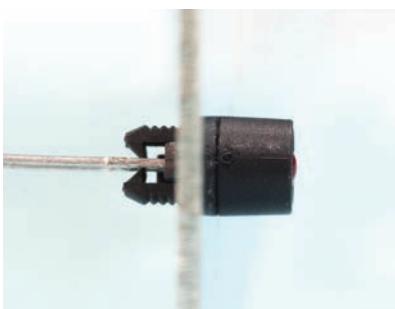

- Material: Nylon 66 (UL)
- Flame Class: 94V-2/94V-0
- Color: Black
- Unit: mm

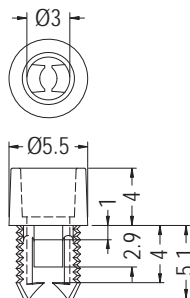

MOUNTING HOLE $\varnothing 4.5$
THICKNESS 0.8

Part No.	Package
LED3-45	1000

用途：可快速將 $\varnothing 3$ mm LED燈固定於機器面板上，有遮光，不干涉。

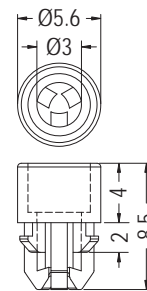

MOUNTING HOLE $\varnothing 5.0$
THICKNESS 0.8

• Patented (專利品)

Part No.	Package
LED3-46	1000

LED座 LED HOLDER

用途：可快速將 $\varnothing 3$ mm LED固定於機器面板上。



- Material: PC (UL)
- Flame Class: 94V-2
- Color: Black
- Unit: mm

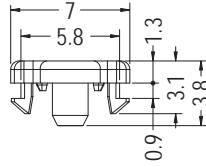
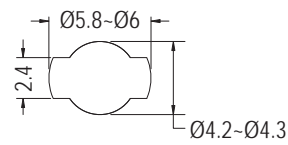
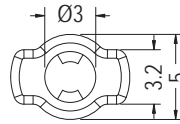

MOUNTING HOLE
THICKNESS 0.8

Part No.	Package
LED3-53	1000

2

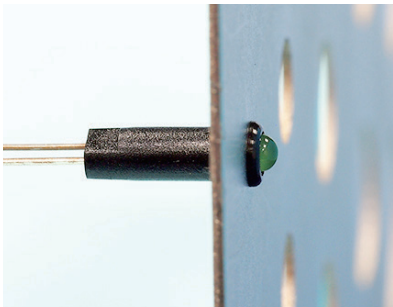

- Material: Nylon 66 (UL)
- Flame Class: 94V-2/94V-0
- Color: Black
- Unit: mm

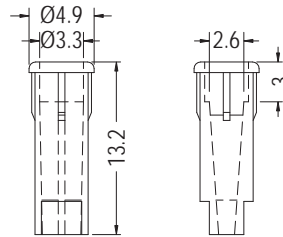

CHASSIS $\varnothing 4.5$

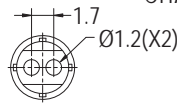

Part No.	Package
LED3-3	2000



- Material: Nylon 66 (UL)
- Flame Class: 94V-2/94V-0
- Color: Natural/Black
- Unit: mm

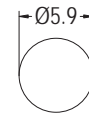
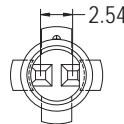

MOUNTING HOLE
THICKNESS 0.6-0.8

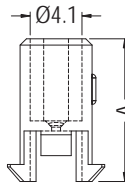
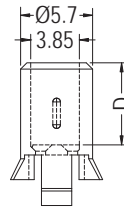

Part No.	A	D	Package
LEQU3-1	12.8	8.0	2000
LEQU3-2	11.3	6.5	



- Material: Nylon 66 (UL)
- Flame Class: 94V-2/94V-0
- Color: Black
- Unit: mm

用途：可快速將 $\varnothing 5$ mm LED固定於機器面板上。

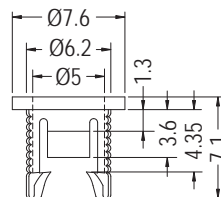

MOUNTING HOLE $\varnothing 6.4$
THICKNESS 1.2

Part No.	Package
LED5-1	2000

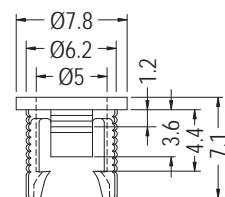

CHASSIS $\varnothing 6.4$
THICKNESS 1.2

Part No.	Package
LED5-1S	2000

LED座 LED HOLDER



- Material: Nylon 66 (UL)
- Flame Class: 94V-2/94V-0
- Color: Black
- Unit: mm

用途：可快速將 $\varnothing 5$ mm LED固定於機器面板上，LED5-5T可加強LED5-5之固定或作為墊片使用。

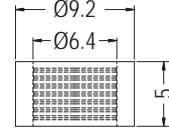
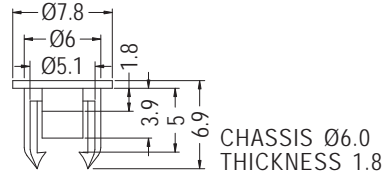
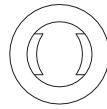

Part No.	Package
LED5-5	2000

Part No.	Package
LED5-5T	2000

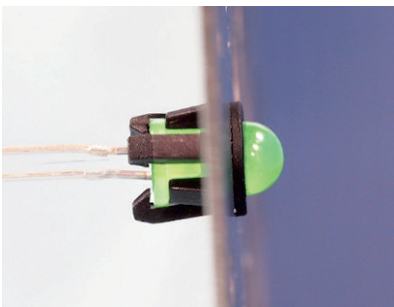

- Material: Nylon 66 (UL)
- Flame Class: 94V-2/94V-0
- Color: Black
- Unit: mm
- Patented (專利品)

用途：可快速將LED固定於機器面板上。

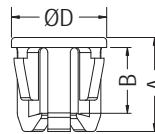

MOUNTING HOLE $\varnothing 7.0$
THICKNESS: T

Part No.	A	B	C	D	T	Package
LED5-28	7.5	5.5	4.9	7.6	0.6-0.8	1000
LED5-29	6.9	4.65	5.0	8.0	0.8	



- Material: Nylon 66 (UL)
- Flame Class: 94V-2/94V-0
- Color: Black
- Unit: mm

用途：可快速將橢圓LED固定於機器面板上。

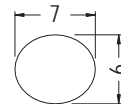
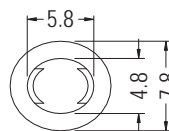

MOUNTING HOLE
THICKNESS 1.0

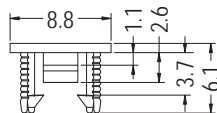

Part No.	Package
LED5-6	2000

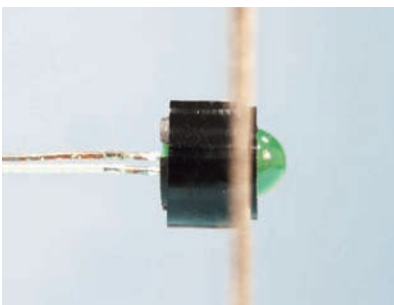

- Material: Nylon 66 (UL)
- Flame Class: 94V-2/94V-0
- Color: Black
- Unit: mm

用途：可快速將 $\varnothing 5$ mm LED固定於機器面板上。LED5-2B可加強LED5-2之固定或作為墊片使用。

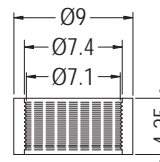
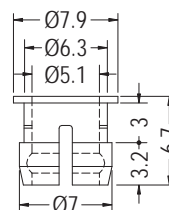

CHASSIS $\varnothing 6.4$
THICKNESS 3.0

【 LED5-2A 】

【 LED5-2B 】

Part No.	Package
LED5-2	1000

LED座套 LED HOLDER COVER

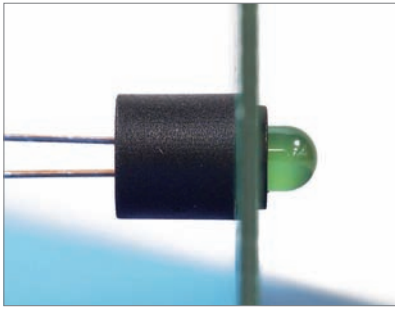

- Material: Nylon 66 (UL)
- Flame Class: 94V-2/94V-0
- Color: Black
- Unit: mm

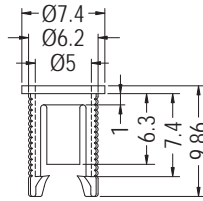

CHASSIS Ø6.35
THICKNESS 0.9

Part No.	Package
LED5-8	2000

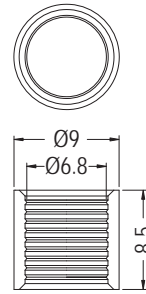

Part No.	Package
LED5-8T	2000

用途：可快速將Ø5 mm LED固定於機器面板上。LED5-8T可加強LED5-8之固定，或作為墊片使用。

LED套 LED HOLDER COVER



- Material: Nylon 66 (UL)
- Flame Class: 94V-2/94V-0
- Color: Black
- Unit: mm

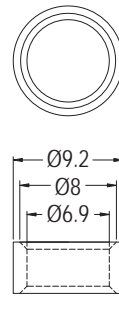

Part No.	Package
LED5-27T	2000

用途：可快速將Ø5 mm LED固定於機器面板上，或作為墊片使用。

LED座 LED HOLDER

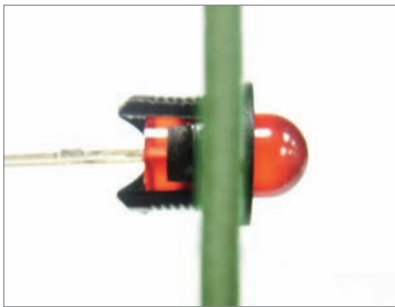

- Material: Nylon 66 (UL)
- Flame Class: 94V-2/94V-0
- Color: Black
- Unit: mm

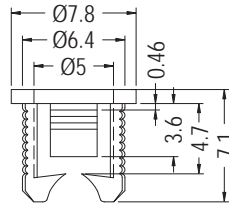

CHASSIS Ø6.5
THICKNESS 0.6~1.2

Part No.	Package
LED5-16S	2000

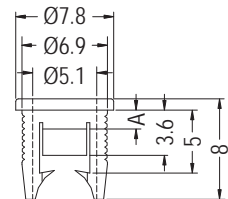

CHASSIS Ø7.0
THICKNESS: T

Part No.	A	T	Package
LED5-9	1.5	0.8~1.4	1000
LED5-9S	1.0	0.8	2000

用途：可快速將Ø5 mm LED固定於機器面板上。

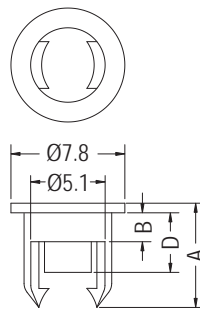
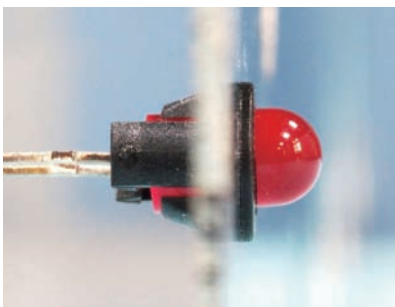

CHASSIS: ØG
THICKNESS: T

Part No.	A	B	D	G	T	Package
LED5-11	6.3	1.1	3.3	6.0	0.8~1.0	2000
LED5-13	6.9	1.8	3.9	6.2	1.2~1.6	

LED座 LED HOLDER

用途：可快速將 $\varnothing 5$ mm LED固定於機器面板上。



- Material: Nylon 66 (UL)
- Flame Class: 94V-2/94V-0
- Color: Black
- Unit: mm

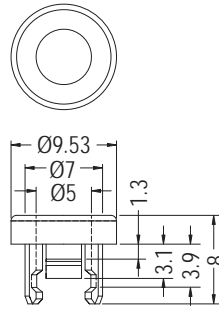

CHASSIS $\varnothing 7.2$
THICKNESS 1.2

Part No.	Package
LED5-25	500

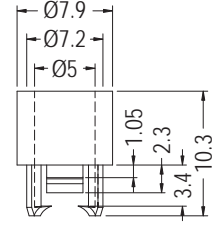

CHASSIS $\varnothing 6.5$
THICKNESS 0.8-1.0

Part No.	Package
LED5-14	2000

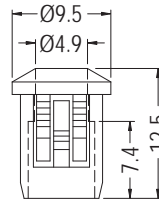
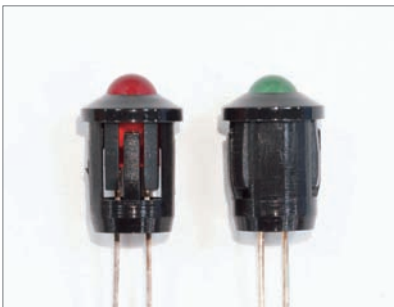

CHASSIS $\varnothing 8.0$
THICKNESS 1.2-3.0

Part No.	Package
LED5-3	1000

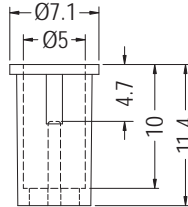

CHASSIS $\varnothing 6.35$
THICKNESS 0.8-1.4

Part No.	Package
LED5-4	1000

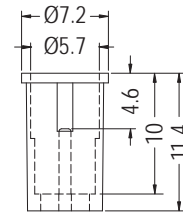

CHASSIS $\varnothing 6.4$
THICKNESS 0.8-1.4

Part No.	Package
LED5-10	1000



- Material: Nylon 66 (UL)
- Flame Class: 94V-2/94V-0
- Color: Black
- Unit: mm

用途：可快速將LED固定於機器面板上。

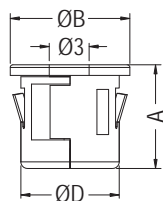

CHASSIS: $\varnothing G$
THICKNESS: T

• 適用 $\varnothing 3$ LED帽緣款

Part No.	A	B	D	G	T	Suitable LED	Package
LED3-14	7.8	9.0	7.4	7.5	0.6-1.0	3 PIN	1000
LED3-14M	7.8	9.0	7.4	7.5	1.0-1.2	3 PIN	
LED3-15	6.5	7.2	6.3	6.4	0.6-1.0	2 PIN	
LED3-15M	6.5	7.2	6.3	6.4	1.0-1.2	2 PIN	

LED座 LED HOLDER

用途：可快速將LED固定於機器面板上。



- Material: Nylon 66 (UL)
- Flame Class: 94V-2/94V-0
- Color: Black
- Unit: mm

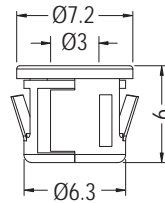

CHASSIS Ø6.35~Ø6.4
THICKNESS 0.8

Part No.	Package
LED3-33	1000

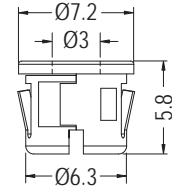

CHASSIS Ø6.35
THICKNESS: T

- 適用Ø3 LED帽緣款
- 適用於2 PIN、3PIN

Part No.	T	Package
LED3-16	0.6~1.0	1000
LED3-16M	1.0~1.2	

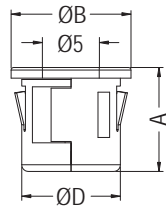

CHASSIS: ØG
THICKNESS: T

- 適用Ø5 LED帽緣款

Part No.	A	B	D	G	T	Suitable LED	Package
LED5-17	10.9	10.5	8.8	9.0	0.6~1.0	3 PIN	1000
LED5-17M	10.9	10.5	8.8	9.0	1.0~1.2	3 PIN	
LED5-18	9.5	9.0	7.4	7.5	0.6~1.0	2 PIN	
LED5-18M	9.5	9.0	7.4	7.5	1.0~1.2	2 PIN	
LED5-18L	9.5	9.0	7.4	7.6	1.5	2 PIN	

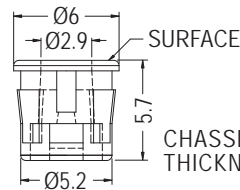

CHASSIS Ø5.2
THICKNESS 0.8~1.0

- 適用Ø3 LED帽緣款
- 適用於2 PIN

Part No.	Surface	Package
LED3-17	Matte	1000
LED3-35	Glossy	

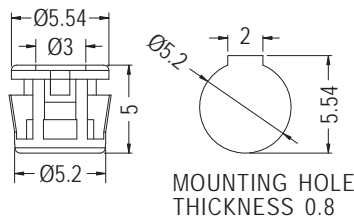

MOUNTING HOLE
THICKNESS 0.8

- 適用Ø3 LED帽緣款
- 適用於2 PIN、3 PIN

Part No.	Package
LED3-25	1000

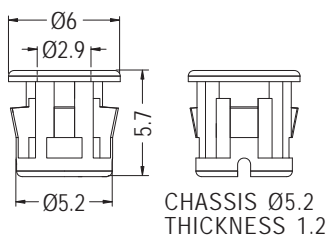

CHASSIS Ø5.2
THICKNESS 1.2

Part No.	Package
LED3-24	1000

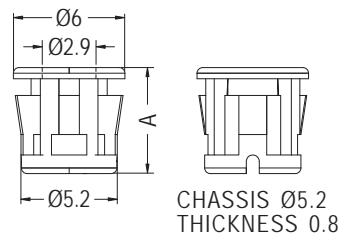

CHASSIS Ø5.2
THICKNESS 0.8

- 適用Ø3 LED帽緣款
- 適用於2 PIN、3 PIN

Part No.	A	Package
LED3-18	5.7	1000
LED3-43	5.5	
LED3-55	4.4	

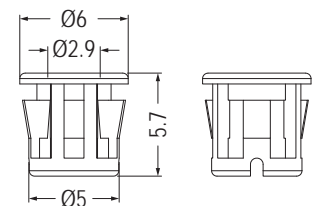

MOUNTING HOLE Ø5.2
THICKNESS 0.8

- Patented (專利品)
- 適用Ø3 LED帽緣款
- 適用於2 PIN、3 PIN

Part No.	Package
LED3-59	1000

LED座 LED HOLDER

用途：可快速將LED固定於機器面板上。

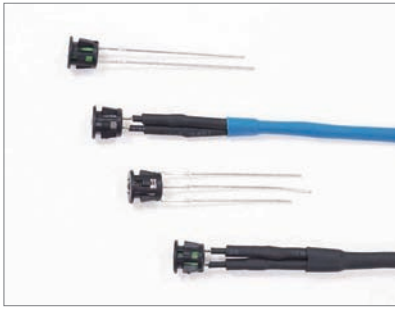

- Material: Nylon 66 (UL)
- Flame Class: 94V-2/94V-0
- Color: Black
- Unit: mm
- Patented (專利品)

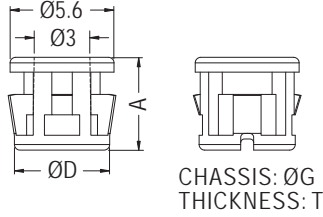

- 適用Ø3 LED帽緣款
- 適用於2 PIN、3 PIN

Part No.	A	D	G	T	Package
LED3-30	5.0	5.2	5.2	1.1	1000
LED3-31	5.2	4.95	5.0	0.8	

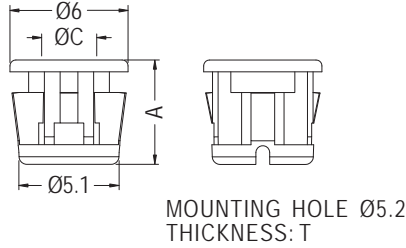

- 適用於2 PIN、3 PIN

Part No.	A	C	T	適用LED帽緣款	Package
LED3-40	5.3	2.8	0.8~1.0	Ø2.8	1000
LED3-40S	5.3	2.8	0.8	Ø2.8	
LED3-41	5.3	2.8	1.2	Ø2.8	
LED3-42	5.7	2.95	0.8~1.0	Ø3.0	

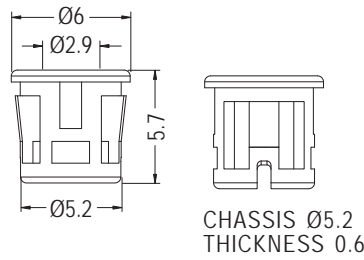

- 適用Ø3 LED帽緣款
- 適用於2 PIN、3 PIN

Part No.	Package
LED3-17-0.6	1000



- Material: Nylon 66 (UL)
- Flame Class: 94V-2/94V-0
- Color: Black
- Unit: mm

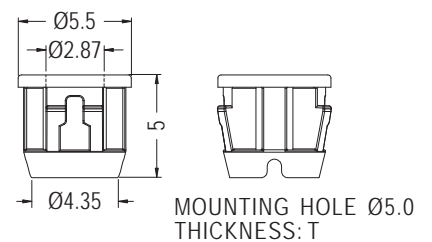
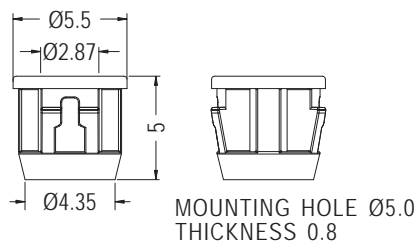

- 適用Ø2.8 LED帽緣款
- 適用於2 PIN

Part No.	Package
LED3-49	1000

- 適用Ø2.8 LED帽緣款
- 適用於2 PIN、3 PIN

Part No.	T	Package
LED3-50	0.8	1000
LED3-50L	1.1	

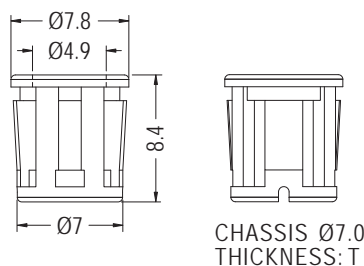

- Patented (專利品)
- 適用Ø5 LED帽緣款
- 適用於2 PIN、3 PIN

Part No.	T	Package
LED5-24	0.8	1000
LED5-24M	1.2	
LED5-24L	1.6	

LED套 LED COVER

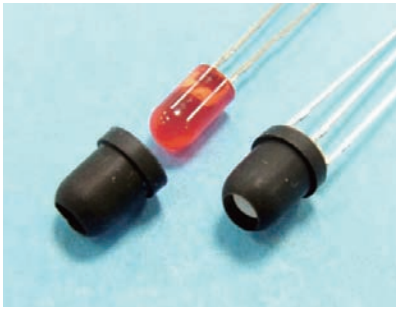

- Material: Silicon Rubber
- Color: Black
- Unit: mm

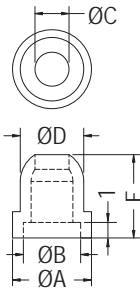

- 適用Ø3 LED、Ø5 LED
- 適用於2 PIN、3 PIN

Part No.	A	B	C	D	E	Package
LEDMK-3	5.1	3.7	2.2	4.1	5.4	2000
LEDMK-5	7.1	5.7	4.0	6.1	8.55	

LED座 LED HOLDER



- Material: Silicon Rubber
- Color: Black
- Unit: mm

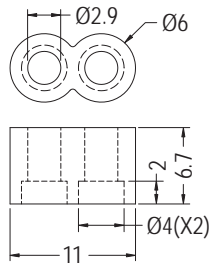

Part No.	Package
LEDMK-1	2000

用途：用於LED的遮光。

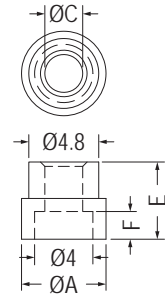

Part No.	A	C	E	F	Package
TF-263	5.8	2.6	5.3	1.9	2000
TF-444	6.0	2.8	5.45	1.3	



- Body Material: PC (UL)
- Flame Class: 94V-2
- Color: Transparent/Natural
- Unit: mm

用途：快速固定Ø3 mm LED於面板上，須搭配M-6螺帽使用，可當電源指示燈。

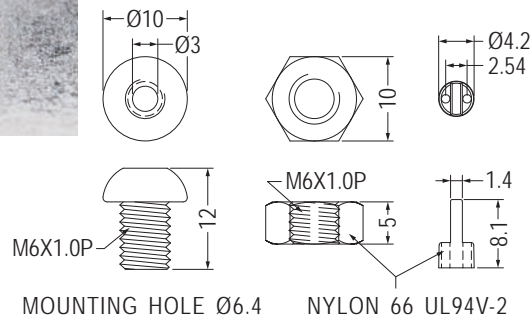

MOUNTING HOLE Ø6.4

NYLON 66 UL94V-2

(BODY) (NUT) (LED SPACER SUPPORT)
【LELG-1A】 【M-6】 【LELG-1B】

Part No.	Part No.	Package
LELG-1F	LELG-1A	2000
	LELG-1B	
	M-6	
子母包：內容物包含右方零件 上述零件亦可單獨選購		



- Material: Nylon 66 (UL)
- Flame Class: 94V-2/94V-0
- Color: Black
- Unit: mm

用途：可快速將LED固定於機器面板上。

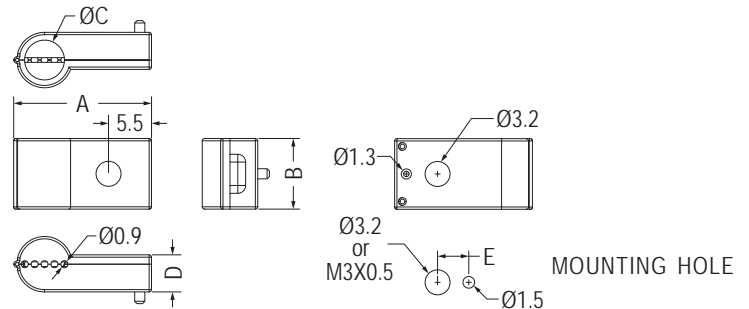

- 適用於2 PIN、3 PIN

Part No.	A	B	C	D	E	適用LED 帽線款	Package
LEKHD-1	17.65	9.05	5.1	4.75	4.0	Ø5	1000
LEKHD-2	14.05	6.0	3.1	4.25	3.0	Ø3	

LED座 LED HOLDER



- Material: Nylon 66 (UL)
- Flame Class: 94V-2/94V-0
- Color: Black
- Unit: mm
- Patented (專利品)

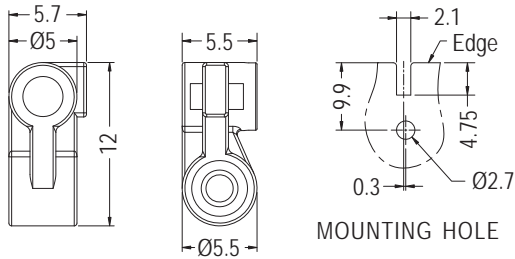

Part No.	Package
LEKHA-1	1000

用途：可快速將Ø3 mm LED燈固定於機器面板上，有遮光，不干涉。

LED固定座 LED MOUNT

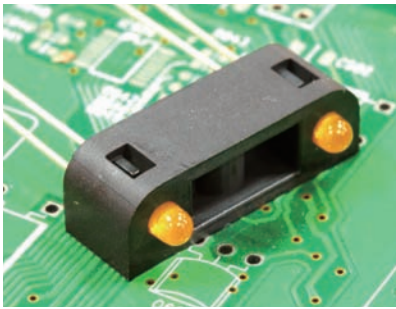

- Material: Nylon 66 (UL)
- Flame Class: 94V-2/94V-0
- Color: Black
- Unit: mm

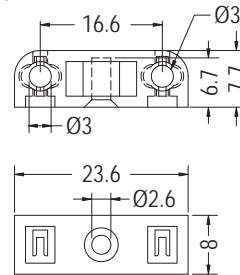

Part No.	Package
EMD-141	1000

用途：配合螺絲，可將2 PIN、3 PIN Ø3 LED固定於機板上。



- Material: Nylon 66 (UL)
- Flame Class: 94V-2/94V-0
- Color: Black
- Unit: mm

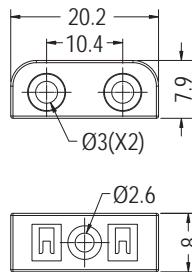

Part No.	Package
LED3-47	1000

用途：配合螺絲，可將LED固定於機板上。

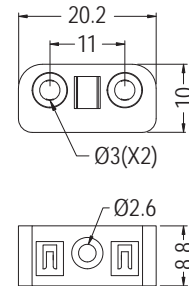

Part No.	Package
LED3-48	1000



- Material: Nylon 66 (UL)
- Flame Class: 94V-2/94V-0
- Color: Black
- Unit: mm
- Patented (專利品)

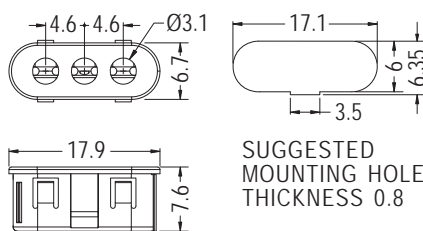

Part No.	Package
LED3-14-3S	1000

用途：可快速將LED固定於機器面板上。

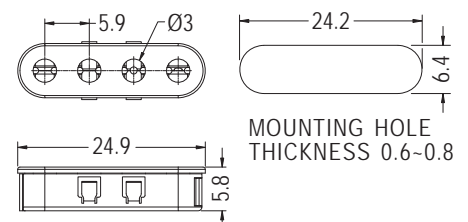

Part No.	Package
LED3-14-4S	1000

LED導光柱 LIGHT PIPE

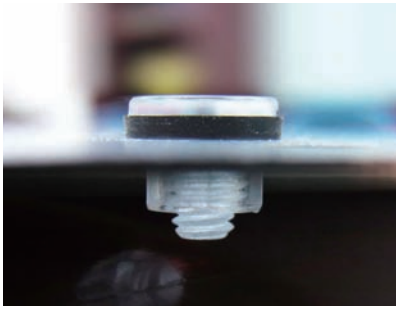

- Material: PC (UL)
- Flame Class: 94V-2
- Color: Transparent
- Unit: mm

用途：配合M4螺帽，使LED導光於面板上，使光線均勻、柔和、防水，方便使用。

✓ 通過IP68防水測試

2

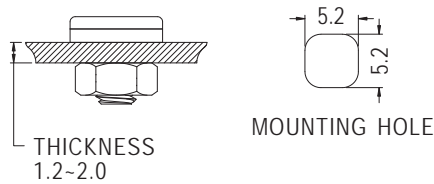

Part No.	Part No.	Package
LEMA-2F	LEMA-2	1000
	TF-807	
	M-4	
子母包：內容物包含右方零件 上述零件亦可單獨選購		

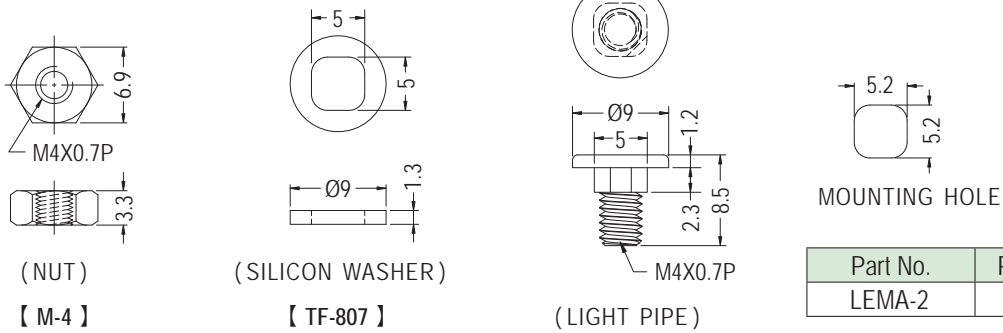

Part No.	Package
LEMA-2	2000

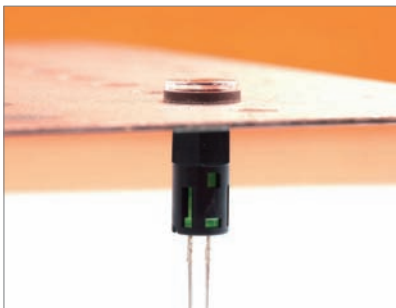

- Material: Nylon 66 (UL)
- Flame Class: 94V-2/94V-0
- Color: Natural/Black
- Unit: mm
- Patented (專利品)

用途：可快速將Ø5 mm LED固定於機器面板上，防水性佳。

✓ 通過IP68防水測試

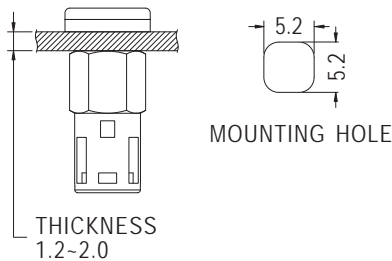

- 適用Ø5 LED帽緣款
- 適用於2 PIN、3 PIN

Part No.	Part No.	Package
LEMA-3F	LEMA-2	1000
	LEMA-3A	
	TF-807	
子母包：內容物包含右方零件 上述零件亦可單獨選購		

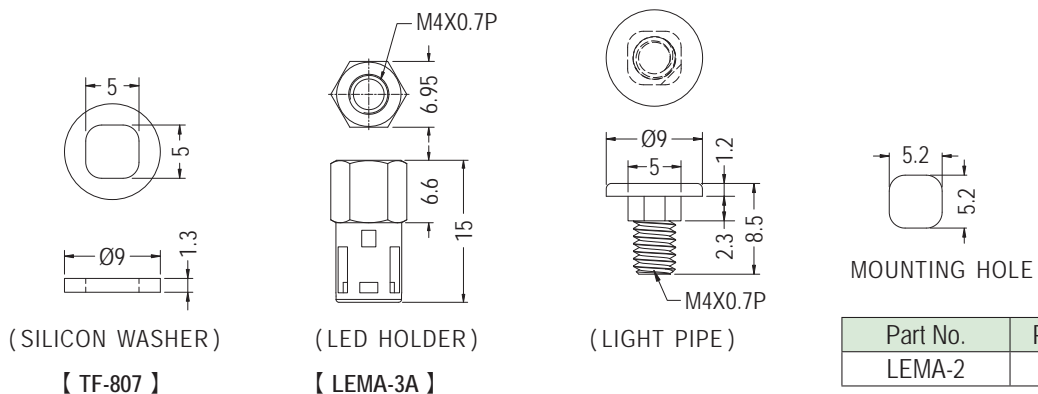

Part No.	Package
LEMA-2	2000

LED導光座 LIGHT GUIDE HOLDER



- Material: Nylon 66 (UL)/PC (UL)
- Flame Class: 94V-2/94V-0
- Color: Transparent/Black
- Unit: mm
- Patented (專利品)

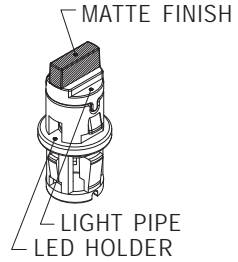
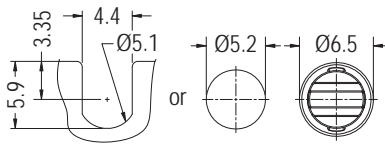

用途：可快速將LED固定於機器面板上，使LED導光於機殼面板上，使光線均勻、柔和。



使用說明
Installation Step

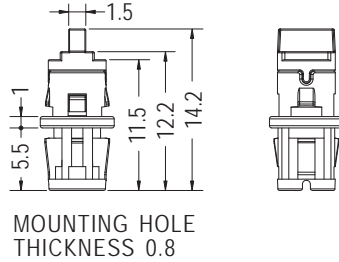

- 適用Ø3 LED帽緣款
- 適用於2 PIN、3 PIN

Part No.	Part No.	Package
LEMA-6F	LED3-52	1000
	LEM-234	
	子母包：內容物包含右方零件 上述零件亦可單獨選購	

LED光纖座 LED OPTICAL FIBER HOLDER

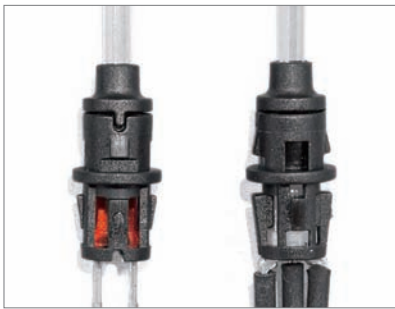

- Material: Nylon 66 (UL)
- Flame Class: 94V-2/94V-0
- Color: Black
- Unit: mm
- Patented (專利品)

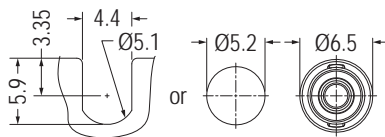

用途：配合光纖將LED光導到機器面板上。

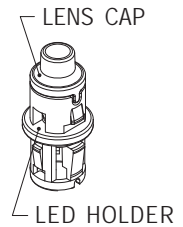

【PMR-12-1F】

- 適用Ø3 LED帽緣款
- 適用於2 PIN、3 PIN



使用說明
Installation Step

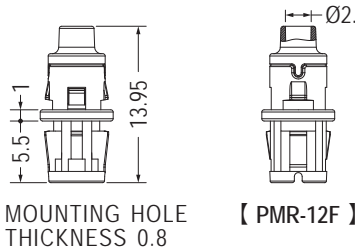

Part No.	Part No.	Package
PMR-12F	LED3-52	1000
	PMR-12	
★PMR-12-1F	LED3-52	1000
	★PMR-12-1	
子母包：內容物包含右方零件 上述零件亦可單獨選購		

- Material: Nylon 66 (UL)
- Flame Class: 94V-2
- Color: Black
- Unit: mm
- Patented (專利品)

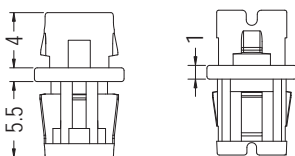
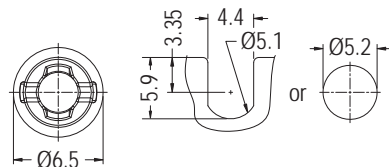

MOUNTING HOLE
THICKNESS 0.8

【LED3-52】

- Material: PC (UL)
- Flame Class: 94V-2
- Color: Transparent
- Unit: mm
- Patented (專利品)

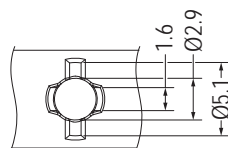
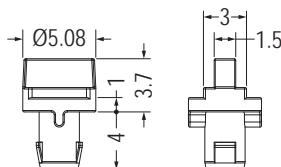

MOUNTING HOLE

【LEM-234】

- Material: Nylon 66 (UL)
- Flame Class: 94V-2
- Color: Black
- Unit: mm
- Patented (專利品)

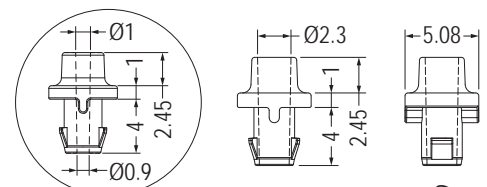

【PMR-12-1】

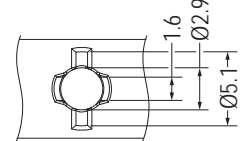

MOUNTING HOLE

【PMR-12】

LED導光蓋 LENS CAP



- Material: PC (UL)
- Flame Class: 94V-2/94V-0
- Color: Transparent
- Unit: mm

用途：將LED導光於機殼面板上，使光度均勻、柔和。搭配LC3-1T、LC3-2T、LC3-3T更緊密穩固。

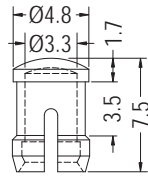

CHASSIS Ø4.4
THICKNESS 1.57-3.2

Part No.	Package
LC3-1	2000

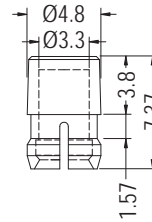

CHASSIS Ø4.4
THICKNESS 1.2

Part No.	Package
LC3-6	2000

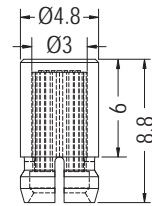

CHASSIS Ø4.4
THICKNESS 0.7

Part No.	Package
LC3-13	2000

LED座套 LED HOLDER COVER



- Material: Nylon 66 (UL)
- Flame Class: 94V-2/94V-0
- Color: Natural/Black
- Unit: mm

用途：LC3-1T可加強LC3-1之固定，或做為墊片使用。

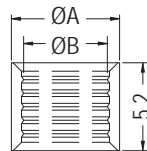

Part No.	A	B	Package
LC3-1T	6.8	5.2	2000
LC3-2T	6.4	4.95	
LC3-3T	6.4	5.0	

LED導光蓋 LENS CAP



- Material: PC (UL)
- Flame Class: 94V-2/94V-0
- Color: Transparent
- Unit: mm

用途：將LED導光於機殼面板上，使光度均勻、柔和。

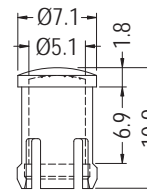

CHASSIS Ø6.4
THICKNESS 0.8-6.35

Part No.	Package
LC5-1	1000

LED座套 LED HOLDER COVER



- Material: Nylon 66 (UL)
- Flame Class: 94V-2/94V-0
- Color: Natural/Black
- Unit: mm

用途：LC5-1T、LC5-2T可加強LC5-1之固定，或作為墊片使用。

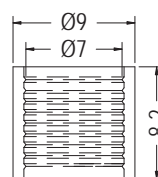

Part No.	Package
LC5-1T	1000

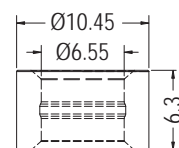

Part No.	Package
LC5-2T	1000

LED導光蓋 LENS CAP

用途：置LED導光於機殼面板上，使光度均勻、柔和。

- Material: PC (UL)
- Flame Class: 94V-2/94V-0
- Color: Transparent
- Unit: mm

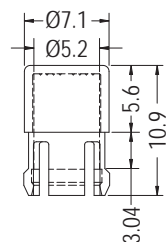

MOUNTING HOLE $\varnothing 6.35$
THICKNESS 3.0

Part No.	Package
LC5-2	1000

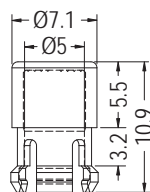

MOUNTING HOLE $\varnothing 6.4$
THICKNESS 3.0

Part No.	Package
LC5-9	1000

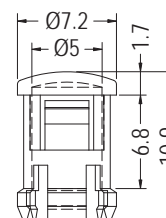

MOUNTING HOLE $\varnothing 6.4$
THICKNESS 0.8

Part No.	Package
LC5-4	1000

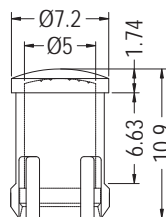

MOUNTING HOLE $\varnothing 6.4$ - $\varnothing 6.45$
THICKNESS 0.8-6.35

Part No.	Package
LC5-5	2000

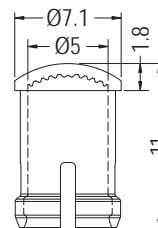

MOUNTING HOLE $\varnothing 6.4$ - $\varnothing 6.45$
THICKNESS 0.8-6.35

Part No.	Package
LC5-6	1000

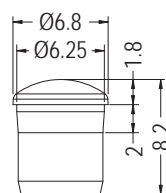

MOUNTING HOLE $\varnothing 6.3$

Part No.	Package
LEM-149	1000

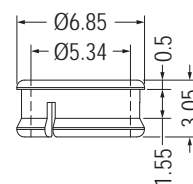

MOUNTING HOLE $\varnothing 6.35$

Part No.	Package
LC5-3	1000

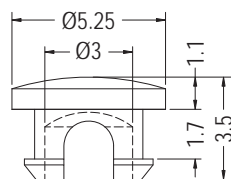

MOUNTING HOLE $\varnothing 3.7$ - $\varnothing 3.8$
THICKNESS 0.8-1.6

Part No.	Package
LC3-8	1000

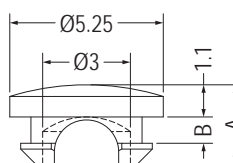

MOUNTING HOLE $\varnothing 4.0$
THICKNESS: T

Part No.	A	B	T	Package
★ LC3-14	2.7	0.9	0.8	1000
★ LC3-14L	2.9	1.1	1.0	

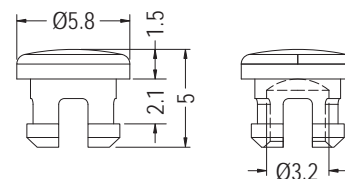

MOUNTING HOLE $\varnothing 4.6$
THICKNESS 2.0

Part No.	Package
LEM-123	1000

LED導光蓋 LENS CAP

用途：置LED導光於機殼面板上，使光度均勻、柔和。



- Material: PC (UL)
- Flame Class: 94V-2/94V-0
- Color: Transparent
- Unit: mm

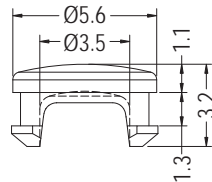

MOUNTING HOLE Ø5.0
THICKNESS 1.3

Part No.	Package
LC5-8	1000

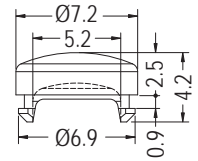

MOUNTING HOLE Ø6.35
THICKNESS 0.8

Part No.	Package
LC5-7	1000

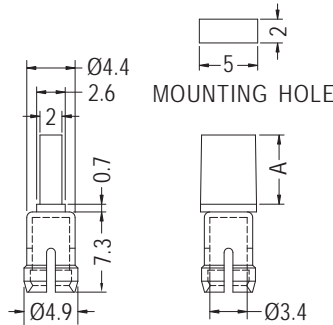

CHASSIS Ø4.4
THICKNESS 1.57-3.2

Part No.	A	Package
LC3-2	6.3	1000
LC3-7	2.5	

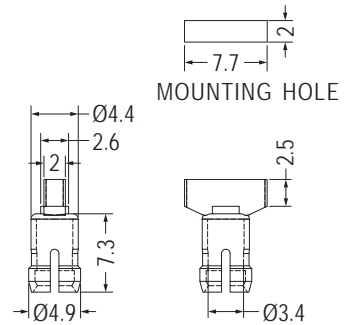

CHASSIS Ø4.4
THICKNESS 1.57-3.2

Part No.	Package
LC3-12	1000

LED燈罩 LED COVER

用途：使用於LED之導光。

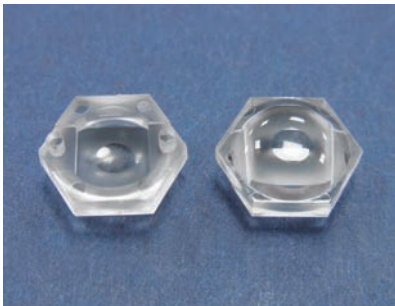

- Material: PC (UL)
- Flame Class: 94V-2/94V-0
- Color: Transparent
- Unit: mm

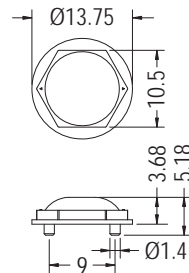

Part No.	Package
LEMA-1	1000

紅外線燈罩 INFRARED RAYS LAMPSHADE

用途：固定於LED TV機殼上，做為紅外線遙控接收器導光面板，過濾無效光源，動作穩定。



- Material: PC (UL)
- Flame Class: 94V-2/94V-0
- Color: Purple
- Unit: mm

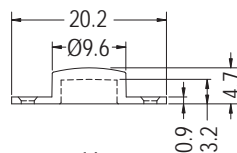

Part No.	Package
IRCV-1	1000

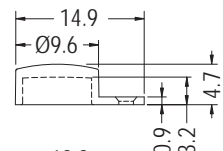
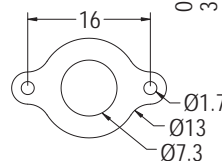

Part No.	Package
IRCV-2	1000

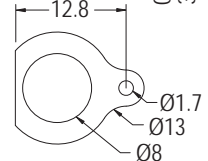

LED 導光柱 LIGHT PIPE

用途：置LED導光於機殼面板上，使光度均勻、柔和。



- Material: PC (UL)
- Flame Class: 94V-2/94V-0
- Color: Transparent
- Unit: mm

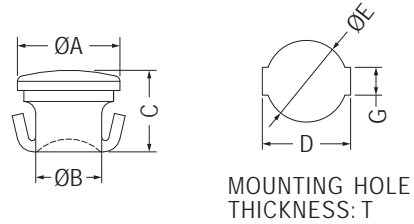

Part No.	A	B	C	D	E	G	T	Package
LEM-7	5.6	3.6	4.5	5.4	5.0	1.7	1.2	1000
LEM-7S	5.6	3.0	4.5	5.4	5.0	1.7	1.2	
LEM-29	4.8	3.2	4.5	5.0	4.3	1.8	1.2	
LEM-161	6.9	4.5	3.8	6.75	6.3	2.1	0.7	



- Material: PC (UL)
- Flame Class: 94V-2/94V-0
- Color: Transparent
- Unit: mm

用途：可將LED導光到機器面板。

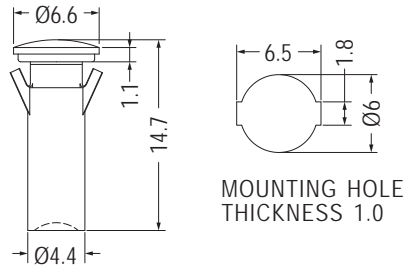

Part No.	Package
LEM-54	1000



- Material: PC (UL)
- Flame Class: 94V-2/94V-0
- Color: Transparent
- Unit: mm

用途：置LED導光於機殼面板上，使光度均勻、柔和。

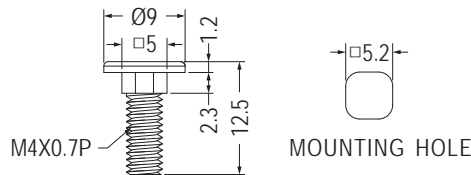

Part No.	Package
LEMA-5	1000

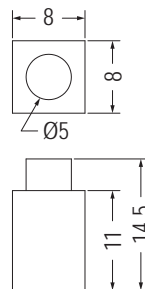

Part No.	Package
LEM-55	2000



- Material: PC (UL)
- Flame Class: 94V-2/94V-0
- Color: Transparent
- Unit: mm

用途：用於LED導光柱。

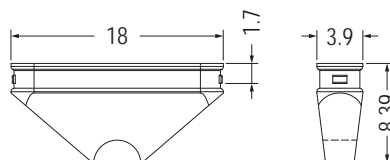

Part No.	Package
LEM-30	1000

LED 導光柱 LIGHT PIPE

用途：置LED導光於機殼面板上，使光度均勻、柔和。



- Material: PC (UL)
- Flame Class: 94V-2/94V-0
- Color: Transparent
- Unit: mm

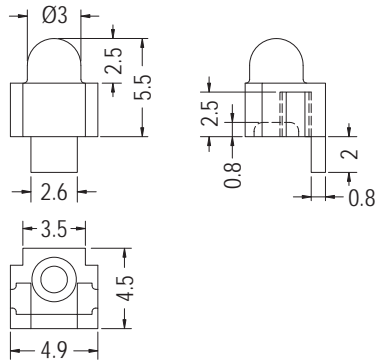

Part No.	Package
LEM-244	2000

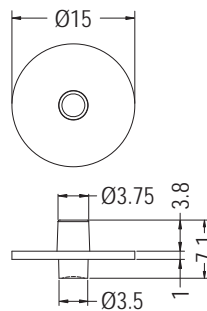
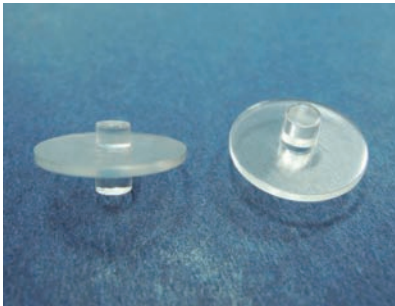

Part No.	Package
LEM-79	1000

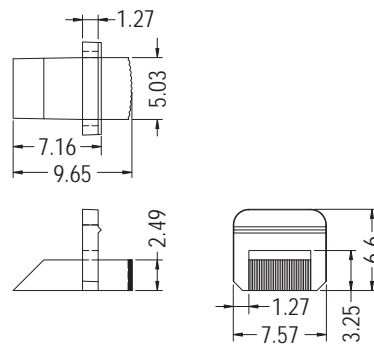
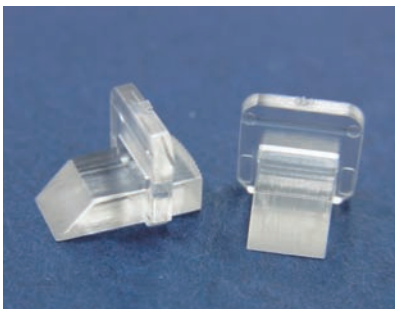

Part No.	Package
LEM-96	1000

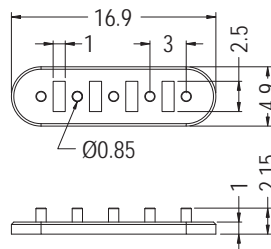

Part No.	Package
LEM-151	500

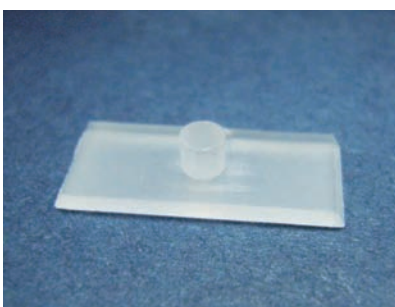

- Material: PMMA
- Color: Transparent
- Unit: mm

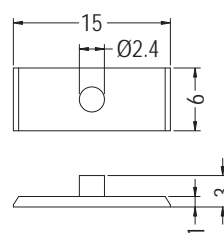

Part No.	Package
LEM-2	1000

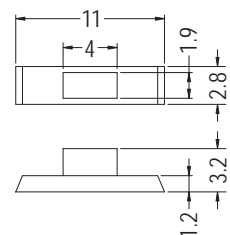

Part No.	Package
LEM-1	1000

LED 導光柱 LIGHT PIPE

用途：置LED導光於機殼面板上，使光度均勻、柔和。

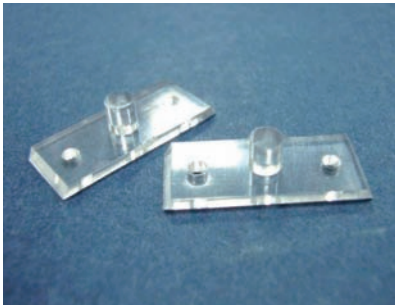

- Material: PC (UL)
- Flame Class: 94V-2/94V-0
- Color: Transparent
- Unit: mm

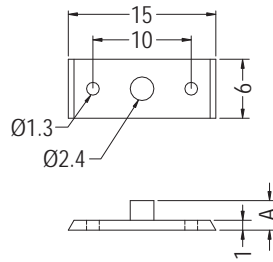

Part No.	A	Package
LEM-9	3.0	1000
LEM-62	3.7	

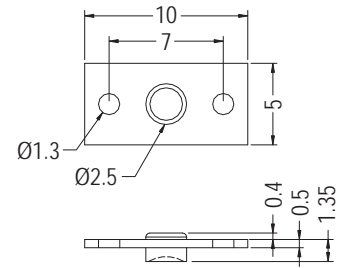

- Material: PMMA
- Color: Transparent

Part No.	Package
LEM-16	1000

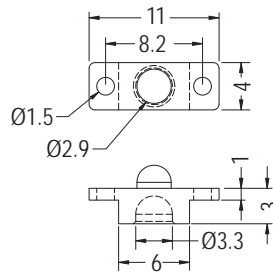

Part No.	Package
LEM-36	1000

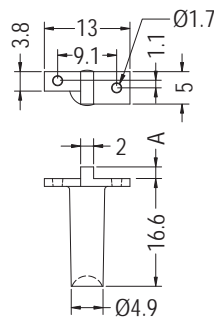

Part No.	A	Package
LEM-3	1.8	1000
LEM-3L	2.2	

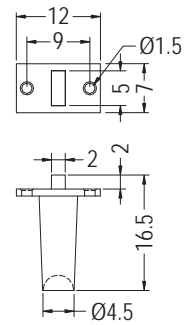

Part No.	Package
LEM-12	1000

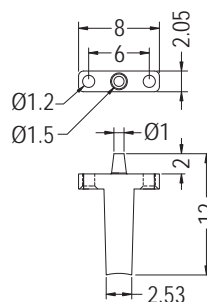
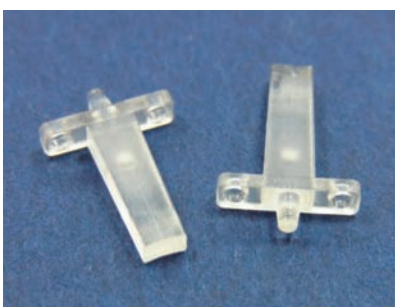

Part No.	Package
LEM-131	500

LED 導光柱 LIGHT PIPE

用途：置LED導光於機殼面板上，使光度均勻、柔和。

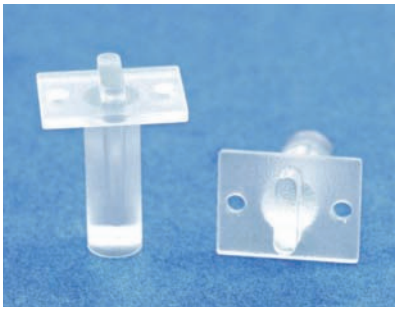

- Material: PC (UL)
- Flame Class: 94V-2/94V-0
- Color: Transparent
- Unit: mm

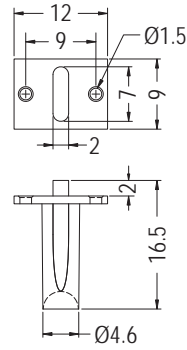

Part No.	Package
LEM-210	1000

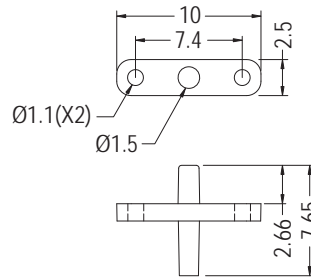

Part No.	Package
LEM-63	1000

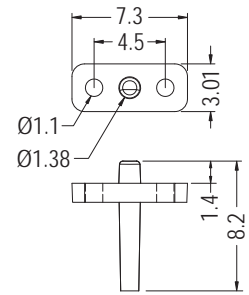

Part No.	Package
LEM-73	1000

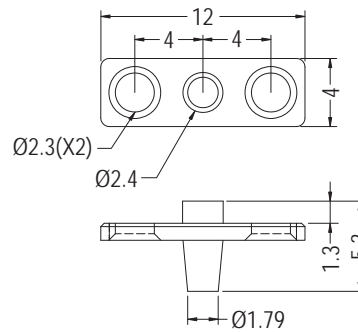
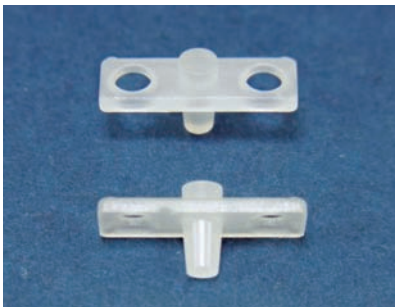

Part No.	Package
LEM-108	1000

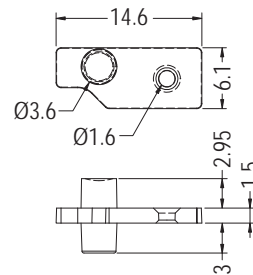
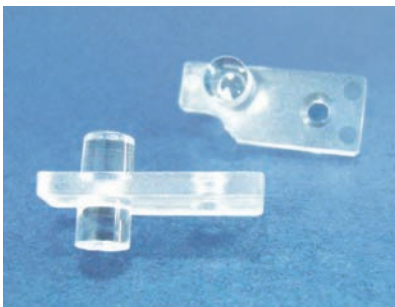

Part No.	Package
LEM-40	500

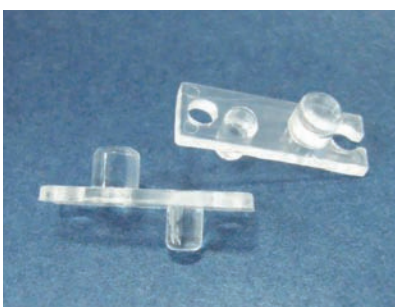

- Material: PMMA
- Color: Transparent
- Unit: mm

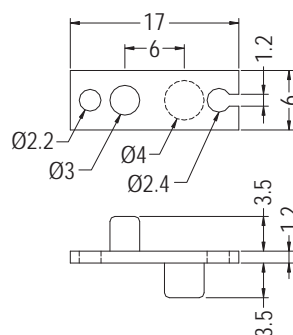

Part No.	Package
LEM-6	1000

LED 導光柱 LIGHT PIPE

用途：置LED導光於機殼面板上，使光度均勻、柔和。

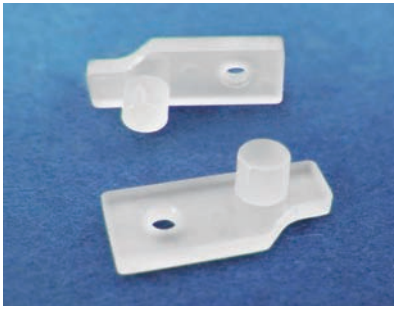

- Material: PMMA
- Color: Transparent
- Unit: mm

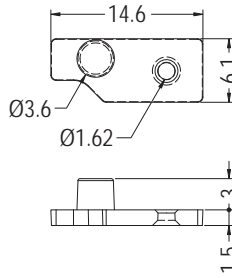

Part No.	Package
LEM-122	500

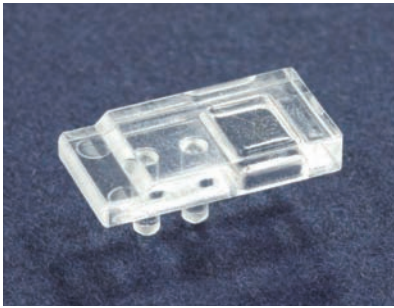

- Material: PC (UL)
- Flame Class: 94V-2/94V-0
- Color: Transparent
- Unit: mm

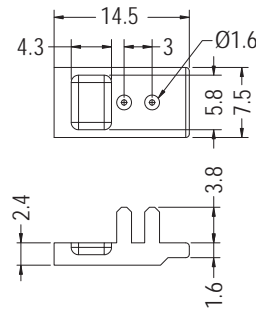

Part No.	Package
LEM-205	1000

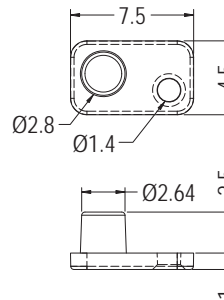

Part No.	Package
LEM-137	2000



- Material: PMMA
- Color: Transparent
- Unit: mm

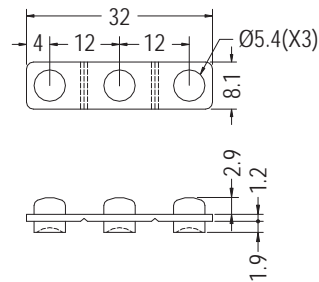

Part No.	Package
LEM-4	500



- Material: PC (UL)
- Flame Class: 94V-2/94V-0
- Color: Transparent
- Unit: mm

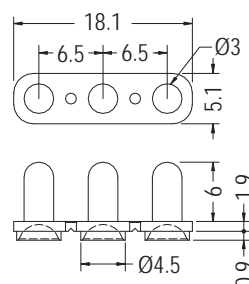

Part No.	Package
LEM-11	1000

LED導光柱 LIGHT PIPE

用途：置LED導光於機殼面板上，使光度均勻、柔和。

2

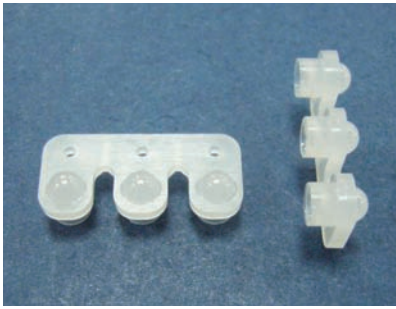

- Material: PC (UL)
- Flame Class: 94V-2/94V-0
- Color: Transparent
- Unit: mm

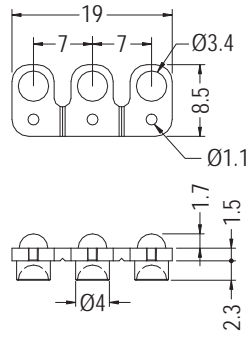

Part No.	Package
LEM-18	1000

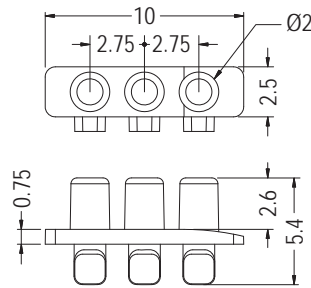

Part No.	Package
LEM-92	1000

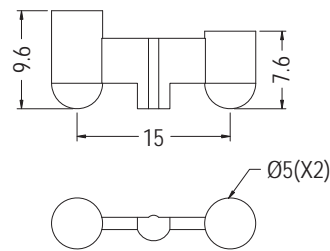

Part No.	Package
LEM-212	1000

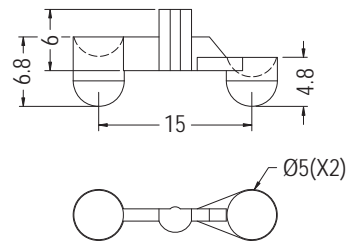

Part No.	Package
LEM-213	1000

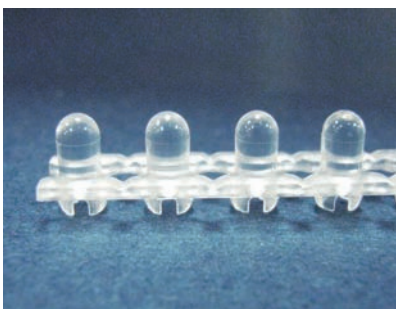

- Material: PC (UL)
- Flame Class: 94V-2/94V-0
- Color: Transparent
- Unit: mm

用途：LED墊高，可固定間隔，長度可自行裁切。

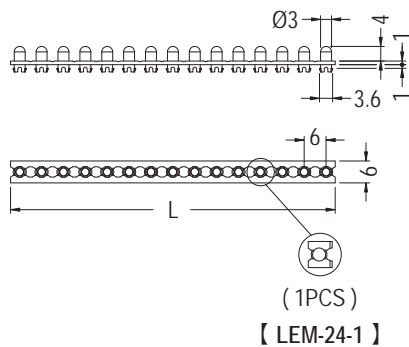

Part No.	L	Package
LEM-24	89.0	500
LEM-24-1	5.5	
LEM-24-2	11.5	
LEM-24-3	17.5	
LEM-24-4	23.5	
LEM-24-11	65.5	
LEM-24-12	71.5	
LEM-24-14	83.5	

LED 導光柱 LIGHT PIPE

用途：用於LED導光柱。



- Material: PC (UL)
- Flame Class: 94V-2/94V-0
- Color: Transparent
- Unit: mm

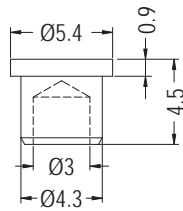

Part No.	Package
LEM-33	1000

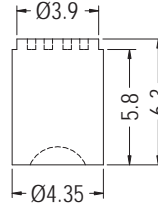

Part No.	Package
LEM-20	1000

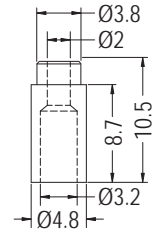

Part No.	Package
LEM-52	1000

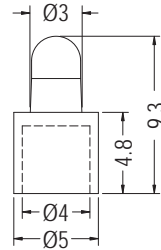

MOUNTING HOLE Ø3.0

Part No.	Package
LEM-103	1000



- Material: PC (UL)
- Flame Class: 94V-2/94V-0
- Color: Transparent
- Unit: mm

用途：置LED導光於機殼面板上，使光度均勻、柔和。

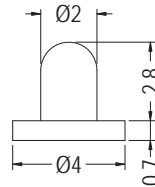

Part No.	Package
LEM-114	1000

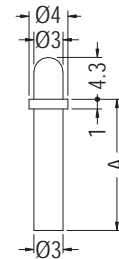

MOUNTING HOLE Ø3.0

Part No.	A	Package
LEM-5	13.5	1000
LEM-5-57	57.0	500
LEM-93	8.7	1000

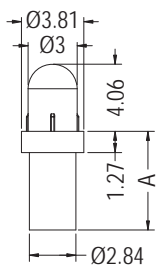

MOUNTING HOLE Ø3.0

Part No.	A	Package
EMP1-3.2	3.2	2000
EMP1-6	6.0	
EMP1-6.4	6.4	
EMP1-8.9	8.9	
EMP1-9.5	9.5	1000
EMP1-11.7	11.68	
EMP1-12.7	12.7	
EMP1-15.9	15.9	
EMP1-19	19.0	
EMP1-21	21.0	

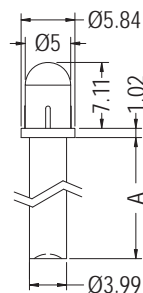

MOUNTING HOLE Ø5.05

Part No.	A	Package
EMP5-3.2	3.2	1000
EMP5-6.4	6.4	2000
EMP5-8.9	8.9	1000
EMP5-9.5	9.5	2000
EMP5-12.7	12.7	1000
EMP5-15.9	15.9	
EMP5-19	19.0	
EMP5-25.4	25.4	
EMP5-29.3	29.3	
EMP5-31.8	31.8	
EMP5-38.1	38.1	

LED 導光柱 LIGHT PIPE

用途：置LED導光於機殼面板上，使光度均勻、柔和。

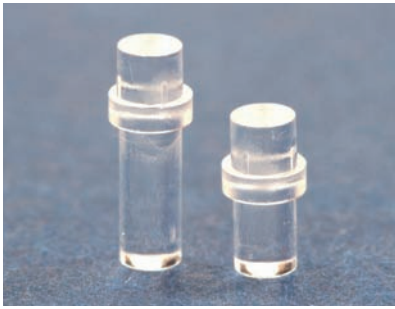

- Material: PC (UL)
- Flame Class: 94V-2/94V-0
- Color: Transparent
- Unit: mm

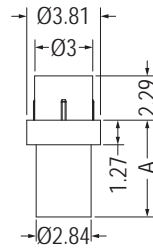

MOUNTING HOLE Ø3.05

Part No.	A	Package
EMP1-2.5-F	2.5	1000
EMP1-3.2-F	3.2	2000
EMP1-4.8-F	4.8	

Part No.	A	Package
EMP1-5-F	5.0	2000
EMP1-6.4-F	6.4	
EMP1-7-F	7.0	
EMP1-8-F	8.0	
EMP1-8.9-F	8.9	
EMP1-9.5-F	9.5	1000
EMP1-10-F	10.0	
EMP1-12.7-F	12.7	
EMP1-15.9-F	15.9	
EMP1-19-F	19.0	
EMP1-21-F	21.1	

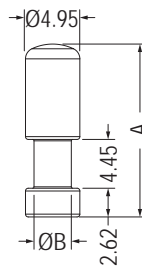

Part No.	A	B	Package
LEM-13	14.1	3.53	1000
LEM-23	15.75	3.4	

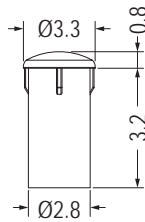

MOUNTING HOLE Ø3.0

Part No.	Package
LEM-144	2000

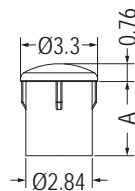

MOUNTING HOLE: ØG

Part No.	A	G	Package
EMP2-2.5	2.5	3.0	2000
EMP2-3.2	3.2	3.0	
EMP2-4	4.0	3.05	
EMP2-4.8	4.8	3.0	
EMP2-5	5.0	3.0	
EMP2-5.5	5.5	3.0	
EMP2-6	6.0	3.0	
EMP2-6.4	6.4	3.0	
EMP2-7	7.0	3.0	
EMP2-8	8.0	3.05	

Part No.	A	G	Package
EMP2-8.9	8.9	3.0	2000
EMP2-9.5	9.5	3.0	
EMP2-10	10.0	3.0	
EMP2-12.7	12.7	3.0	
EMP2-15.9	15.9	3.0	
EMP2-19	19.0	3.0	
★EMP2-22.2	22.2	3.0	
EMP2-24	24.0	3.0	1000
EMP2-25.4	25.4	3.05	
EMP2-30.5	30.5	3.0	

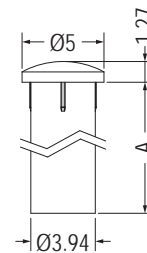

MOUNTING HOLE Ø4.0



Part No.	A	Package
EMP5-2-3.2	3.2	1000
EMP5-2-6.4	6.4	2000
EMP5-2-8.9	8.9	1000
EMP5-2-9.5	9.5	
EMP5-2-12.7	12.7	
EMP5-2-15.9	15.9	
EMP5-2-19	19.0	
EMP5-2-22	22.0	
EMP5-2-25.4	25.4	
EMP5-2-31.8	31.8	
EMP5-2-38.1	38.1	

LED 導光柱 LIGHT PIPE

用途：置LED導光於機殼面板上，使光度均勻、柔和。

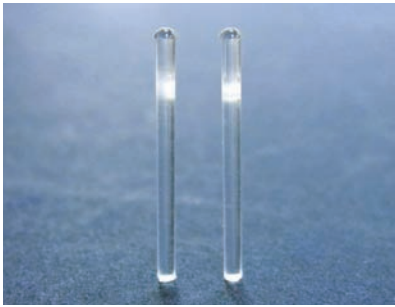

- Material: PC (UL)
- Flame Class: 94V-2/94V-0
- Color: Transparent
- Unit: mm

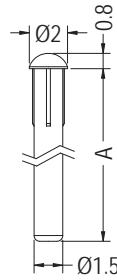

MOUNTING HOLE $\varnothing 1.55$

Part No.	A	Package
LEM-132	20.0	2000
LEM-141	21.8	
LEM-193	29.2	
LEM-199	10.16	

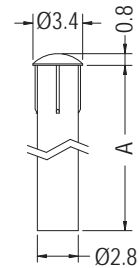

MOUNTING HOLE $\varnothing 3.0$

Part No.	A	Package
LEM-87	18.0	2000
LEM-235-7.2	7.2	1000
LEM-235	12.2	

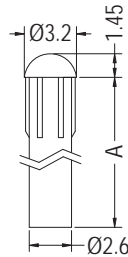

MOUNTING HOLE $\varnothing 3.0$

Part No.	A	Package
LEM-67	6.0	2000
LEM-67-13	13.0	
LEM-67-17.5	17.5	
LEM-67-20.5	20.5	1000
LEM-67-27.5	27.5	

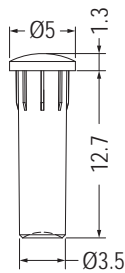

MOUNTING HOLE $\varnothing 3.8$

Part No.	Package
LEM-156	1000



MOUNTING HOLE $\varnothing 4.4$

Part No.	Package
LEM-262M	1000



MOUNTING HOLE: $\varnothing G$

Part No.	A	G	Package
LEM-53	21.55	4.3	2000
LEM-53-7	7.0	4.2	
LEM-53-8.5	8.5	4.2	
LEM-53-16.5	16.5	4.2	
LEM-53-19	19.0	4.2	
LEM-53-24	24.0	4.2	1000
LEM-191	43.5	4.3	
LEM-191-36	36.0	4.3	
LEM-191-37.5	37.5	4.3	
LEM-198	30.0	4.3	
LEM-202	54.0	4.3	

LED 導光柱 LIGHT PIPE

用途：置LED導光於機殼面板上，使光度均勻、柔和。

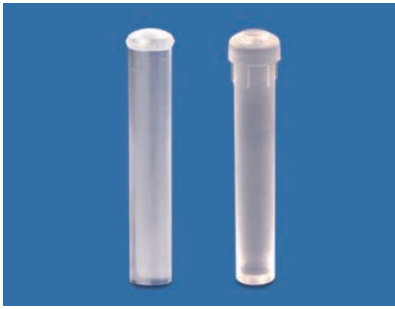

- Material: PC (UL)
- Flame Class: 94V-2/94V-0
- Color: Transparent
- Unit: mm

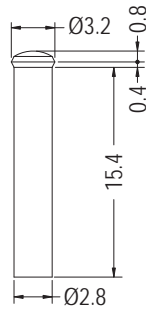

Part No.	Package
LEM-248	1000

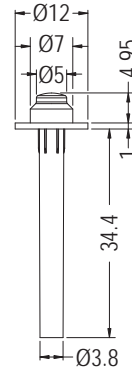

MOUNTING HOLE Ø4.3

Part No.	Package
LEM-266	500

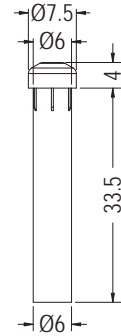

MOUNTING HOLE Ø6.5

Part No.	Package
LEM-233	500

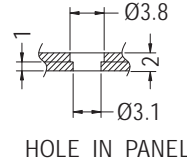
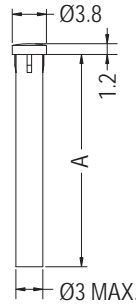
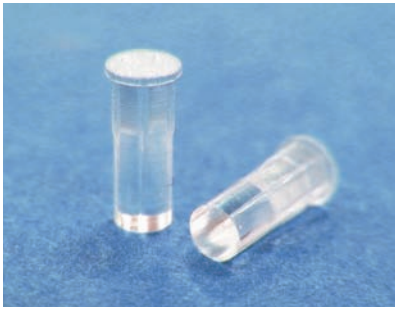

HOLE IN PANEL

Part No.	A	Package
LEM-90	23.6	2000
LEM-91	8.0	
LEM-192	25.85	

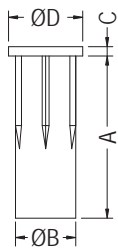

MOUNTING HOLE: ØG

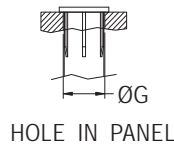

HOLE IN PANEL

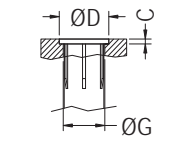

HOLE IN PANEL

Part No.	A	B	C	D	G	Package
LEM-97	21.0	4.0	0.5	5.0	4.2	1000
LEM-97S	8.5	4.0	0.5	5.0	4.2	
LEM-98	28.0	4.0	0.5	5.0	4.2	
LEM-135	7.0	2.6	0.4	3.2	3.0	2000
LEM-135-4.8	4.8	2.6	0.4	3.2	3.0	
LEM-167	10.05	2.5	0.45	3.2	2.8	
LEM-167-11	11.0	2.5	0.45	3.2	2.8	
LEM-167-15	15.0	2.5	0.45	3.2	2.8	
LEM-189	25.0	2.6	0.4	3.2	3.0	

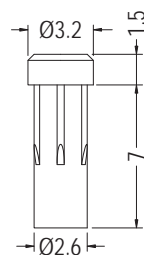
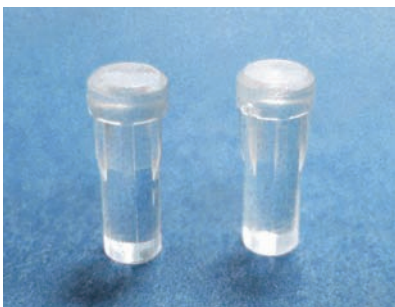

PLASTIC MOUNTING HOLE Ø2.8
METAL MOUNTING HOLE Ø3.0

Part No.	Package
LEM-88	2000

LED 導光柱 LIGHT PIPE

用途：置LED導光於機殼面板上，使光度均勻、柔和。



- Material: PC (UL)
- Flame Class: 94V-2/94V-0
- Color: Transparent
- Unit: mm

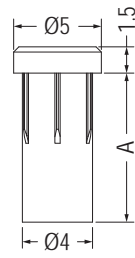

MOUNTING HOLE Ø4.3

Part No.	A	Package
LEM-196	4.0	1000
LEM-197	8.5	



- Material: PC
- Color: Transparent
- Unit: mm

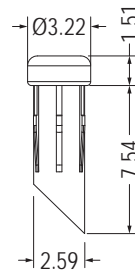

MOUNTING HOLE Ø2.7-Ø2.8

Part No.	Package
LEM-208	2000



- Material: PC (UL)
- Flame Class: 94V-2/94V-0
- Color: Transparent
- Unit: mm

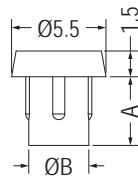

MOUNTING HOLE Ø3.5

Part No.	A	B	Package
LEM-150	4.0	3.5	2000
LEM-150-3	3.0	3.5	
LEM-150-3.5	3.5	3.5	
LEM-240	4.0	3.45	

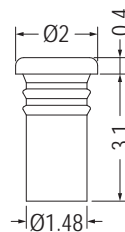

MOUNTING HOLE Ø1.5

Part No.	Package
LEM-133	2000



- Material: PMMA
- Color: Transparent
- Unit: mm

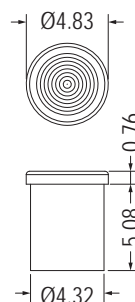

MOUNTING HOLE Ø4.4

Part No.	Package
LEM-223	1000

LED 導光柱 LIGHT PIPE

用途：置LED導光於機殼面板上，使光度均勻、柔和。

- Material: PC (UL)
- Flame Class: 94V-2/94V-0
- Color: Transparent
- Unit: mm

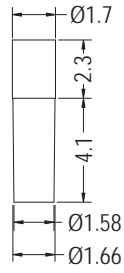
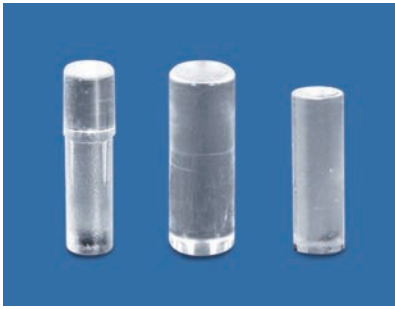

MOUNTING HOLE Ø1.6

Part No.	Package
LEM-185	2000



Part No.	Package
LEM-200	2000

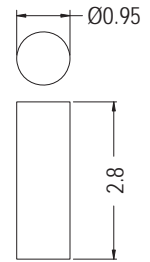

Part No.	Package
LEM-261	2000

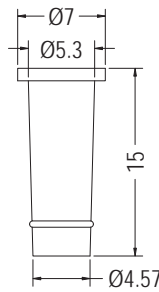

Part No.	Package
LEM-253	1000

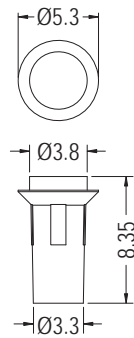

MOUNTING HOLE Ø3.5

Part No.	Package
LEM-221	1000



Part No.	A	B	Package
LEM-70	24.0	29.0	1000
LEM-95	29.0	34.0	
LEM-107	20.5	25.5	

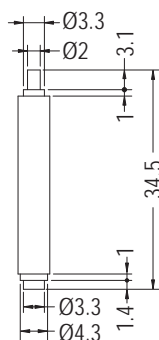

Part No.	Package
LEM-110	1000

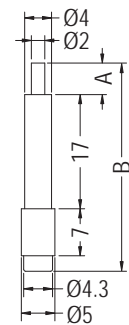

Part No.	A	B	Package
LEM-99	4.7	31.0	1000
LEM-115	1.7	28.0	

LED 導光柱 LIGHT PIPE

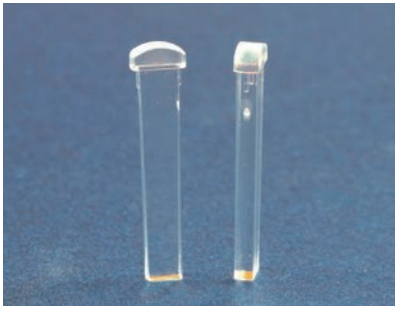

- Material: PC (UL)
- Flame Class: 94V-2/94V-0
- Color: Transparent
- Unit: mm

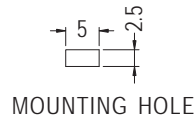
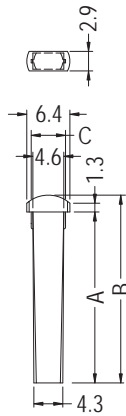

用途：置SMT LED導光於機殼面板上，使光度均勻、柔和。

Part No.	A	B	C	Package
LEM-188	25.4	27.9	5.1	1000
LEM-188-17	17.0	19.5	5.15	

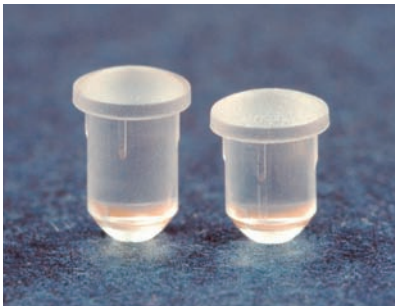

- Material: PC (UL)
- Flame Class: 94V-2/94V-0
- Color: Transparent
- Unit: mm

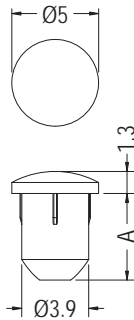

MOUNTING HOLE Ø3.96

用途：置LED導光於機殼面板上，使光度均勻、柔和。

Part No.	A	Package
LEM4W-3.2	3.2	2000
LEM4W-4	4.0	
LEM4W-5	5.0	
LEM4W-6	6.0	
LEM4W-8	8.0	
LEM4W-10	10.0	
LEM4W-12.7	12.7	

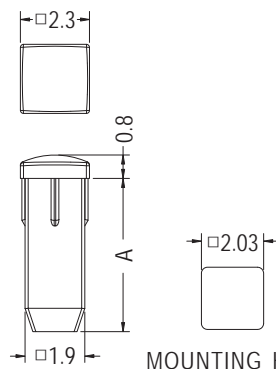

MOUNTING HOLE

Part No.	A	Package
LEMC1-3	3.0	2000
LEMC1-4.8	4.8	
LEMC1-5	5.0	
LEMC1-9	9.0	
LEMC1-12.7	12.7	

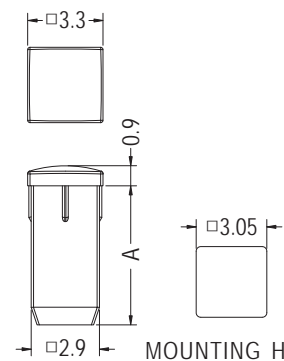

MOUNTING HOLE

Part No.	A	Package
LEMC2-2.5	2.5	2000
LEMC2-3	3.0	
LEMC2-5	5.0	
LEMC2-6	6.0	
LEMC2-7	7.0	

LED 導光柱 LIGHT PIPE

用途：置LED導光於機殼面板上，使光度均勻、柔和。



- Material: PC (UL)
- Flame Class: 94V-2/94V-0
- Color: Transparent
- Unit: mm

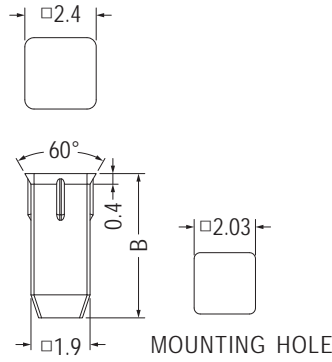

Part No.	B	Package
LEMD1-2.5	2.5	2000
LEMD1-3	3.0	
★LEMD1-3.2	3.2	
LEMD1-4.8	4.8	
LEMD1-10	10.0	

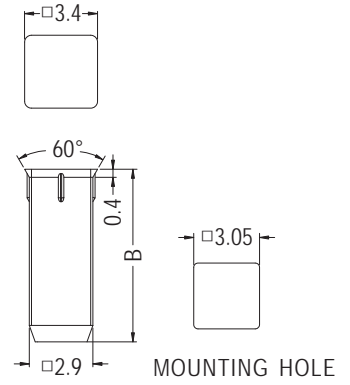

Part No.	B	Package
LEMD2-3	3.0	2000
LEMD2-8	8.0	

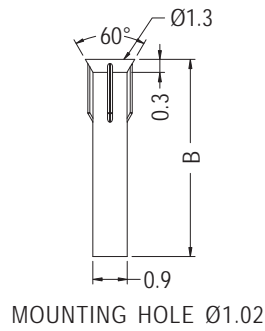
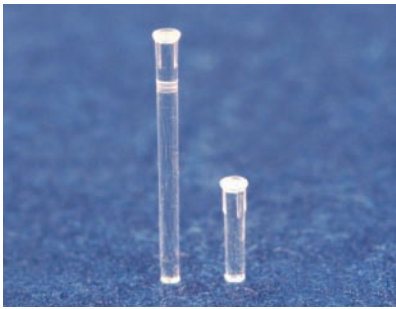

Part No.	B	Package
LEMB1-2.5-F	2.5	2000
LEMB1-3-F	3.0	
LEMB1-4-F	4.0	
LEMB1-4.8-F	4.8	
LEMB1-5-F	5.0	
LEMB1-6-F	6.0	
★LEMB1-6.4-F	6.4	
LEMB1-10-F	10.0	
LEMB1-12.7-F	12.7	
LEMB1-13.7-F	13.7	

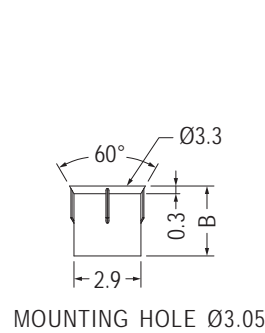
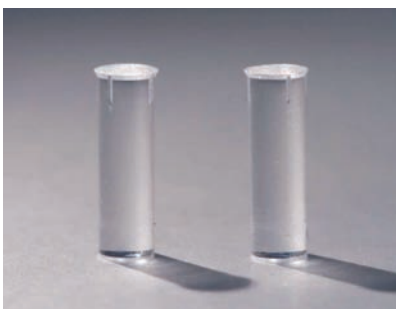

Part No.	B	Package
LEMB3-2.5-F	2.5	2000
LEMB3-3-F	3.0	
LEMB3-3.2-F	3.2	
LEMB3-5-F	5.0	
LEMB3-6-F	6.0	
★LEMB3-7-F	7.0	
LEMB3-8-F	8.0	
LEMB3-9.5-F	9.5	
LEMB3-10-F	10.0	
LEMB3-12.7-F	12.7	

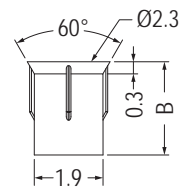

MOUNTING HOLE Ø1.98

Part No.	B	Package	
LEMB2-2-F	2.0	2000	
LEMB2-2.5-F	2.5		
LEMB2-3-F	3.0		
LEMB2-3.2-F	3.2		
LEMB2-4-F	4.0		
LEMB2-4.8-F	4.8		
LEMB2-5-F	5.0		
LEMB2-6.4-F	6.4		
LEMB2-7-F	7.0		
LEMB2-8-F	8.0		
LEMB2-9-F	9.0		
LEMB2-10-F	10.0		
LEMB2-20-F	20.0		1000

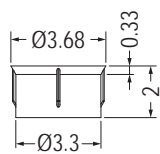

MOUNTING HOLE Ø3.5

Part No.	Package
LEMB3.5-2-F	2000

LED 導光柱 LIGHT PIPE

用途：置LED導光於機殼面板上，使光度均勻、柔和。

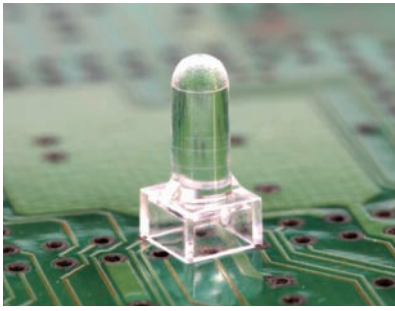

- Material: PC (UL)
- Flame Class: 94V-2/94V-0
- Color: Transparent
- Unit: mm

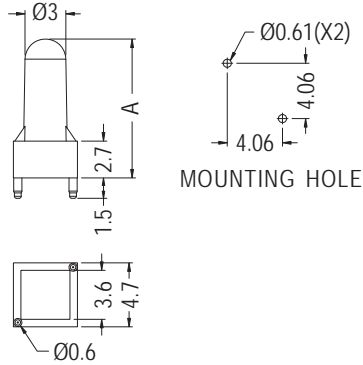

Part No.	A	Package
PL1-5.1	5.1	2000
PL1-7.6	7.6	1000
PL1-8.9	8.9	
PL1-10.2	10.2	
PL1-11.4	11.4	
PL1-12.7	12.7	
PL1-13.9	13.9	
PL1-16.5	16.5	
PL1-21.5	21.5	

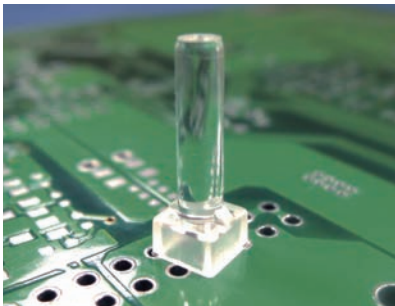

- Material: PC (UL)
- Flame Class: 94V-2/94V-0
- Color: Transparent
- Unit: mm

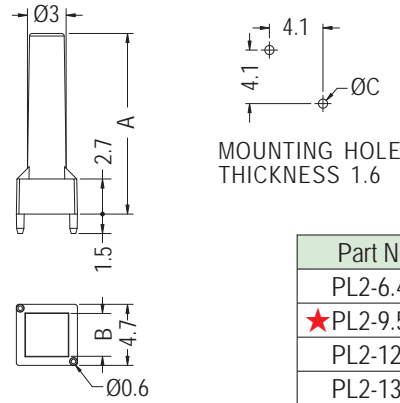

用途：置SMT LED導光於機殼面板上，使光度均勻、柔和。

Part No.	A	B	C	Package
PL2-6.4-F	6.4	3.6	0.61	2000
★PL2-9.5-F	9.5	3.3	0.65	
PL2-12.7-F	12.7	3.3	0.65	1000
PL2-13.9-F	13.9	3.3	0.65	



- Material: PC (UL)
- Flame Class: 94V-2/94V-0
- Color: Transparent
- Unit: mm

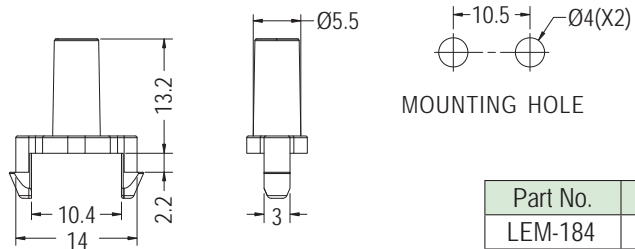

用途：置LED導光於機殼面板上，使光度均勻、柔和。

Part No.	Package
LEM-184	1000



- Material: PC (UL)
- Flame Class: 94V-2/94V-0
- Color: Transparent
- Unit: mm

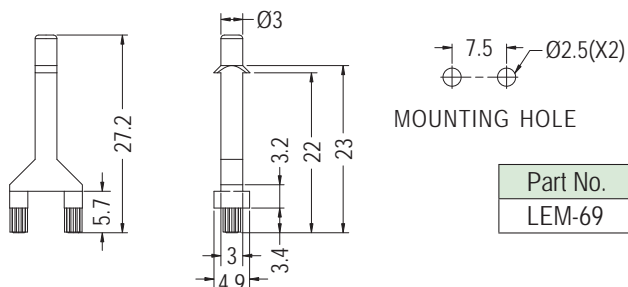

用途：置SMT LED導光於機殼面板上，使光度均勻、柔和。

Part No.	Package
LEM-69	500

LED 導光柱 LIGHT PIPE

2



- Material: PC (UL)
- Flame Class: 94V-2/94V-0
- Color: Transparent
- Unit: mm

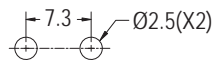
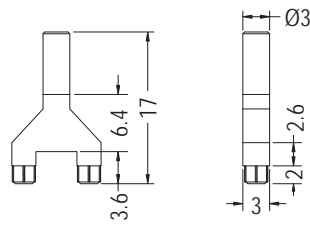

MOUNTING HOLE

Part No.	Package
LEM-180	2000

用途：置SMT LED導光於機殼面板上，使光度均勻、柔和。

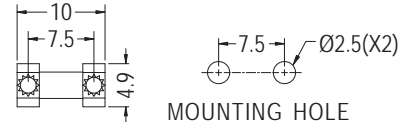
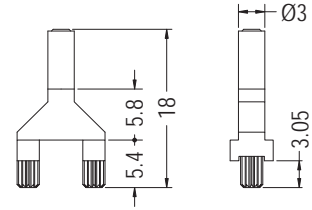

MOUNTING HOLE

Part No.	Package
LEM-270	1000

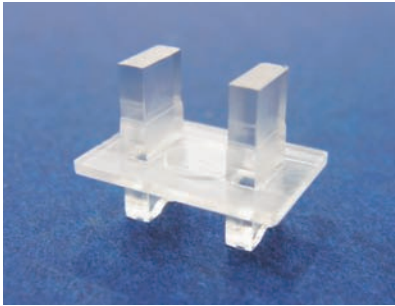

- Material: PC (UL)
- Flame Class: 94V-2/94V-0
- Color: Transparent
- Unit: mm

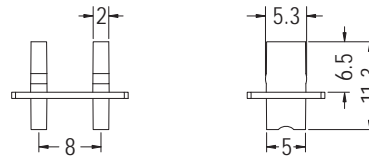
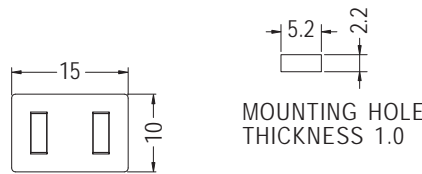

Part No.	Package
LEM-106	500

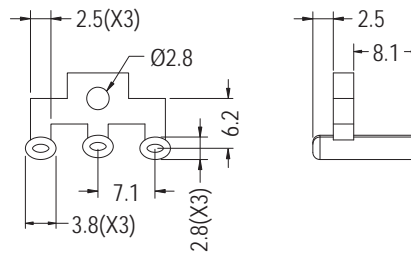
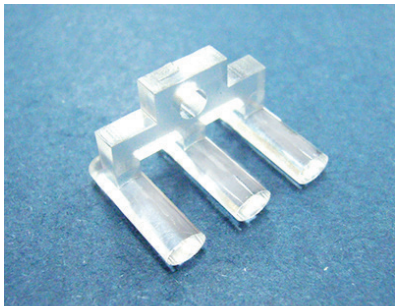

Part No.	Package
LEM-28	500

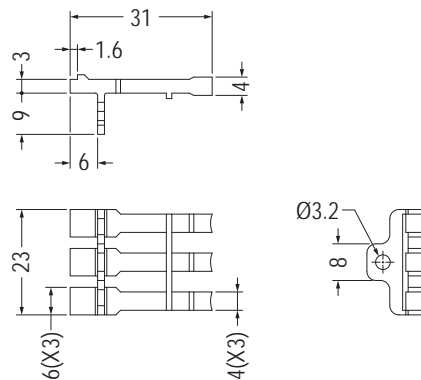

Part No.	Package
LEM-267	1000

LED 導光柱 LIGHT PIPE

用途：置LED導光於機殼面板上，使光度均勻、柔和。

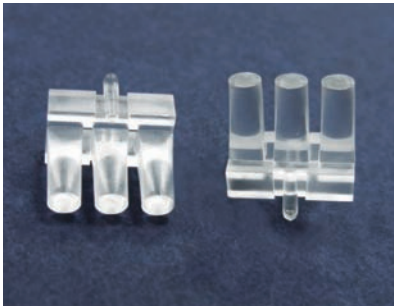

- Material: PC (UL)
- Flame Class: 94V-2/94V-0
- Color: Transparent
- Unit: mm

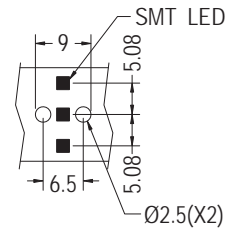
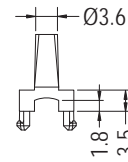
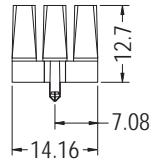
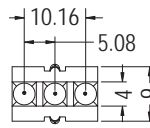

MOUNTING HOLE
P.C.B THICKNESS 1.6

Part No.	Package
LEM-113	500



- Material: PC (UL)
- Flame Class: 94V-2/94V-0
- Color: Transparent
- Unit: mm

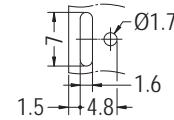
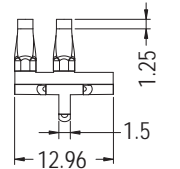
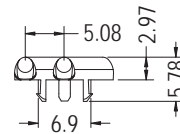

MOUNTING HOLE
P.C.B THICKNESS 1.6

Part No.	Package
LEM-61	2000

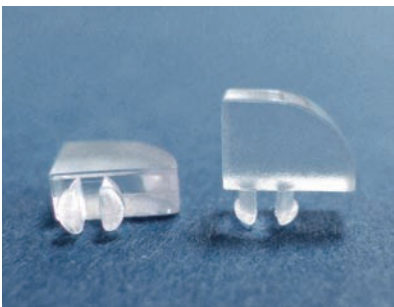

- Material: PC (UL)
- Flame Class: 94V-2/94V-0
- Color: Transparent
- Unit: mm

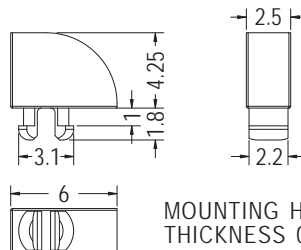

MOUNTING HOLE Ø2.6
THICKNESS 0.9

Part No.	Package
LEM-145	2000

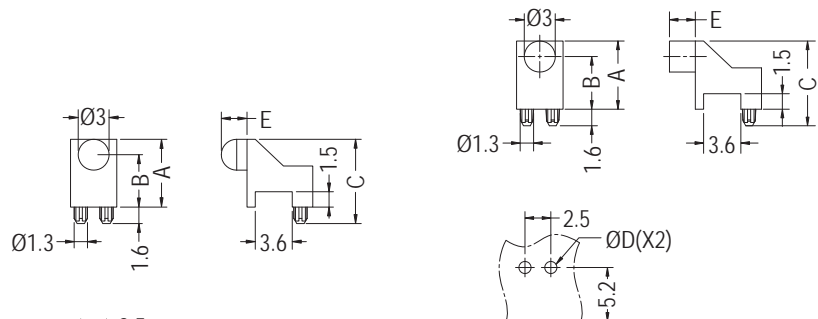

MOUNTING HOLE

【 LEM-136-F, LEM-225-F, LEM-260-F 】

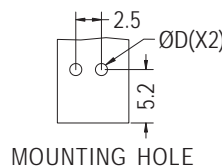

MOUNTING HOLE

Part No.	A	B	C	D	E	Package
LEM-136	6.6	5.1	8.2	1.2	2.5	2000
LEM-136-F	6.6	5.1	8.2	1.2	2.5	2000
LEM-225	5.3	3.8	6.9	1.17	2.5	1000
LEM-225-F	5.3	3.8	6.9	1.17	2.5	1000
LEM-260-F	5.3	3.8	6.9	1.17	3.8	2000

LED導光柱 LIGHT PIPE

用途：置LED導光於機殼面板上，使光度均勻、柔和。



- Material: PC (UL)
- Flame Class: 94V-2/94V-0
- Color: Transparent
- Unit: mm

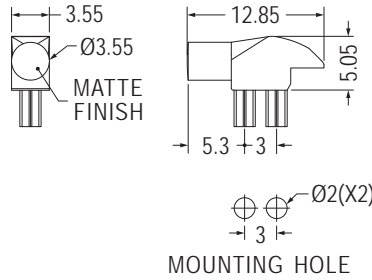

Part No.	Package
LEM-195	1000

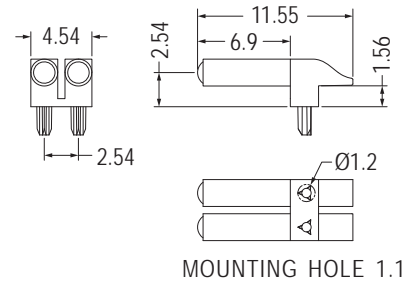

Part No.	Package
LEM-269	2000

2

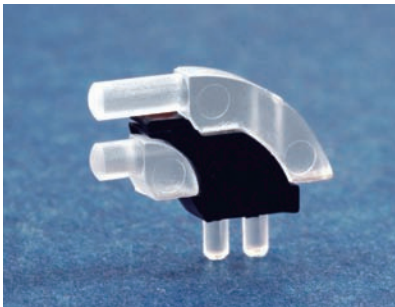

- Material: PC (UL)
- Flame Class: 94V-2/94V-0
- Color: Transparent
- Unit: mm

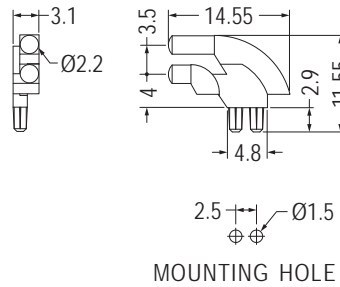

Part No.	Package
LEM-207	1000

用途：置LED導光於機殼面板上，使光度均勻、柔和。LEM-207B遮蔽導光柱，可免鄰近LED光線干擾，配合LEM-207使用。

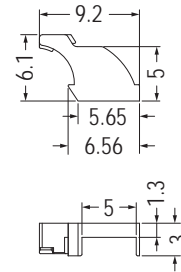

- Material: Nylon 66 (UL)
- Color: Natural/Black

Part No.	Package
LEM-207B	1000



- Material: PC (UL)
- Flame Class: 94V-2/94V-0
- Color: Transparent
- Unit: mm

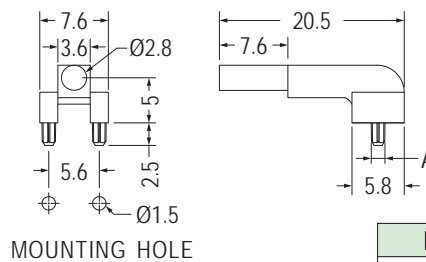

Part No.	A	Package
LPE1-5-20.5	1.7	1000
★LPE1-5-20.5S	1.52	

用途：置SMT LED導光於機殼面板上，使光度均勻、柔和。

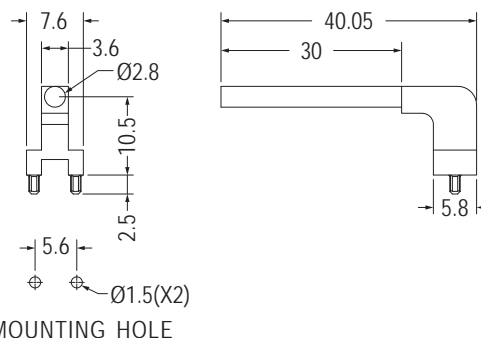
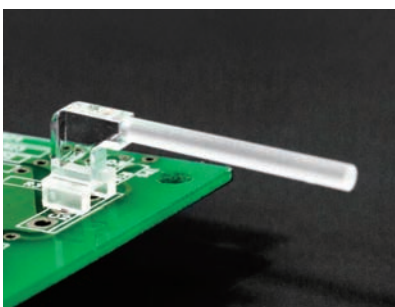

Part No.	Package
LPE1-10.5-40	1000

LED 導光柱 LIGHT PIPE

用途：置SMT LED導光於機殼面板上，使光度均勻、柔和。



- Material: PC (UL)
- Flame Class: 94V-2/94V-0
- Color: Transparent
- Unit: mm

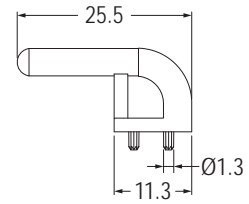
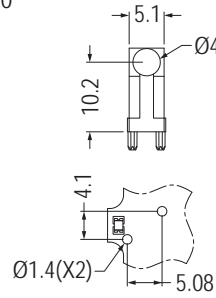

MOUNTING HOLE THICKNESS 1.6

Part No.	Package
LPE1-10.2-25.5	1000

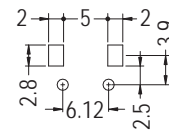
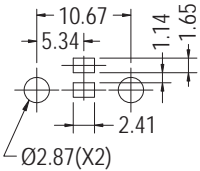
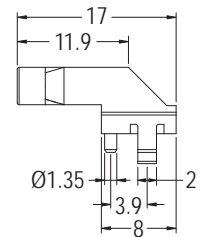
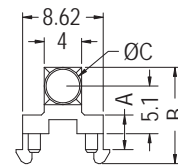
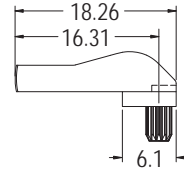
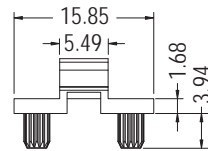
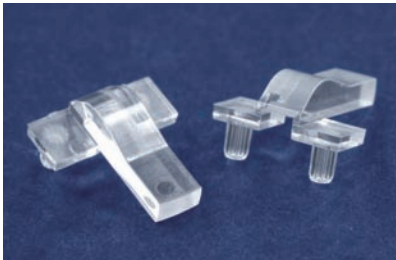

MOUNTING HOLE

MOUNTING HOLE

Part No.	Package
SLP-3	1000

Part No.	A	B	C	Package
LPF1-517	3.7	10.3	4.0	2000
LPF1-518	4.1	10.7	2.6	

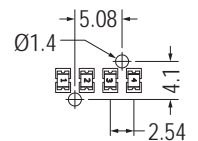
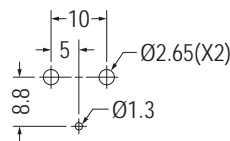
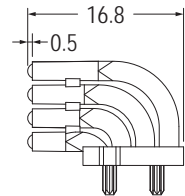
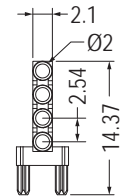
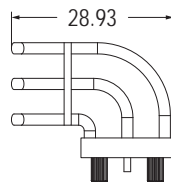
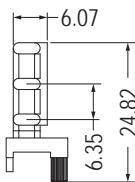
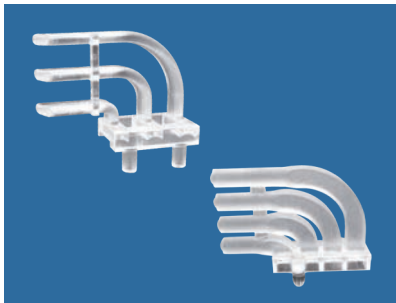
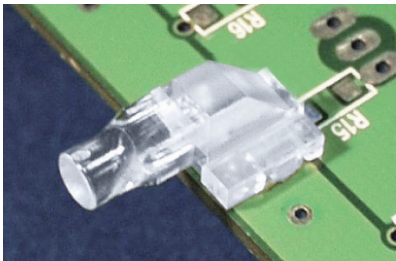

MOUNTING HOLE

HOLE FOR P.C.B THICKNESS 1.6

Part No.	Package
LPE3-7.8	500

Part No.	Package
LPE4-3.6	500

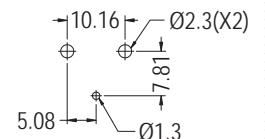
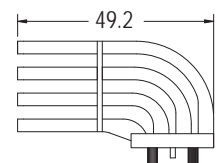
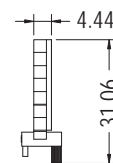
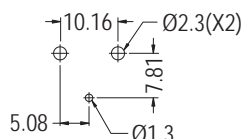
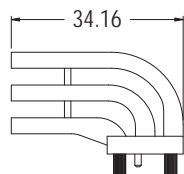
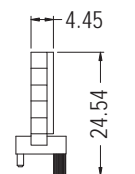
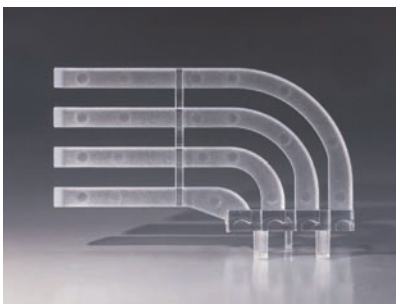

MOUNTING HOLE

MOUNTING HOLE

Part No.	Package
LPEB3-1	500

Part No.	Package
LPEB4-1	500

LED導光柱 LIGHT PIPE

用途：置SMT LED導光於機殼面板上，使光度均勻、柔和。

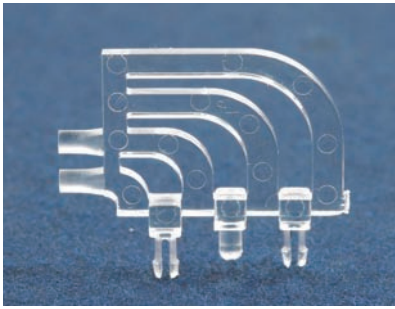

- Material: PC (UL)
- Flame Class: 94V-2/94V-0
- Color: Transparent
- Unit: mm

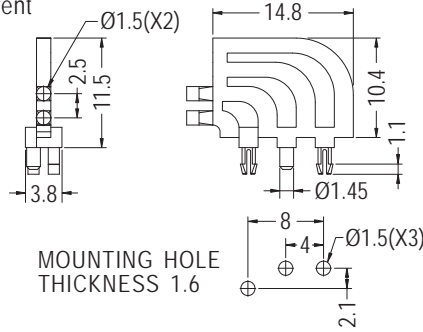

Part No.	Package
LPED2-1	1000

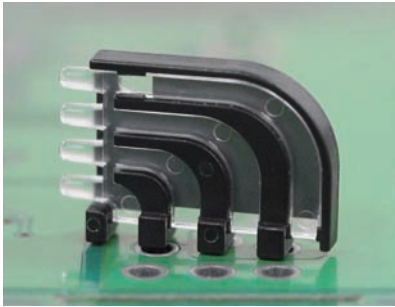

- Material: PC (UL)
- Holder Material: Nylon 66 (UL)
- Flame Class: 94V-2/94V-0
- Color: Transparent
- Holder Color: Black
- Unit: mm

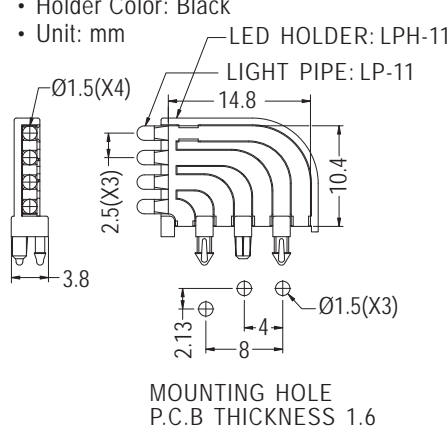

Part No.	Package
LP-11F	1000

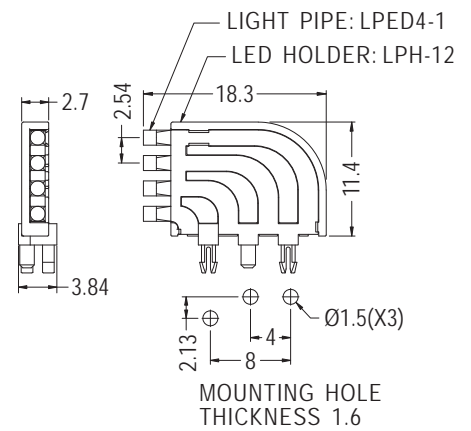

Part No.	Package
LPED4-1F	1000

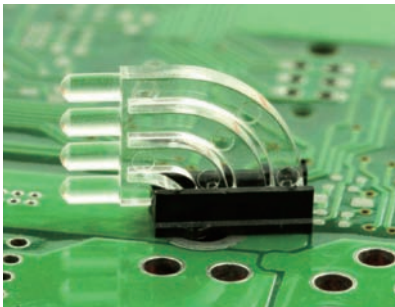

- Material: PC (UL)
- Holder Material: Nylon 66 (UL)
- Flame Class: 94V-2/94V-0
- Color: Transparent
- Holder Color: Black
- Unit: mm

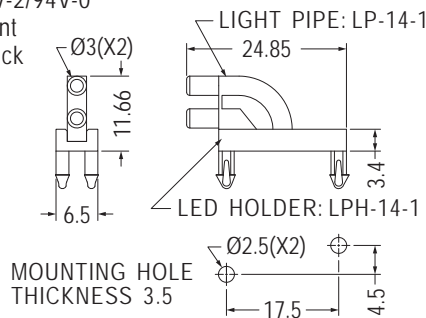

Part No.	Package
LP-14-1F	1000

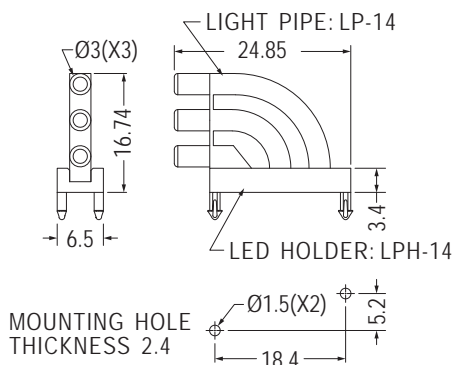

Part No.	Package
LP-14F	1000

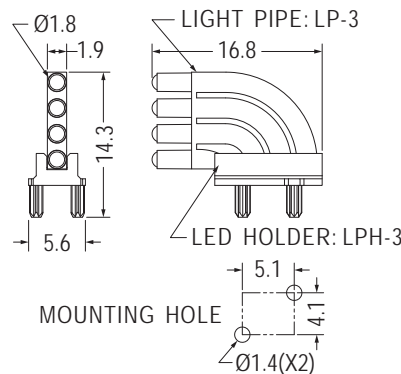

Part No.	Package
LP-3F	1000

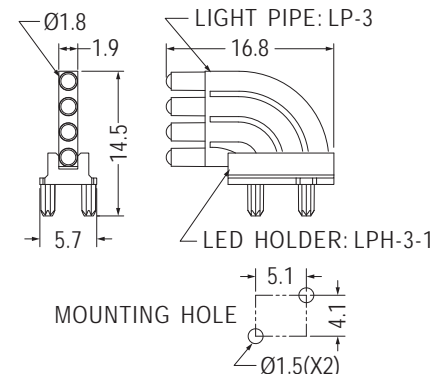

Part No.	Package
LP-3-1F	1000

LED導光柱 LIGHT PIPE

用途：置SMT LED導光於機殼面板上，使光度均勻、柔和。

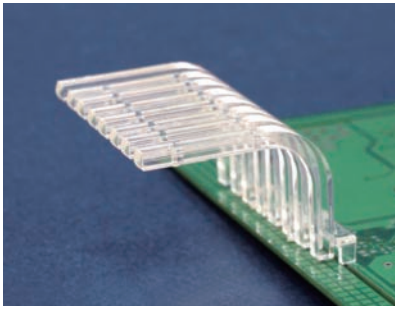

- Material: PC (UL)
- Flame Class: 94V-2/94V-0
- Color: Transparent
- Unit: mm

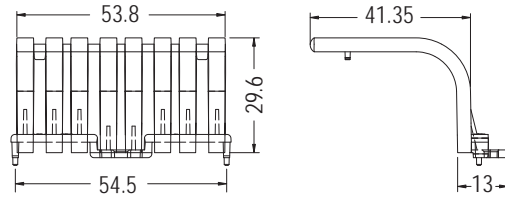

Part No.	Package
LEM-166	50

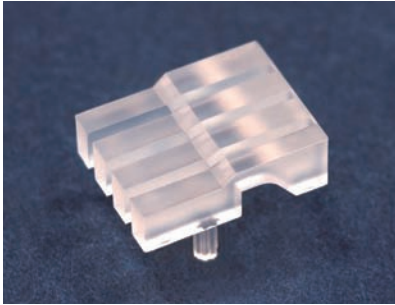

- Material: PMMA (UL)/PC (UL)
- Flame Class: 94HB/94V-2/94V-0
- Color: Transparent
- Unit: mm

用途：置LED導光於機殼面板上，使光度均勻、柔和。LPH-2B可遮蔽導光柱，免鄰近LED光線干擾，配合LP-2使用。

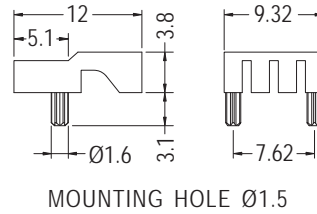

Part No.	Package
LP-2	2000



- Material: PC (UL)
- Flame Class: 94V-2
- Color: Black
- Unit: mm

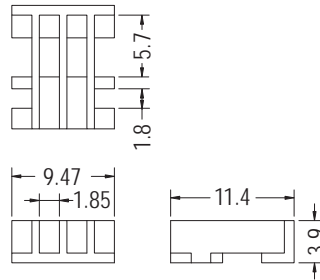

Part No.	Package
LPH-2B	2000



- Material: PMMA
- Color: Transparent
- Unit: mm

用途：用於LED導光柱。

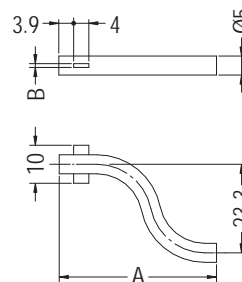

Part No.	A	B	Package
LPG-1	41.5	1.3	250
LPG-2	76.5	1.2	100



- Material: PC (UL)
- Flame Class: 94V-2/94V-0
- Color: Transparent
- Unit: mm

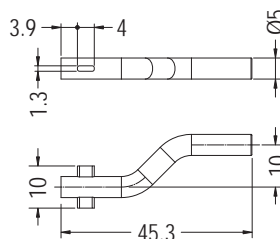

Part No.	Package
LPG-3	250

LED遮光罩 LIGHT PIPE MASK

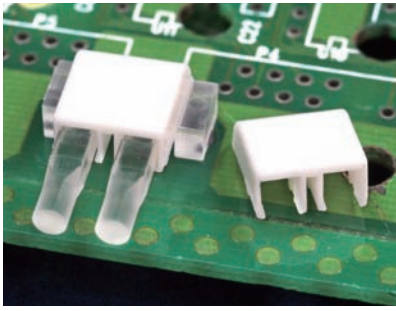

- Material: Nylon 66 (UL)
- Flame Class: 94V-2/94V-0
- Color: Natural/Black
- Unit: mm

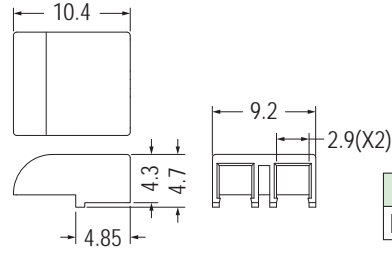

用途：遮蔽導光柱，避免鄰近LED光線干擾，搭配LPE2-5-19使用。

Part No.	Package
LPE2-5-19C	1000

2

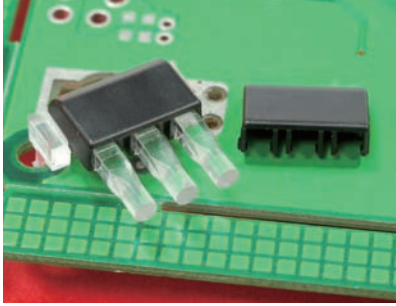

- Material: PC+ABS (UL)
- Flame Class: 94V-0
- Color: Black
- Unit: mm

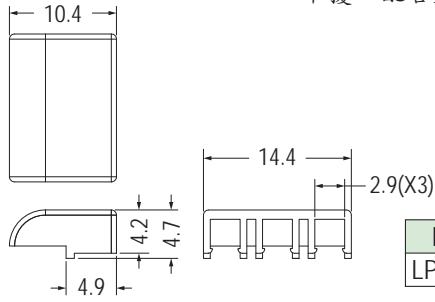

用途：遮蔽導光柱，避免鄰近LED光線干擾，配合LPE3-5-22使用。

Part No.	Package
LPE3-5-22C	1000

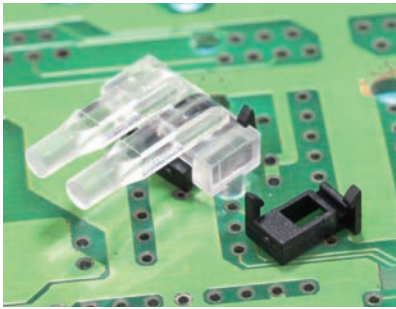

- Material: Nylon 66 (UL)
- Flame Class: 94V-2/94V-0
- Color: Black
- Unit: mm

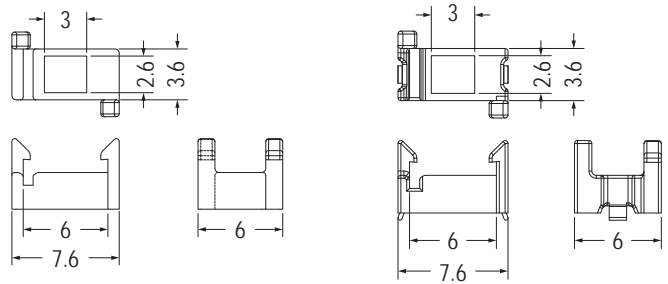

用途：遮蔽導光柱，避免鄰近LED光線干擾，配合LPE系列使用。

• Patented (專利品)

Part No.	Package
LPH-4	2000

Part No.	Package
LPH-4-1	2000

LED導光柱 LIGHT PIPE



- Material: PC (UL)
- Flame Class: 94V-2/94V-0
- Color: Transparent
- Unit: mm

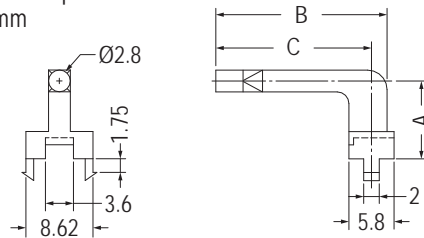

用途：置SMT LED導光於機殼面板上，使光度均勻、柔和。

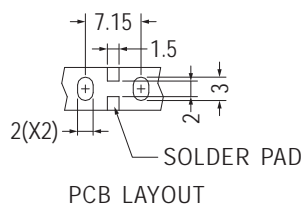

Part No.	A	B	C	Package
LPE1-5-16	5.0	16.0	14.0	1000
LPE1-5-19	5.0	19.0	17.0	
LPE1-5-22	5.0	22.0	20.0	
LPE1-10-16	10.0	16.0	14.0	
LPE1-10-19	10.0	19.0	17.0	
LPE1-10-22	10.0	22.0	20.0	
LPE1-10-26	10.0	27.0	25.0	
LPE1-15-16	15.0	16.0	14.0	
LPE1-15-19	15.0	19.0	17.0	
LPE1-15-22	15.0	22.0	20.0	

LED 導光柱 LIGHT PIPE

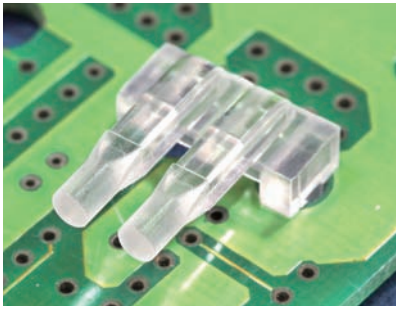

- Material: PC (UL)
- Flame Class: 94V-2/94V-0
- Color: Transparent
- Unit: mm

用途：置SMT LED導光於機殼面板上，使光度均勻、柔和。

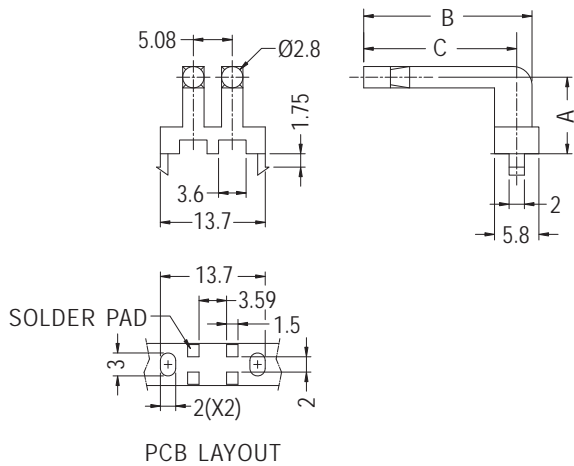

Part No.	A	B	C	Package
LPE2-5-16	5.0	16.0	14.0	1000
LPE2-5-19	5.0	19.0	17.0	
LPE2-5-22	5.0	22.0	20.0	
LPE2-10-16	10.0	16.0	14.0	
LPE2-10-19	10.0	19.0	17.0	
LPE2-10-22	10.0	22.0	20.0	
LPE2-15-16	15.0	16.0	14.0	
LPE2-15-19	15.0	19.0	17.0	
LPE2-15-22	15.0	22.0	20.0	

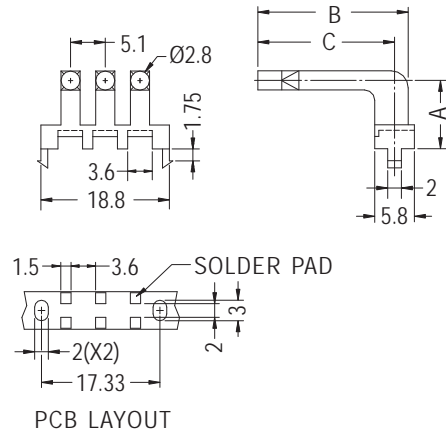

Part No.	A	B	C	Package
LPE3-5-14	5.0	14.0	12.0	500
LPE3-5-16	5.0	16.0	14.0	
LPE3-5-19	5.0	19.0	17.0	
LPE3-5-22	5.0	22.0	20.0	
LPE3-10-16	10.0	16.0	14.0	
LPE3-10-19	10.0	19.0	17.0	
LPE3-10-22	10.0	22.0	20.0	
LPE3-15-16	15.0	16.0	14.0	
LPE3-15-19	15.0	19.0	17.0	
LPE3-15-22	15.0	22.0	20.0	

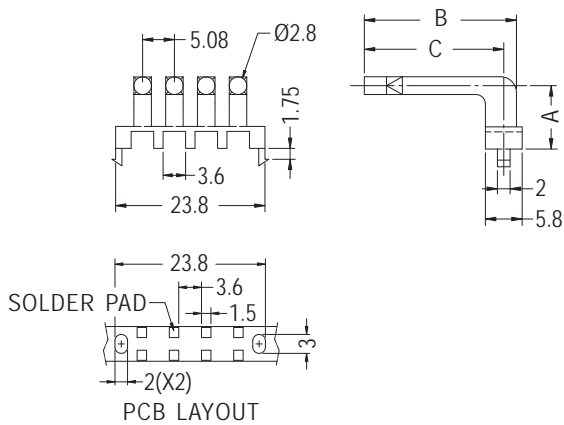

Part No.	A	B	C	Package
LPE4-5-18	5.0	18.0	16.0	100
LPE4-10-24	10.0	24.0	22.0	

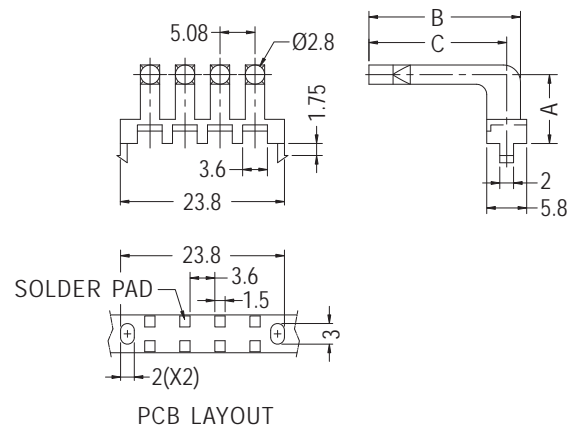

Part No.	A	B	C	Package
LPE4-5-16	5.0	16.0	14.0	500
LPE4-5-19	5.0	19.0	17.0	
LPE4-5-22	5.0	22.0	20.0	
LPE4-10-16	10.0	16.0	14.0	
LPE4-10-19	10.0	19.0	17.0	
LPE4-10-22	10.0	22.0	20.0	
LPE4-15-16	15.0	16.0	14.0	
LPE4-15-19	15.0	19.0	17.0	
LPE4-15-22	15.0	22.0	20.0	

LED 導光柱 LIGHT PIPE



- Material: PC (UL)
- Flame Class: 94V-2/94V-0
- Color: Transparent
- Unit: mm

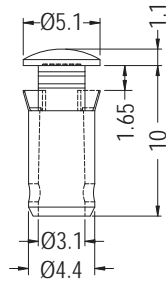

MOUNTING HOLE Ø4.5
THICKNESS 1.6

Part No.	Package
LEU-4	1000

用途：可配合光纖將LED光導到機器面板。

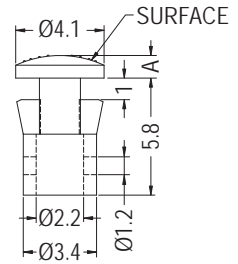

MOUNTING HOLE Ø3.5
THICKNESS 0.8-1.0

Part No.	A	Surface	Package
LEU-1	1.1	Bright	2000
LEU-2	1.05	Matte	

光纖座 OPTICAL FIBER MOUNT



- Material: Nylon 66 (UL)
- Flame Class: 94V-2/94V-0
- Color: Black
- Unit: mm

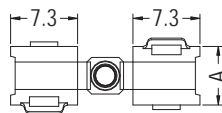
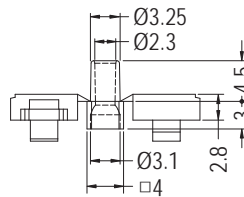

用途：配合光纖及LEU-1將LED光導到機器面板。

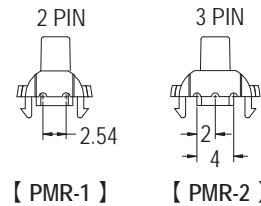

Part No.	A	Package
PMR-1	6.4	2000
PMR-2	7.86	



- Material: Nylon 66 (UL)
- Flame Class: 94V-2/94V-0
- Color: Black
- Unit: mm

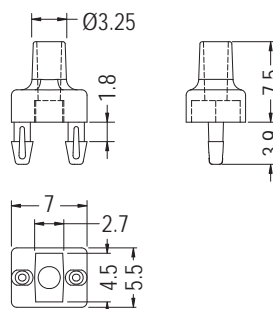

用途：配合光纖將SMT LED光導到機器面板。

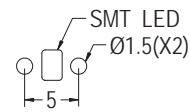

MOUNTING HOLE
THICKNESS 1.6

Part No.	Package
PMR-3	2000

光纖座 OPTICAL FIBER MOUNT

用途：配合光纖將SMT LED光導到機器面板。

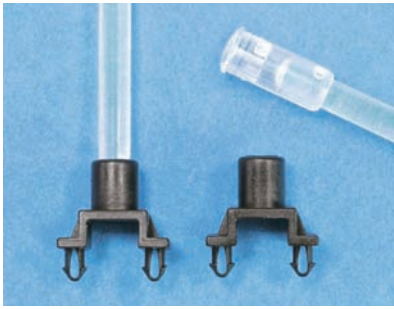

- Material: Nylon 66 (UL)
- Flame Class: 94V-2/94V-0
- Color: Black
- Unit: mm

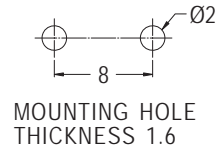
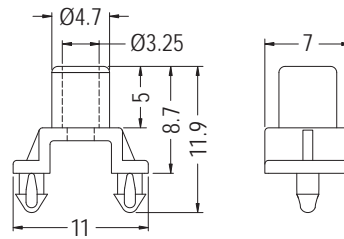

Part No.	Package
PMR-10	1000

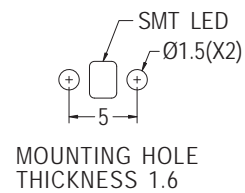
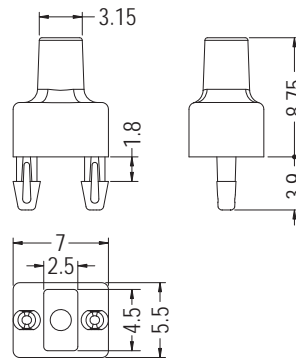
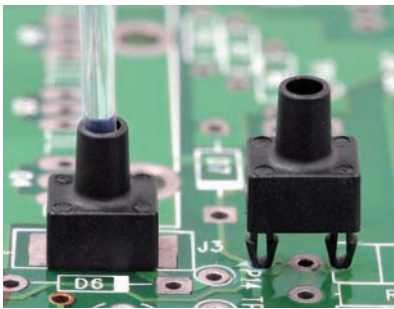

Part No.	Package
PMR-13	2000



- Material: Nylon 66 (UL)
- Flame Class: 94V-2/94V-0
- Color: Black
- Unit: mm

用途：配合光纖將LED光導到機器面板。

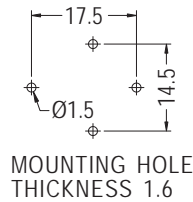
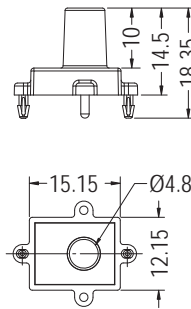

Part No.	Package
PMR-6	2000

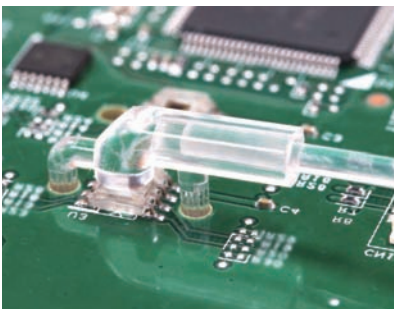

- Material: PC (UL)
- Flame Class: 94V-2/94V-0
- Color: Transparent
- Unit: mm

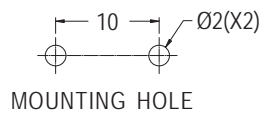
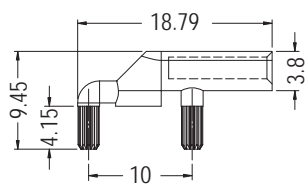

Part No.	Package
PMR-11	1000

光纖座 OPTICAL FIBER MOUNT

用途：配合光纖將LED光導到機器面板。

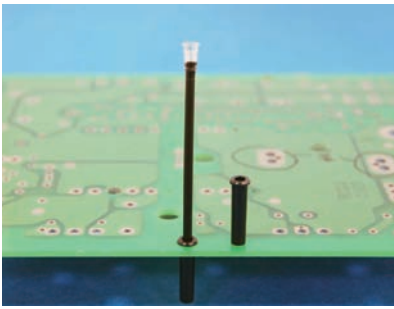

- Material: Nylon 66 (UL)
- Flame Class: 94V-2/94V-0
- Color: Black
- Unit: mm

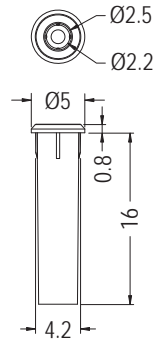

MOUNTING HOLE Ø4.0

Part No.	Package
PMR-14	1000

2

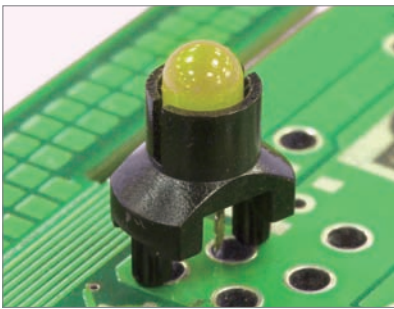

- Material: PC (UL)
- Flame Class: 94V-2/94V-0
- Color: Natural/Black
- Unit: mm

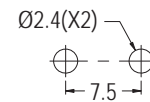
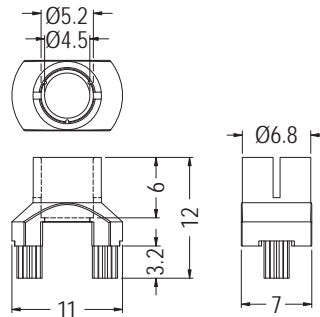

MOUNTING HOLE

Part No.	Package
PMR-7	1000

LED座 LED HOLDER

用途：可快速將LED固定於PC板上。



- Material: Nylon 66 (UL)
- Flame Class: 94V-2/94V-0
- Color: Black
- Unit: mm

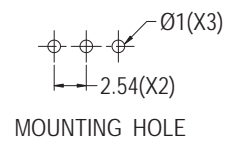
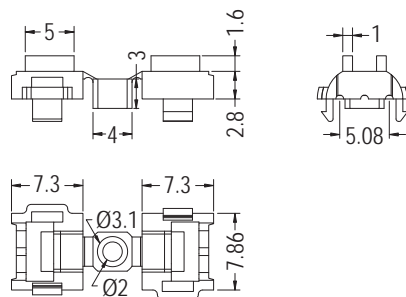

MOUNTING HOLE

Part No.	Package
PMR-8	1000

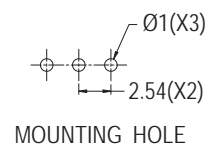
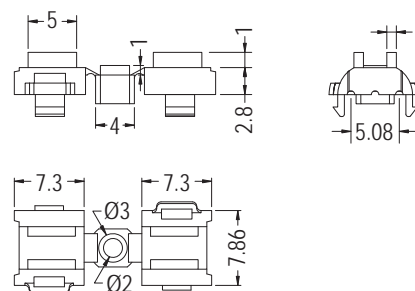
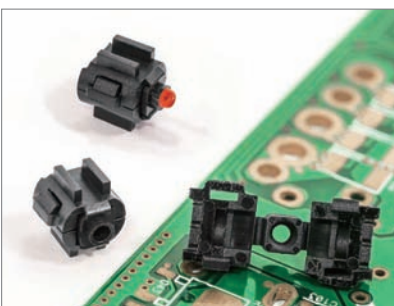

MOUNTING HOLE

Part No.	Package
PMR-15	1000

3

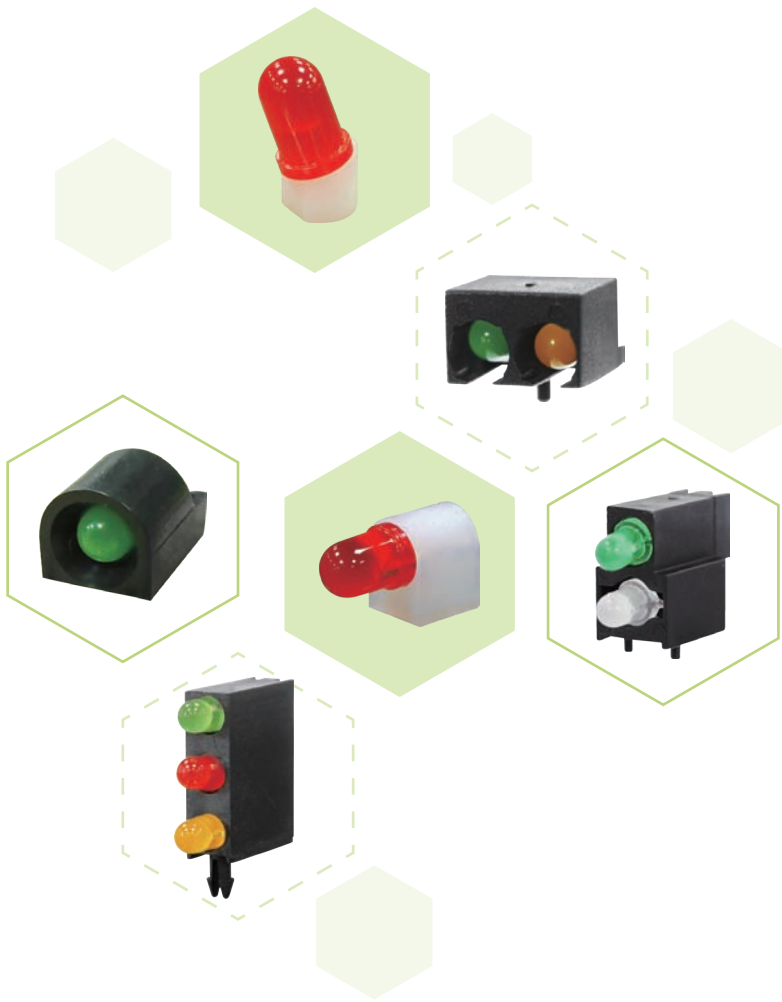

- 90° LED燈座
- 90° LED Holder



90° LED燈座 90° LED HOLDER

用途：使 $\varnothing 3$ mm LED成90°焊於PC板上，高度一致，不斷腳。

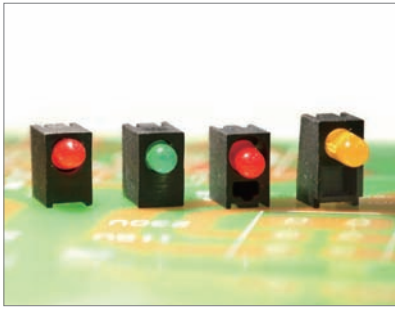

- Material: Nylon 66 (UL)
- Flame Class: 94V-2/94V-0
- Color: Black
- Unit: mm

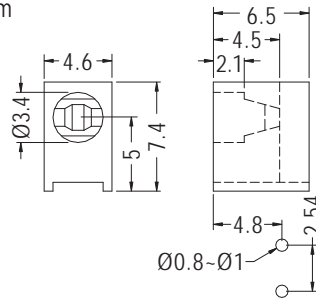

MOUNTING HOLE

Part No.	Package
LED-301	2000

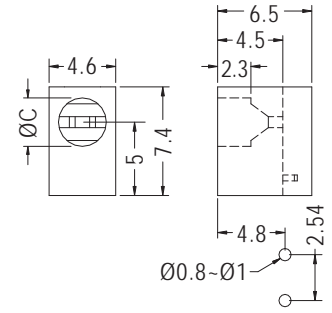

MOUNTING HOLE

Part No.	C	Package
LED-301A	3.4	2000
LED-301(B)	3.3	

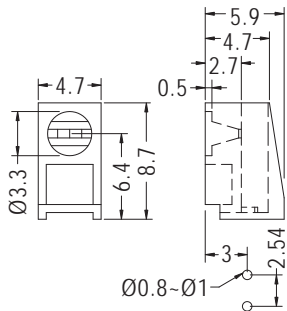

MOUNTING HOLE

Part No.	Package
LED-312	2000

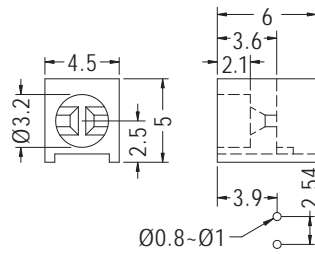

MOUNTING HOLE

Part No.	Package
LED-313	2000

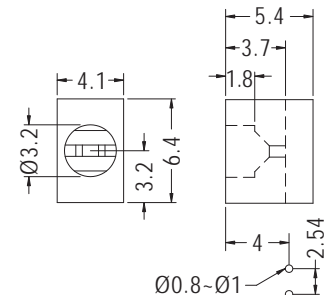

MOUNTING HOLE

Part No.	Package
LED-314	2000

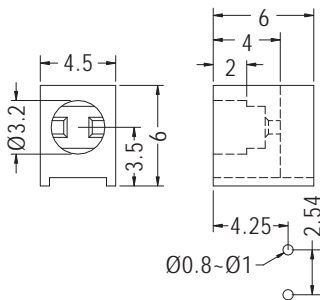

MOUNTING HOLE

Part No.	Package
LED-316	2000

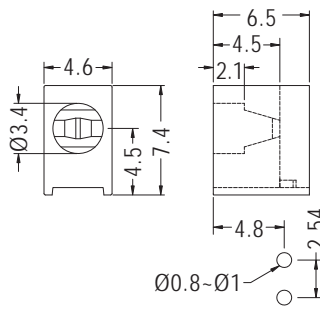

MOUNTING HOLE

Part No.	Package
LED-326	1000

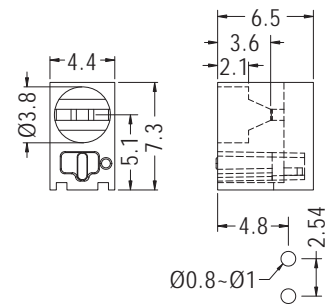

MOUNTING HOLE

Part No.	Package
LED-328	1000

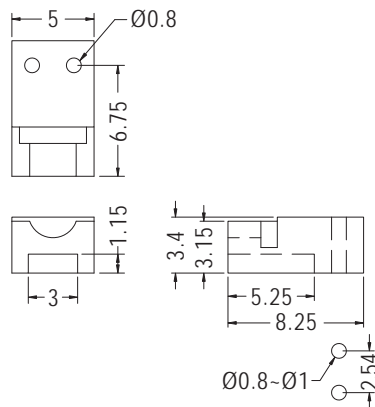
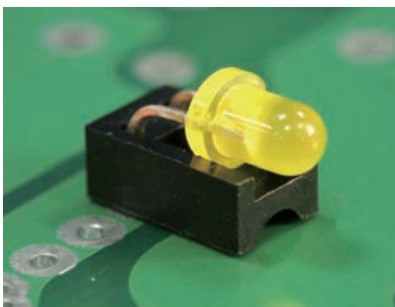

MOUNTING HOLE

Part No.	Package
LED-325	1000

90° LED燈座 90° LED HOLDER

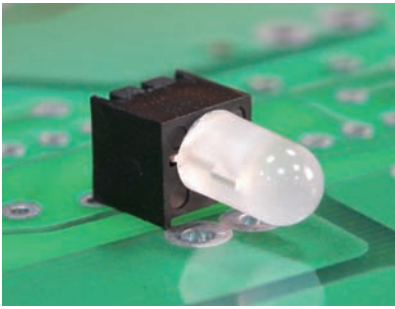

- Material: Nylon 66 (UL)
- Flame Class: 94V-2/94V-0
- Color: Black
- Unit: mm

用途：使 $\varnothing 3$ mm 3 PIN LED成90°焊於PC板上，高度一致，不斷腳。

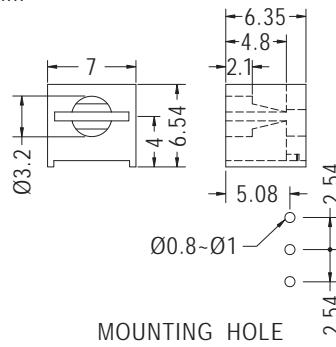

Part No.	Package
LED-343	1000

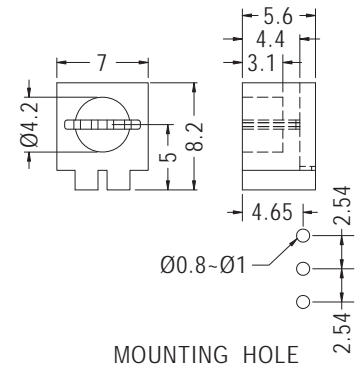

Part No.	Package
LED-319	1000

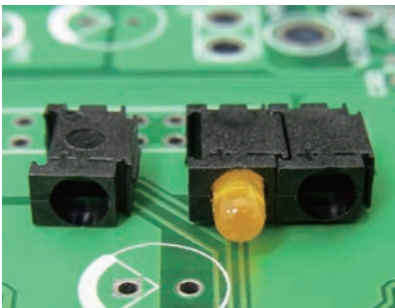

- Material: Nylon 66 (UL)
- Flame Class: 94V-2/94V-0
- Color: Black
- Unit: mm

用途：使 $\varnothing 3$ mm LED成90°焊於PC板上，高度一致，不斷腳，可組合使用。

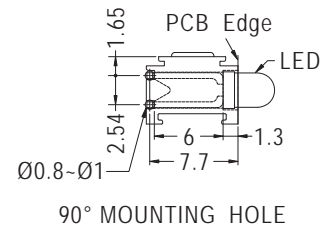
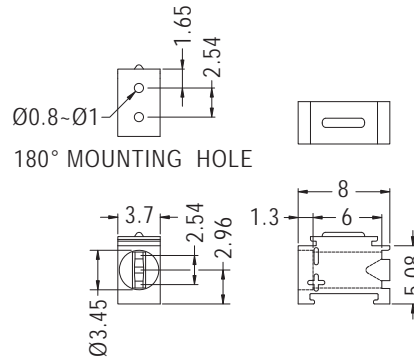

Part No.	Package
LED-344	1000

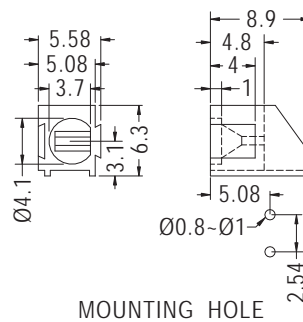
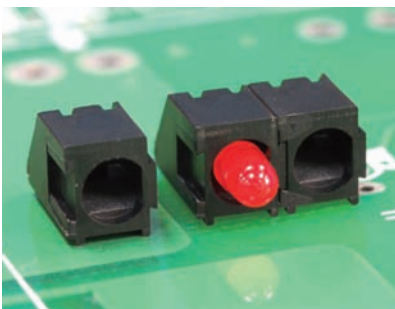

Part No.	Package
LED-6301	2000



- Material: ABS
- Color: Black
- Unit: mm

用途：可快速將 $\varnothing 3$ mm LED固定於機器面板上。

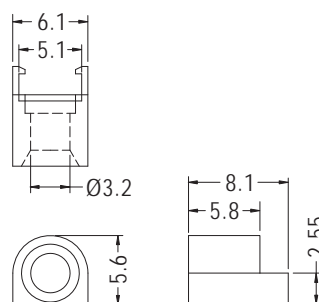

Part No.	Package
LED3-21	2000

LED燈座 LED MOUNT

用途：使 $\varnothing 3$ mm LED成斜角焊於PC板上，高度一致，不斷腳。

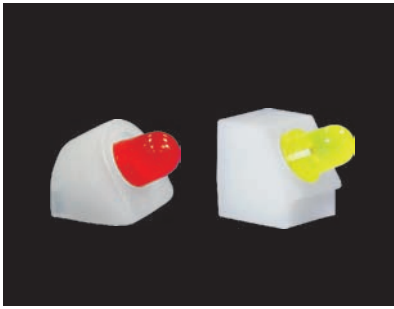

- Material: Nylon 66 (UL)
- Flame Class: 94V-2/94V-0
- Color: Natural/Black
- Unit: mm

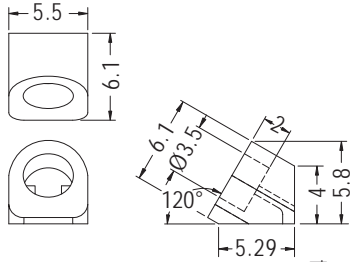

$\varnothing 0.8-\varnothing 1$
MOUNTING HOLE

Part No.	Package
LEDA-5	1000

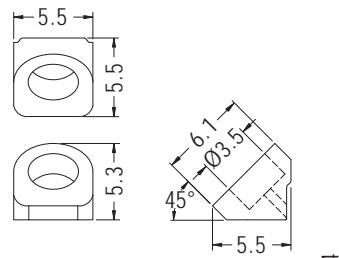

$\varnothing 0.8-\varnothing 1$
MOUNTING HOLE

Part No.	Package
LEDA-6	1000

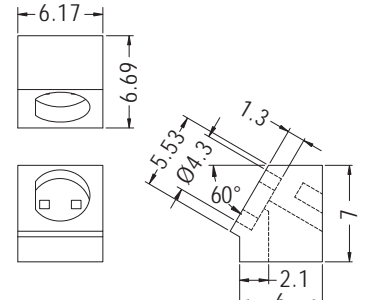

$\varnothing 0.8-\varnothing 1$
MOUNTING HOLE

Part No.	Package
LEDA-4	1000

90° LED燈座 90° LED HOLDER

用途：使 $\varnothing 3$ mm LED成90°焊於PC板上，高度一致，有定位腳，不傾斜。



- Material: Nylon 66 (UL)
- Flame Class: 94V-2/94V-0
- Color: Black
- Unit: mm

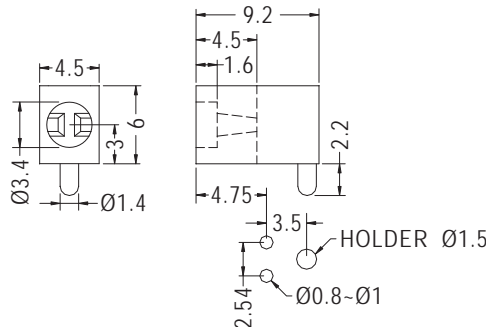

MOUNTING HOLE

Part No.	Package
LEK-301	1000

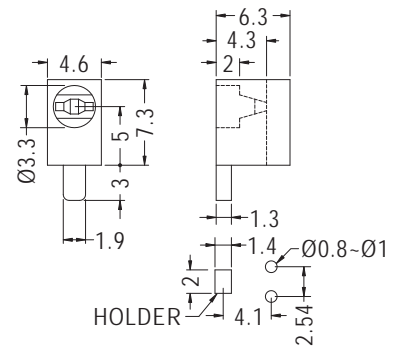

MOUNTING HOLE

Part No.	Package
LEK-302	1000

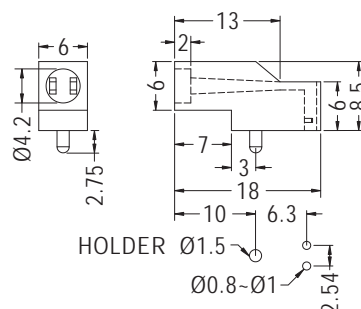
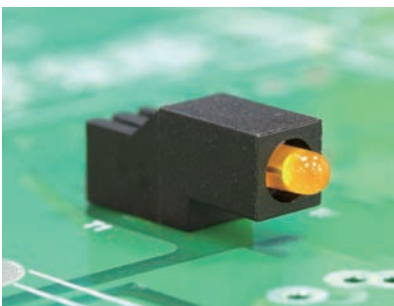

MOUNTING HOLE

Part No.	Package
LEK-311	1000

90° LED燈座 90° LED HOLDER

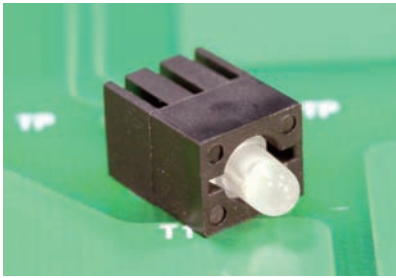

- Material: Nylon 66 (UL)
- Flame Class: 94V-2/94V-0
- Color: Black
- Unit: mm

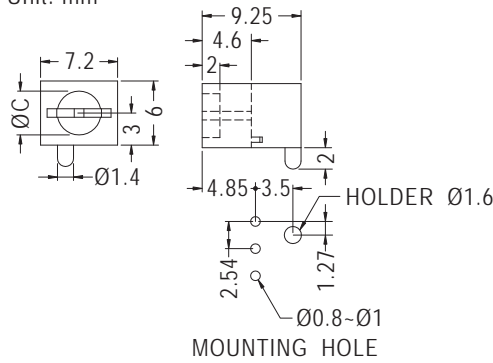

Part No.	C	Package
LEK-303	4.1	1000
LEK-303L	4.25	

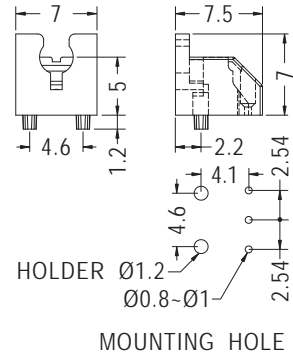

Part No.	Package
LEJ3-5	1000

用途：使Ø3 mm 3 PIN LED成90°焊於PC板上，高度一致，有定位腳，不傾斜。

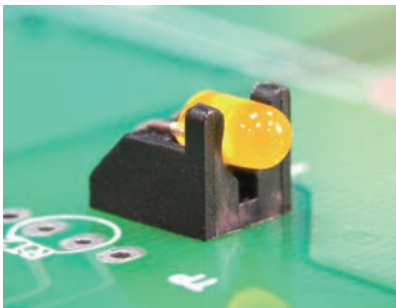

- Material: Nylon 66 (UL)/ABS (UL)
- Flame Class: 94HB/94V-2/94V-0
- Color: Black
- Unit: mm

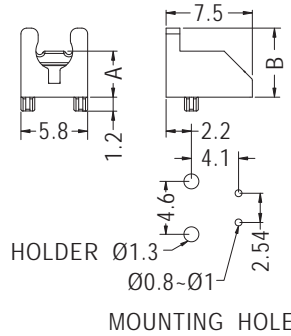

用途：使Ø3 mm LED成90°焊於PC板上，高度一致，有定位腳，不傾斜。

Part No.	A	B	Package
LEJ-4	4.0	6.0	1000
LEJ-5	5.0	7.0	
LEJ-6	6.0	8.0	
LEJ-7	7.0	9.0	
LEJ-8	8.0	10.0	
LEJ-9	9.0	11.0	
LEJ-13	13.0	15.0	

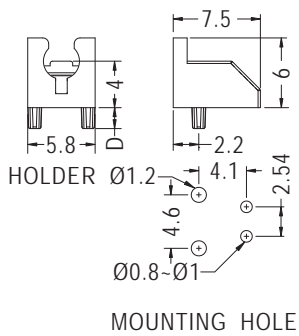

Part No.	D	Package
LEJ-4S	1.8	1000
LEJ-4M	3.0	

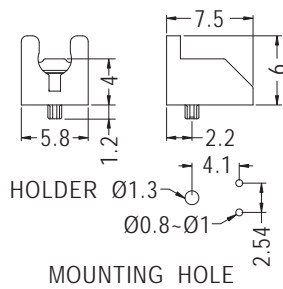

- Material: PC+ABS (UL)
- Flame Class: 94V-2/94V-0

Part No.	Package
LEJT-4	1000

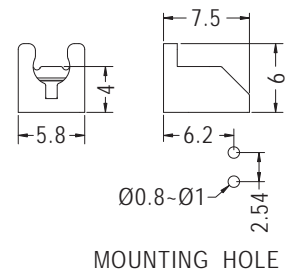

• 底部無定位腳

Part No.	Package
LEJN-4	1000

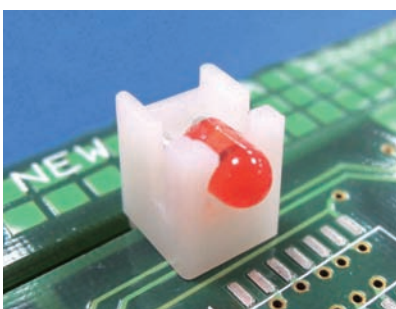

- Material: ABS (UL)
- Flame Class: 94HB
- Color: Natural
- Unit: mm

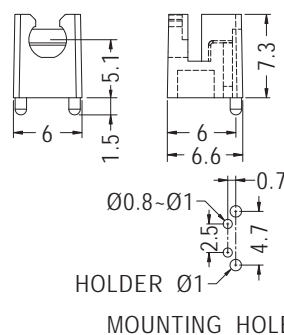

Part No.	Package
LEJA-5	2000

90° LED燈座 90° LED HOLDER

用途：使Ø3 mm LED成90°焊於PC板上，高度一致，有定位腳，不傾斜。



- Material: Nylon 66 (UL)
- Flame Class: 94V-2/94V-0
- Color: Natural/Black
- Unit: mm

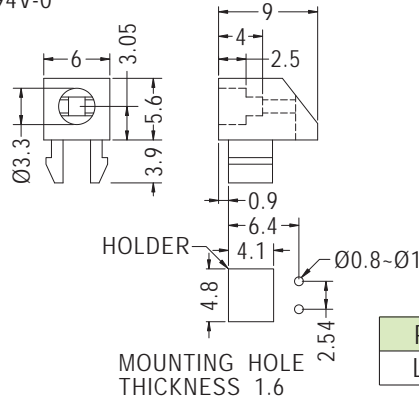

Part No.	Package
LEK-314	1000

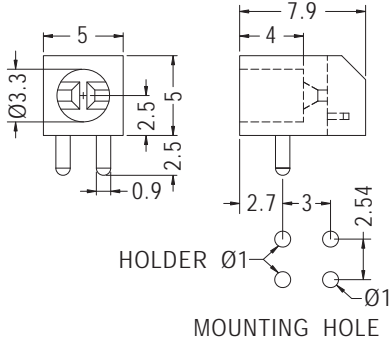

Part No.	Package
LEK-3111	1000

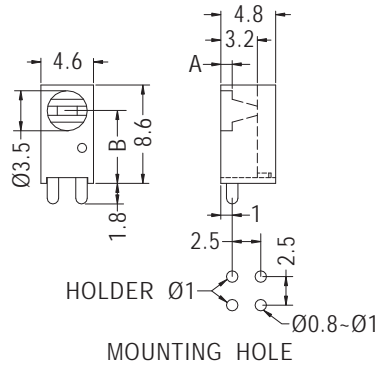

Part No.	A	B	Package
LEK-304	1.0	6.4	1000
LEK-310	2.0	6.35	

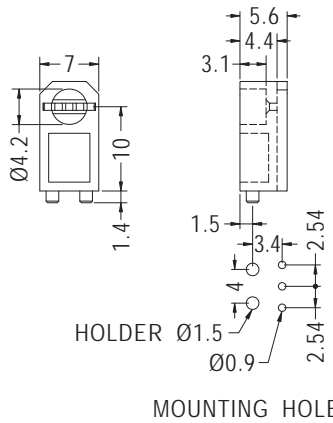

Part No.	Package
LEK-555	1000

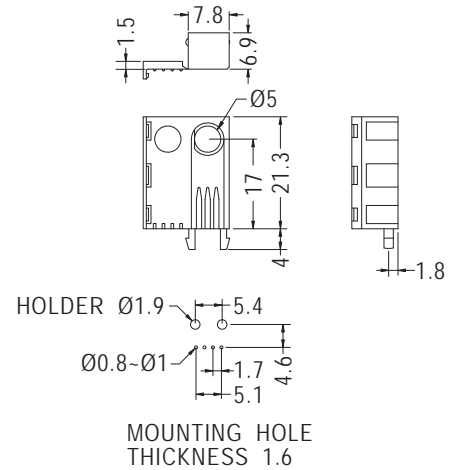

Part No.	Package
LEK54-17	1000

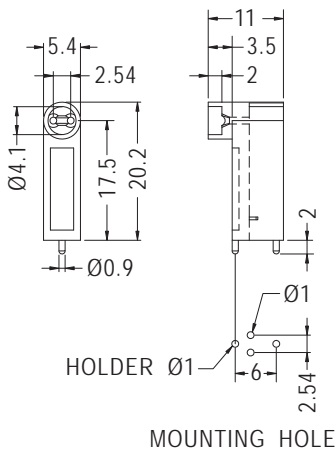

Part No.	Package
LEAK-17.5	1000

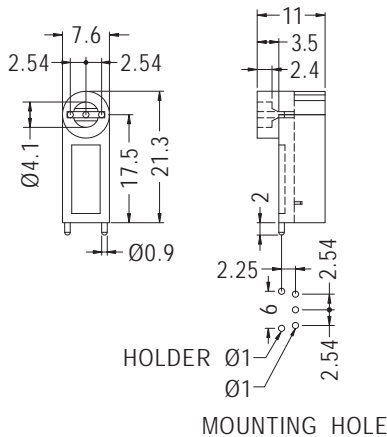

Part No.	Package
LEAK3-17.5	1000

• FOR 3 PIN LED

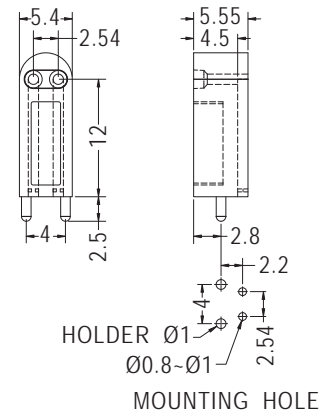

Part No.	Package
LEKH-12	1000

90° LED燈座 90° LED HOLDER

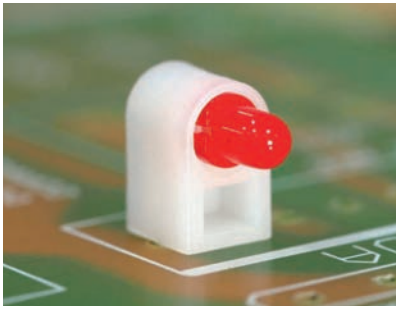

- Material: Nylon 66 (UL)
- Flame Class: 94V-2/94V-0
- Color: Natural/Black
- Unit: mm

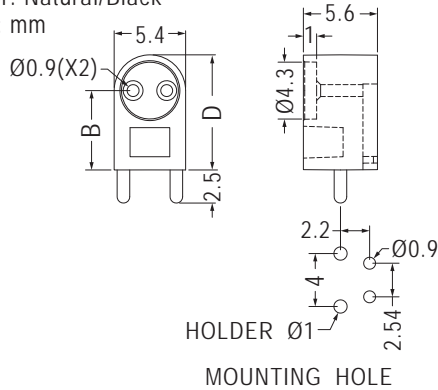

用途：使 $\varnothing 3$ mm LED成90°焊於PC板上，高度一致，有定位腳，不傾斜。

Part No.	B	D	Package
LEK-349	6.0	8.7	1000
LEK-350	8.0	10.7	



- Material: Nylon 66 (UL)
- Flame Class: 94V-2/94V-0
- Color: Black
- Unit: mm

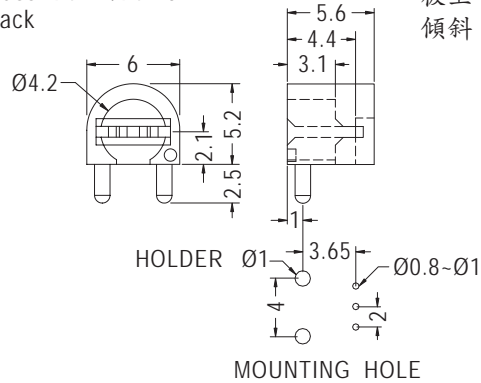

用途：使 $\varnothing 3$ mm 3 PIN LED成90°焊於PC板上，高度一致，有定位腳，不傾斜。

Part No.	Package
LEK-312	1000

LED燈座 LED MOUNT

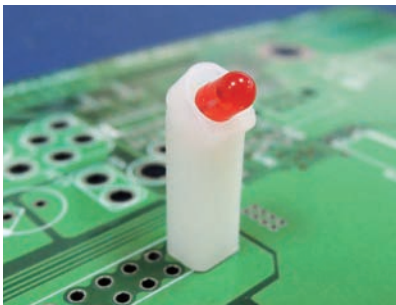

- Material: Nylon 66 (UL)
- Flame Class: 94V-2/94V-0
- Color: Natural/Black
- Unit: mm

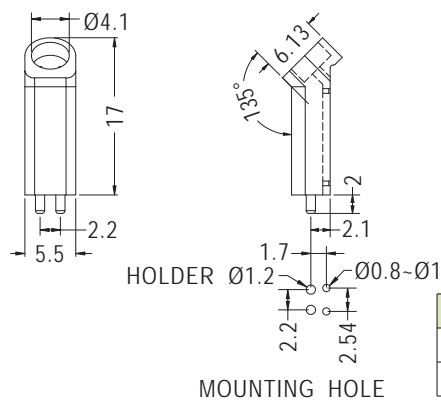

用途：使 $\varnothing 3$ mm LED成斜角焊於PC板上，高度一致，有定位腳，不傾斜。

【LEDA-17-1】

Part No.	A	B	Package
LEDA-17	/	/	1000
LEDA-17-1	5.0	2.0	

90° LED燈座 90° LED HOLDER

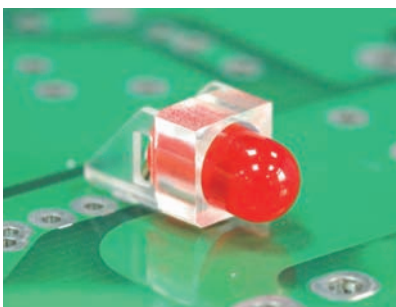

- Material: PC (UL)
- Flame Class: 94V-2
- Color: Transparent
- Unit: mm

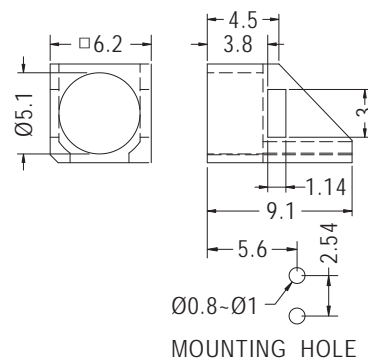

用途：使 $\varnothing 5$ mm有帽沿LED成90°焊於PC板上，高度一致，不斷腳。

Part No.	Package
LED-505	1000

90° LED燈座 90° LED HOLDER

用途：使Ø5 mm LED成90°焊於PC板上，高度一致，不斷腳。



- Material: Nylon 66 (UL)
- Flame Class: 94V-2/94V-0
- Color: Black
- Unit: mm

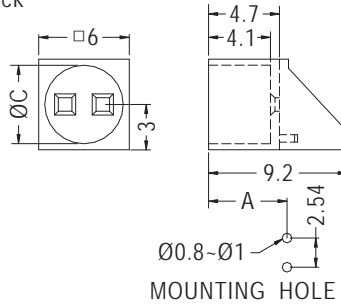

Part No.	A	C	Package
LED-502	4.95	5.2	2000
LED-502S	5.0	4.9	

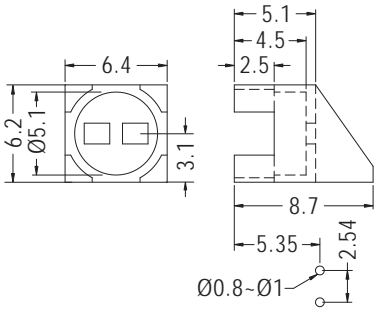

Part No.	Package
LED1L-2.5	2000

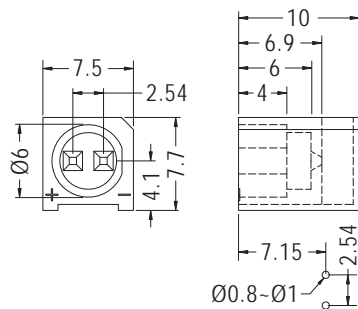

Part No.	Package
LED-542	1000

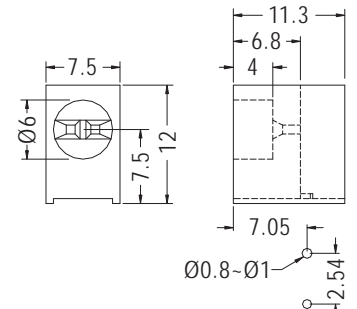

Part No.	Package
LED-504	1000

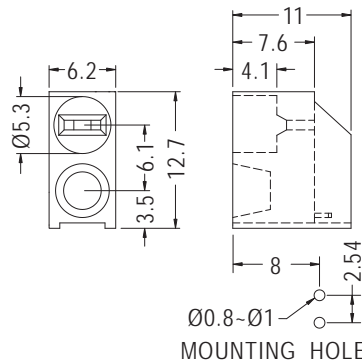
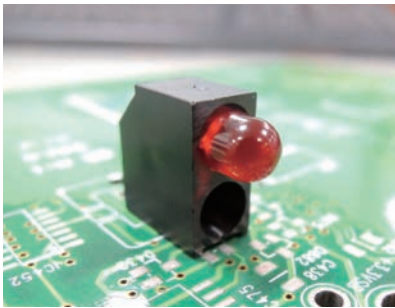

Part No.	Package
LED-528	1000

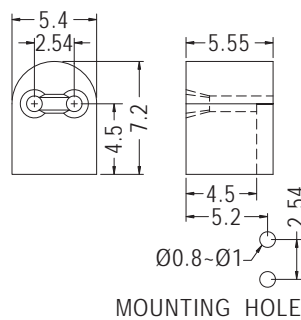
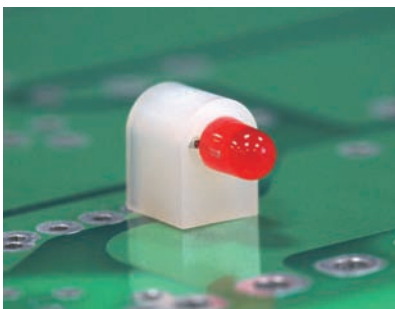

• Color: Natural/Black

Part No.	Package
LEAH-4.5	2000



- Material: PC (UL)
- Flame Class: 94V-2
- Color: Black
- Unit: mm

用途：使Ø5 mm 3 PIN LED成90°焊於PC板上，高度一致，不斷腳。

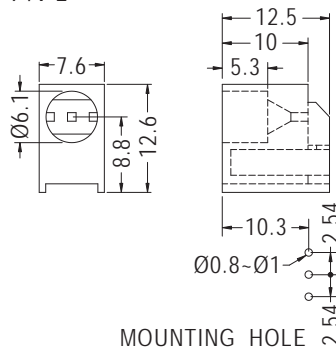

Part No.	Package
LED-535	500

90° LED燈座 90° LED HOLDER



- Material: Nylon 66 (UL)
- Flame Class: 94V-2/94V-0
- Color: Black
- Unit: mm

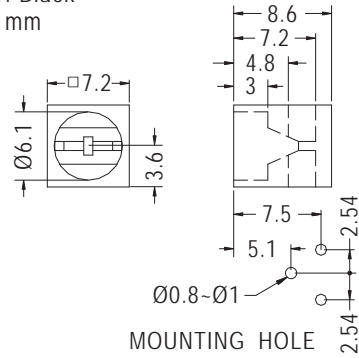

Part No.	Package
LED-503	1000

用途：使 $\varnothing 5$ mm 3 PIN LED成90°焊於PC板上，高度一致，不斷腳。

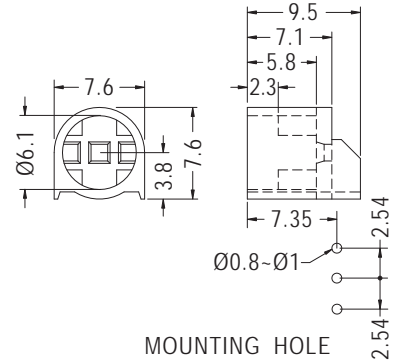

Part No.	Package
LED-501	1000

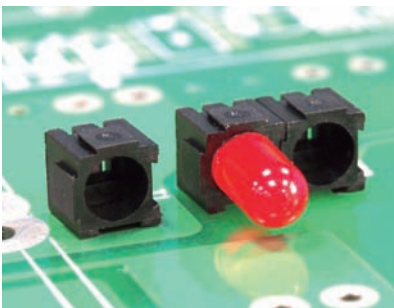

- Material: Nylon 66 (UL)
- Flame Class: 94V-2/94V-0
- Color: Black
- Unit: mm

用途：使 $\varnothing 5$ mm LED成90°焊於PC板上，高度一致，不斷腳，可組合使用。

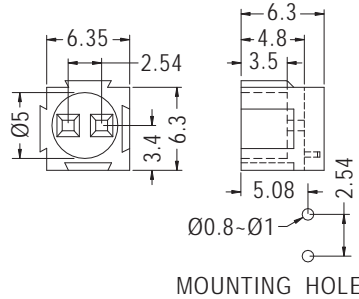

Part No.	Package
LED-6501	2000

LED燈座 LED MOUNT

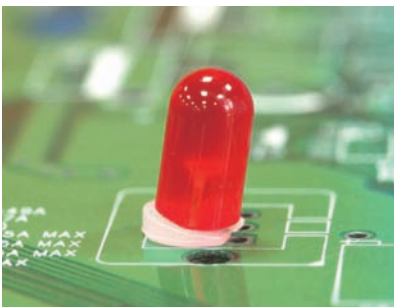

- Material: Nylon 66 (UL)
- Flame Class: 94V-2/94V-0
- Color: Natural/Black
- Unit: mm

用途：使 $\varnothing 5$ mm LED成斜角焊於PC板上，高度一致，不斷腳。

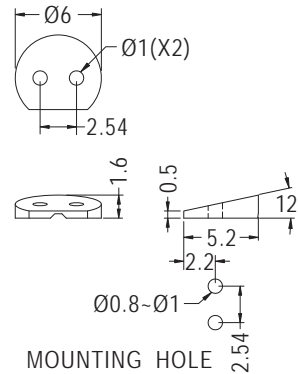

Part No.	Package
LEDA-7	1000

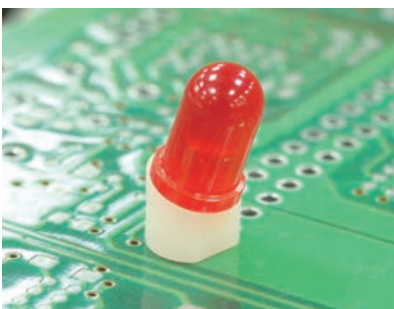

- Material: Nylon 66 (UL)/ABS (UL)
- Flame Class: 94HB/94V-2/94V-0
- Color: Natural/Black
- Unit: mm

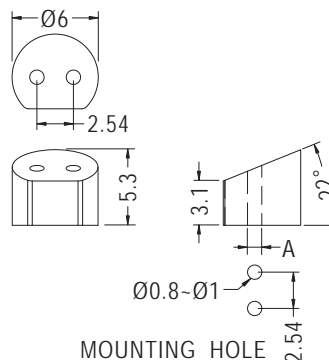

Part No.	A	Package
LEDA-2S	0.9	1000
LEDA-2	1.0	

LED燈座 LED MOUNT



- Material: Nylon 66 (UL)/ABS (UL)
- Flame Class: 94HB/94V-2/94V-0
- Color: Natural/Black
- Unit: mm

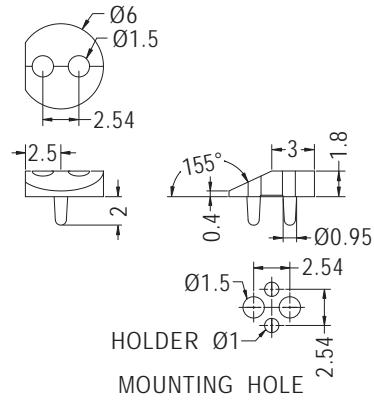

Part No.	Package
LEK-530	1000

- Material: Nylon 66 (UL)
- Flame Class: 94V-2/94V-0
- Color: Natural/Black
- Unit: mm

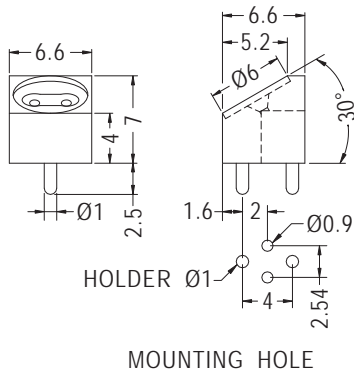

Part No.	Package
LEK-513	2000

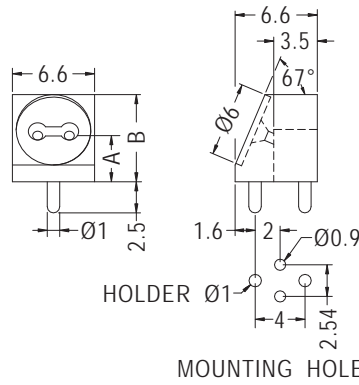

Part No.	A	B	Package
LEK-509	3.0	7.0	1000
LEK-531	7.0	10.3	

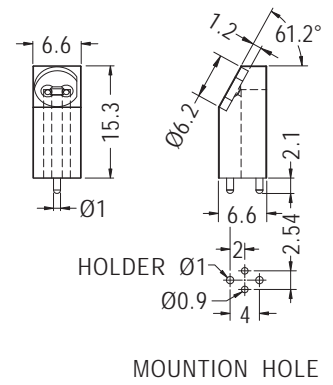

Part No.	Package
LEK-545	1000

90° LED燈座 90° LED HOLDER



- Material: Nylon 66 (UL)
- Flame Class: 94V-2/94V-0
- Color: Black
- Unit: mm

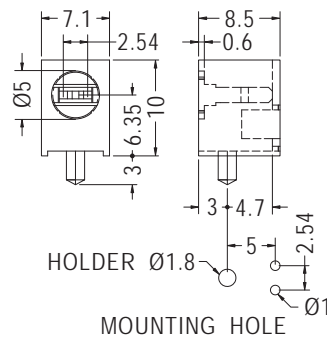

Part No.	Package
LEK-541	1000

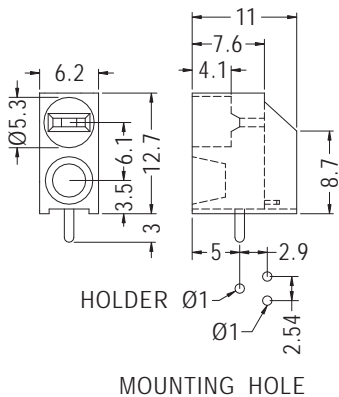

Part No.	Package
LEK-525	1000

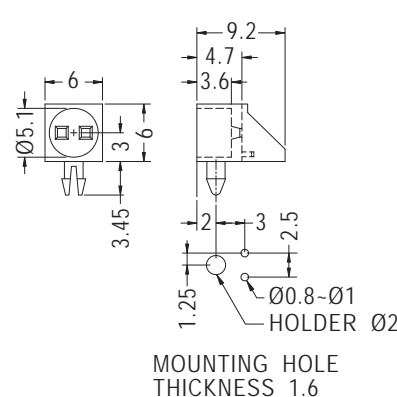

Part No.	Package
LEK-548	1000

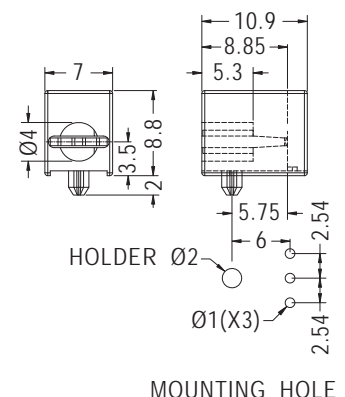

Part No.	Package
LEK-551	1000

用途：使 $\varnothing 5$ mm LED成斜角焊於PC板上，高度一致，有定位腳，不傾斜。

用途：使 $\varnothing 5$ mm LED成90°焊於PC板上，高度一致，有定位腳，不傾斜。

90° LED燈座 90° LED HOLDER

用途：使 $\varnothing 5$ mm LED成90°焊於PC板上，高度一致，有定位腳，不傾斜。



- Material: POM
- Color: Natural/Black
- Unit: mm

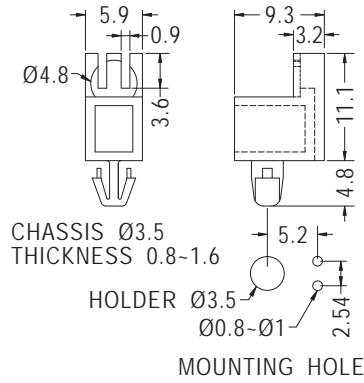

Part No.	Package
LEK-526	1000



- Material: Nylon 66 (UL)
- Flame Class: 94V-2/94V-0
- Color: Black
- Unit: mm

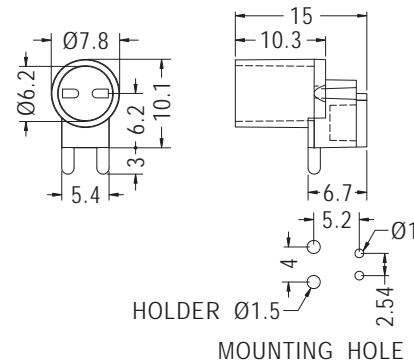

Part No.	Package
LEK-539	1000

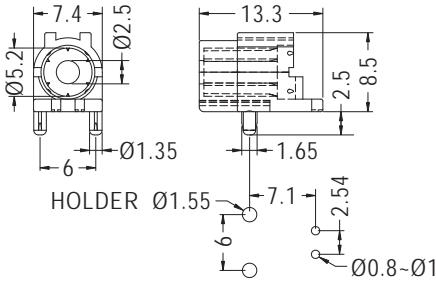

Part No.	Package
LEK-533	1000

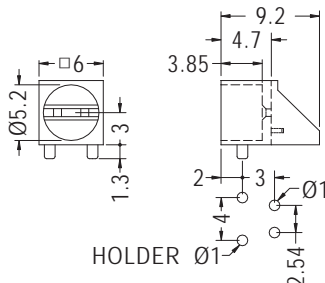

Part No.	Package
LEK-516	2000

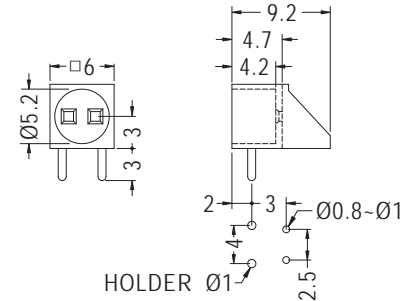

Part No.	Package
LEK-502	1000

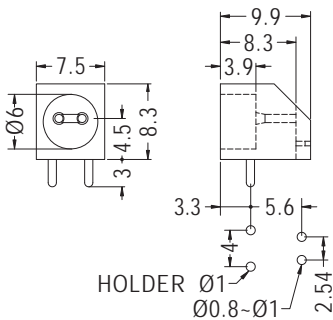

Part No.	Package
LEK-535	1000

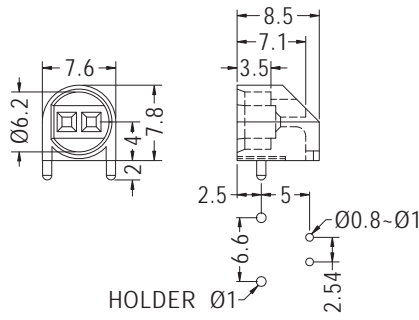

Part No.	Package
LEK-534	1000

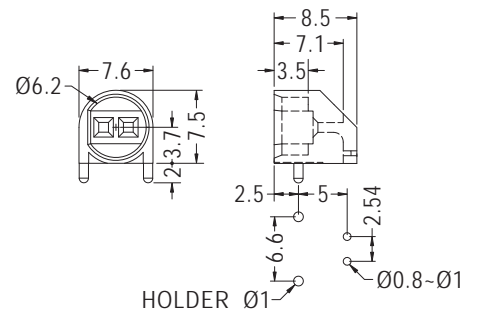

Part No.	Package
LEK-547	1000

90° LED燈座 90° LED HOLDER



- Material: Nylon 66 (UL)
- Flame Class: 94V-2/94V-0
- Color: Black
- Unit: mm

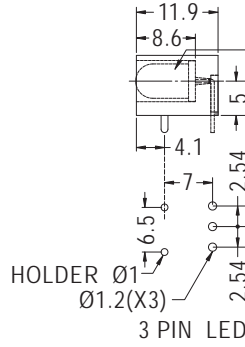
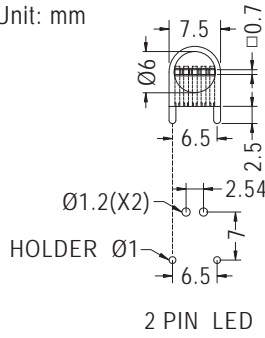

LED組裝示意圖
ASSEMBLY DIAGRAM

Part No.	Package
LEK-528	1000

MOUNTING HOLE

用途：用於Ø5 mm 2或3 PIN LED成90°焊於PC板上，高度一致，有定位腳，不傾斜。

3



- Material: Nylon 66 (UL)
- Flame Class: 94V-2/94V-0
- Color: Black
- Unit: mm

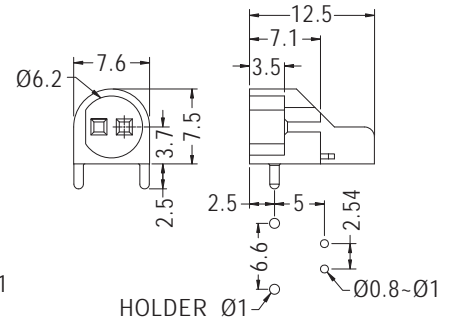
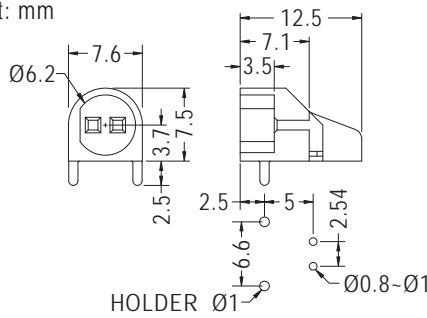

Part No.	Package
LEK-560	1000

Part No.	Package
LEK-561	1000

MOUNTING HOLE

MOUNTING HOLE

用途：使Ø5 mm LED成90°焊於PC板上，高度一致，有定位腳，不傾斜。



- Material: Nylon 66 (UL)
- Flame Class: 94V-2/94V-0
- Color: Natural/Black
- Unit: mm

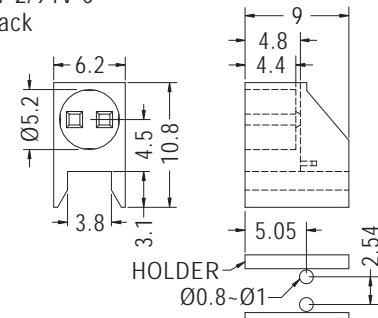

Part No.	Package
LEK-507	1000

MOUNTING HOLE

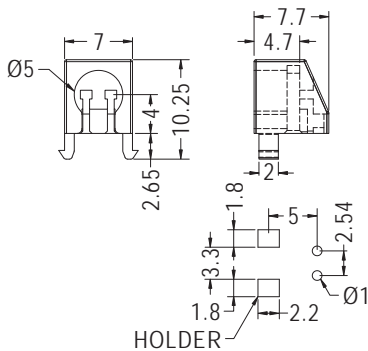

Part No.	Package
LEJB-4	1000

MOUNTING HOLE THICKNESS 1.6

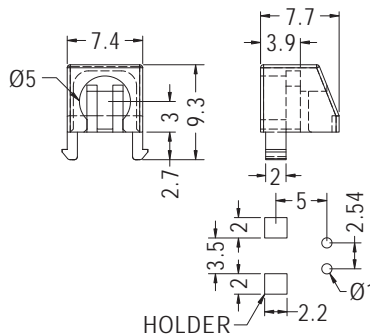

Part No.	Package
LEK-549	1000

MOUNTING HOLE THICKNESS 1.6

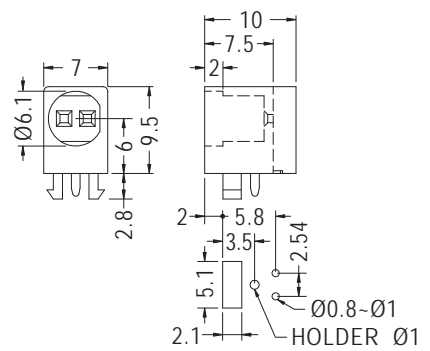

Part No.	Package
LEK-506	1000

MOUNTING HOLE THICKNESS 1.6

90° LED燈座 90° LED HOLDER



- Material: Nylon 66 (UL)
- Flame Class: 94V-2/94V-0
- Color: Natural/Black
- Unit: mm

用途：使 $\varnothing 5$ mm 3 PIN LED成90°焊於PC板上，高度一致，有定位腳，不傾斜。

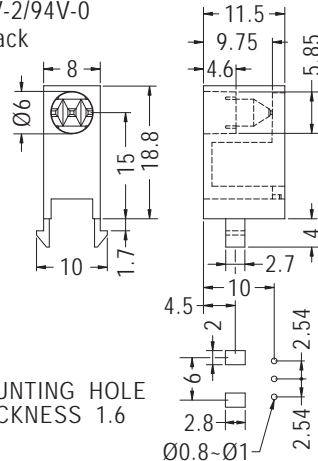

MOUNTING HOLE THICKNESS 1.6

Part No.	Package
LEK-517	1000

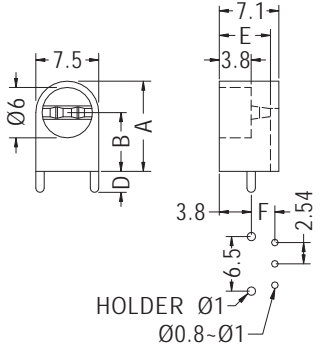

MOUNTING HOLE

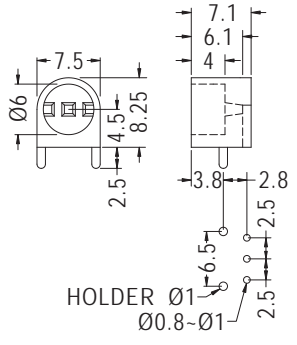

MOUNTING HOLE

Part No.	A	B	D	E	F	Package
LEK503-7	10.75	7.0	2.5	6.1	2.8	1000
LEK503-18	21.75	18.0	3.1	5.9	2.6	

Part No.	Package
LEK-503	1000

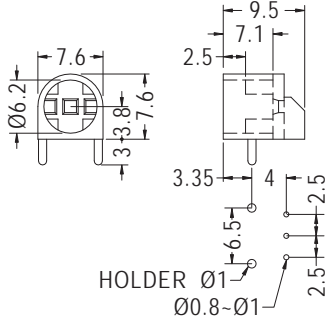

MOUNTING HOLE

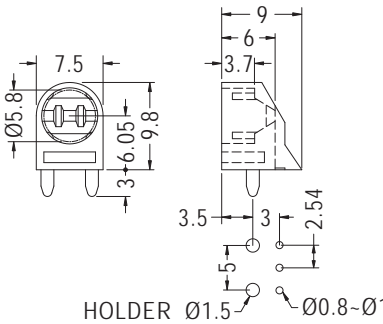

MOUNTING HOLE

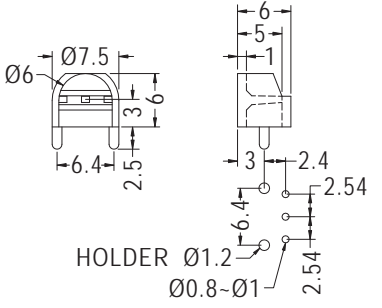

MOUNTING HOLE

Part No.	Package
LEK-501	1000

Part No.	Package
LEK-505	1000

Part No.	Package
LEK-508	1000



- Material: Nylon 66 (UL)
- Flame Class: 94V-2/94V-0
- Color: Black
- Unit: mm

用途：使 $\varnothing 5$ mm LED成90°焊於PC板上，高度一致，有定位腳，不傾斜。

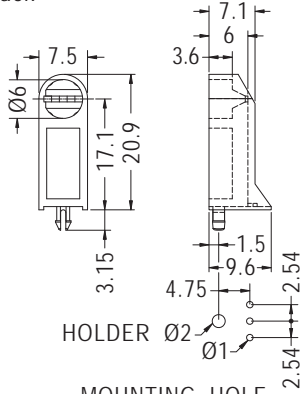

MOUNTING HOLE THICKNESS 1.6

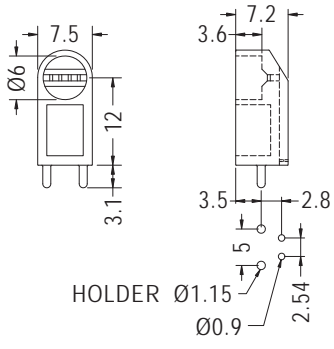

MOUNTING HOLE

- Color: Natural/Black

Part No.	Package
LEK-546	1000

Part No.	Package
LEK-556	1000

90° LED燈座 90° LED HOLDER

用途：使 $\varnothing 5$ mm 3 PIN LED成90°焊於PC板上，高度一致，有定位腳，不傾斜。

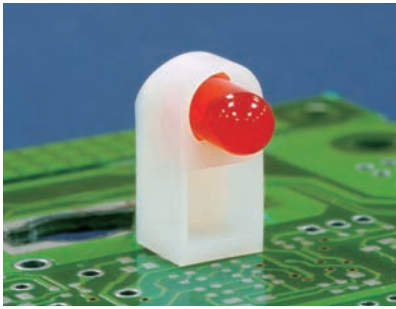

- Material: Nylon 66 (UL)
- Flame Class: 94V-2/94V-0
- Color: Natural/Black
- Unit: mm

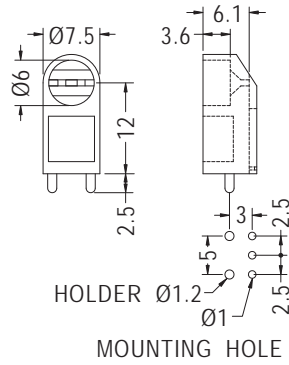

Part No.	Package
LED5L-12	1000

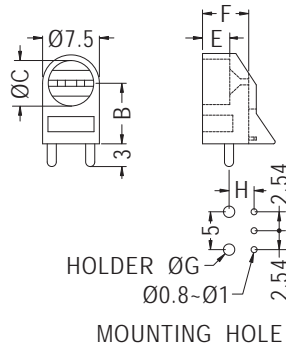
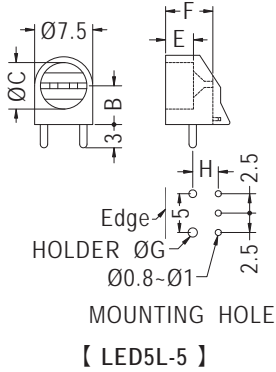

Part No.	B	C	E	F	G	H	Package
LED5L-5	5.0	6.1	3.6	6.0	1.0	3.3	1000
LED5L-8	8.0	6.05	3.7	6.0	1.5	3.3	
LED5L-11	11.0	6.1	3.6	6.1	1.5	3.0	
LED5L-14	14.0	6.05	3.7	6.1	1.5	3.3	
LED5L-17	17.5	6.2	3.6	6.1	1.2	3.0	

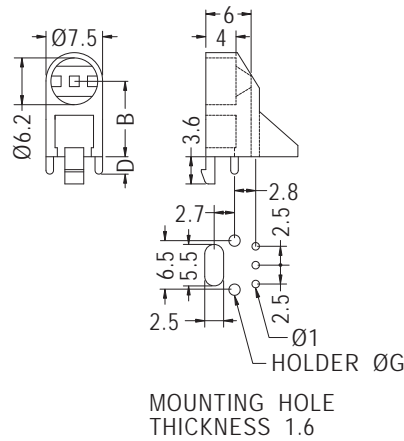

Part No.	B	D	G	Package
LED5L-7	7.0	2.5	1.7	1000
LED5L-10	10.0	2.3	1.5	
LED5L-13	13.5	2.3	1.5	

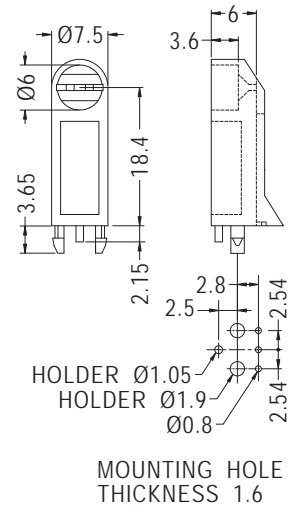

Part No.	Package
LED5L-18	1000



- Material: Nylon 66 (UL)
- Flame Class: 94V-2/94V-0
- Color: Natural/Black
- Unit: mm

用途：使LED成90°焊於PC板上，高度一致，有定位腳，不傾斜。

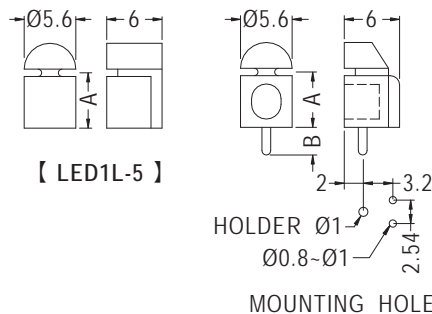

Part No.	A	B	Package
LED1L-5	5.0		2000
LED1L-6	6.0	3.0	
LED1L-7	7.0	3.0	
LED1L-8	8.0	3.0	1000
LED1L-9	9.0	3.0	
LED1L-10	10.0	2.5	

90° LED燈座 90° LED HOLDER

用途：使LED成90°焊於PC板上，高度一致，有定位腳，不傾斜。

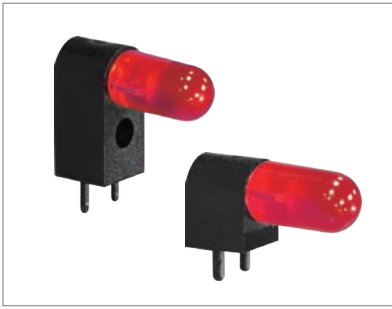

- Material: Nylon 66 (UL)
- Flame Class: 94V-2/94V-0
- Color: Natural/Black
- Unit: mm

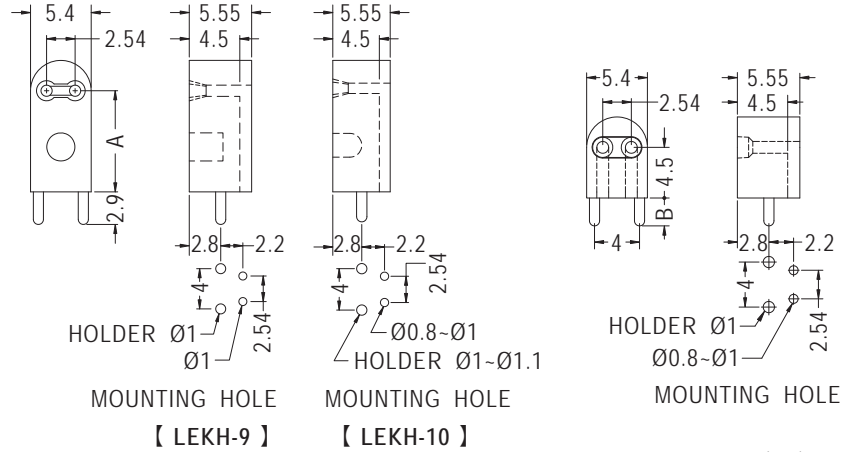
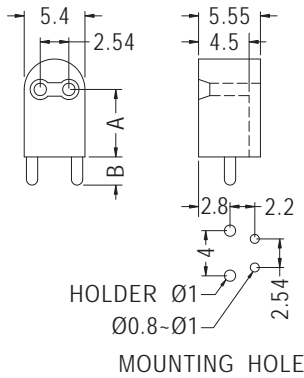

Part No.	A	B	Package
LEKH-3	3.0	2.9	1000
LEKH-6	6.0	2.5	
LEKH-7	7.0	2.5	

Part No.	A	Package
LEKH-9	9.0	1000
LEKH-10	10.0	

Part No.	B	Package
LEKH-4.5	2.5	1000
LEKH-4.5S	1.2	

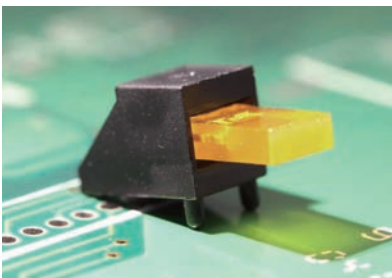

- Material: Nylon 66 (UL)
- Flame Class: 94V-2/94V-0
- Color: Black
- Unit: mm

用途：使方形LED成90°焊於PC板上，高度一致，有定位腳，不傾斜。

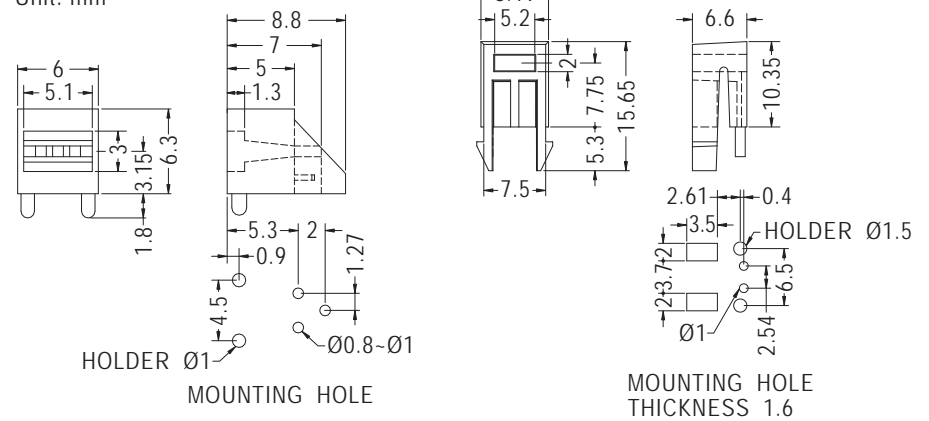
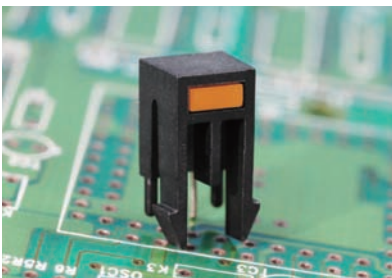

Part No.	Package
LEK-518	1000

Part No.	Package
LEK-520	1000

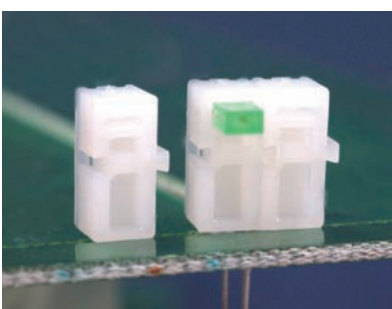

- Material: Nylon 66 (UL)
- Flame Class: 94V-2/94V-0
- Color: Natural/Black
- Unit: mm

用途：使LED成90°焊於PC板上，高度一致，有定位腳，不傾斜，可組合使用。

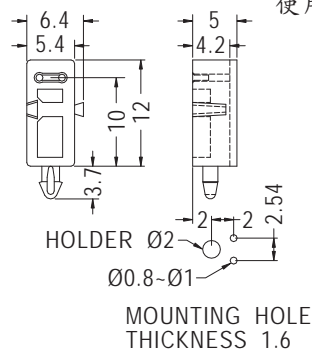

Part No.	Package
LEKH-6301	1000

90° LED燈座 90° LED HOLDER

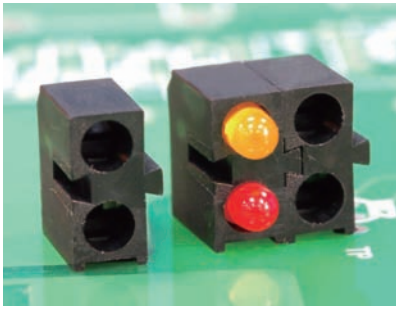

- Material: Nylon 66 (UL)
- Flame Class: 94V-2/94V-0
- Color: Black
- Unit: mm

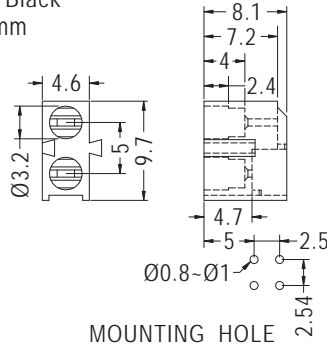

Part No.	Package
LED-6302	2000

用途：使Ø3 mm LED成90°焊於PC板上，高度一致，不斷腳，可組合使用。

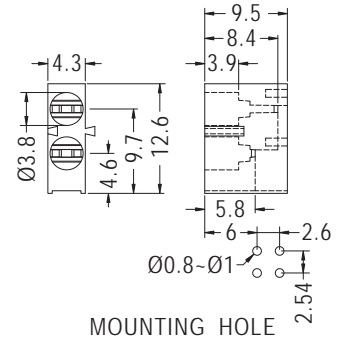

Part No.	Package
LED-6303	2000

3



- Material: Nylon 66 (UL)
- Flame Class: 94V-2/94V-0
- Color: Black
- Unit: mm

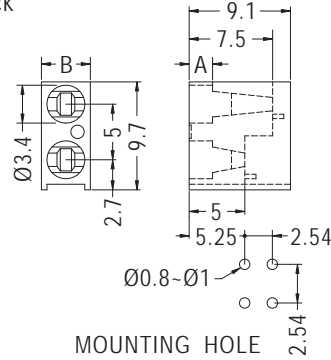

用途：使Ø3 mm LED成90°焊於PC板上，高度一致，不斷腳。

Part No.	A	B	Package
LED-306	2.1	4.4	1000
LED-306(A)	1.5	4.3	

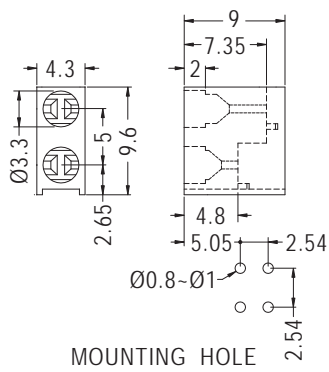

Part No.	Package
LED-306(B)	1000

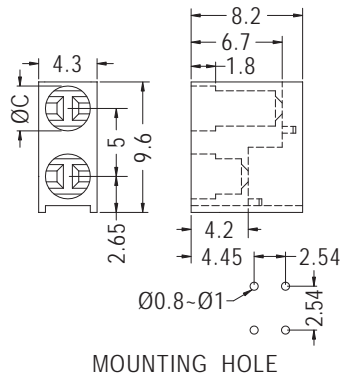

Part No.	C	Package
LED-307	3.3	1000
LED-307(A)	3.2	

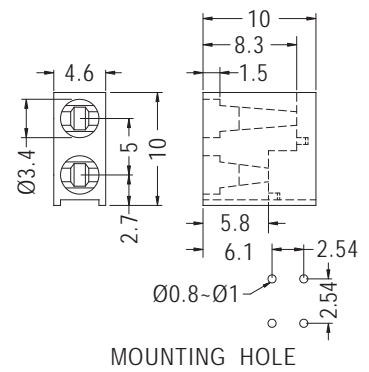

Part No.	Package
LED-308	1000

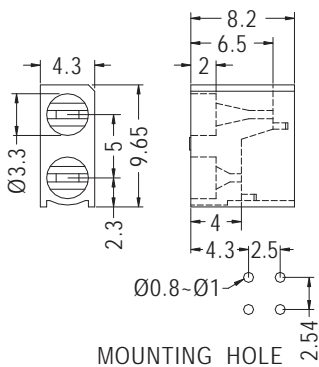

Part No.	Package
LED-322	1000

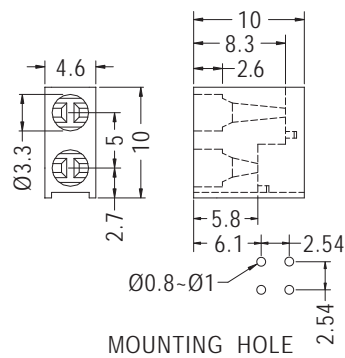

Part No.	Package
LED-324	1000

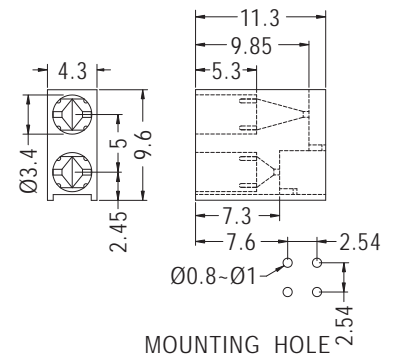

Part No.	Package
LED-323	1000

90° LED燈座 90° LED HOLDER

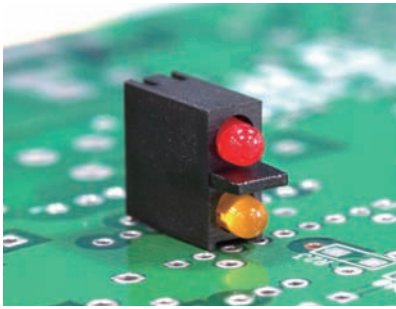

- Material: Nylon 66 (UL)
- Flame Class: 94V-2/94V-0
- Color: Black
- Unit: mm

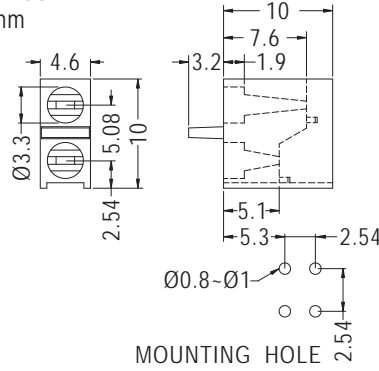

Part No.	Package
LED-305	1000

用途：使Ø3 mm LED成90°焊於PC板上，高度一致，不斷腳。

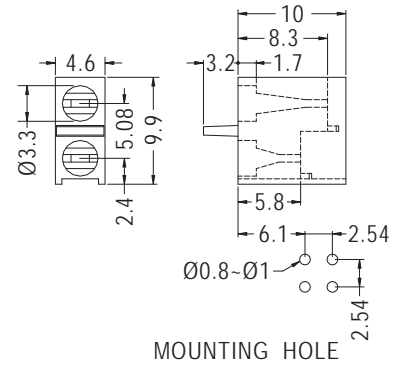

Part No.	Package
LED-317	1000

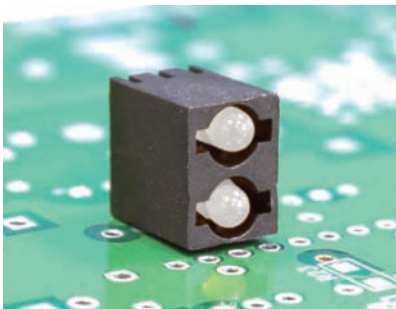

- Material: Nylon 66 (UL)
- Flame Class: 94V-2/94V-0
- Color: Black
- Unit: mm

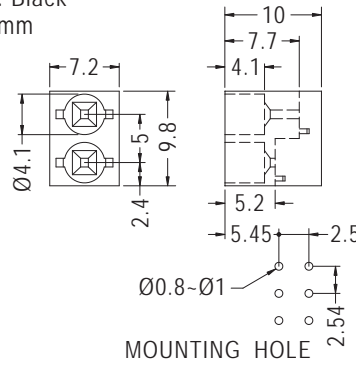

Part No.	Package
LED-310	1000

用途：使Ø3 mm 3 PIN LED成90°焊於PC板上，高度一致，不斷腳。

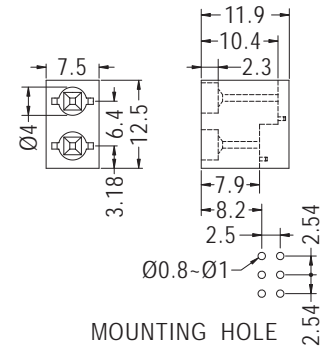

Part No.	Package
LED-342	1000



- Material: Nylon 66 (UL)
- Flame Class: 94V-2/94V-0
- Color: Black
- Unit: mm

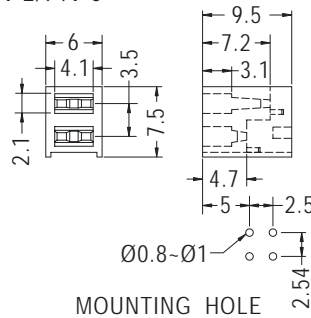

Part No.	Package
LED-521	1000

用途：使方形LED成90°焊於PC板上，高度一致，不斷腳。

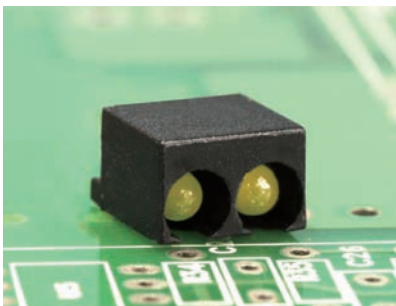

- Material: Nylon 66 (UL)
- Flame Class: 94V-2/94V-0
- Color: Black
- Unit: mm

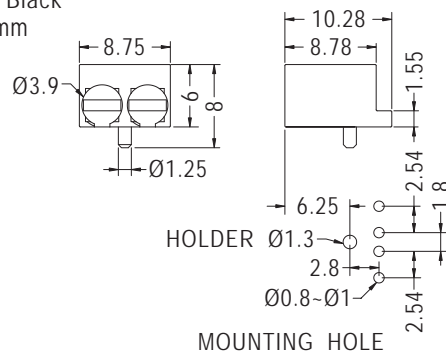

Part No.	Package
LEK-316	2000

用途：使Ø3 mm 3 PIN LED成90°焊於PC板上，高度一致，有定位腳，不傾斜。

90° LED燈座 90° LED HOLDER

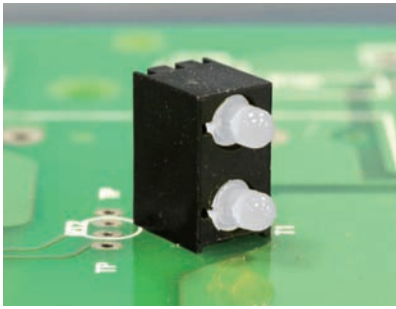

- Material: Nylon 66 (UL)
- Flame Class: 94V-2/94V-0
- Color: Black
- Unit: mm

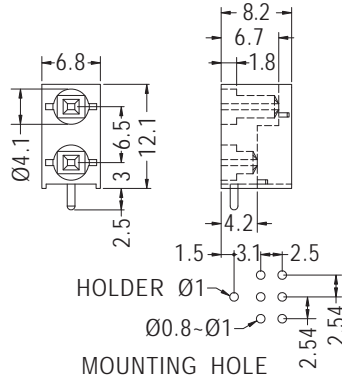

Part No.	Package
LEK-327	1000

用途：使 $\varnothing 3$ mm 3 PIN LED成90°焊於PC板上，高度一致，有定位腳，不傾斜。

3

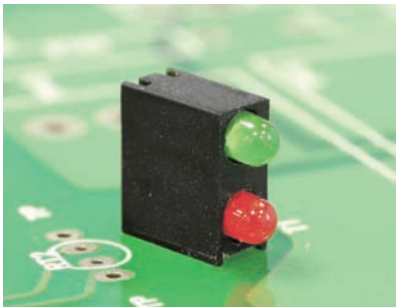

- Material: Nylon 66 (UL)
- Flame Class: 94V-2/94V-0
- Color: Black
- Unit: mm

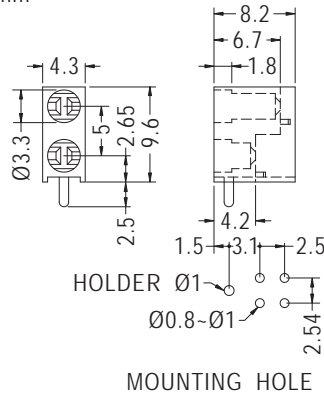

Part No.	Package
LEK-307	1000

用途：使 $\varnothing 3$ mm LED成90°焊於PC板上，高度一致，有定位腳，不斷腳。

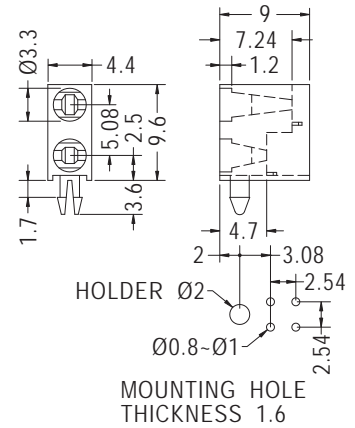

Part No.	Package
LEK-320	1000

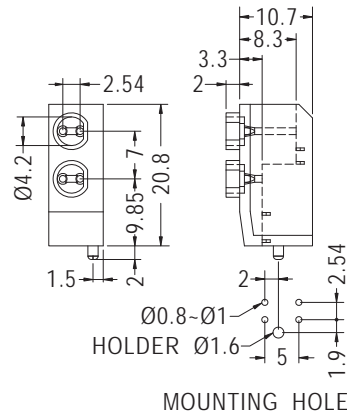

Part No.	Package
LEK-323	1000

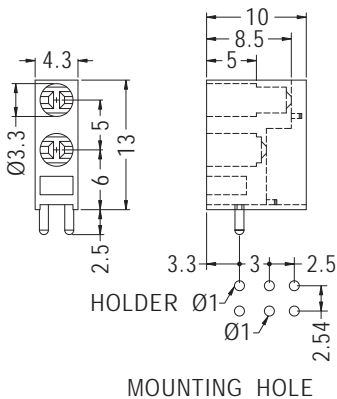

Part No.	Package
LEK-325	1000

MOUNTING HOLE

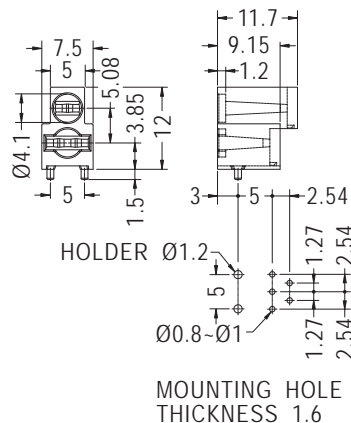

Part No.	Package
LEK-345	2000

MOUNTING HOLE THICKNESS 1.6

90° LED燈座 90° LED HOLDER



- Material: Nylon 66 (UL)
- Flame Class: 94V-2/94V-0
- Color: Black
- Unit: mm

用途：使 $\varnothing 5$ mm LED成90°焊於PC板上，高度一致，不斷腳。

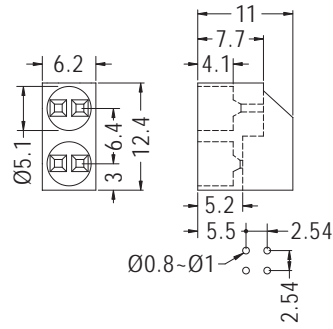

Part No.	Package
LED-525	1000

MOUNTING HOLE



- Material: Nylon 66 (UL)
- Flame Class: 94V-2/94V-0
- Color: Black
- Unit: mm

用途：使 $\varnothing 5$ mm LED成90°焊於PC板上，高度一致，有定位腳，不傾斜。

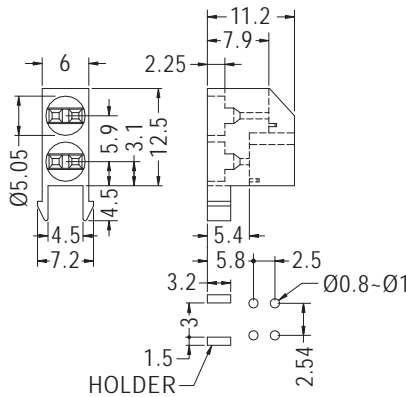

MOUNTING HOLE THICKNESS 1.6

Part No.	Package
LEK-512	1000

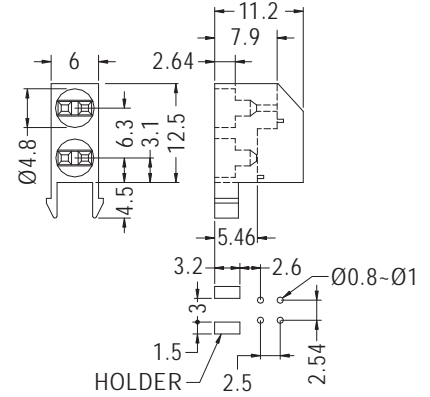

MOUNTING HOLE THICKNESS 1.6

Part No.	Package
LEK-515	1000



- Material: Nylon 66 (UL)
- Flame Class: 94V-2/94V-0
- Color: Black
- Unit: mm

用途：使 $\varnothing 3$ mm LED成90°焊於PC板上，高度一致，不斷腳。

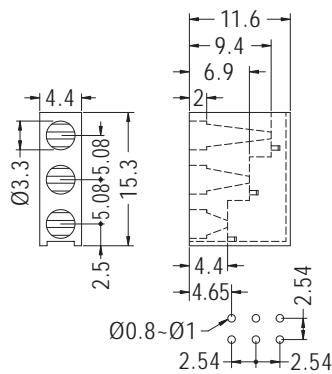

MOUNTING HOLE

Part No.	Package
LED-330	1000

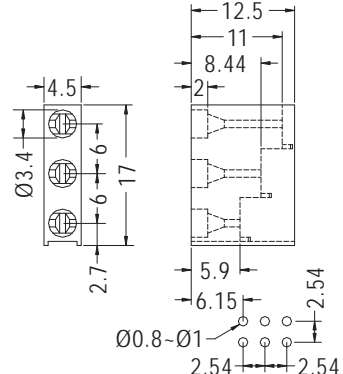

MOUNTING HOLE

Part No.	Package
LED-331	1000

90° LED燈座 90° LED HOLDER

用途：使Ø3 mm LED成90°焊於PC板上，高度一致，組合式字母套，焊腳不搖動。



- Material: Nylon 66 (UL)
- Flame Class: 94V-2/94V-0
- Color: Black
- Unit: mm

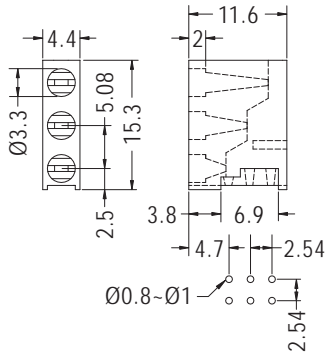

MOUNTING HOLE

Part No.	Package
LH-330	1000

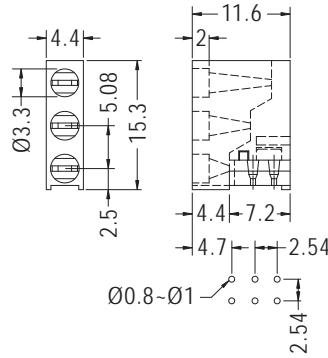

MOUNTING HOLE

Part No.	Package
KLH-330	1000

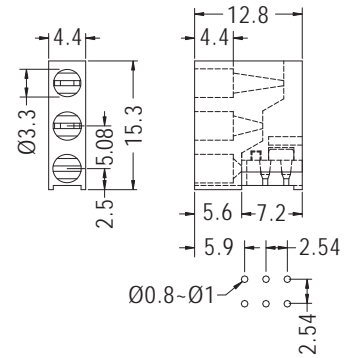

MOUNTING HOLE

Part No.	Package
KLH-331	1000

3

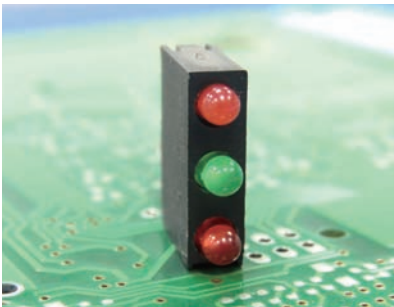

- Material: Nylon 66 (UL)
- Flame Class: 94V-2/94V-0
- Color: Black
- Unit: mm

用途：使Ø3 mm LED成90°焊於PC板上，高度一致，有定位腳，不傾斜。

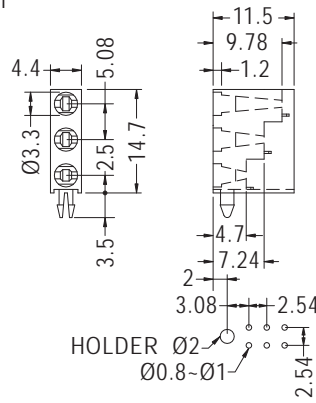

MOUNTING HOLE THICKNESS 1.6

Part No.	Package
LEK-330	1000

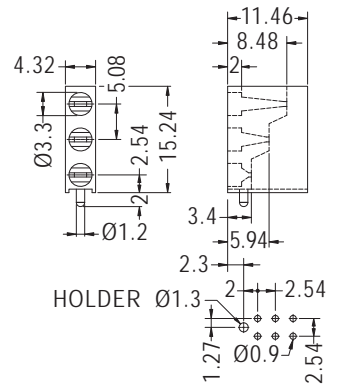

MOUNTING HOLE

Part No.	Package
LEK-331	1000

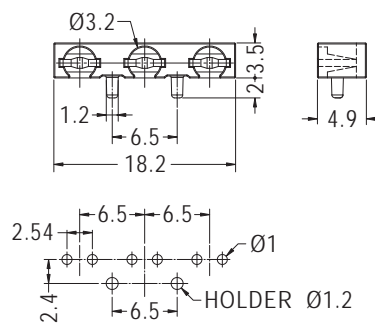
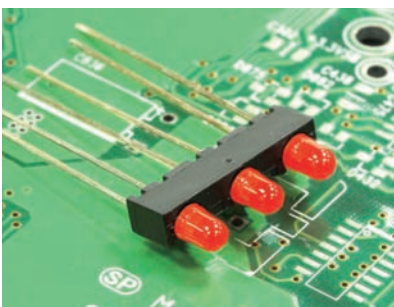

MOUNTING HOLE

Part No.	Package
LEK-348	1000

90° LED燈座 90° LED HOLDER

用途：使方形LED成90°焊於PC板上，高度一致，有定位腳，不傾斜。

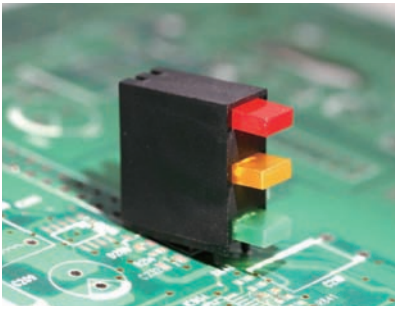

- Material: Nylon 66 (UL)
- Flame Class: 94V-2/94V-0
- Color: Black
- Unit: mm

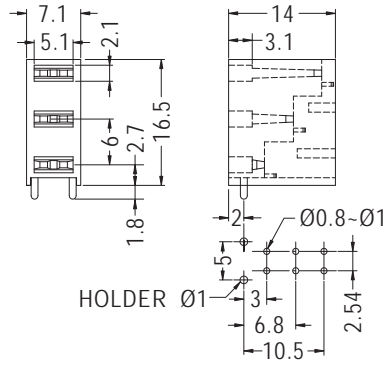

Part No.	Package
LEK-315	1000

MOUNTING HOLE

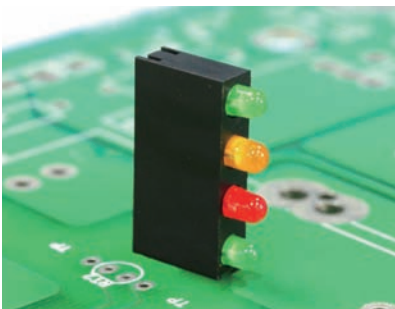

- Material: Nylon 66 (UL)
- Flame Class: 94V-2/94V-0
- Color: Black
- Unit: mm

用途：使Ø3 mm LED成90°焊於PC板上，高度一致，不斷腳。

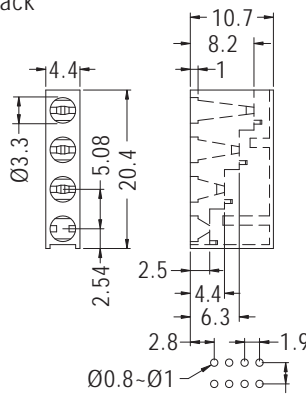

MOUNTING HOLE

Part No.	Package
LED-340	1000

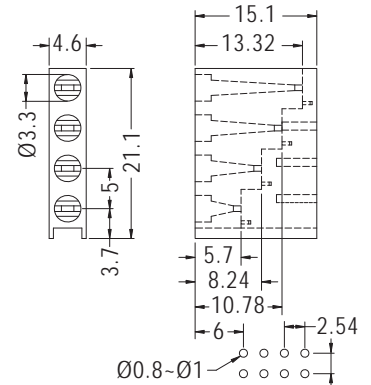

MOUNTING HOLE

Part No.	Package
LED-345	1000



- Material: Nylon 66 (UL)
- Flame Class: 94V-2/94V-0
- Color: Black
- Unit: mm

用途：使Ø3 mm LED成90°焊於PC板上，高度一致，組合式子母套，焊腳不搖動。

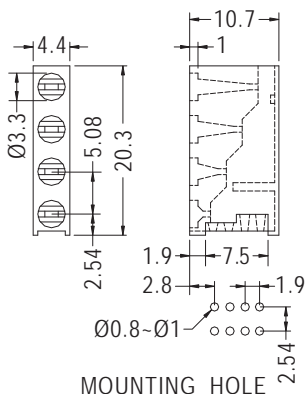

MOUNTING HOLE

Part No.	Package
LH-340	1000

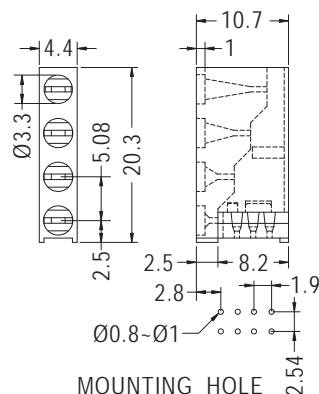

MOUNTING HOLE

Part No.	Package
KLH-340	1000

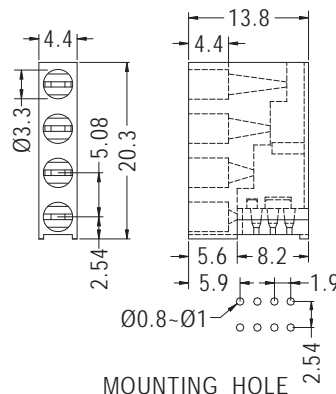

MOUNTING HOLE

Part No.	Package
KLH-341	1000

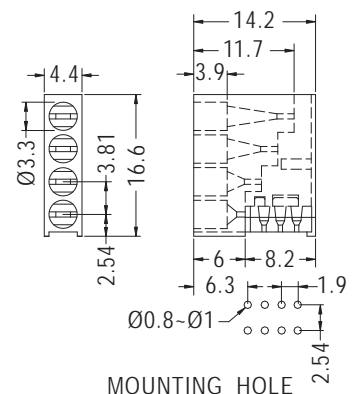

MOUNTING HOLE

Part No.	Package
KLH-342	1000

90° LED燈座 90° LED HOLDER

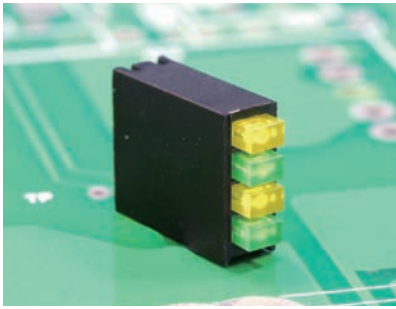

- Material: Nylon 66 (UL)
- Flame Class: 94V-2/94V-0
- Color: Black
- Unit: mm

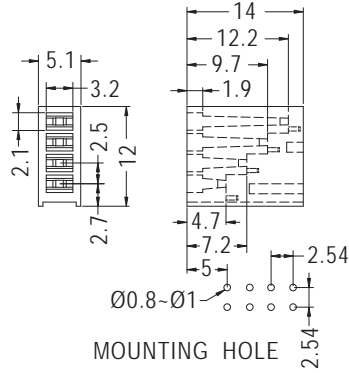

Part No.	Package
LED-341	1000

用途：使方形LED成90°焊於PC板上，高度一致，不斷腳。

3



- Material: Nylon 66 (UL)
- Flame Class: 94V-2/94V-0
- Color: Black
- Unit: mm

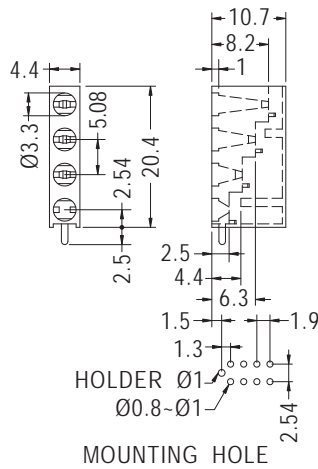

Part No.	Package
LEK-340	1000

用途：使 $\varnothing 3$ mm LED成90°焊於PC板上，高度一致，有定位腳，不傾斜。

LED燈座 LED MOUNT



- Material: Silicon Rubber
- Color: Black
- Unit: mm

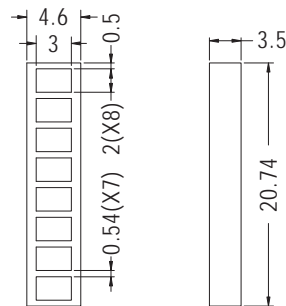

Part No.	Package
TF-1298	1000

用途：用於LED座。



- Material: Nylon 66 (UL)
- Flame Class: 94V-2/94V-0
- Color: Black
- Unit: mm

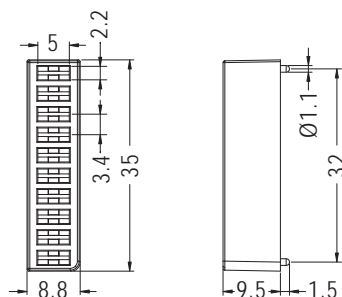

Part No.	Package
LED101	500

用途：使方形5X2 LED 10顆預先組合，可快速固定於PC板上。

4



- 排線固定板/固定扣/線夾
Cable Clamps & Clips
- 電線固定座
Wire Saddles
- 隔離束線座
Standoff Cable Clip
- 扭式固定座/環
Twist Locks
- 束線帶固定座
Cable Tie Mounts
- 軌道式線扣組
Cable Carriers
- 電源線/插座固定座
Power Cord/
Socket Fasteners
- 其它固定產品
Other Mounts &
Fasteners



排線固定板 FLAT CABLE CLAMP

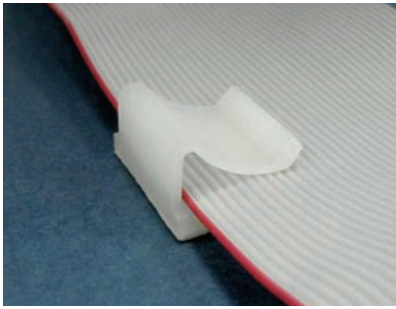

- Material: Nylon 66 (UL)
- Flame Class: 94V-2/94V-0
- Color: Natural/Black
- Unit: mm

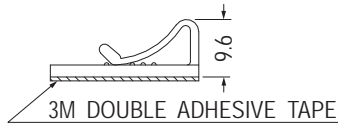
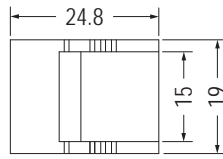

Part No.	Package
FC-19	500

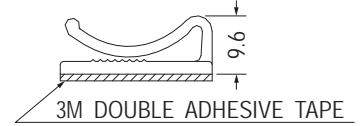
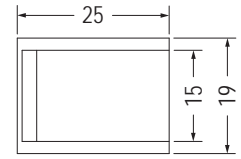

Part No.	Package
FC-19L	500

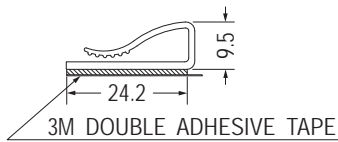
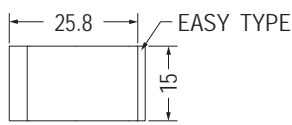

Part No.	Package
★FCF-15	500

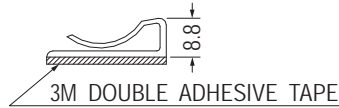
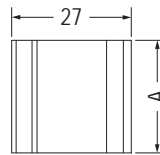

Part No.	A	Package
FCN-15	15.0	500
FCN-20	20.0	
FCN-25	25.4	

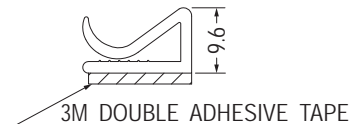
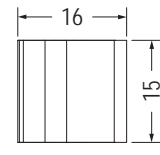

Part No.	Package
FCN-16	500



- Material: PVC
- Color: Gray
- Unit: mm

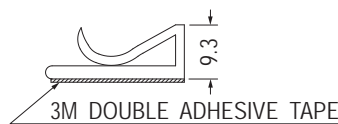
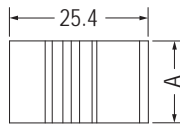

Part No.	A	Package
FCC-15	15.0	500
FCC-20	20.0	
FCC-25	25.0	250

電線固定座 FLAT CABLE CLAMP

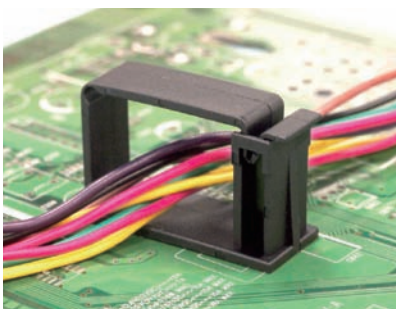

- Material: Nylon 66 (UL)
- Flame Class: 94V-2/94V-0
- Color: Natural/Black
- Unit: mm

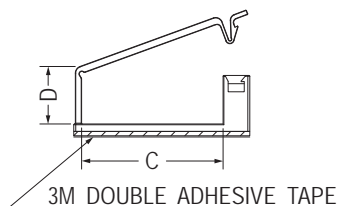
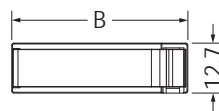

Part No.	B	C	D	Package
FCA-20	44.8	36.0	14.6	200
FCA-21	61.0	52.2	10.7	

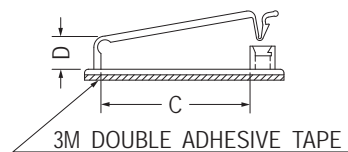
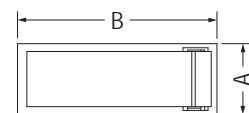

Part No.	A	B	C	D	Package
FCA-1	19.7	77.6	64.0	9.95	50
FCA-2	19.0	53.5	40.0	8.9	100
FCA-3	19.0	45.8	32.0	8.44	200
FCA-24	16.0	50.0	37.6	15.2	

用途：背膠式，用於電子、電腦內部電線固定，裝配容易，美觀不脫落。

電線固定座 FLAT CABLE CLAMP

用途：背膠式，用於電子、電腦內部電線固定，裝配容易，美觀不脫落。

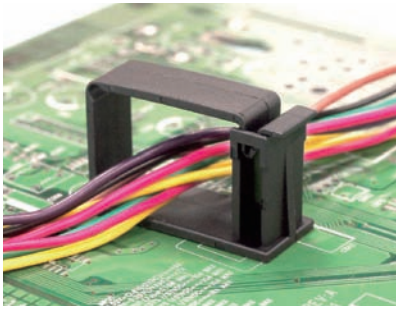

- Material: Nylon 66 (UL)
- Flame Class: 94V-2/94V-0
- Color: Natural/Black
- Unit: mm

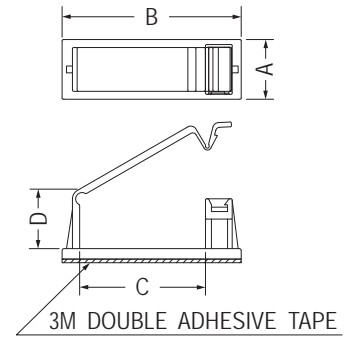
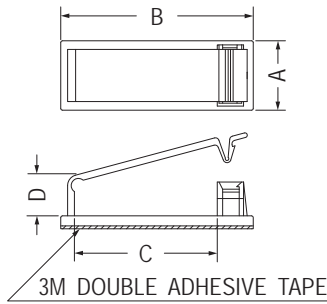

Part No.	A	B	C	D	Package
FCA-5	19.8	45.4	31.8	15.2	200
FCA-6	19.3	53.5	39.7	12.0	
FCA-7	19.3	53.5	39.7	11.7	
FCA-8	19.2	53.5	39.7	9.5	
FCA-19	18.7	55.2	41.3	7.0	

Part No.	A	B	C	D	Package
FCA-9	15.0	45.0	31.6	14.95	200
FCA-10	19.0	78.2	64.6	14.8	100
FCA-11	15.0	38.5	27.0	11.6	200
FCA-14	19.8	66.5	52.6	12.1	
FCA-17	14.8	38.0	26.9	24.1	
FCA-18	14.8	38.0	26.9	30.1	

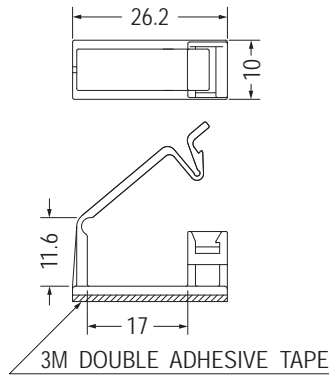
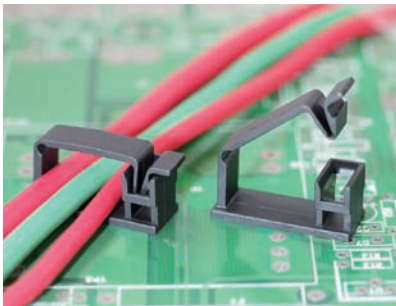

NEW

Part No.	Package
FCA-25	200

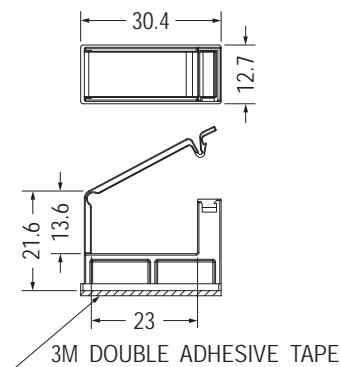

Part No.	Package
FCAC-1	1000

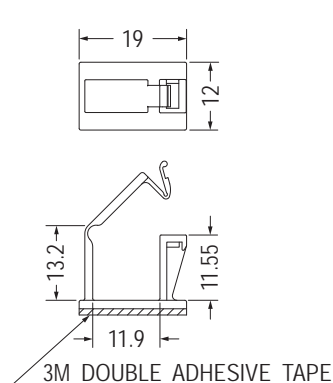
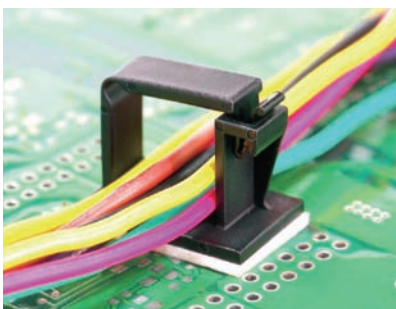

Part No.	Package
FCAB-1	500

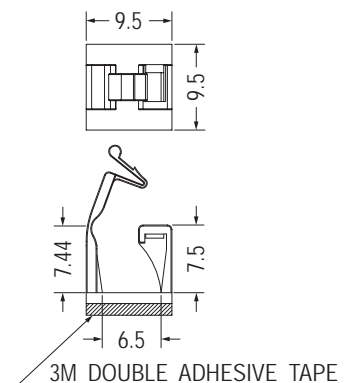

Part No.	Package
FCAB-7	1000

電線固定座 FLAT CABLE CLAMP

用途：背膠式，用於電子、電腦內部電線固定，裝配容易，美觀不脫落。

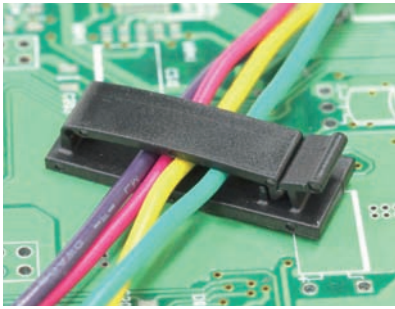

- Material: Nylon 66 (UL)
- Flame Class: 94V-2/94V-0
- Color: Natural/Black
- Unit: mm

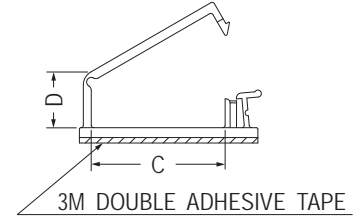
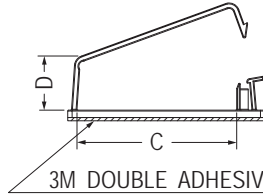
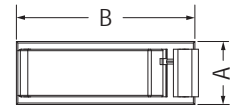
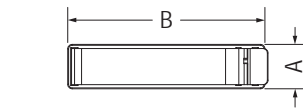

【 FCU-14 】

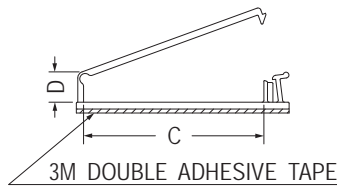
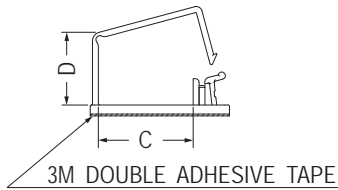
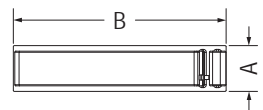
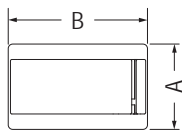

【 FCU-9 】

【 FCU-13 】

Part No.	A	B	C	D	Package
FCU-1	12.7	40.7	31.5	5.5	200
FCU-2	12.7	36.0	27.0	11.2	
FCU-3	15.0	36.0	27.0	13.9	
FCU-4	12.5	35.8	26.8	8.3	
FCU-5	12.7	26.2	17.0	4.55	
FCU-7	10.0	28.0	19.0	3.4	100
FCU-8	12.9	72.3	63.1	6.7	
FCU-9	18.8	30.7	20.9	16.0	
FCU-12	10.0	26.2	17.0	11.6	
FCU-13	12.7	59.0	50.0	8.4	
FCU-14	15.0	66.7	54.0	20.0	200
FCU-15	12.7	41.0	32.0	12.4	

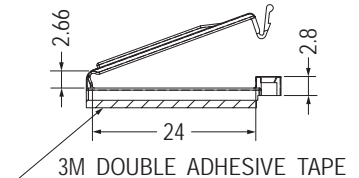
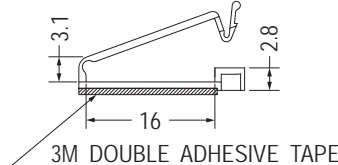
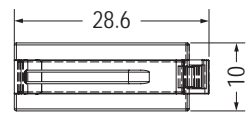
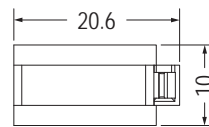

Part No.	Package
FCAB-2	500

Part No.	Package
FCAB-3	500

排線固定座 FLAT CABLE CLAMP

用途：背膠式，用於電子、電腦內部排線固定，裝配容易，美觀不脫落。

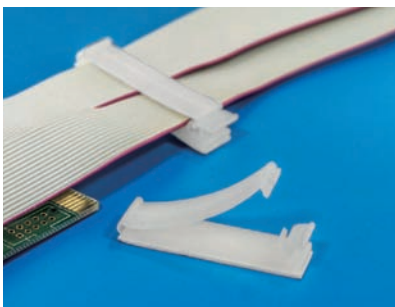

- Material: Nylon 66 (UL)
- Flame Class: 94V-2/94V-0
- Color: Natural/Black
- Unit: mm

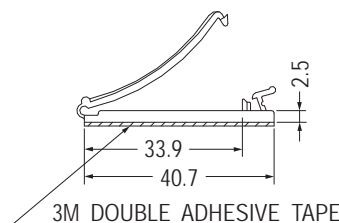
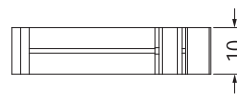

Part No.	Package
FCJ-40	100

電線固定座 CABLE CLAMP

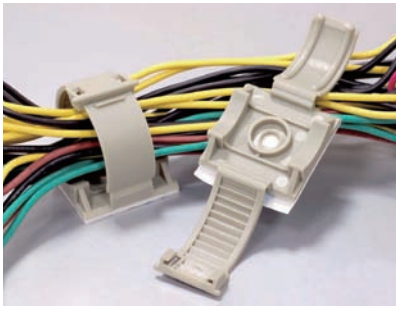

- Material: Nylon 66 (UL)
- Flame Class: 94V-2/94V-0
- Color: Natural/Black/Gray
- Unit: mm

用途：背膠式，用於電子、電腦內部電線固定，裝配容易，美觀不脫落。

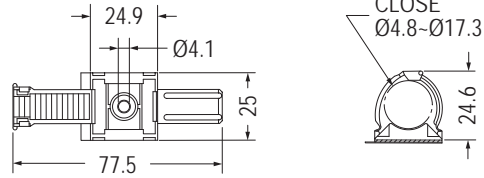

Part No.	Package
CWK-1	200

排線固定座 FLAT CABLE CLAMP



- Material: Nylon 66 (UL)
- Flame Class: 94V-2/94V-0
- Color: Natural/Black/Gray
- Unit: mm

用途：背膠式，用於電子、電腦內部排線固定，裝配容易，美觀不脫落。

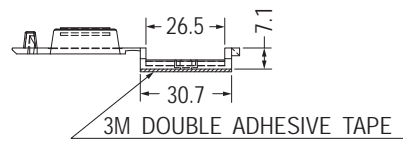
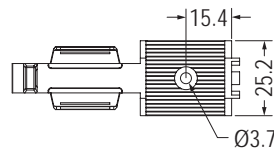

Part No.	Package
FCH-29	100

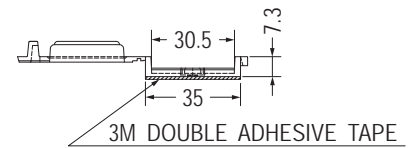
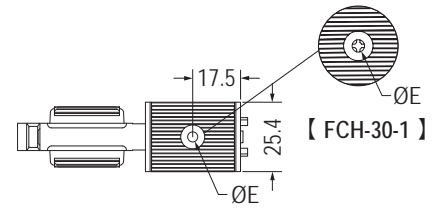

Part No.	E	Package
FCH-30	3.7	100
FCH-30-1	4.5	

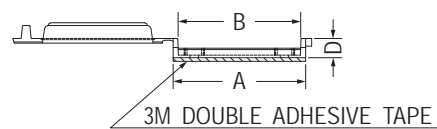
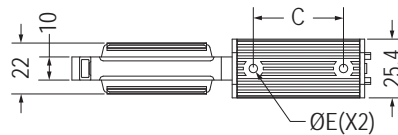
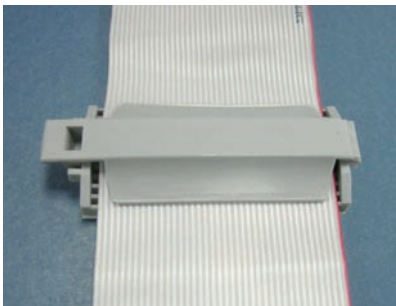

Part No.	A	B	C	D	E	Package
FCH-50	57.3	53.0	39.0	8.3	3.7	50
FCH-80	82.3	78.93	38.7	12.3	3.8	

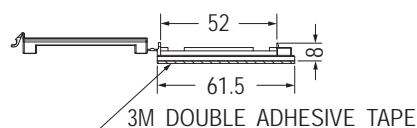
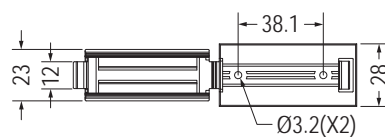

Part No.	Package
FCHA-1	50

排線固定座 FLAT CABLE CLAMP

用途：背膠式，用於電子、電腦內部排線固定，裝配容易，美觀不脫落。

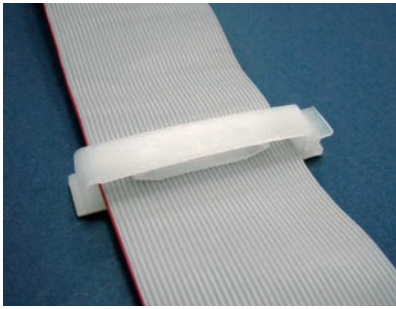

- Material: Nylon 66 (UL)
- Flame Class: 94V-2/94V-0
- Color: Natural/Black
- Unit: mm

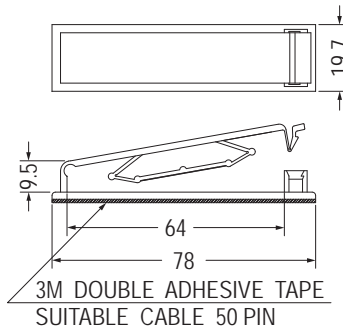

Part No.	Package
FCB-1	100

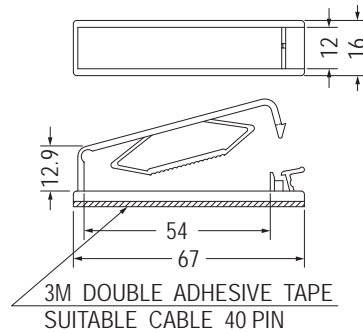
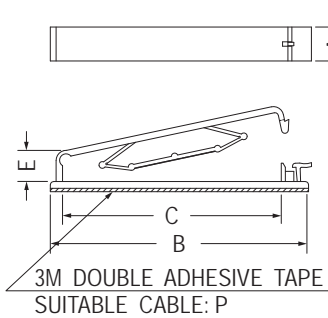

【FCB-40M】
沒有檔板
No Stopper

Part No.	A	B	C	E	P	Package
FCB-40	10.2	65.0	53.8	8.23	40 PIN	200
FCB-50	10.0	77.0	64.5	9.2	50 PIN	100

Part No.	Package
FCB-40M	100
FCB-40MT	

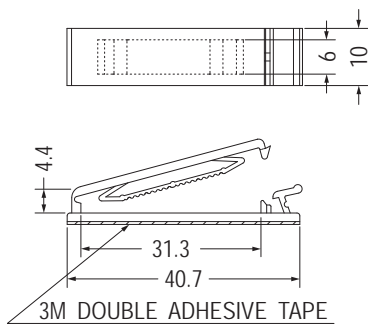

Part No.	Package
FCI-1	200

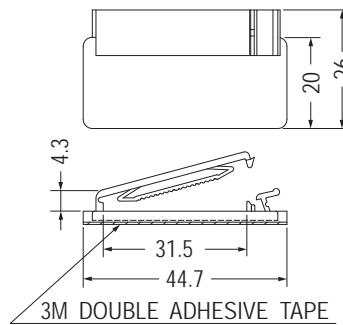

Part No.	Package
FCI-2	100

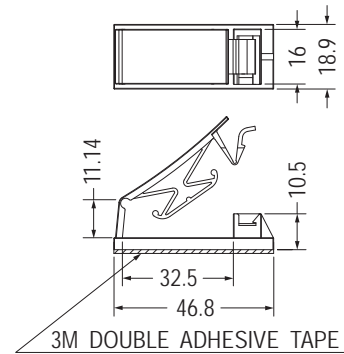

Part No.	Package
FCAM-1	100

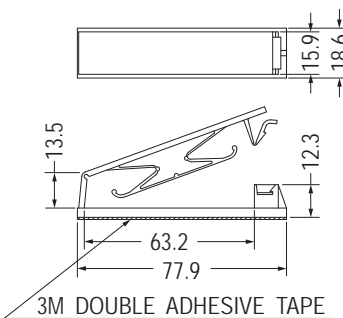

Part No.	Package
FCK-50	100

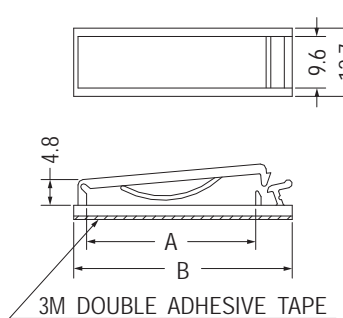

Part No.	A	B	Package
FCE-1	31.5	40.7	200
FCE-2	52.0	61.2	100

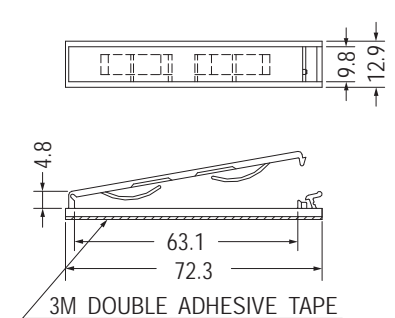

Part No.	Package
FCE-3	100

排線固定座 FLAT CABLE CLAMP

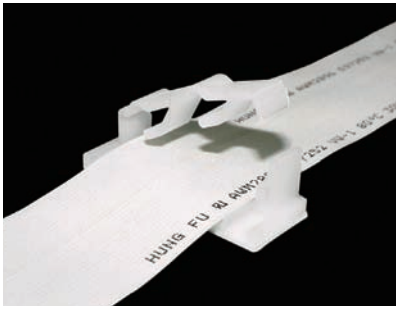

- Material: Nylon 66 (UL)
- Flame Class: 94V-2/94V-0
- Color: Natural/Black
- Unit: mm

用途：可背膠或螺絲固定，用於電子、電腦內部排線固定，裝配容易，美觀不脫落。

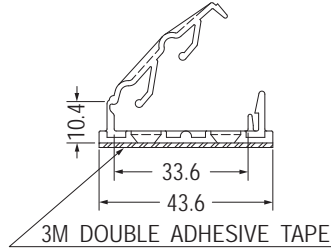
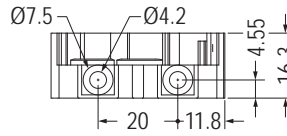

Part No.	Package
FCL-33	200

電線固定座 FLAT CABLE CLAMP

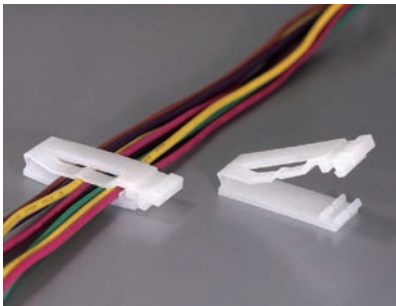

- Material: Nylon 66 (UL)
- Flame Class: 94V-2/94V-0
- Color: Natural/Black
- Unit: mm

用途：背膠式，用於電子、電腦內部電線固定，裝配容易，美觀不脫落。

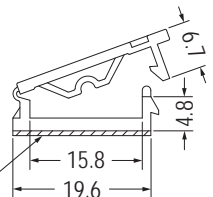
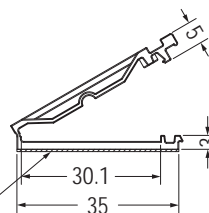
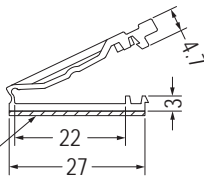
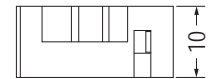
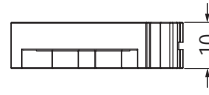
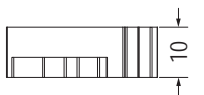

Part No.	Package
★FCS-2	200

Part No.	Package
FCS-20	200

Part No.	Package
FCS-15	500

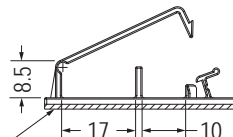
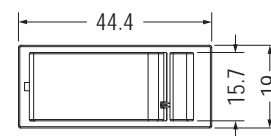

3M DOUBLE ADHESIVE TAPE

Part No.	Package
FCUB-1	200

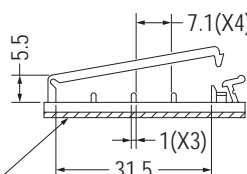
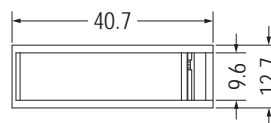

3M DOUBLE ADHESIVE TAPE

Part No.	Package
FCUB-2	200

排線固定夾 FLAT CABLE CLAMP

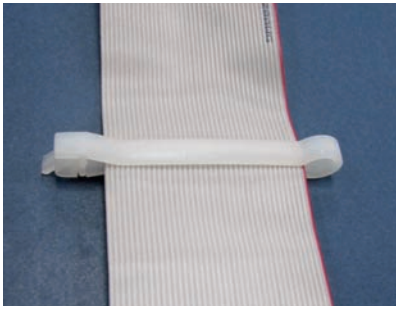

- Material: Nylon 66 (UL)
- Flame Class: 94V-2/94V-0
- Color: Natural/Black
- Unit: mm

用途：用於電子、電腦內部排線固定，裝配容易，美觀不脫落。

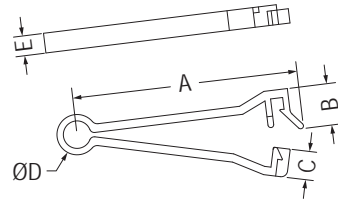

SUITABLE CABLE: P

Part No.	A	B	C	D	E	P	Package
FCE-30	62.3	13.0	8.9	12.0	6.4	30 PIN	100
FCE-40	70.2	12.2	8.7	12.8	6.2	40 PIN	

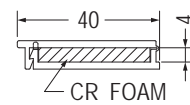
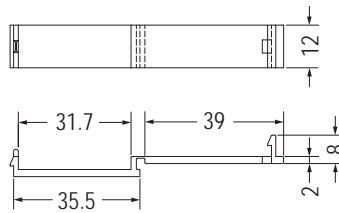

Part No.	Package
FCS-31	100

4

電線固定座 FLAT CABLE CLAMP



- Material: Nylon 66 (UL)
- Flame Class: 94V-2/94V-0
- Color: Natural/Black
- Unit: mm

用途：配合螺絲，固定電線，美觀不脫落。

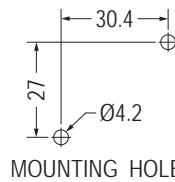
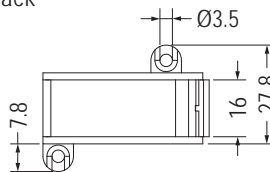

MOUNTING HOLE

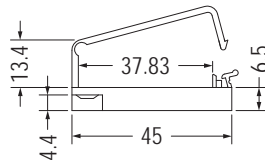

Part No.	Package
FCUA-1	200

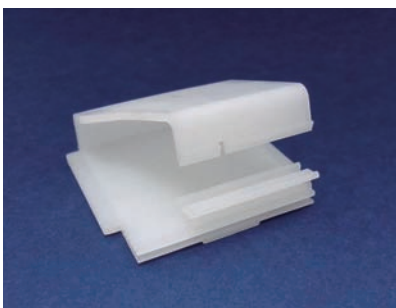

- Material: Nylon 66 (UL)
- Flame Class: 94V-2/94V-0
- Color: Natural/Black
- Unit: mm

用途：用於電線之固定。

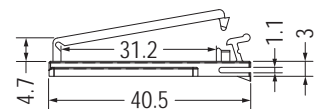
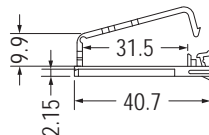
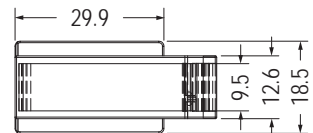
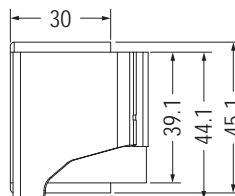

Part No.	Package
FCUA-2	200

Part No.	Package
FCUA-4	200

電線固定座 FLAT CABLE CLAMP

用途：用於電子、電腦內部電線固定，
裝配容易，美觀不脫落。

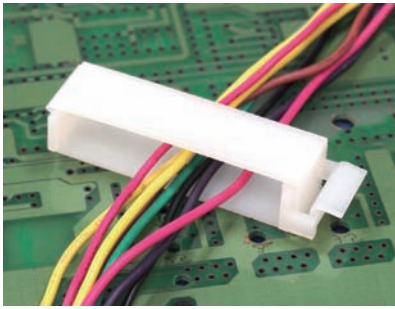

- Material: Nylon 66 (UL)
- Flame Class: 94V-2/94V-0
- Color: Natural/Black
- Unit: mm

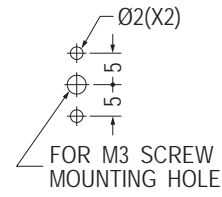
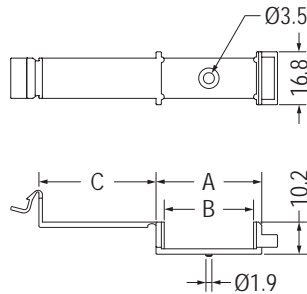

Part No.	A	B	C	Package
FCSA-2	33.6	28.4	37.2	100
FCSA-3	47.8	42.6	51.4	

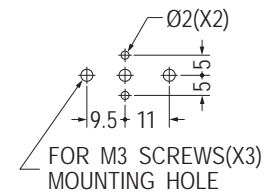
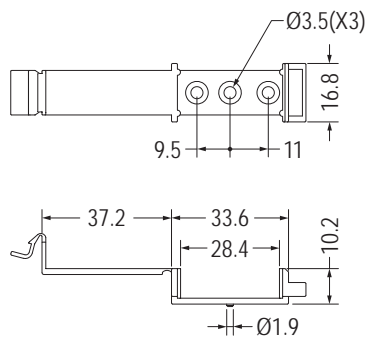
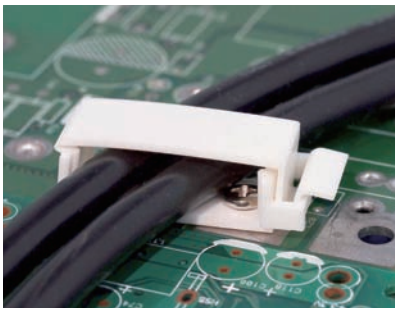

Part No.	Package
FCSA-6	100

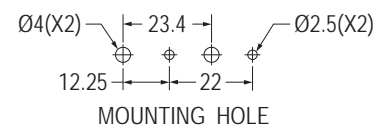
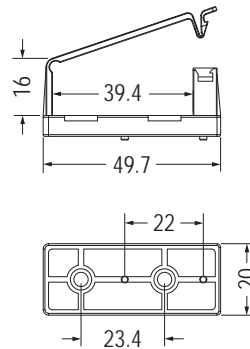

Part No.	Package
FCSA-7	100

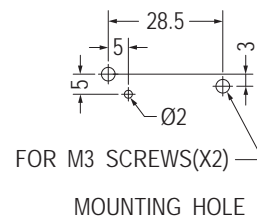
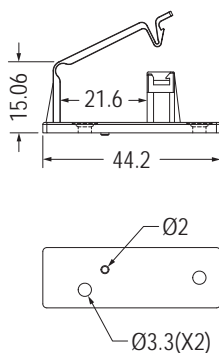
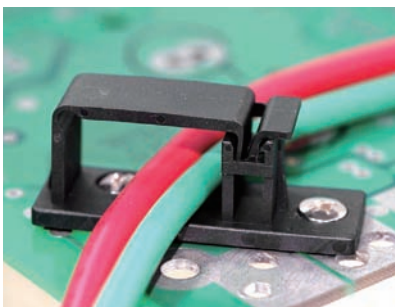

Part No.	Package
FCSA-10	250

電線固定座 FLAT CABLE CLAMP

用途：背膠式，用於電子、電腦內部電線固定，裝配容易，美觀不脫落。

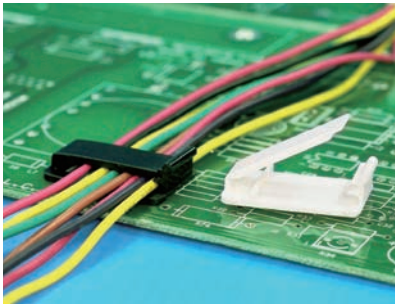

- Material: Nylon 66 (UL)
- Flame Class: 94V-2/94V-0
- Color: Natural/Black
- Unit: mm

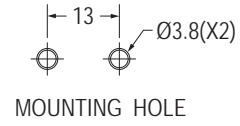
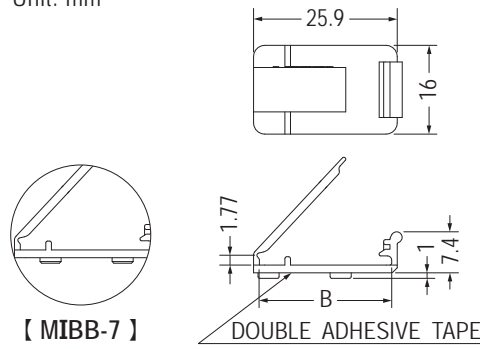

Part No.	B	Package
MIBB-6	23.9	1000
MIBB-7	23.85	

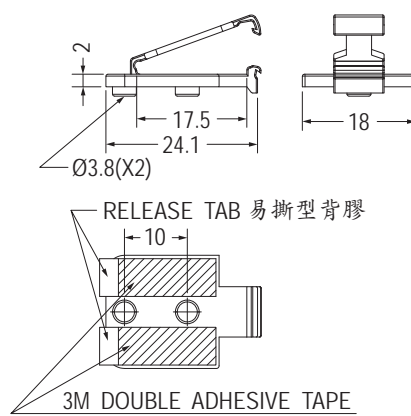

Part No.	Package
MIBD-3	1000

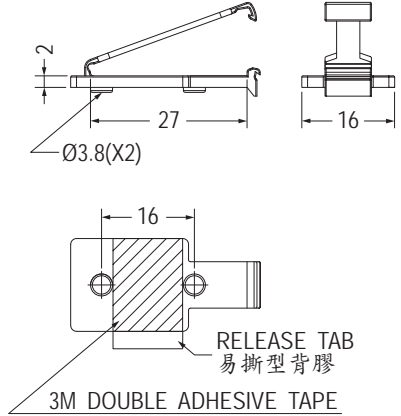

Part No.	Package
MIBB-9	1000



- Material: Nylon 66 (UL)
- Flame Class: 94V-2/94V-0
- Color: Natural/Black
- Unit: mm

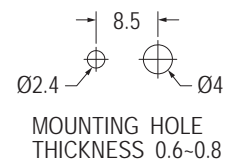
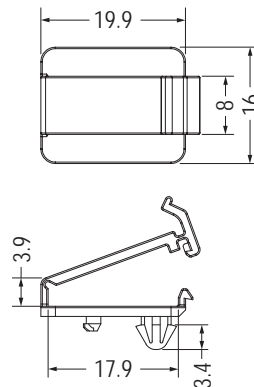

Part No.	Package
MIB-32	1000

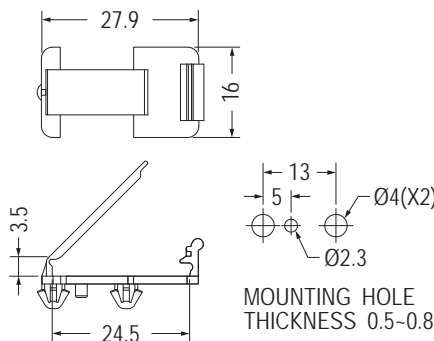
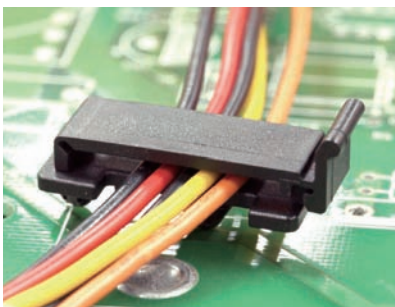

Part No.	Package
MIBB-1	1000

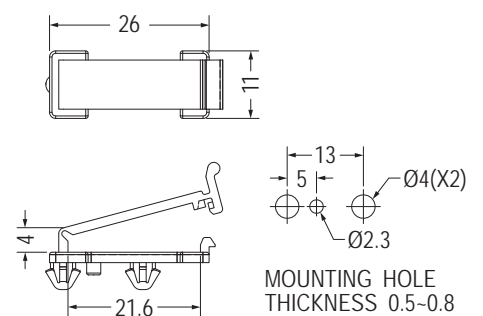

Part No.	Package
MIBB-2	1000

電線固定座 FLAT CABLE CLAMP

用途：用於電子、電腦內部電線固定，
裝配容易，美觀不脫落。

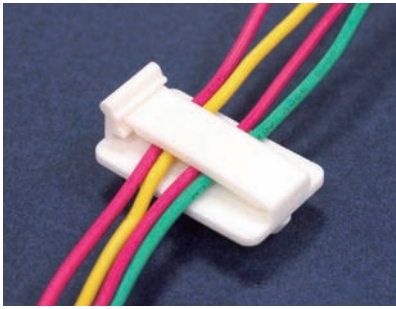

- Material: Nylon 66 (UL)
- Flame Class: 94V-2/94V-0
- Color: Natural/Black
- Unit: mm

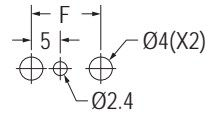
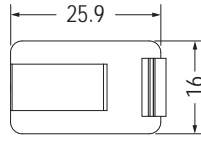

MOUNTING HOLE
THICKNESS 1.0

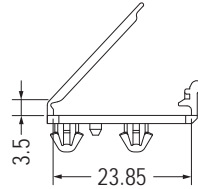

Part No.	F	Package
MIBB-3	12.0	1000
MIBB-5	13.0	

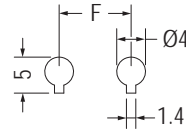
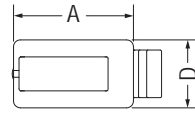
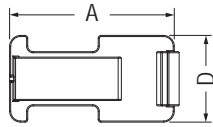

MOUNTING HOLE
THICKNESS 0.5-0.8

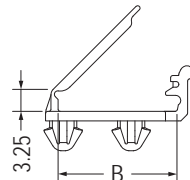
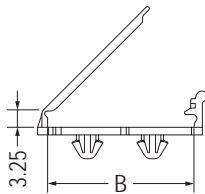

【 MIBB-13 】

Part No.	A	B	D	F	Package
MIBB-11	17.65	17.5	10.0	10.0	1000
MIBB-12	21.15	21.0	10.0	12.0	
MIBB-13	30.4	27.0	16.0	12.0	

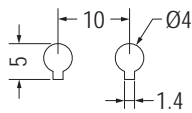
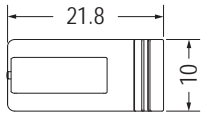

MOUNTING HOLE
THICKNESS 1.5

Part No.	Package
MIBB-16	1000

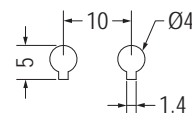
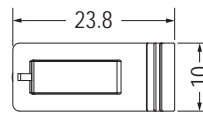
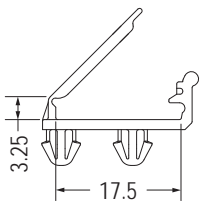

MOUNTING HOLE
THICKNESS: T

Part No.	T	Package
MIBB-19	1.5	1000
★MIBB-19S	1.0-1.2	

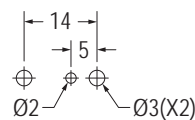
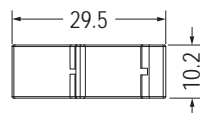
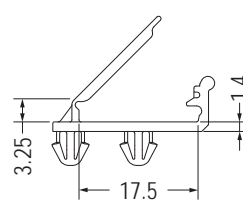

MOUNTING HOLE
THICKNESS 1.0

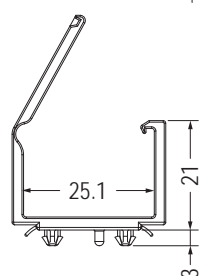

Part No.	Package
MIBA-4	500

電線固定座 FLAT CABLE CLAMP

用途：用於電子、電腦內部電線固定，
裝配容易，美觀不脫落。

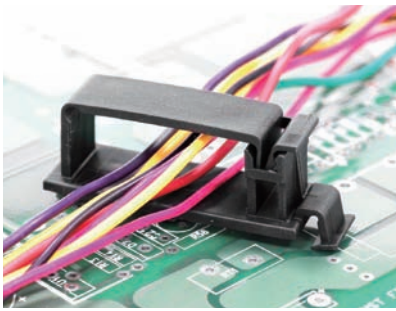

- Material: Nylon 66 (UL)
- Flame Class: 94V-2/94V-0
- Color: Natural/Black
- Unit: mm

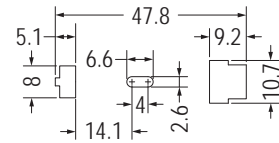
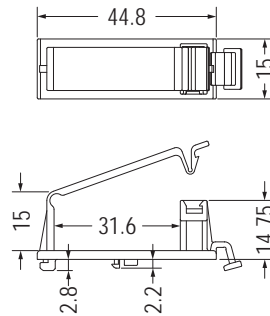

MOUNTING HOLE
CHASSIS THICKNESS 0.8

Part No.	Package
CHWC-1	500

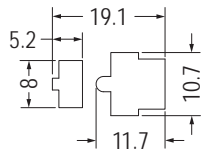
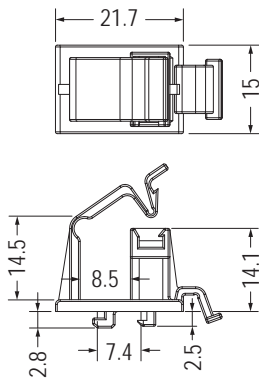

MOUNTING HOLE
THICKNESS 1.0

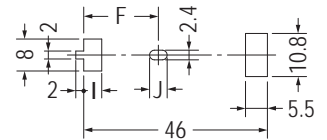
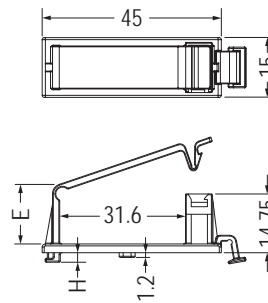

MOUNTING HOLE
THICKNESS: T

Part No.	Package
CHWC-2	500

Part No.	E	F	H	I	J	T	Package
CHWC-3	14.95	18.7	2.4	4.5	4.4	1.2	100
CHWC-9	16.9	19.6	2.0	4.6	6.4	0.8	200

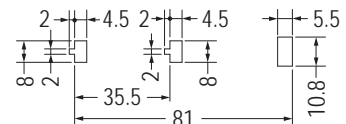
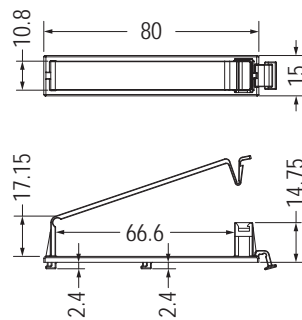
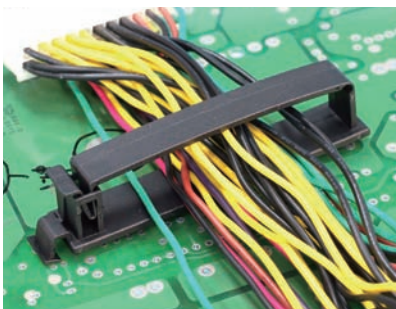

MOUNTING HOLE
THICKNESS 1.2

Part No.	Package
CHWC-6	500

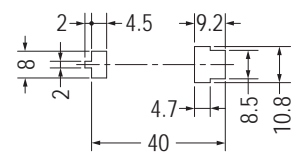
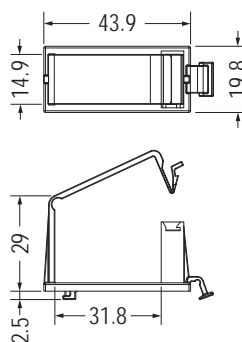

MOUNTING HOLE
THICKNESS 1.0



Part No.	Package
CHWC-10	100

電線固定座 FLAT CABLE CLAMP

用途：用於電子、電腦內部電線固定，
裝配容易，美觀不脫落。

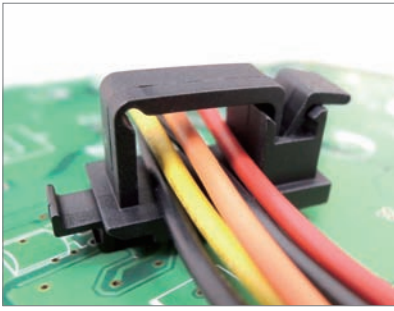

- Material: Nylon 66 (UL)
- Flame Class: 94V-2/94V-0
- Color: Natural/Black
- Unit: mm

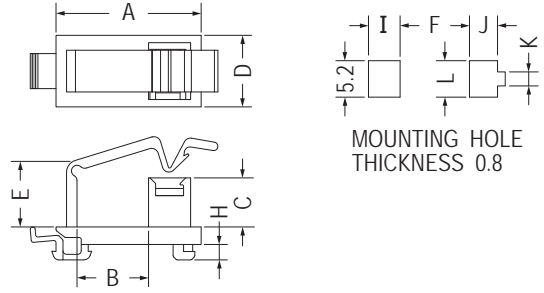

Part No.	A	B	C	D	E	F	H	I	J	K	L	Package
CHWB-1	20.7	10.3	7.0	10.2	9.51	9.9	2.2	4.5	4.0	2.0	5.2	500
CHWB-2	35.28	25.25	11.0	15.2	13.17	26.0	2.1	4.0	3.0	1.5	5.5	

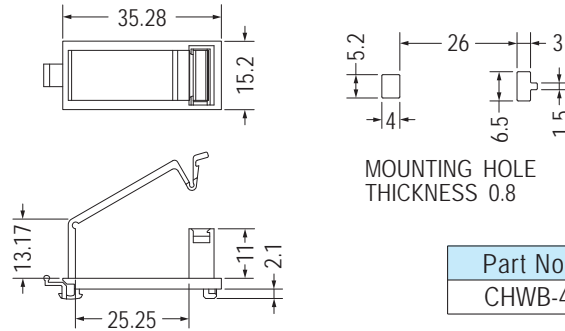
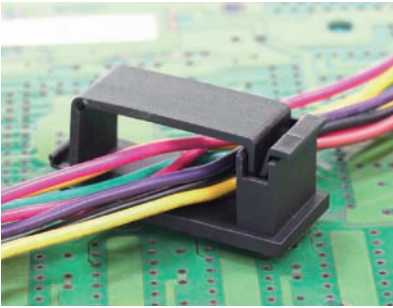

Part No.	Package
CHWB-4	500

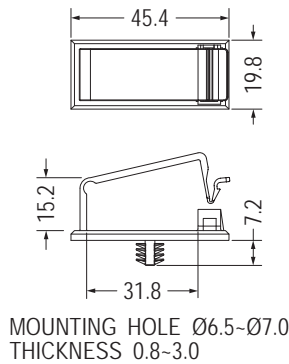

Part No.	Package
FCUT-1	500

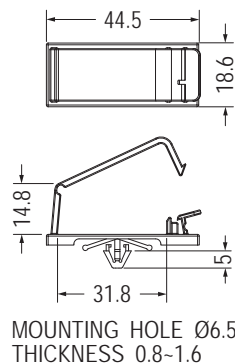

Part No.	Package
FCJA-1	200

電線固定座 FLAT CABLE CLAMP

用途：用於電子、電腦內部電線固定，裝配容易，美觀不脫落。

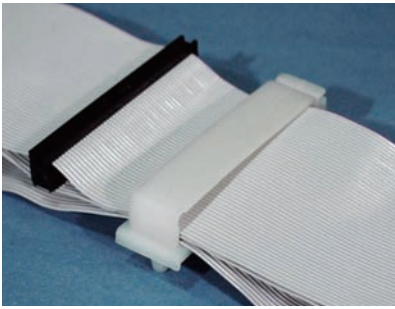

- Material: Nylon 66 (UL)
- Flame Class: 94V-2/94V-0
- Color: Natural/Black
- Unit: mm

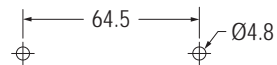
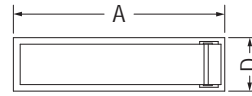

MOUNTING HOLE THICKNESS 0.8-2.2

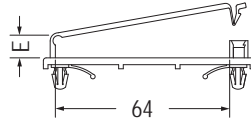

Part No.	A	D	E	Package
FCT-1	77.4	19.6	9.9	100
FCT-1L	77.0	20.0	15.0	

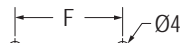
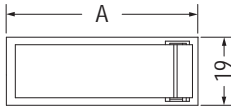

MOUNTING HOLE THICKNESS 0.8-2.2

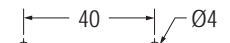
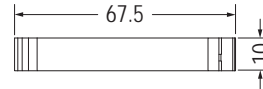

MOUNTING HOLE THICKNESS: T

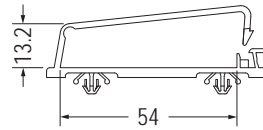
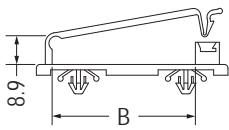

Part No.	A	B	F	Package
FCT-2	53.8	40.0	30.0	100
FCT-3	45.8	32.0	25.0	

Part No.	T	Package
FCT-4	2.0	100
FCT-4S	0.8-1.0	
FCT-4M	0.8-2.0	

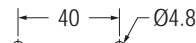
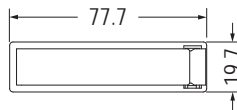

MOUNTING HOLE THICKNESS 0.8-3.2

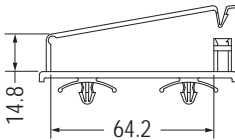

Part No.	Package
FCT-5	100

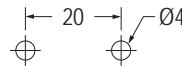
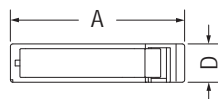

MOUNTING HOLE THICKNESS: T

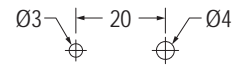

MOUNTING HOLE THICKNESS: T

【 FCT-12 】

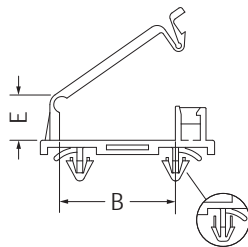

Part No.	A	B	D	E	T	Package
FCT-6	36.0	24.2	8.0	9.9	0.8-1.2	100
FCT-6L	36.1	24.2	8.0	9.9	0.8-2.0	
FCT-8	40.0	28.3	7.9	11.4	0.8-1.2	
FCT-8L	40.0	28.3	7.9	11.4	1.2-2.5	
FCT-12	36.0	24.2	8.0	9.5	0.8-1.2	

【 FCT-6L, FCT-8L 】

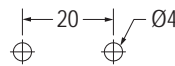
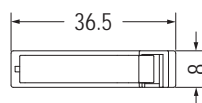

MOUNTING HOLE THICKNESS: T

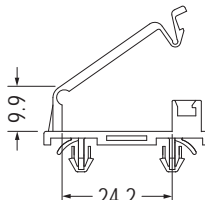

Part No.	T	Package
FCTB-1	1.2-2.5	500
FCTB-2	1.2-3.25	100

電線固定座 FLAT CABLE CLAMP

用途：用於電子、電腦內部電線固定，
裝配容易，美觀不脫落。



- Material: Nylon 66 (UL)
- Flame Class: 94V-2/94V-0
- Color: Natural/Black
- Unit: mm

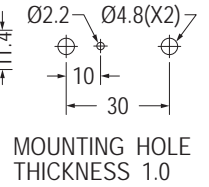
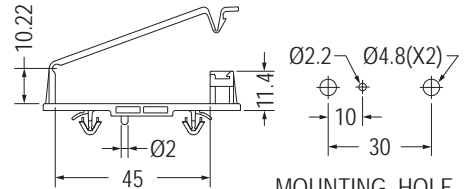
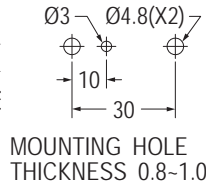
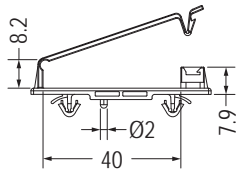
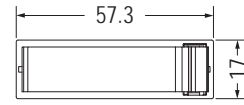
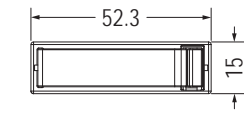

Part No.	Package
FCT-14	200

Part No.	Package
FCTG-1	200

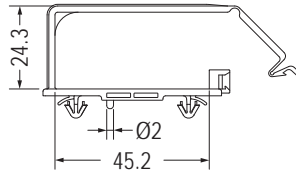
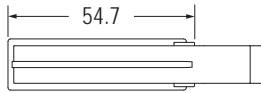

MOUNTING HOLE Ø4.8
THICKNESS 1.0

Part No.	Package
FCTE-1	100

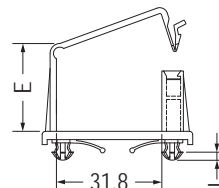
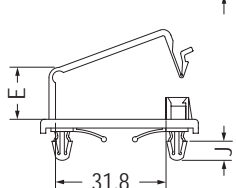
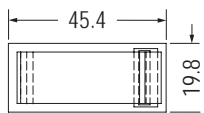

【 FCT-11 】

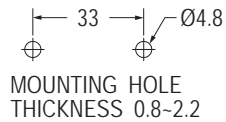

Part No.	E	J	Package
FCT-7	14.9	5.5	100
FCT-9	14.9	2.4	
★FCT-9M	26.5	4.5	
FCT-11	26.5	2.4	

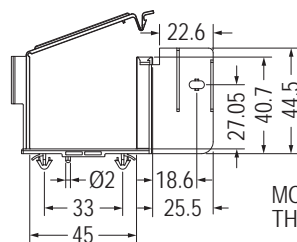
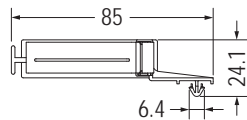

Part No.	Package
FCTF-1	50

電線固定座 FLAT CABLE CLAMP

用途：用於電子、電腦內部電線固定，裝配容易，美觀不脫落。

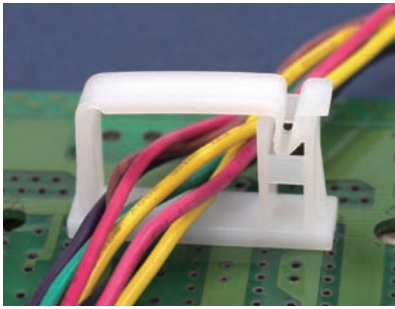

- Material: Nylon 66 (UL)
- Flame Class: 94V-2/94V-0
- Color: Natural/Black
- Unit: mm

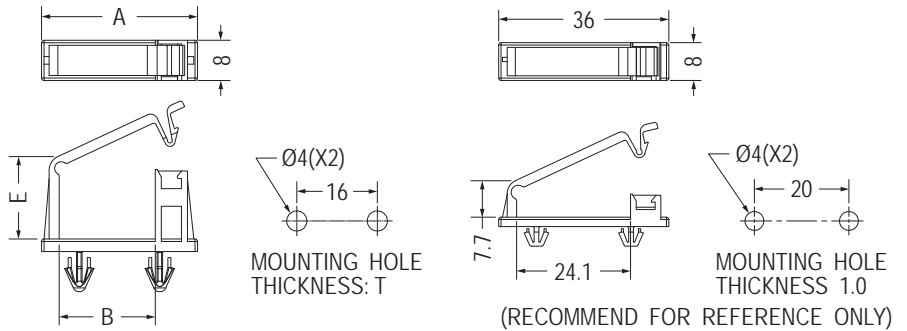

Part No.	A	B	E	T	Package
FCTC-1	31.0	19.1	16.1	3.0	100
★FCTC-4	28.0	16.6	15.2	1.0	

Part No.	Package
★FCTC-5	100

4

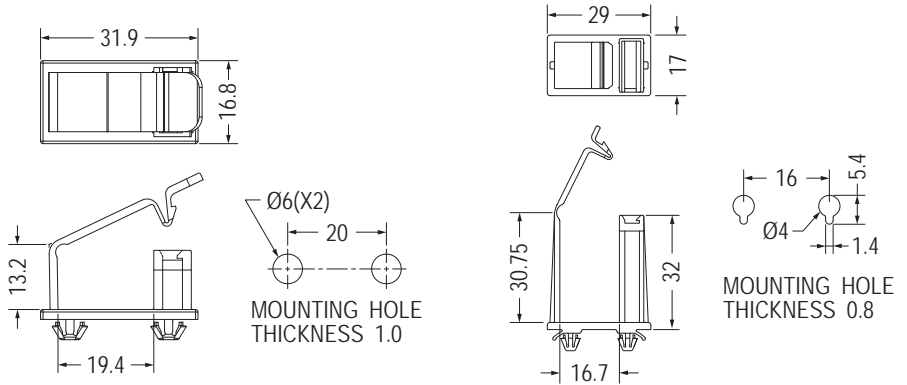

Part No.	Package
FCTC-2	200

Part No.	Package
FCTC-3	100

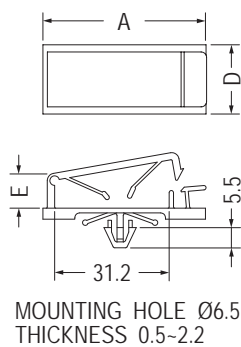

Part No.	A	D	E	Package
FCJ-30	44.3	18.8	9.4	200
FCJ-30S	44.5	19.0	13.5	

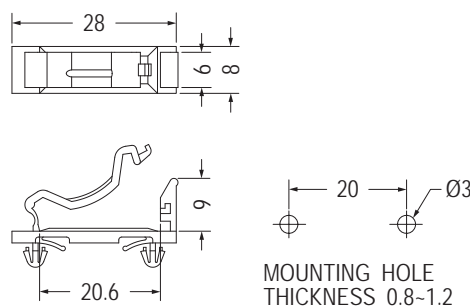

Part No.	Package
WDT-20	500

排線固定座 FLAT CABLE CLAMP

用途：用於電子、電腦內部排線固定，
裝配容易，美觀不脫落。

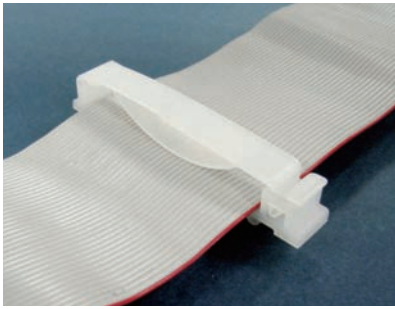

- Material: Nylon 66 (UL)
- Flame Class: 94V-2/94V-0
- Color: Natural/Black
- Unit: mm

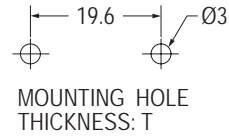
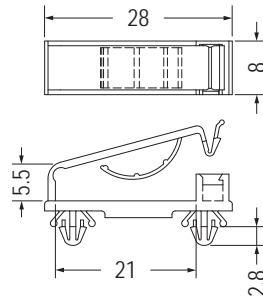

Part No.	T	Package
FDT-2	0.8-1.2	1000
FDT-2-1.6	0.8-1.6	

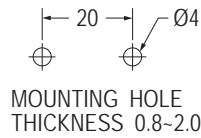
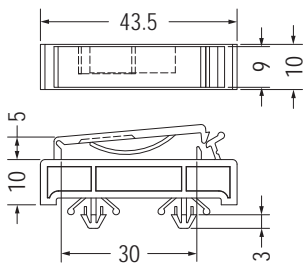

Part No.	Package
FDT-3	500

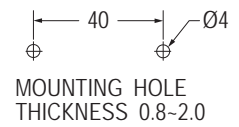
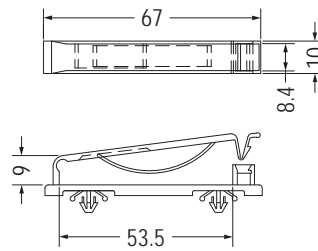

Part No.	Package
FDT-4	100

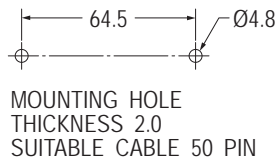
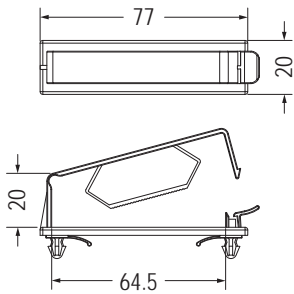

Part No.	Package
FCD-2	50

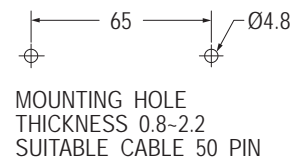
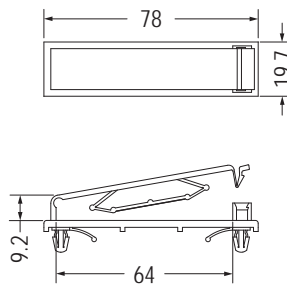

Part No.	Package
FCD-1	50

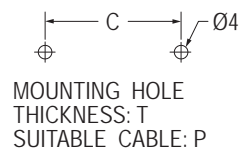
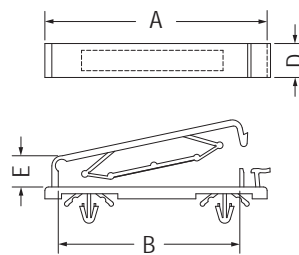

Part No.	A	B	C	D	E	T	P	Package
FCD-35	55.0	39.6	35.0	12.5	9.0	0.8-1.8	35 PIN	100
FCD-40	65.0	53.8	40.0	10.2	8.0	0.8-2.2	40 PIN	
FCD-50	77.0	64.3	49.7	10.0	9.2	0.8-2.0	50 PIN	

電線固定座 FLAT CABLE CLAMP

用途：固定電線於機殼上，方便堅固。



- Material: Nylon 66 (UL)
- Flame Class: 94V-2/94V-0
- Color: Natural/Black
- Unit: mm

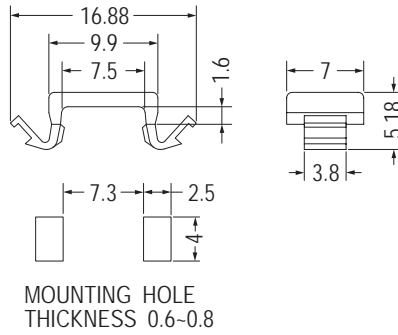

Part No.	Package
CCMH-7.5	1000

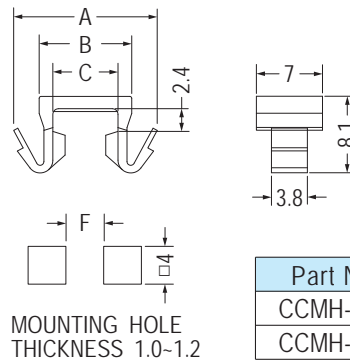

Part No.	A	B	C	F	Package
CCMH-12	15.2	9.8	6.8	4.0	1000
CCMH-15.1	18.1	12.9	10.0	7.1	

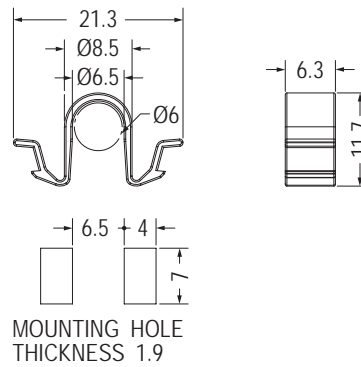

Part No.	Package
CCMHA-6	1000

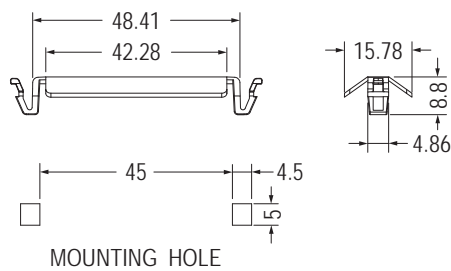

Part No.	Package
CCMH-50	500

電線固定座 FLAT CABLE CLAMP

用途：用於電子、電腦LCD-TV內部排線固定，裝配容易，美觀不脫落。

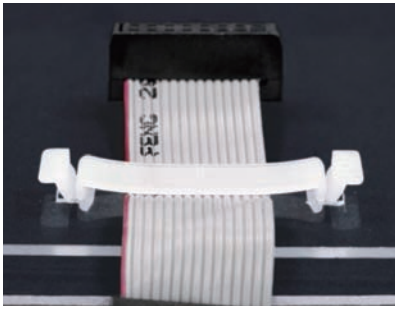

- Material: Nylon 66 (UL)
- Flame Class: 94V-2/94V-0
- Color: Natural/Black
- Unit: mm

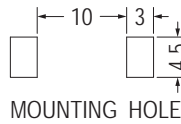
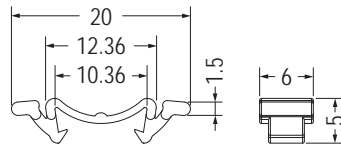

MOUNTING HOLE

Part No.	Package
CCMB-10	1000

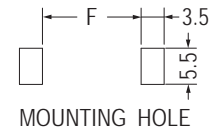
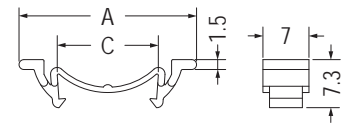

MOUNTING HOLE

Part No.	A	C	F	Package
CCMB-15	27.0	15.35	15.0	1000
CCMB-30	42.0	30.18	30.0	



- Material: PPO
- Color: Black

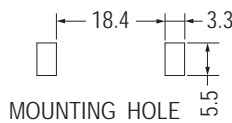
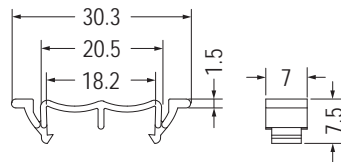

MOUNTING HOLE

Part No.	Package
CCMB-31	1000

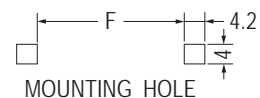
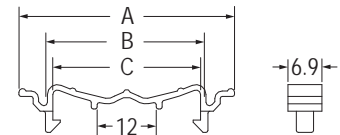

MOUNTING HOLE

Part No.	A	B	C	F	Package
CCMA-30	43.8	32.2	30.0	30.0	1000
CCMA-40	53.8	42.2	40.0	40.0	



- Material: Nylon 66 (UL)
- Flame Class: 94V-2/94V-0
- Color: Natural/Black
- Unit: mm

用途：可將電線固定於機殼上，電線不易磨損，配線整齊美觀。

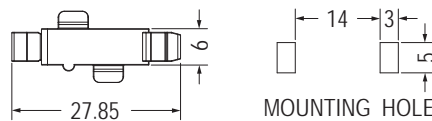

MOUNTING HOLE

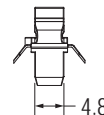
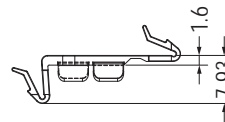

Part No.	Package
CCMD-1	1000

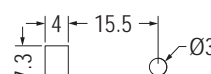

MOUNTING HOLE THICKNESS 0.8

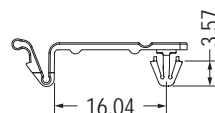

Part No.	Package
CCMC-1	1000

電線固定座 FLAT CABLE CLAMP

用途：用於電子、電腦內部電線固定，裝配容易，美觀不脫落。

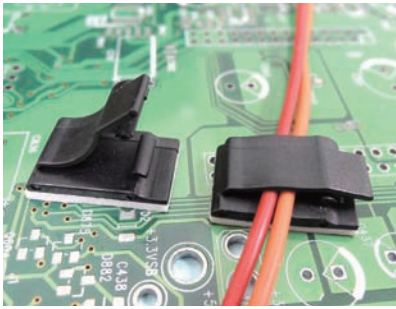

- Material: Nylon 66 (UL)
- Flame Class: 94V-2/94V-0
- Color: Natural/Black
- Unit: mm

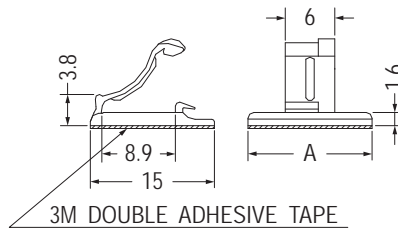

Part No.	A	Package
WDF-1	15.0	1000
WDF-3	6.0	

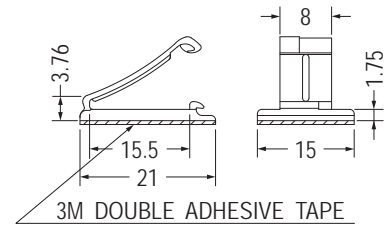

Part No.	Package
WDF-2	1000

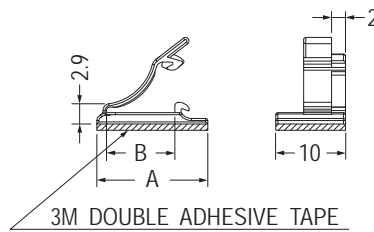

Part No.	A	B	Package
WDF-6	15.9	9.8	1000
WDF-7	17.6	11.5	

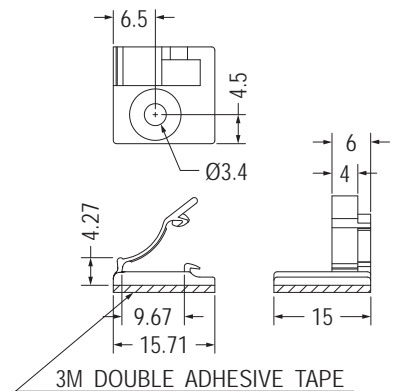

Part No.	Package
WDF-4	1000

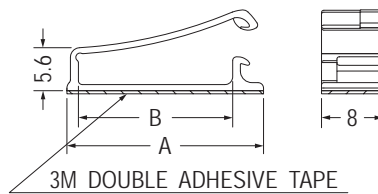
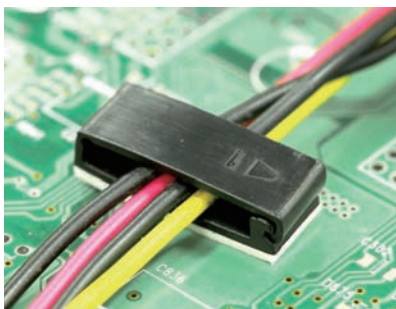

Part No.	A	B	Package
WDF-8	25.5	20.0	1000
WDF-9	35.5	30.0	

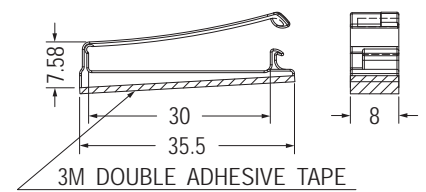

Part No.	Package
WDF-10	1000

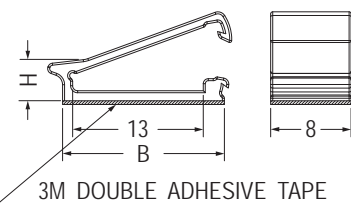

Part No.	B	H	Package
WCD-1	16.1	4.0	1000
WCD-4	17.0	8.0	

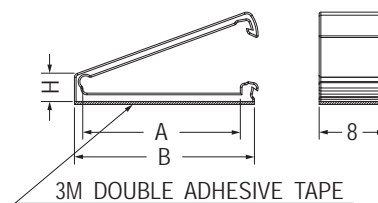

Part No.	A	B	H	Package
WCD-2	19.0	21.7	3.38	1000
WCD-3	18.5	21.85	4.87	

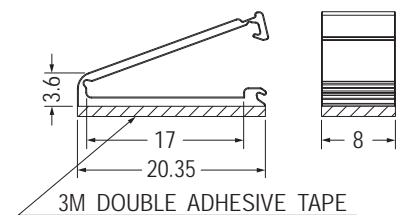

Part No.	Package
WCD-5	1000

電線固定座 CABLE CLAMP

用途：背膠式，可快速拆卸，固定電線維修方便，不佔空間。



- Material: Nylon 66 (UL)
- Flame Class: 94V-2/94V-0
- Color: Natural/Black
- Unit: mm

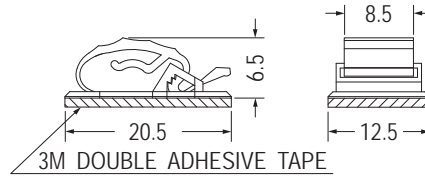

Part No.	Package
WCA-1	1000

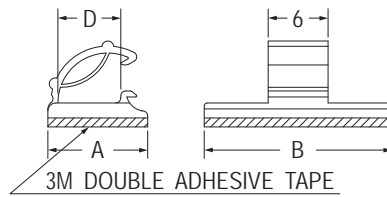
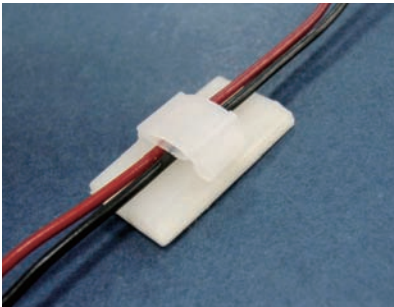

Part No.	A	B	D	Package
WCC-1	10.0	19.0	6.3	1000
WCC-1S	10.0	11.0	6.3	
WCC-2	14.0	19.0	10.5	500
WCC-8	10.0	19.5	6.0	1000

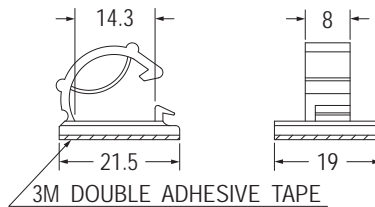

Part No.	Package
WCC-3	500

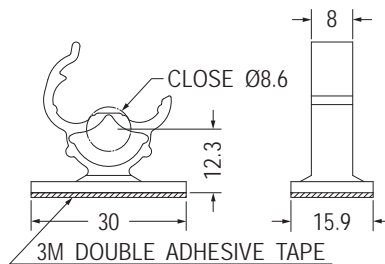

Part No.	Package
WSK-1	250

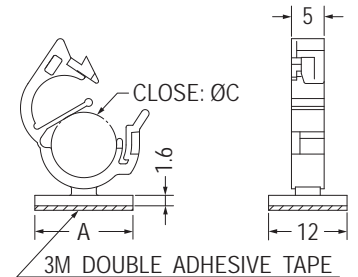

Part No.	A	C	Package
CHO-7.6	15.0	7.6	500
CHO-10	19.0	10.0	
CHO-12	20.0	12.0	

電線固定座 CABLE CLAMP

用途：小型化，背膠式，可快速捆紮及解開電線。

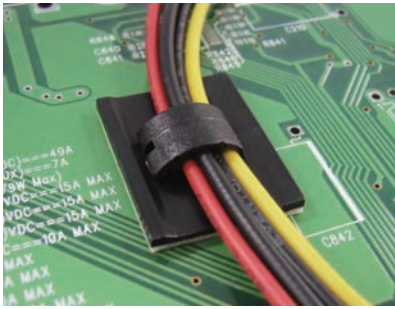

- Material: Nylon 66 (UL)
- Flame Class: 94V-2/94V-0
- Color: Natural/Black
- Unit: mm

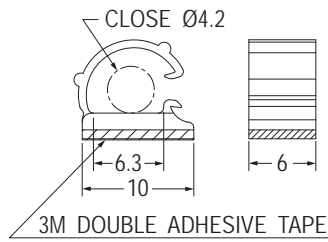

Part No.	Package
WCC-5	1000

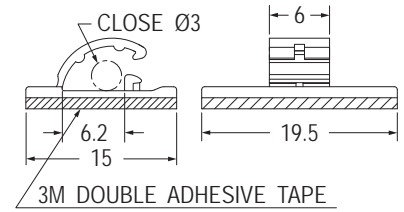

Part No.	Package
WCC-6	1000

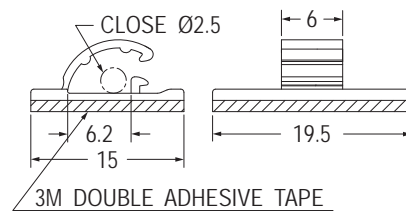
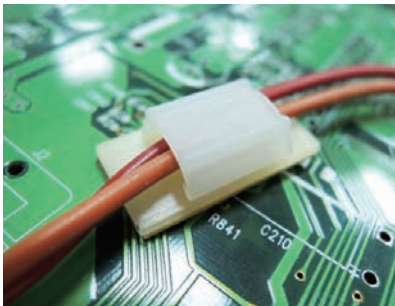

Part No.	Package
WCC-7	1000

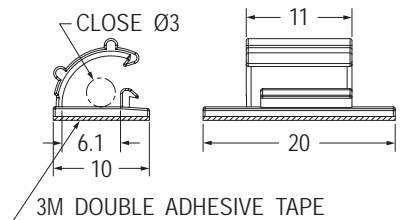

Part No.	Package
WCC-9	500



- Material: Nylon 66 (UL)
- Flame Class: 94V-2/94V-0
- Color: Natural/Black
- Unit: mm

用途：固定電線於機板上，維修方便，不佔空間。

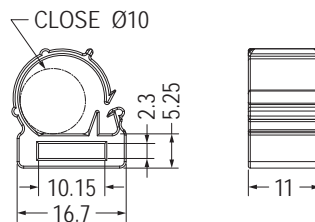

Part No.	Package
MISD-1	500

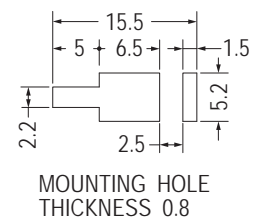
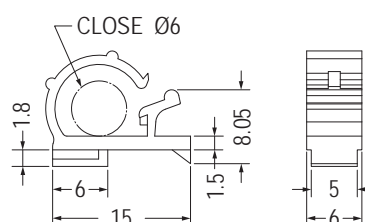

Part No.	Package
MISA-3	1000

電線固定座 CABLE CLAMP

用途：背膠式，可快速拆卸，固定電線維修方便，不佔空間。

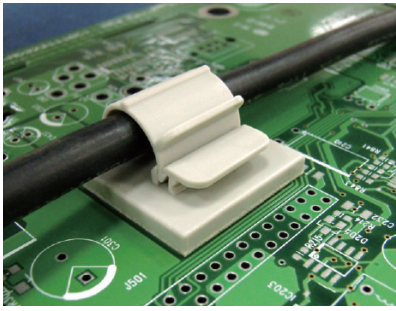

- Material: Nylon 66 (UL)
- Flame Class: 94V-2/94V-0
- Color: Natural/Black
- Unit: mm

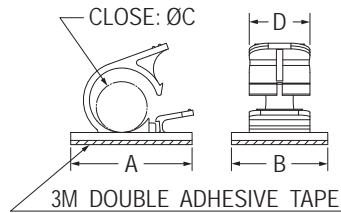
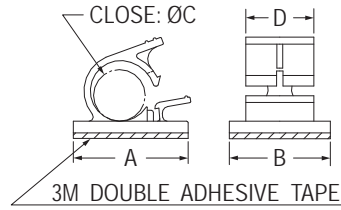

【 FWU-11 】

Part No.	A	B	C	D	Package
FWU-1	13.0	10.0	4.0	6.8	1000
FWU-2	15.0	13.0	6.0	9.0	
FWU-3	21.6	19.0	9.0	12.8	500
FWU-4	25.0	20.0	11.0	13.2	250
FWU-5	32.0	25.4	13.4	16.0	200
FWU-6	35.8	24.8	18.0	16.8	100
FWU-7	56.1	50.0	25.4	20.1	50
FWU-8	56.1	50.0	30.0	20.1	
FWU-9	37.6	31.5	18.0	17.0	100
FWU-10	31.0	19.0	9.0	12.8	200
FWU-11	13.0	10.0	5.0	6.8	1000

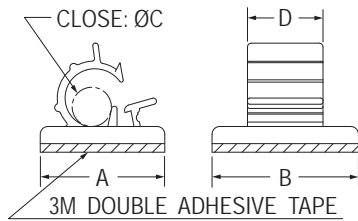

Part No.	A	B	C	D	Package
FWAS-1	16.4	19.3	5.0	9.7	500
FWAS-2	25.3	25.4	11.0	16.1	250
FWAS-3	37.0	29.3	19.6	16.9	100
FWAS-4	57.1	50.5	26.8	31.7	50
FWAS-5	22.1	25.4	6.35	16.0	250
FWAS-6	30.73	25.4	12.7	16.26	100

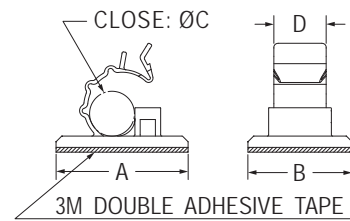

Part No.	A	B	C	D	Package
FWC-6	17.5	20.5	6.2	8.6	200
FWC-7	25.5	17.5	7.0	9.8	
FWC-10	30.3	23.9	10.3	12.0	
FWC-10S	30.0	21.0	10.0	12.0	
FWC-15	29.9	23.9	14.5	14.0	
FWC-19	35.7	25.2	18.5	15.9	

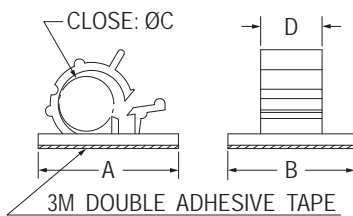

Part No.	A	B	C	D	Package
FWS-1	21.0	19.0	8.2	9.2	500
FWS-2	25.0	20.0	9.0	12.0	250
FWS-3	25.0	19.7	10.6	12.1	
FWS-4	29.0	20.0	12.6	14.0	
FWS-7	29.6	19.5	12.8	14.8	
FWS-8	21.6	17.0	10.4	12.0	500
FWS-10	19.0	19.0	6.8	8.8	

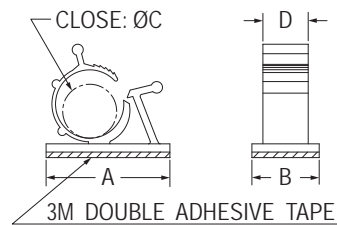

Part No.	A	B	C	D	Package	UL
AWC-1	24.8	18.8	7.9-10.3	10.2	250	UL
AWC-2	25.4	15.0	11.0-13.3	10.0		UL
AWC-2A	30.2	15.0	11.9-14.3	10.0	100	/
AWC-3	34.4	18.8	14.7-19.1	12.7		UL
AWC-4	36.0	19.0	18.0-22.0	12.7		UL
AWC-5	39.8	19.8	22.0-26.5	13.0	250	UL
AWC-6	31.8	19.1	11.9-14.3	10.2		/

電線固定座 CABLE CLAMP

用途：固定電線於PC板或機板上，維修方便，不佔空間。



- Material: Nylon 66 (UL)
- Flame Class: 94V-2/94V-0
- Color: Natural/Black
- Unit: mm

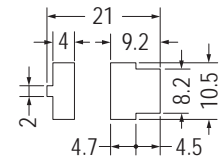
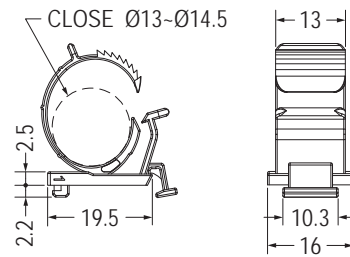

MOUNTING HOLE THICKNESS 0.8-1.0

Part No.	Package
AWE-1	500

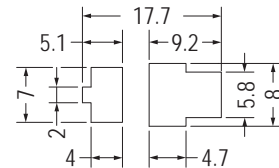
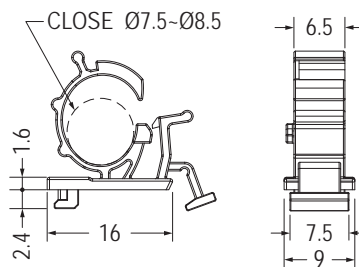

MOUNTING HOLE THICKNESS 0.9-1.1

Part No.	Package
AWE-2	500

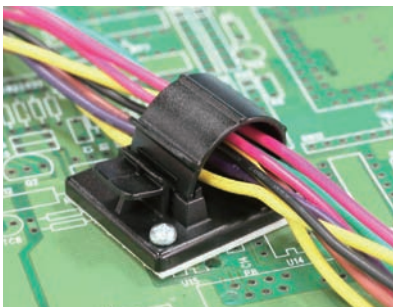

- Material: Nylon 66 (UL)
- Flame Class: 94V-2/94V-0
- Color: Natural/Black
- Unit: mm

用途：背膠式，亦可配合螺絲，固定電線，美觀不脫落。

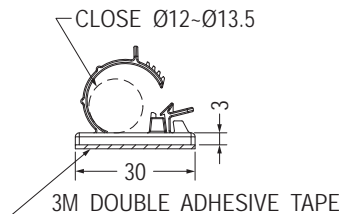
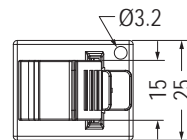

Part No.	Package
FWD-1	1000



- Material: Nylon 66 (UL)
- Flame Class: 94V-2/94V-0
- Color: Natural/Black
- Unit: mm

用途：配合螺絲，固定電線，美觀不脫落。

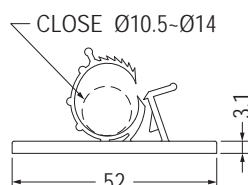
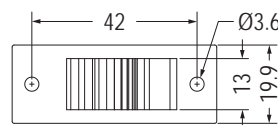

Part No.	Package
AWCA-1	1000

電線固定座 CABLE CLAMP

用途：用於機器上之電線固定。

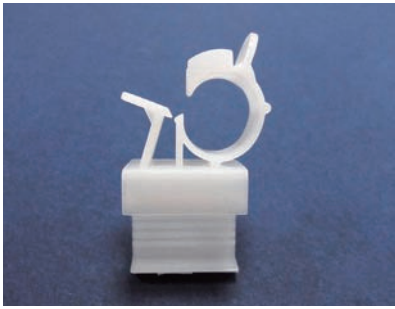

- Material: Nylon 66 (UL)
- Flame Class: 94V-2/94V-0
- Color: Natural/Black
- Unit: mm

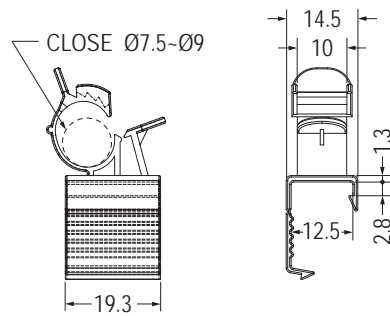

Part No.	Package
AWCB-1	500



- Material: Nylon 66 (UL)
- Flame Class: 94V-2/94V-0
- Color: Natural/Black
- Unit: mm

用途：用於C.R.T消磁線圈之固定。

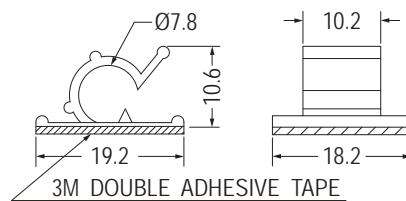

Part No.	Package
WC-1	500

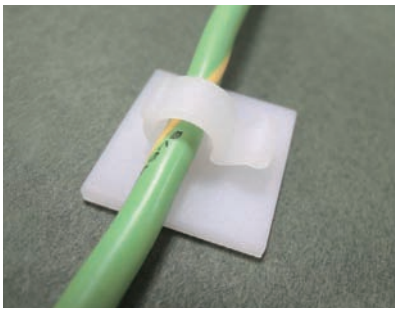

- Material: Nylon 66 (UL)
- Flame Class: 94V-2/94V-0
- Color: Natural/Black
- Unit: mm

用途：背膠式，可快速拆卸，固定電線維修方便，不佔空間。

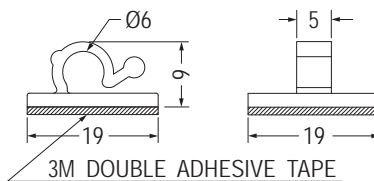

Part No.	Package
WRA-6	1000

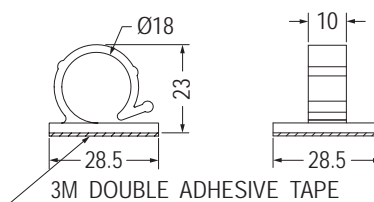
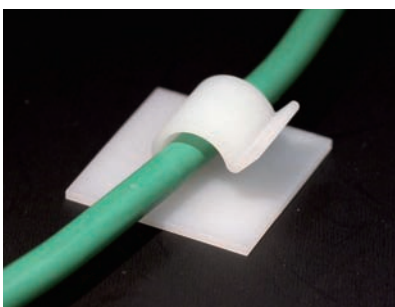

Part No.	Package
WRA-18	500

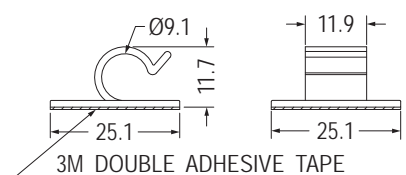

Part No.	Package
WCL-30	500

電線固定座 WIRE CLIP

用途：背膠式，固定電線於機器中，整齊美觀。



- Material: Nylon 66 (UL)
- Flame Class: 94V-2/94V-0
- Color: Natural/Black
- Unit: mm

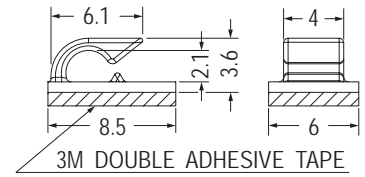
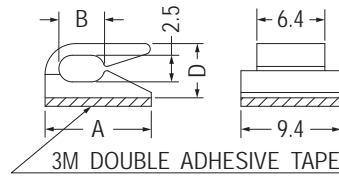

Part No.	A	B	D	Package
WC-6	10.0	4.3	5.1	1000
WC-7	12.0	6.25	5.5	

Part No.	Package
WC-12	1000

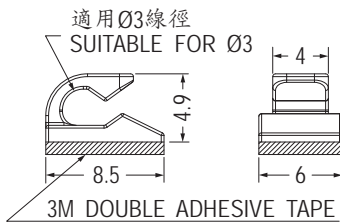

Part No.	Package
MWS-37	1000

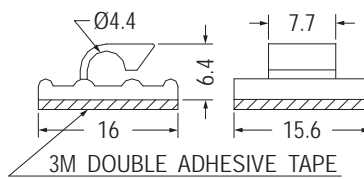

Part No.	Package
WC-5	1000

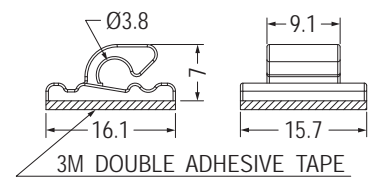

Part No.	Package
WC-10	1000

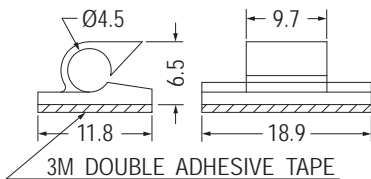

Part No.	Package
WCL-11	1000

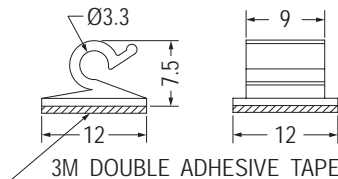

Part No.	Package
WCL-12	1000

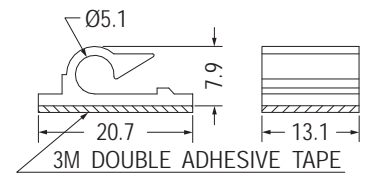

Part No.	Package
WCL-1	500

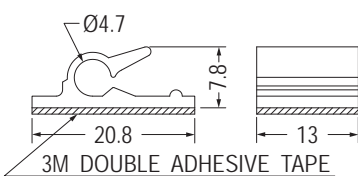

Part No.	Package
WCL-13	1000

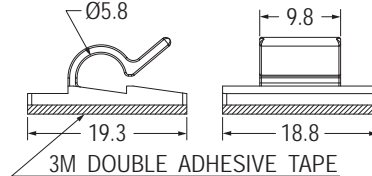

Part No.	Package
WCL-15	500

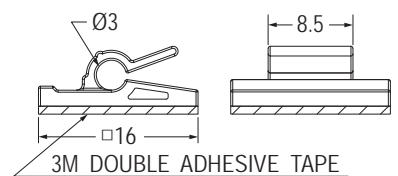

Part No.	Package
WCL-29	1000

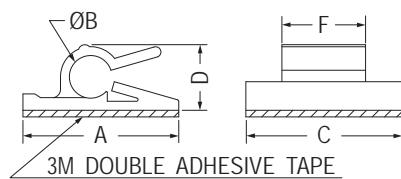

Part No.	A	B	C	D	F	Package
WCT-4	15.9	4.0	15.9	5.7	9.7	500
WCT-5	19.0	5.2	19.0	8.0	10.2	
WCT-6	19.0	6.0	20.0	9.9	10.0	

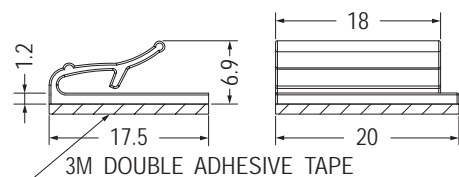

Part No.	Package
WCL-23	500

電線固定座 WIRE CLIP

用途：背膠式，固定電線於機器中，整齊美觀。

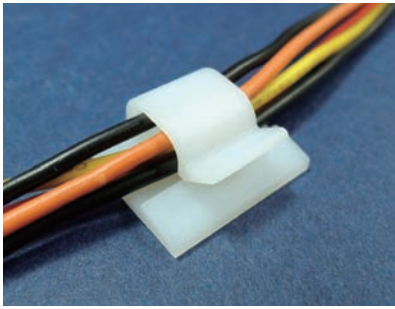

- Material: Nylon 66 (UL)
- Flame Class: 94V-2/94V-0
- Color: Natural/Black
- Unit: mm

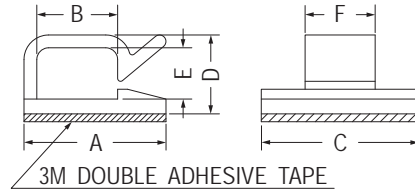

Part No.	A	B	C	D	E	F	Package
WCL-4	14.4	8.2	16.0	8.0	5.2	7.1	1000
WCL-5	16.8	10.2	16.0	9.5	6.7	7.0	500
WCL-7	20.8	13.6	19.0	11.3	8.2	9.0	1000
WCL-14	15.4	9.9	16.0	7.3	4.7	7.0	1000
WCL-27	20.1	15.8	16.0	9.3	6.5	9.0	500
WCL-28	22.7	18.0	20.0	8.7	6.0	10.0	500

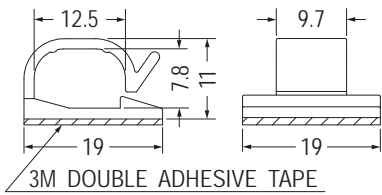

Part No.	Package
WCL-6	500

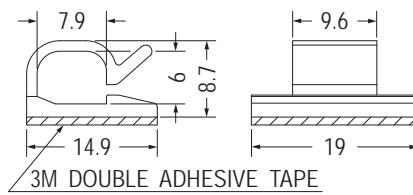

Part No.	Package
WCL-18	1000

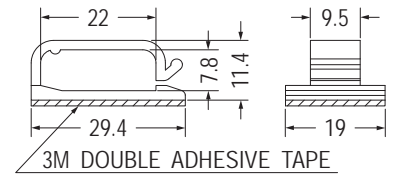

Part No.	Package
WCL-31	500

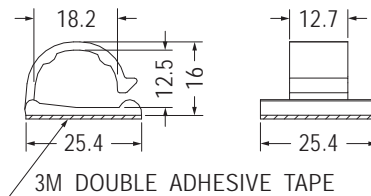

Part No.	Package
WCL-10	250

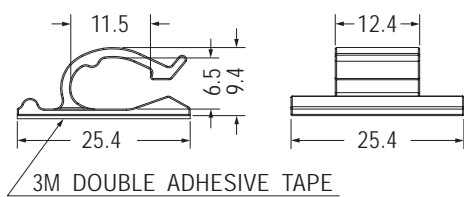

Part No.	Package
WCL-24	500

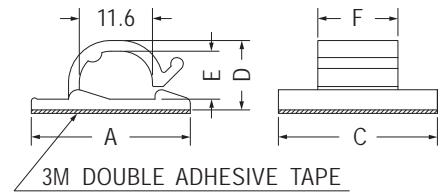

Part No.	A	C	D	E	F	Package
WCL-8	25.4	15.5	11.3	7.8	6.5	500
WCL-9	25.2	25.2	11.0	7.6	12.7	500

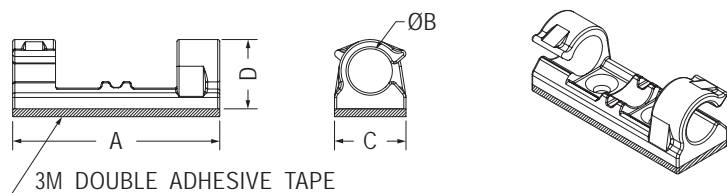

Part No.	A	B	C	D	Package
WCL-25	29.0	6.2	10.0	9.7	500
WCL-26	33.0	9.0	13.0	12.7	500

電線固定座 WIRE SADDLE

用途：背膠式，可快速拆卸，固定電線
維修方便，整齊美觀，不佔空間。

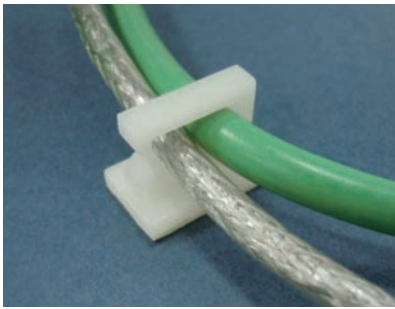

- Material: Nylon 66 (UL)
- Flame Class: 94V-2/94V-0
- Color: Natural/Black
- Unit: mm

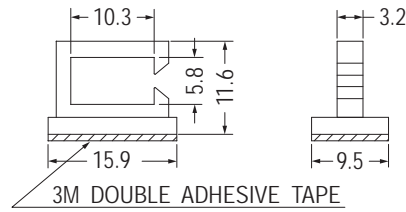

Part No.	Package
WSS-1	1000

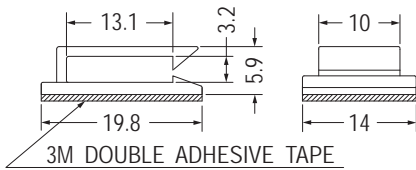

Part No.	Package
MWS-30	1000

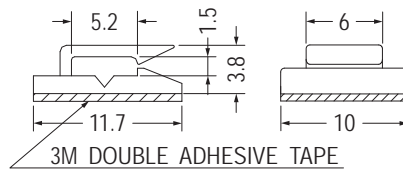

Part No.	Package
WCLA-1	1000

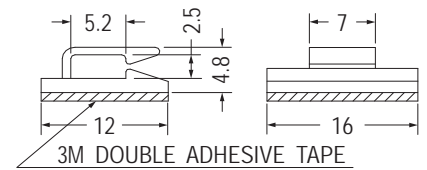

Part No.	Package
WC-4	1000

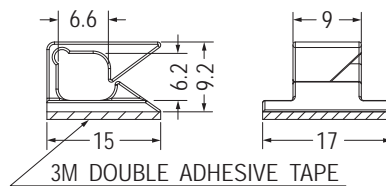
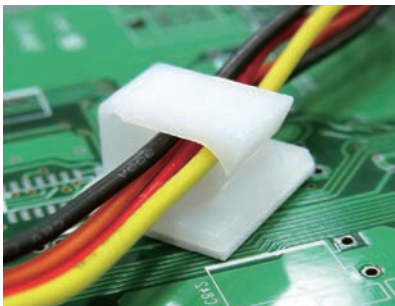

Part No.	Package
WSB-4	1000

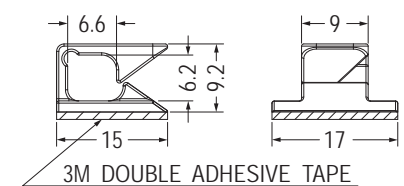

Part No.	Package
WSB-6	1000

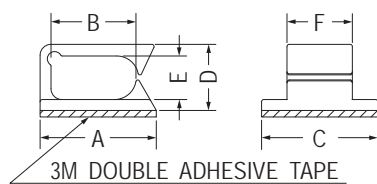

Part No.	A	B	C	D	E	F	Package
WSB-1	12.0	6.2	12.1	6.3	3.6	9.1	1000
WSB-2	16.0	11.7	16.0	9.1	6.0	9.0	
WSB-3	14.1	7.6	15.8	9.1	6.1	9.0	
WSB-5	14.0	10.5	12.1	6.25	3.5	10.0	

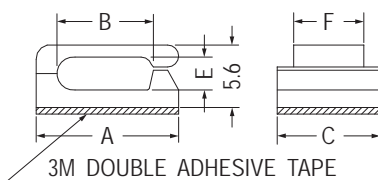

Part No.	A	B	C	E	F	Package
MWS-2	13.0	8.5	9.2	3.0	6.3	1000
MWS-3	16.0	11.5	13.0	2.9	9.0	

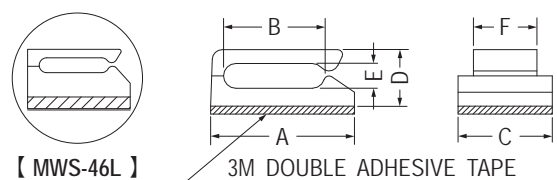

Part No.	A	B	C	D	E	F	Package
MWS-2D	14.5	10.2	9.5	5.7	2.5	6.4	1000
MWS-27	12.5	8.4	9.5	5.2	2.8	6.5	
MWS-45	12.7	8.1	12.7	5.0	2.5	6.4	
MWS-46	9.8	6.65	9.5	3.85	1.4	6.4	
MWS-46L	9.7	6.45	9.5	4.5	1.4	6.4	

電線固定座 WIRE SADDLE

用途：背膠式，可快速拆卸，固定電線維修方便，整齊美觀，不佔空間。

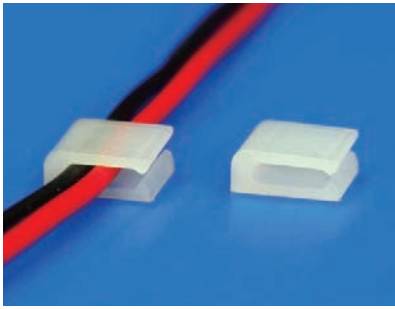

- Material: Nylon 66 (UL)
- Flame Class: 94V-2/94V-0
- Color: Natural/Black
- Unit: mm

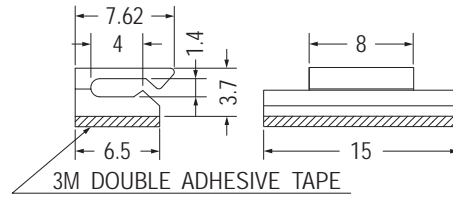

Part No.	Package
MWS-22	1000

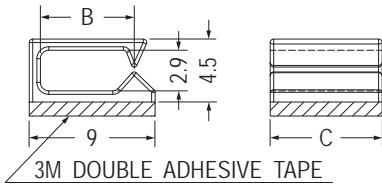

Part No.	B	C	Package
MWS-32	6.7	8.0	1000
MWS-42	6.73	4.0	

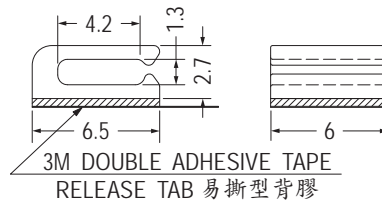

Part No.	Package
MWS-52	1000

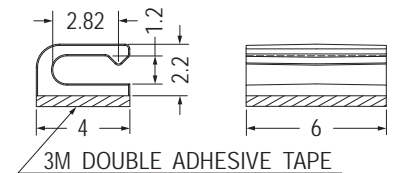

Part No.	Package
MWS-43	1000

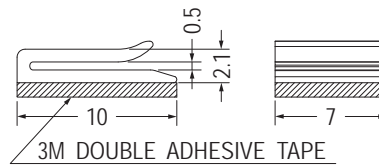

Part No.	Package
MWS-33	1000

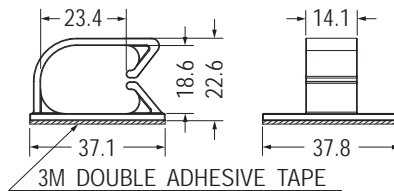

Part No.	Package
MWS-54	100

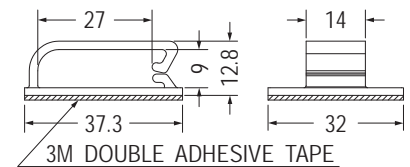

Part No.	Package
MWS-49	250

電線固定座 WIRE CLIP

用途：可背膠或使用螺絲固定，可快速拆卸，固定電線維修方便，不佔空間。

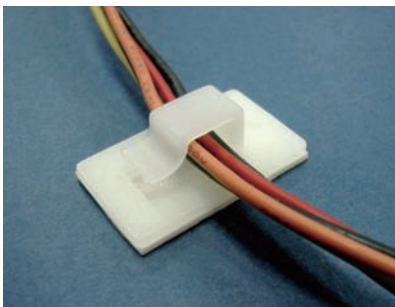

- Material: Nylon 66 (UL)
- Flame Class: 94V-2/94V-0
- Color: Natural/Black
- Unit: mm

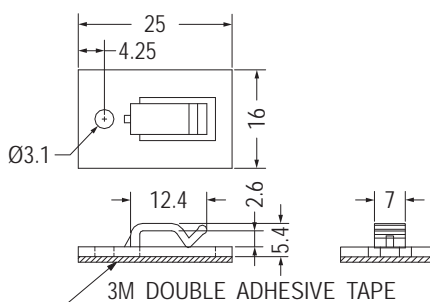

Part No.	Package
WCS-1	500

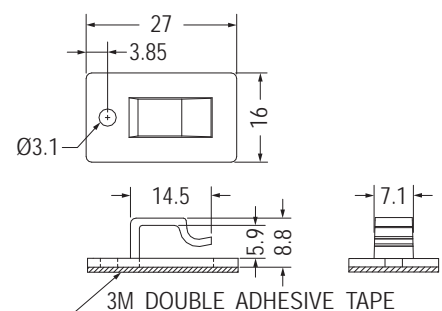

Part No.	Package
WCS-2	500

電線固定座 FLAT CABLE CLAMP

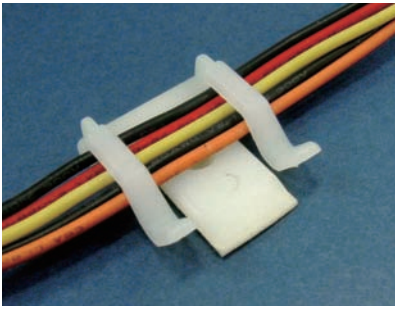

- Material: Nylon 66 (UL)
- Flame Class: 94V-2/94V-0
- Color: Natural/Black
- Unit: mm

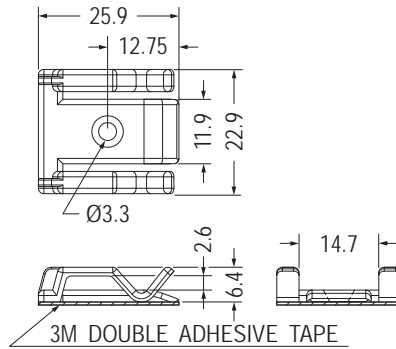

Part No.	Package
FCP-25	500

用途：可背膠或使用螺絲固定，可快速拆卸，固定電線維修方便，不佔空間。

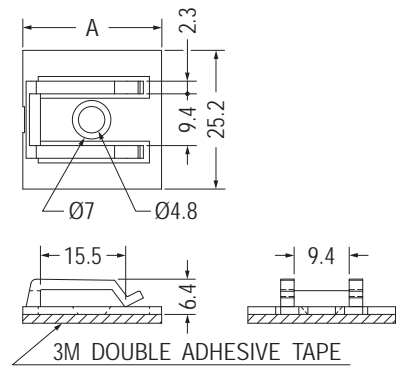

Part No.	A	Package
FCP-22	25.2	500
FCP-22S	24.2	

電線固定座 WIRE CLIP

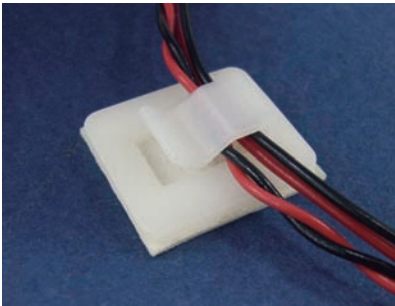

- Material: Nylon 66 (UL)
- Flame Class: 94V-2/94V-0
- Color: Natural/Black
- Unit: mm

用途：背膠式，可快速拆卸，固定電線維修方便，不佔空間。

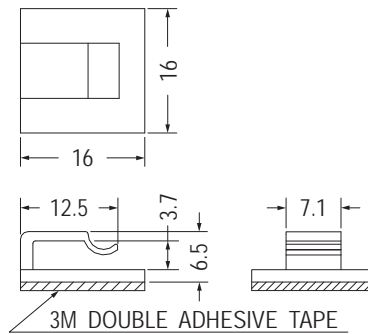

Part No.	Package
WCS-3	500

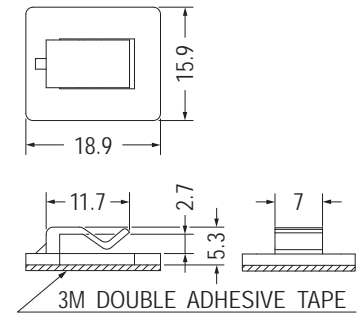

Part No.	Package
WCS-4	500

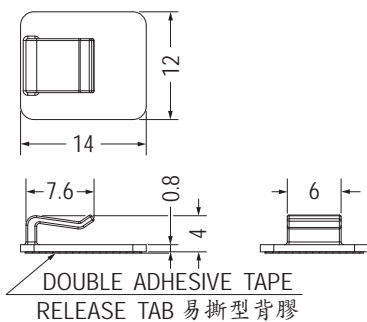

Part No.	Package
MIBB-18	500

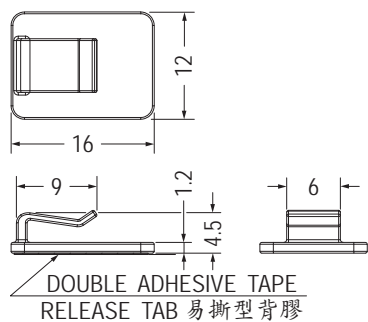

Part No.	Package
MIBB-10	500

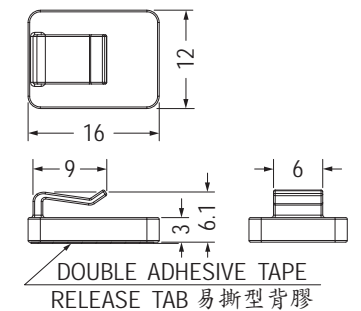

Part No.	Package
MIBB-14	500

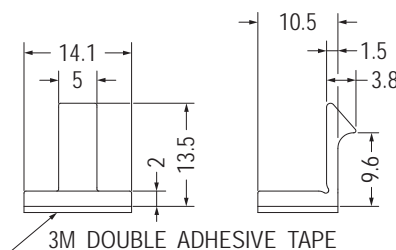

Part No.	Package
WCLL-1	500

電線固定座 WIRE CLIP

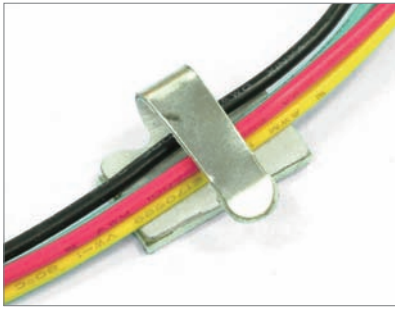

- Material: Steel
- Unit: mm

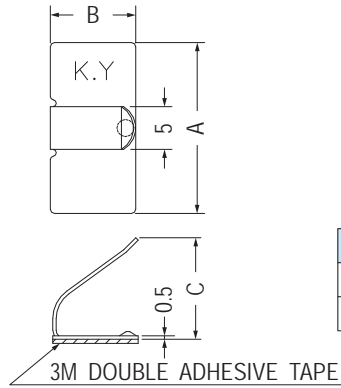

用途：背膠式，可快速捆紮電線安裝容易，經特殊處理，不刮手，不會刮傷電線。

Part No.	A	B	C	Package
WCM-1	20.0	10.0	11.6	1000
WCM-2	25.0	15.0	17.1	500

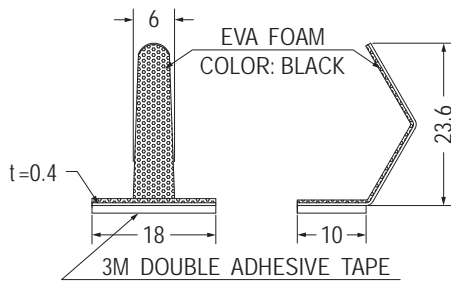

- Material: SPTE

Part No.	Package
WCM-5L	1000

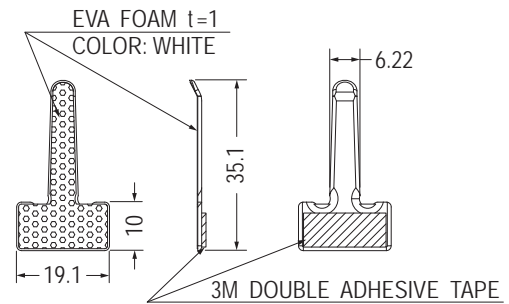

- Material: SPTE

Part No.	Package
WCM-9A	1000

電線固定板 WIRE CLIP

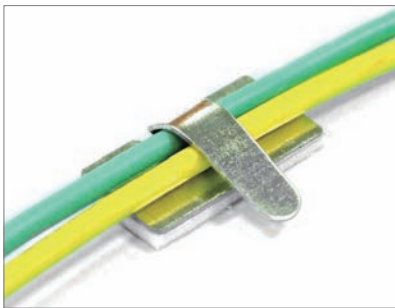

- Material: Aluminum
- Unit: mm

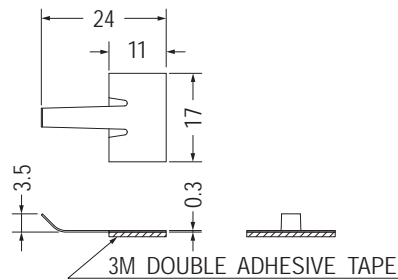

Part No.	Package
WCM-11	1000

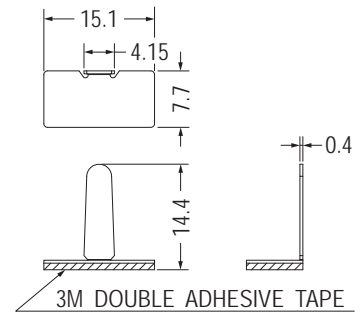

- Material: SPTE

Part No.	Package
WCM-10	1000

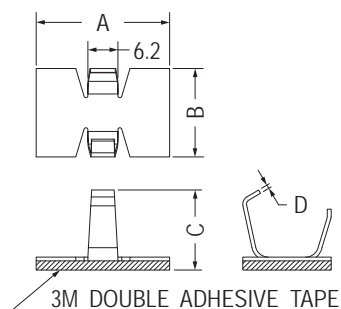
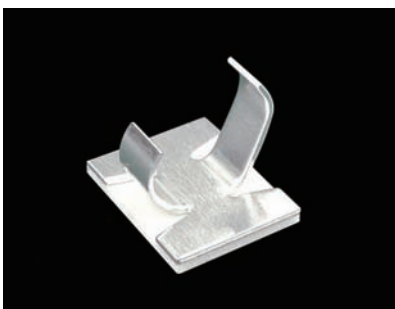

Part No.	A	B	C	D	Package
ALACO-01	16.0	10.6	9.4	0.45	500
ALACO-02	19.0	16.0	14.9	0.7	

電線固定座 WIRE SADDLE

用途：背膠式，可快速拆卸，固定電線維修方便，不佔空間。

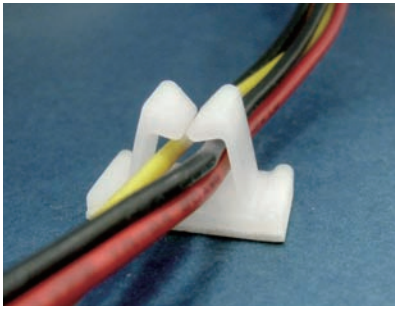

- Material: Nylon 66 (UL)
- Flame Class: 94V-2/94V-0
- Color: Natural/Black
- Unit: mm

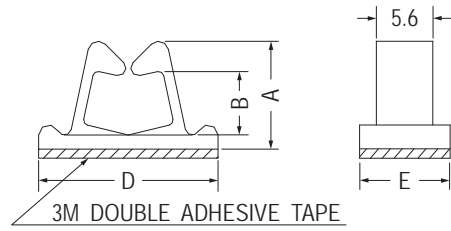

Part No.	A	B	D	E	Package
WT-2	10.7	6.3	17.8	8.9	1000
WT-2L	10.8	6.5	25.5	12.6	

4

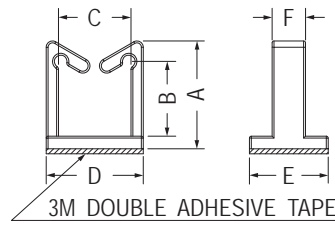
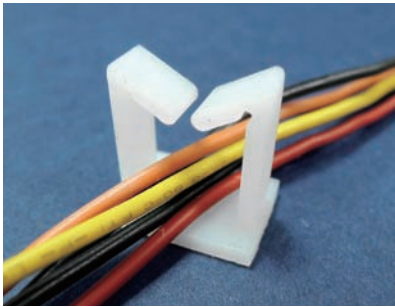

【 WT-5, WT-8 】

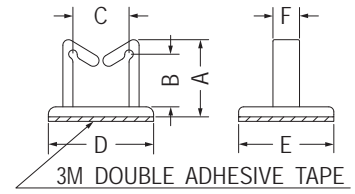

【 WT-9 】

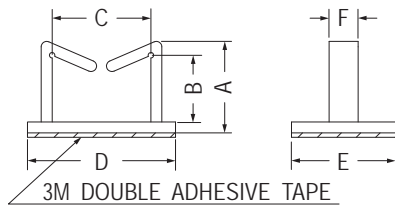

Part No.	A	B	C	D	E	F	Package
WT-1	17.2	12.2	11.5	21.0	19.0	5.3	500
WT-3	16.7	12.16	18.0	27.0	19.0	5.3	
WT-4	26.0	21.2	11.5	21.0	19.0	5.3	
WT-5	17.1	11.5	11.5	15.4	12.5	5.3	
WT-6	17.0	12.17	11.5	17.0	12.5	5.3	
WT-8	17.5	12.7	16.5	20.5	19.0	7.0	
WT-9	15.4	10.5	11.2	21.0	19.0	5.3	

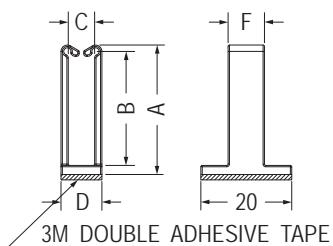

Part No.	A	B	C	D	F	Package
WT-7	28.5	25.1	5.8	9.0	8.0	500
WT-10	19.2	15.45	6.8	10.0	5.0	

電線固定座 WIRE SADDLE



- Material: Nylon 66 (UL)
- Flame Class: 94V-2/94V-0
- Color: Natural/Black
- Unit: mm

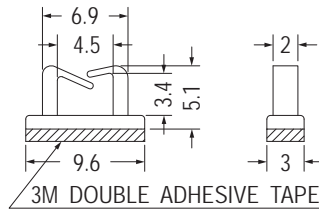

Part No.	Package
WLL-14	1000

用途：超小型，背膠式，可快速固定及解開電線。

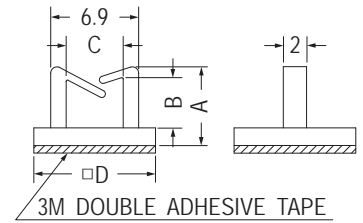

Part No.	A	B	C	D	Package
WLL-1	6.5	3.8	4.5	9.6	1000
WLL-1S	6.2	4.23	4.3	9.6	
WLL-13	6.2	4.23	4.3	8.5	
WLL-16	6.5	4.3	4.5	9.5	

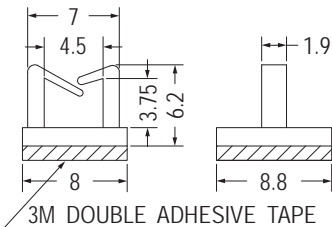

Part No.	Package
WLL-24	1000

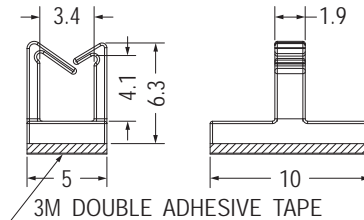

Part No.	Package
WLL-19	1000

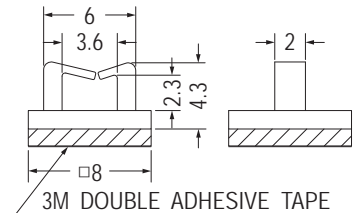

Part No.	Package
WLL-20	1000

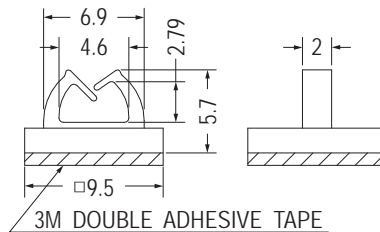
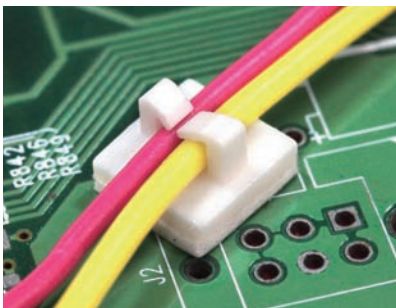

Part No.	Package
WLL-2	1000

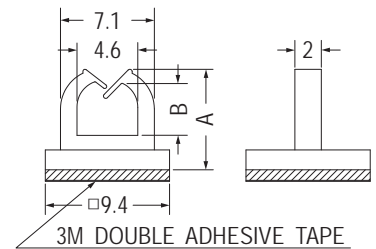

Part No.	A	B	Package
WLL-6	7.6	3.94	1000
WLL-6L	9.3	5.64	

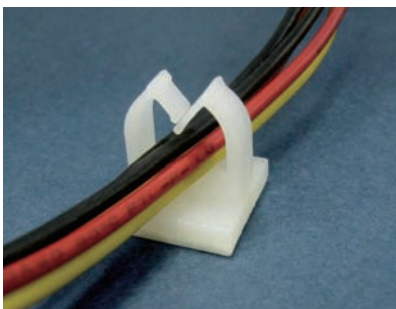

- Material: Nylon 66 (UL)
- Flame Class: 94V-2/94V-0
- Color: Natural/Black
- Unit: mm

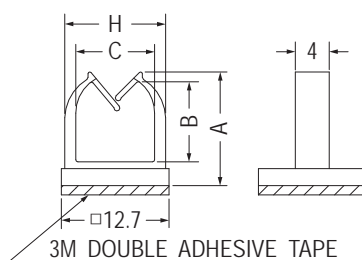

用途：背膠式，可快速拆卸，固定電線維修方便，不佔空間。

Part No.	A	B	C	H	Package
WLL-3	13.4	9.46	9.3	11.9	1000
WLL-21	9.3	5.5	6.6	9.0	
WLL-22	11.2	7.3	8.0	10.8	
WLL-23	15.0	11.1	9.2	12.0	

電線固定座 WIRE SADDLE

用途：背膠式，可快速拆卸，固定電線維修方便，不佔空間。

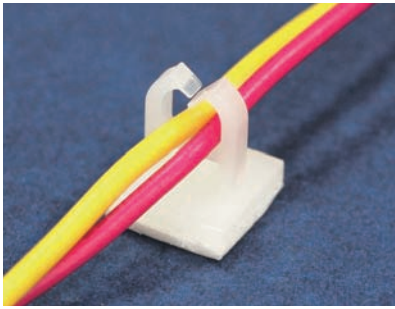

- Material: Nylon 66 (UL)
- Flame Class: 94V-2/94V-0
- Color: Natural/Black
- Unit: mm

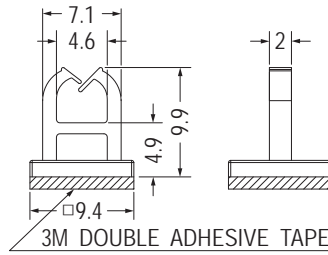

Part No.	Package
WLL-17	1000

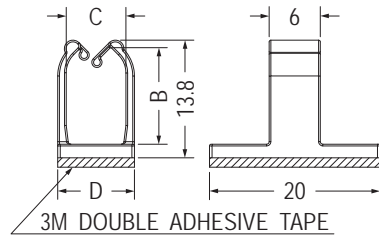

Part No.	B	C	D	Package
WLL-9	11.31	7.0	9.0	1000
WLL-18	11.18	6.0	8.0	

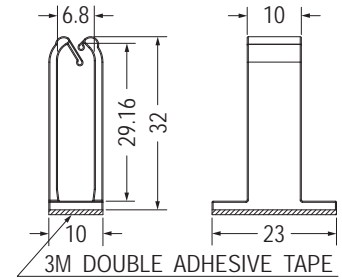

Part No.	Package
WLL-10	500

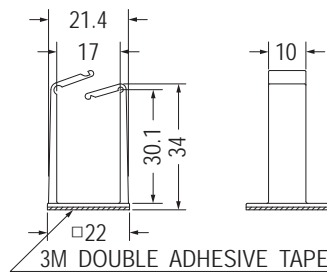
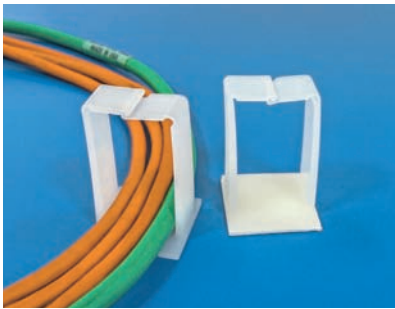

Part No.	Package
WLU-4	200

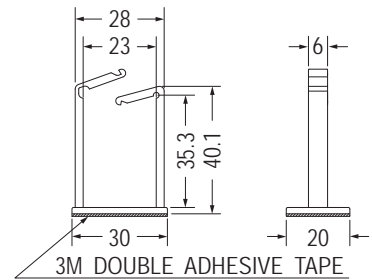

Part No.	Package
WLU-1	200

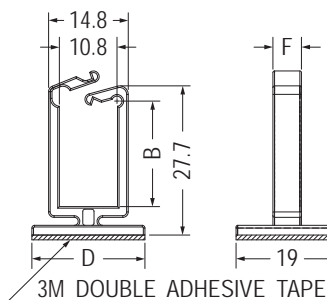

Part No.	B	D	F	Package
WLU-2	19.57	21.0	5.3	200
WLU-3	19.6	16.0	9.3	

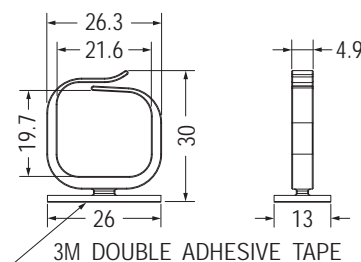

Part No.	Package
WLG-1	250

電線固定座 WIRE SADDLE

用途：超小型，背膠式，可快速固定及解開電線。



- Material: Nylon 66 (UL)
- Flame Class: 94V-2/94V-0
- Color: Natural/Black
- Unit: mm

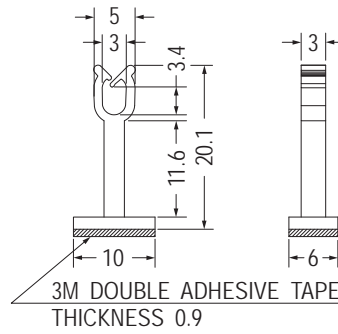

Part No.	Package
WLLD-14	1000

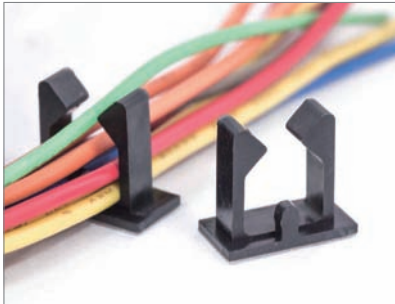

- Material: Nylon 66 (UL)
- Flame Class: 94V-2/94V-0
- Color: Natural/Black
- Unit: mm

用途：背膠式，可快速拆卸，固定電線維修方便，不佔空間。

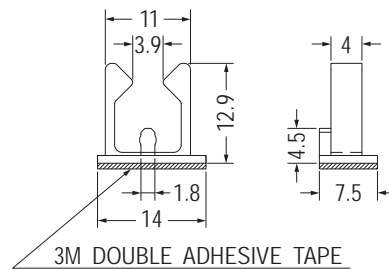

Part No.	Package
WLL-27	1000

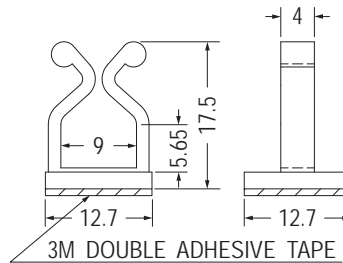

Part No.	Package
MWS-26	1000

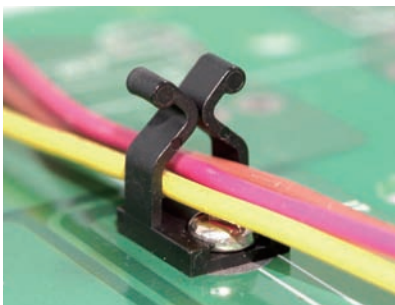

- Material: Nylon 66 (UL)
- Flame Class: 94V-2/94V-0
- Color: Natural/Black
- Unit: mm

用途：使用螺絲固定，可快速拆卸電線，維修方便，不佔空間。

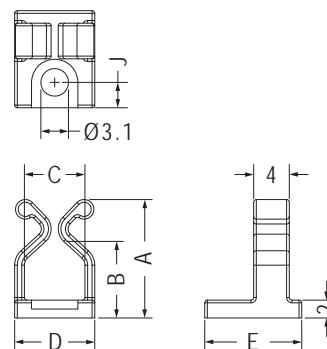

Part No.	A	B	C	D	E	J	Package
WLL-32	17.5	9.1	9.0	12.7	12.7	3.5	1000
WLL-33	13.3	6.6	6.8	9.0	10.9	2.85	

電線固定座 WIRE SADDLE

用途：背膠式，亦可鎖螺絲，可快速拆卸，固定電線，維修方便，不佔空間。

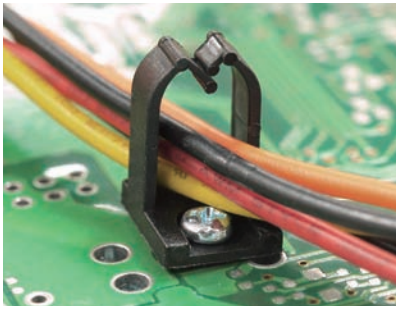

- Material: Nylon 66 (UL)
- Flame Class: 94V-2/94V-0
- Color: Natural/Black
- Unit: mm

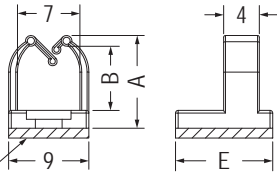
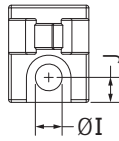

3M DOUBLE ADHESIVE TAPE

Part No.	A	B	E	I	J	Package
WLL-8	10.4	7.2	10.9	3.0	2.8	1000
WLL-11	14.0	10.8	10.9	2.7	2.85	
WLL-12	10.4	7.2	10.9	2.6	2.8	
WLL-26	14.0	9.8	11.0	2.7	2.9	
WLL-28	10.4	7.2	12.4	3.2	3.3	

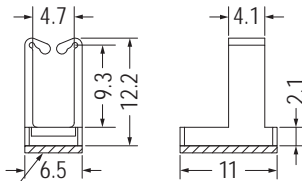
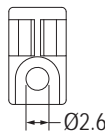

3M DOUBLE ADHESIVE TAPE

Part No.	Package
WLL-29	1000

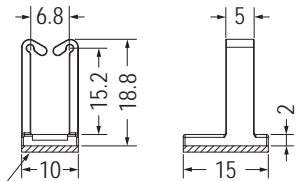
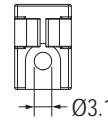

3M DOUBLE ADHESIVE TAPE

Part No.	Package
★WLL-35	1000

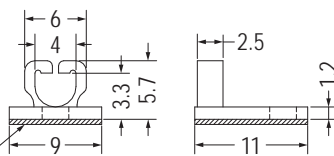
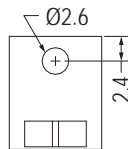
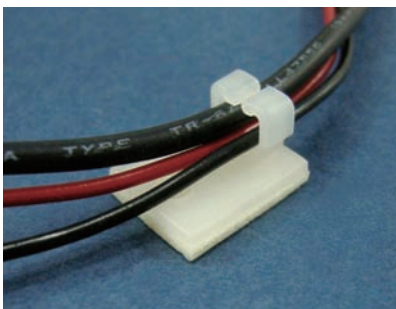

3M DOUBLE ADHESIVE TAPE

Part No.	Package
IMN-1	1000

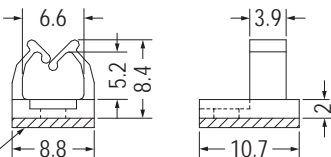
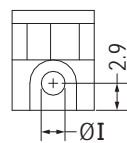
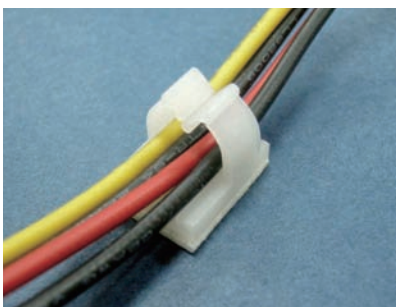

3M DOUBLE ADHESIVE TAPE

Part No.	I	Package
MWS-9	3.0	1000
MWS-9S	1.8	

電線固定座 WIRE SADDLE

用途：使用螺絲固定，可快速拆卸電線，維修方便，不易脫落。

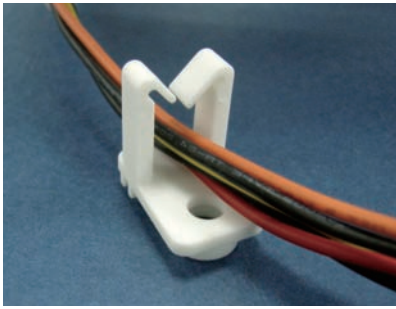

- Material: Nylon 66 (UL)
- Flame Class: 94V-2/94V-0
- Color: Natural/Black
- Unit: mm

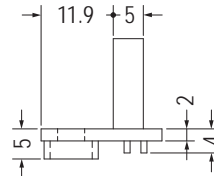
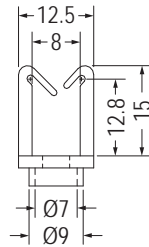
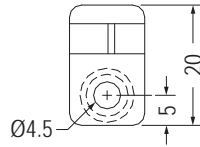

Part No.	Package
CHU-1	100

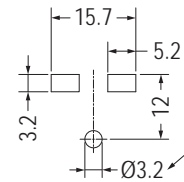
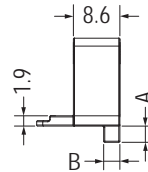
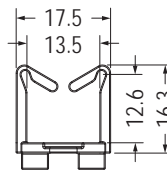
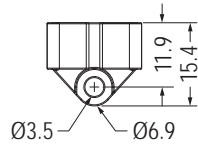

MOUNTING HOLE
【 CHUA-2】

The dimension of mounting hole would depend on customer's screw spec.

孔大小照客戶螺絲增減

Part No.	A	B	Package
CHUA-1	/	/	1000
CHUA-2	3.0	3.0	

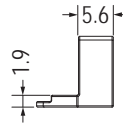
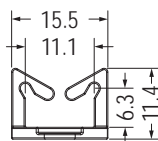
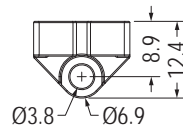

NEW

Part No.	Package
CHUF-1	1000

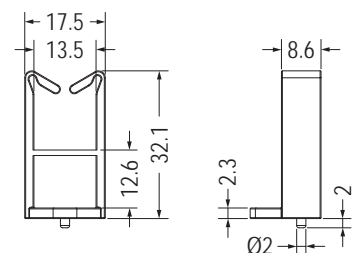
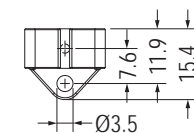
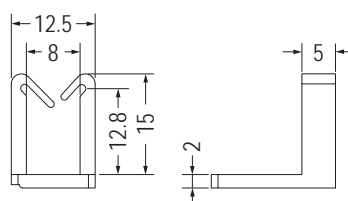
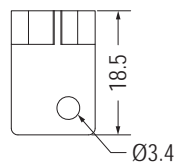
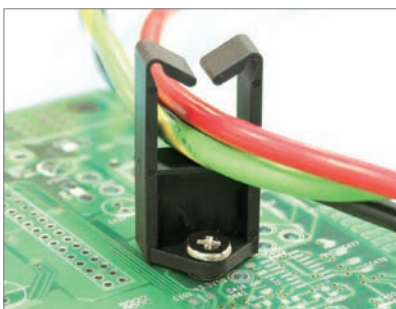

Part No.	Package
CHUB-1	1000

Part No.	Package
CHUC-1	1000

電線固定座 WIRE SADDLE

用途：使用螺絲固定，可快速拆卸電線，維修方便，不易脫落。



- Material: Nylon 66 (UL)
- Flame Class: 94V-2/94V-0
- Color: Natural/Black
- Unit: mm

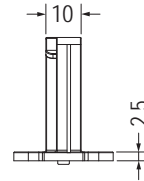
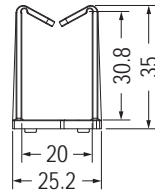
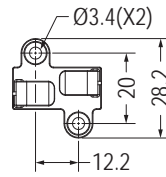

Part No.	Package
CHUL-1	500

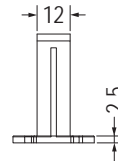
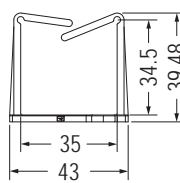
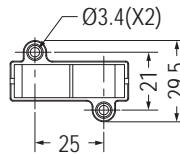

Part No.	Package
CHUL-2	500

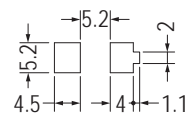
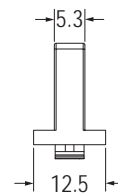
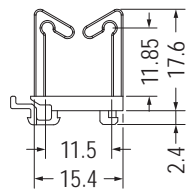

RECOMMEND MOUNTING HOLE THICKNESS 1.0

Part No.	Package
CHWG-1	1000

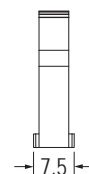
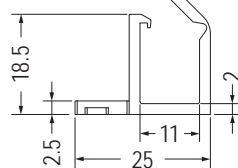
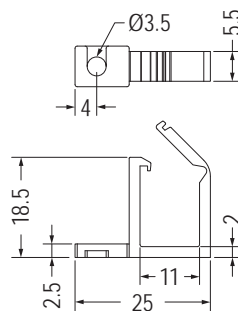
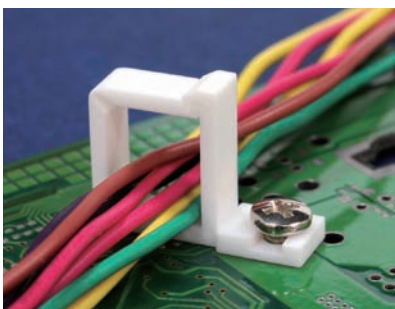

Part No.	Package
CHUE-1	1000

電線固定扣 CABLE CLAMP

用途：配合螺絲，固定電線，整齊美觀。

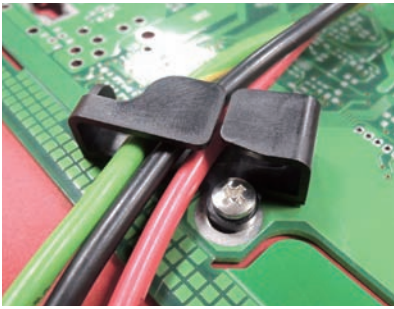

- Material: Nylon 66 (UL)
- Flame Class: 94V-2/94V-0
- Color: Natural/Black
- Unit: mm

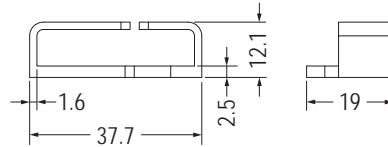
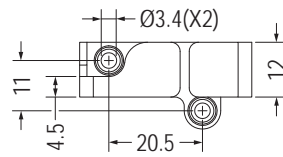

Part No.	Package
CCE-1	1000

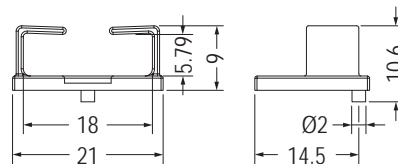
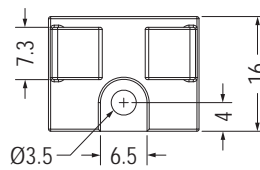
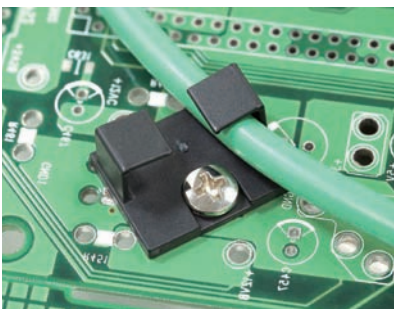

Part No.	Package
WT-11	1000

電線固定座 WIRE SADDLE

用途：背膠式，可快速拆卸，固定電線維修方便，不佔空間。



- Material: Nylon 66 (UL)
- Flame Class: 94V-2/94V-0
- Color: Natural/Black
- Unit: mm

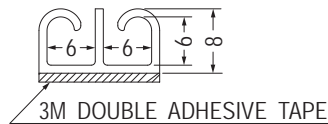
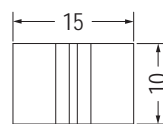

Part No.	Package
WLLT-1	1000

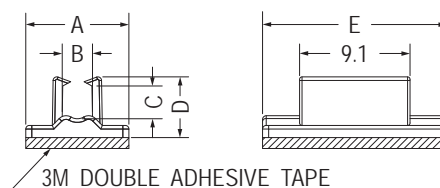
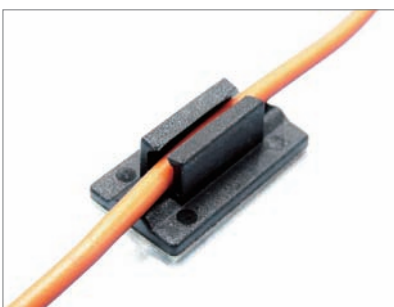

Part No.	A	B	C	D	E	Package
WTC-2	8.5	2.5	2.7	5.0	15.2	500
WTC-3	9.0	3.6	4.0	6.5	16.0	

電線固定座 WIRE MOUNT

用途：背膠式，可快速拆卸，固定電線維修方便，不佔空間。



- Material: ABS
- Color: Black
- Unit: mm

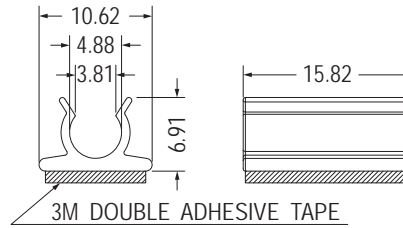

Part No.	Package
THVC-1	500

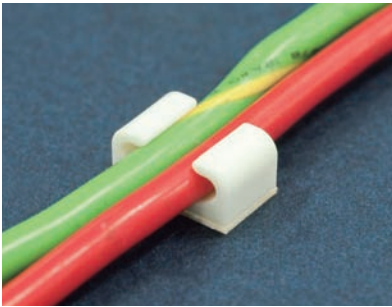

- Material: Nylon 66 (UL)
- Flame Class: 94V-2/94V-0
- Color: Natural/Black
- Unit: mm

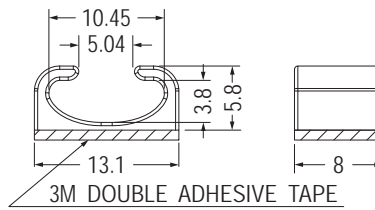

Part No.	Package
WLLT-3	1000

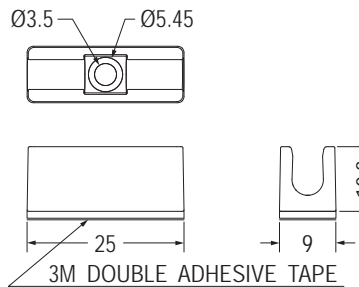
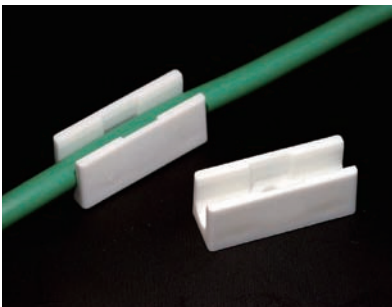

Part No.	Package
WLLT-6	1000

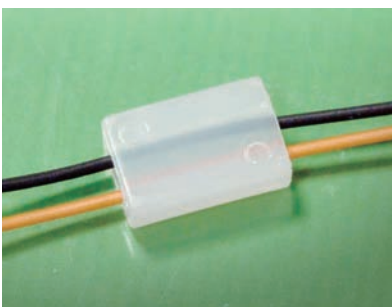

- Material: Nylon 66 (UL)
- Flame Class: 94V-2/94V-0
- Color: Natural/Black
- Unit: mm

用途：背膠式，用於電子、電腦內部電線固定，裝配容易，美觀不脫落。

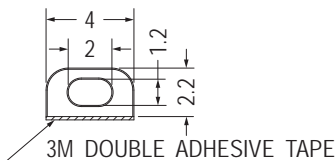
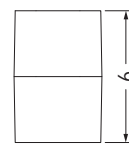

Part No.	Package
MWA-1	1000

電線固定座 CABLE CLAMP

用途：背膠式，可快速拆卸，固定電線維修方便，不佔空間。



- Material: Nylon 66 (UL)
- Flame Class: 94V-2/94V-0
- Color: Natural/Black
- Unit: mm

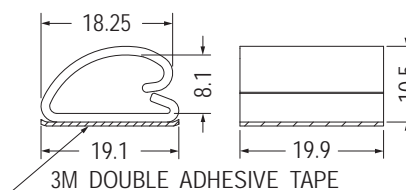

Part No.	Package
WUD-1	1000

電線固定座 MOUNT

用途：固定電線於機板上，維修方便，不佔空間。

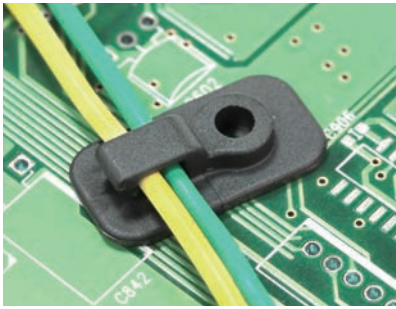

- Material: Nylon 66 (UL)
- Flame Class: 94V-2/94V-0
- Color: Natural/Black
- Unit: mm

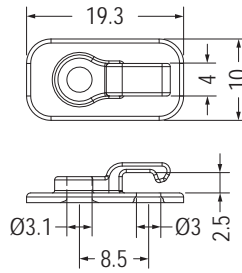

Part No.	Package
MIB-21	1000

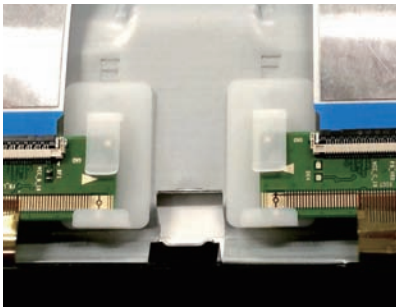

- Material: Nylon 66 (UL)
- Flame Class: 94V-2/94V-0
- Color: Natural/Black
- Unit: mm

用途：背膠式，可快速拆卸，固定電線維修方便，不佔空間。

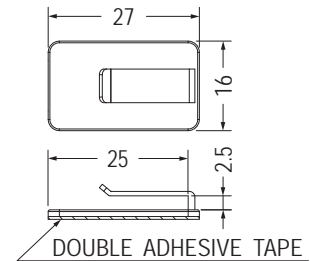
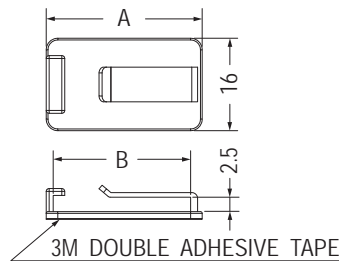

Part No.	A	B	Package
MIB-9	27.0	23.8	1000
MIB-17	31.9	28.7	

Part No.	Package
MIB-10	1000

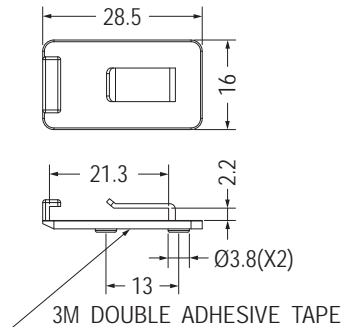
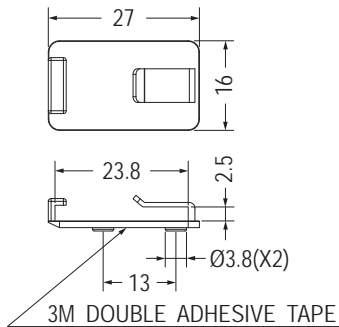
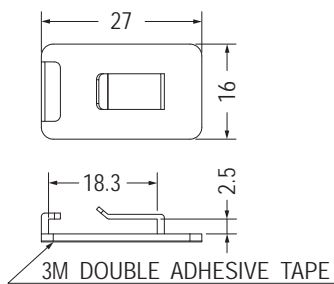

Part No.	Package
MIB-11	1000

Part No.	Package
MIB-33	1000

Part No.	Package
MIB-34	1000

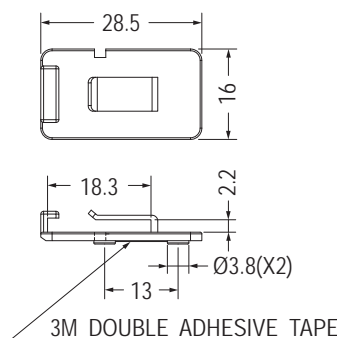

Part No.	Package
MIB-35	1000

電線固定座 MOUNT

用途：固定電線於機板上，維修方便，不佔空間。



- Material: Nylon 66 (UL)
- Flame Class: 94V-2/94V-0
- Color: Natural/Black
- Unit: mm

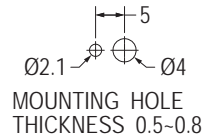
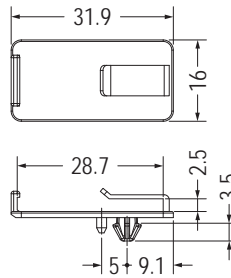

Part No.	Package
MIB-15	1000

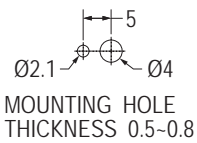
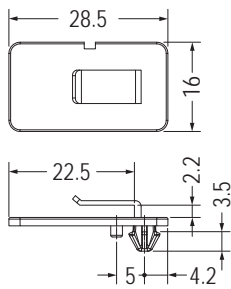

Part No.	Package
MIB-27	1000

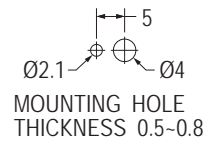
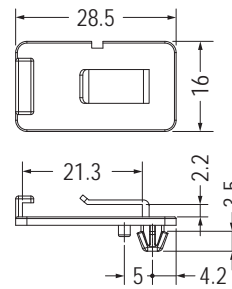

Part No.	Package
MIB-16	1000
MIB-31	

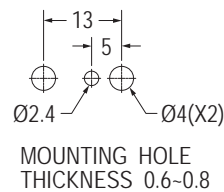
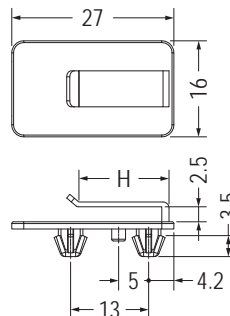
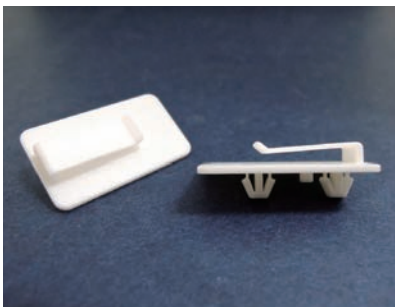

Part No.	H	Package
MIB-3	15.0	1000
MIB-14	8.0	

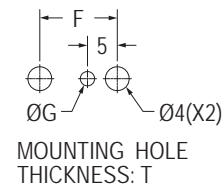
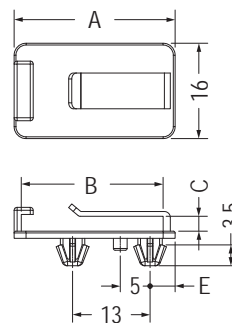

Part No.	A	B	C	E	F	G	T	Package
MIB-1	27.0	23.8	2.5	4.2	13.0	2.4	0.6~0.8	1000
MIB-4	31.9	28.7	2.5	9.1	13.0	2.1	0.5~0.8	
MIB-5	46.2	43.0	2.5	23.4	13.0	2.1	0.5~0.8	500
MIB-7	22.5	19.8	1.5	4.2	12.0	2.1	0.5	1000
MIB-8	28.5	25.25	2.55	4.2	13.0	2.4	0.5	
MIB-12	31.9	28.7	1.7	9.1	13.0	2.1	0.5~0.8	
MIB-13	31.9	28.7	1.4	9.1	13.0	2.1	0.5~0.8	
MIB-25	27.0	23.8	2.5	4.2	13.0	2.2	0.6~0.8	

電線固定座 MOUNT

用途：固定電線於機板上，維修方便，不佔空間。

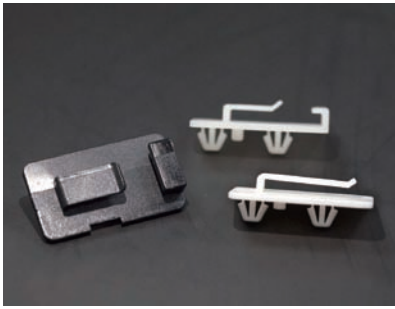

- Material: Nylon 66 (UL)
- Flame Class: 94V-2/94V-0
- Color: Natural/Black
- Unit: mm

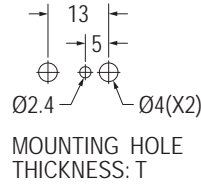
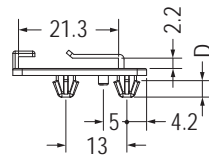
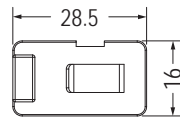

Part No.	D	T	Package
MIB-6	3.5	0.6-0.8	1000
MIB-24	2.7	1.0	
MIB-26	3.5	0.6-0.8	

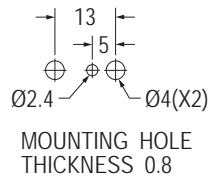
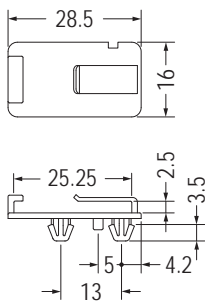

Part No.	Package
MIB-22	1000

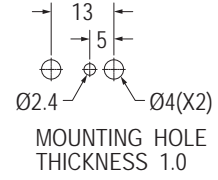
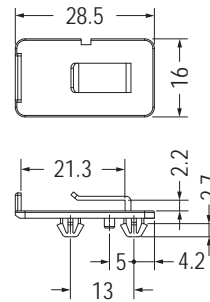

Part No.	Package
MIB-23	1000

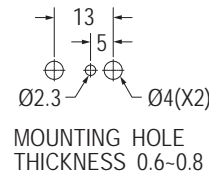
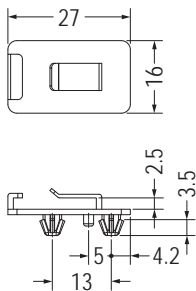

Part No.	Package
MIB-2	1000

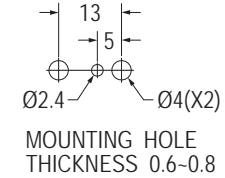
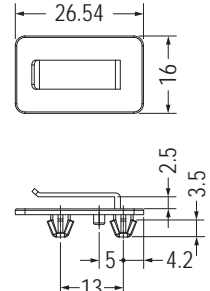

Part No.	Package
MIB-28	1000

電線固定座 WIRE MOUNT

用途：背膠式，可快速拆卸，固定電線維修方便，不佔空間。

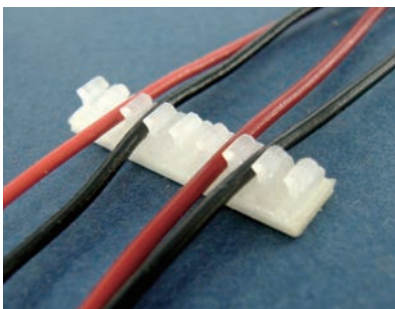

- Material: Nylon 66 (UL)
- Flame Class: 94V-2/94V-0
- Color: Natural/Black
- Unit: mm

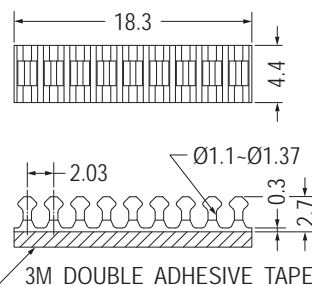

Part No.	Package
MU-01-8	500

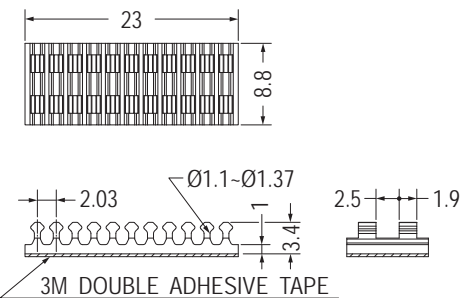

Part No.	Package
MU-02-10	200

電線固定座 WIRE MOUNT

用途：背膠式，可快速拆卸，固定電線維修方便，不佔空間。

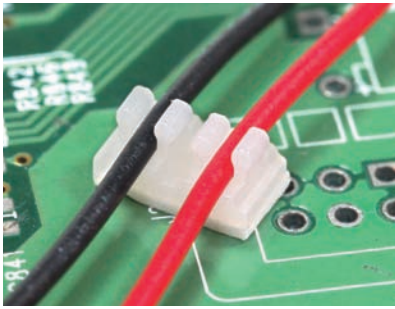

- Material: Nylon 66 (UL)
- Flame Class: 94V-2/94V-0
- Color: Natural/Black
- Unit: mm

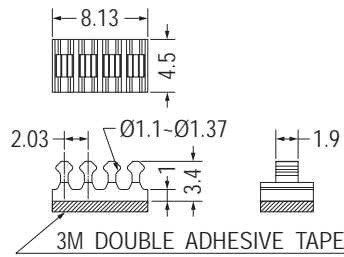

Part No.	Package
MU-03-3	500

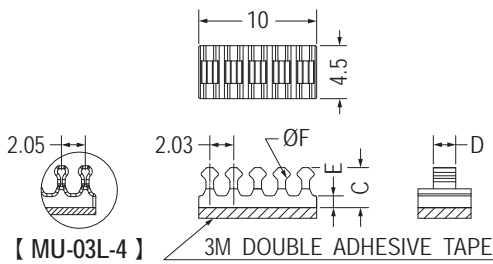

【 MU-03L-4 】

Part No.	C	D	E	F	Package
MU-03-4	3.4	1.9	1.0	1.1~1.37	500
★MU-03L-4	3.6	2.0	1.2	1.4	

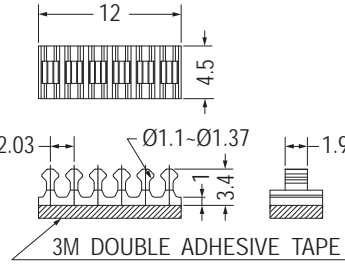

Part No.	Package
MU-03-5	500

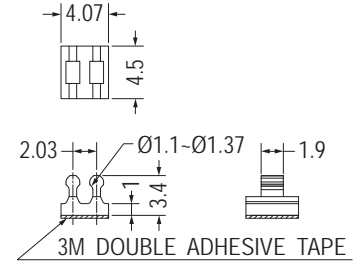

Part No.	Package
MU-05-1	500

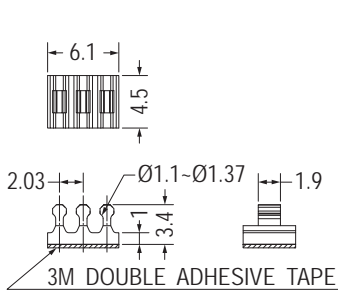

Part No.	Package
MU-05-2	500

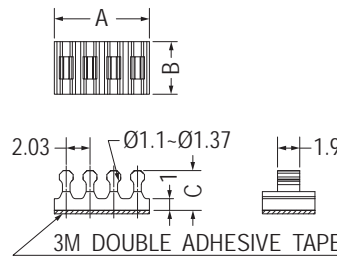

Part No.	A	B	C	Package
MU-05-3	8.13	4.5	3.4	500
MU-08-3	8.1	4.4	3.6	

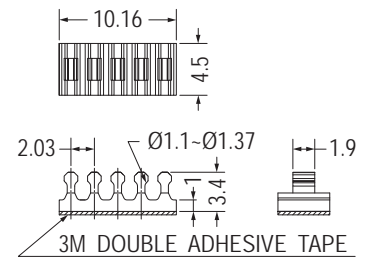

Part No.	Package
MU-05-4	500

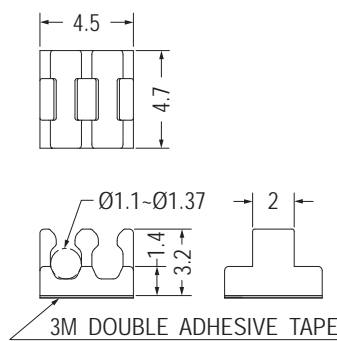
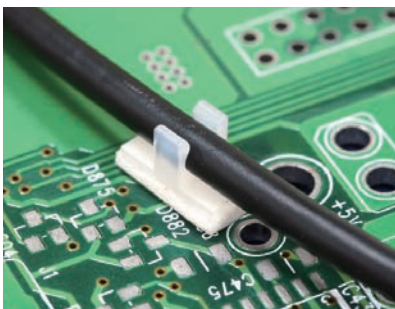

Part No.	Package
MU-07-2	1000

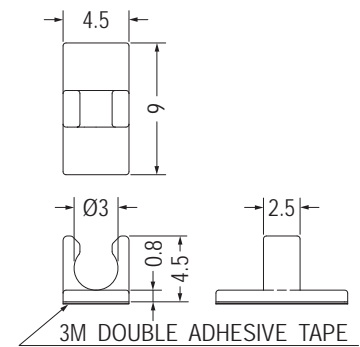

Part No.	Package
MUC-1	1000

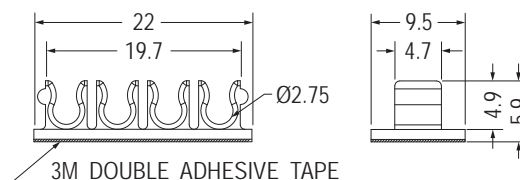

Part No.	Package
MUA-1	500

電線固定座 WIRE MOUNT

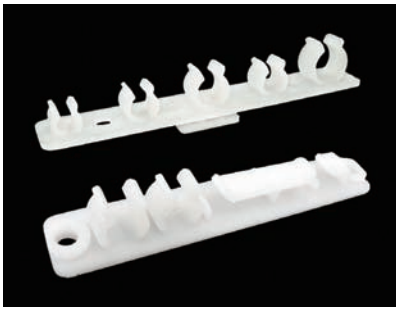

- Material: Nylon 66 (UL)
- Flame Class: 94V-2/94V-0
- Color: Natural/Black
- Unit: mm

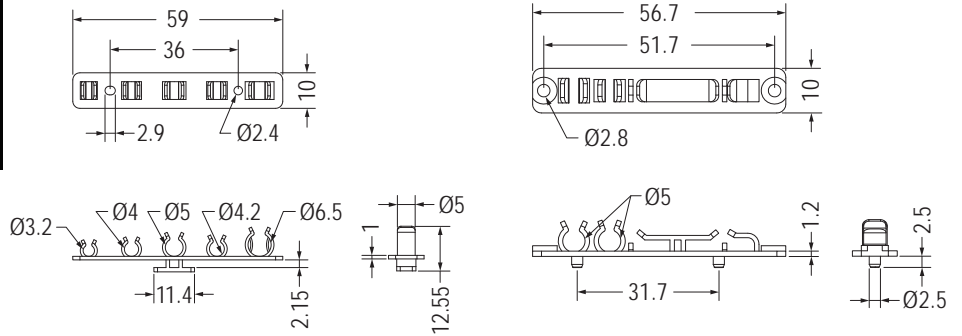

Part No.	Package
JETM-1	100

Part No.	Package
JETM-2	100

用途：固定電線於機板上，維修方便，不佔空間。

插頭固定座 MOUNT

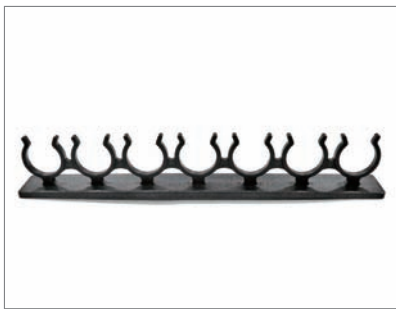

- Material: PP
- Color: Natural/Black
- Unit: mm

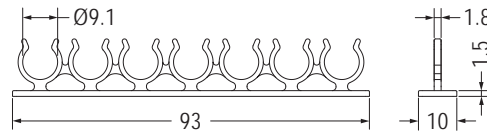

Part No.	Package
JETM-7	100

用途：可快速拆卸，固定插頭。

電線固定座 WIRE MOUNT



- Material: Nylon 66 (UL)
- Flame Class: 94V-2/94V-0
- Color: Natural/Black
- Unit: mm

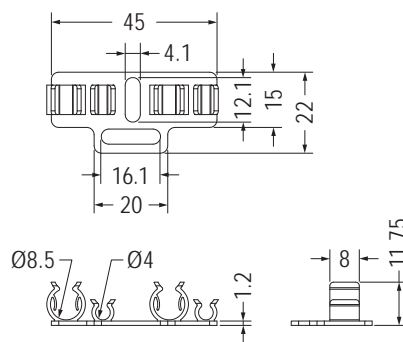

Part No.	Package
CMG-1	500

用途：快速拆卸，固定電線，維修方便，不佔空間。

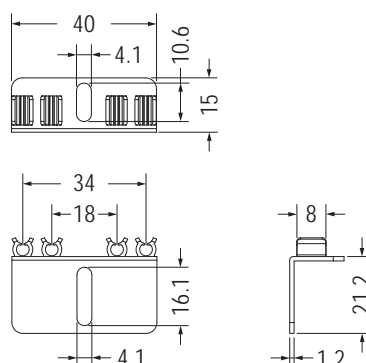

Part No.	Package
CMG-2	500

電線固定座 WIRE MOUNT

用途：固定電線於機殼上。

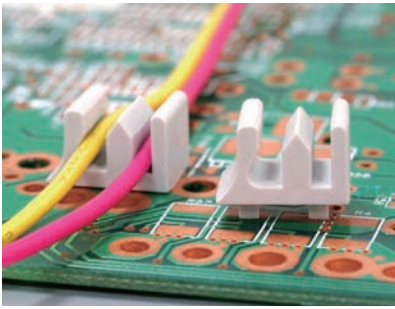

- Material: PC+ABS (UL)
- Flame Class: 94V-2/94V-0
- Color: Gray
- Unit: mm

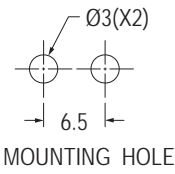
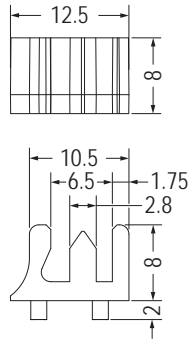

Part No.	Package
CFMG-1	1000



- Material: Nylon 66 (UL)
- Flame Class: 94V-2/94V-0
- Color: Natural/Black
- Unit: mm

用途：固定電線，整齊美觀。

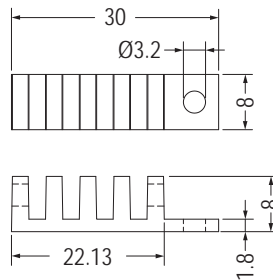

Part No.	Package
AIM25071	1000

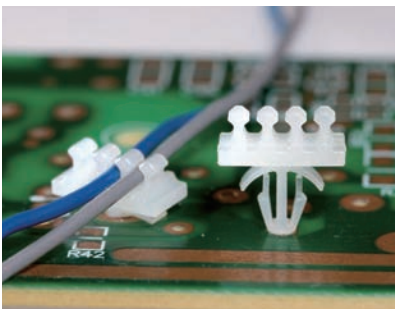

- Material: Nylon 66 (UL)
- Flame Class: 94V-2/94V-0
- Color: Natural/Black
- Unit: mm

用途：可將電線固定於機板上，電線不易磨損，配線整齊美觀。

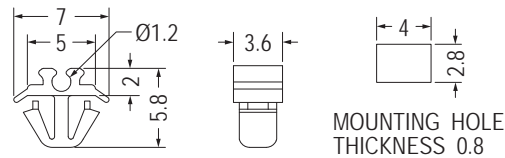

Part No.	Package
MUT-6	1000

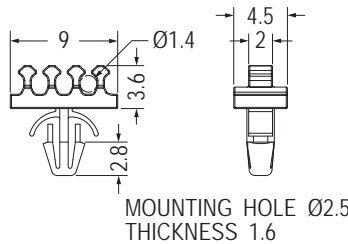
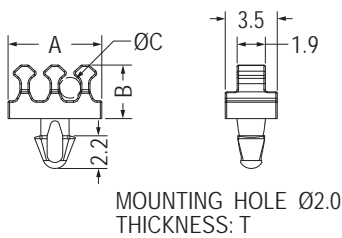

Part No.	Package
MUT-11	1000

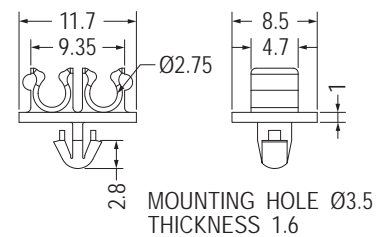

Part No.	Package
MUT-2	1000

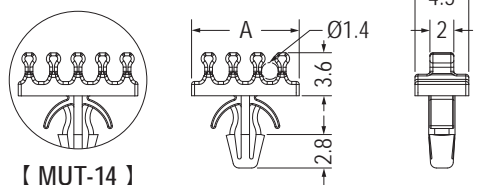
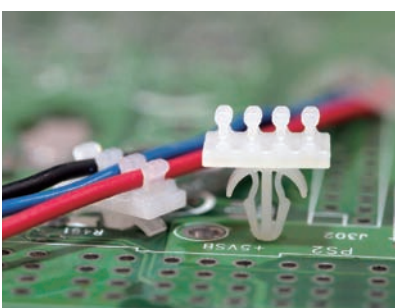

MOUNTING HOLE Ø2.5 THICKNESS 1.6

Part No.	A	Package
MUT-11-1	9.0	1000
★MUT-14	10.0	1000

電線固定座 WIRE MOUNT

用途：可將電線固定於機板上，電線不易磨損，配線整齊美觀。

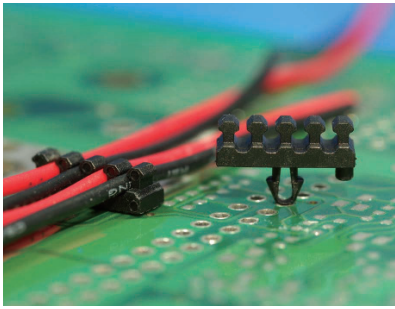

- Material: Nylon 66 (UL)
- Flame Class: 94V-2/94V-0
- Color: Natural/Black
- Unit: mm

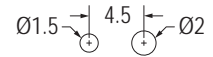
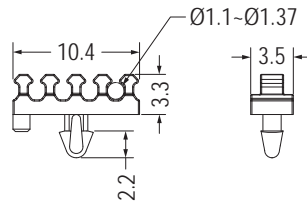

MOUNTING HOLE THICKNESS 1.2

Part No.	Package
MUT-10	1000

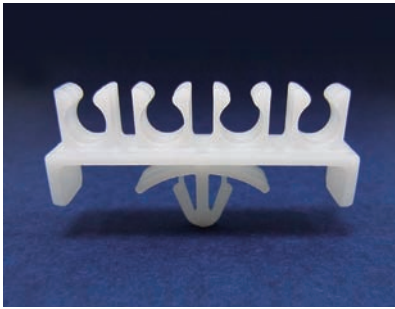

- Material: Nylon 66 (UL)
- Flame Class: 94V-2/94V-0
- Color: Natural/Black
- Unit: mm

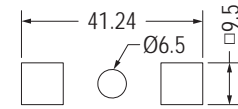
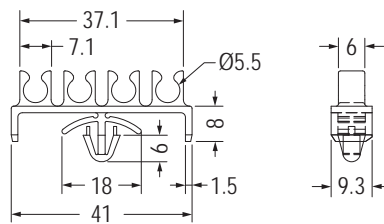

MOUNTING HOLE THICKNESS 1.6-2.5

Part No.	Package
MUT-3	500

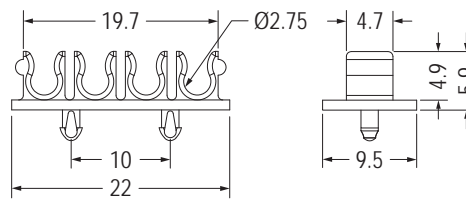
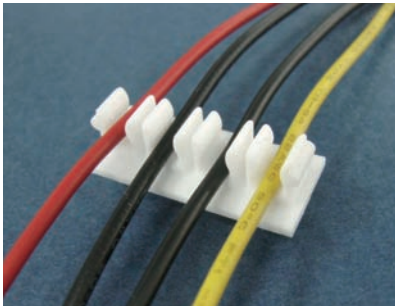

MOUNTING HOLE Ø1.75 THICKNESS 1.6

Part No.	Package
MUT-1	1000

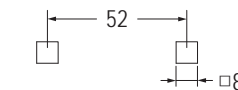
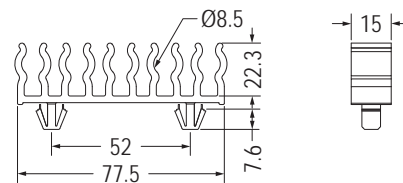

MOUNTING HOLE THICKNESS 1.5-2.0

Part No.	Package
MUT-4	200



- Material: POM
- Color: Natural
- Unit: mm

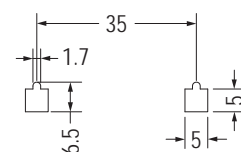
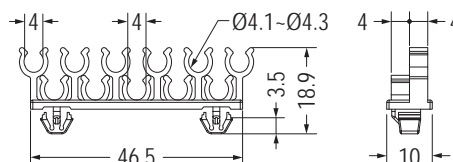

MOUNTING HOLE THICKNESS 1.0-1.5

Part No.	Package
MUT-8	500

天線束線座 WIRE HOLDER

用途：將天線固定於機殼上，電線不易磨損，配線整齊美觀。

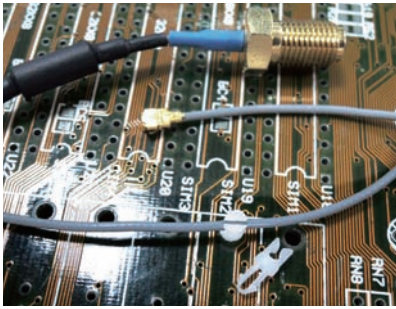

- Material: Nylon 66 (UL)
- Flame Class: 94V-2/94V-0
- Color: Natural/Black
- Unit: mm

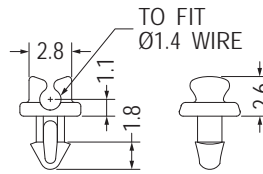

MOUNTING HOLE Ø2.0
THICKNESS 1.6

Part No.	Package
CHBB-1.1	2000

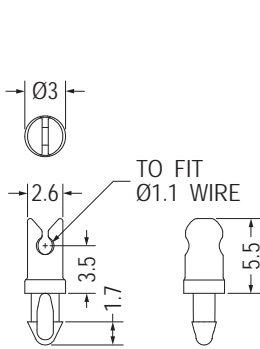

MOUNTING HOLE Ø2.0
THICKNESS 1.6~2.0

Part No.	Package
CHBB-3.5	2000

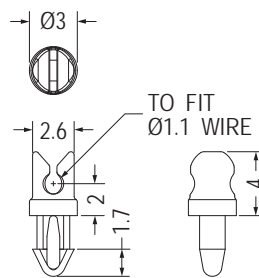

MOUNTING HOLE Ø2.0
THICKNESS: T

Part No.	T	Package
CHBB-2	1.6~2.0	2000
CHBB-2-1	1.0~1.2	
CHBB-2-0.8	0.8	

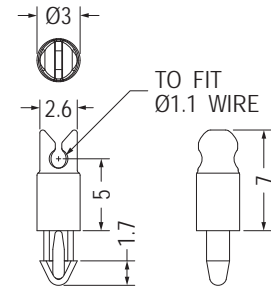

MOUNTING HOLE Ø2.0
THICKNESS: T

Part No.	T	Package
CHBB-5	1.6~2.0	2000
CHBB-5-1	1.0~1.2	
CHBB-5-0.8	0.8	

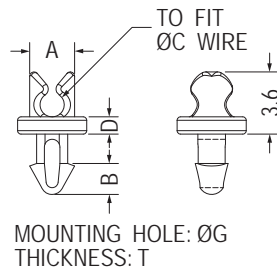

MOUNTING HOLE: ØG
THICKNESS: T

Part No.	A	B	C	D	G	T	Package
CHBB-1.6	2.8	1.7	1.4	0.9	1.8	1.2	2000
CHBB-1.7	2.6	1.8	1.37	1.0	2.0	1.6	

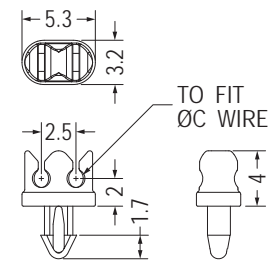

MOUNTING HOLE Ø2.0
THICKNESS: T

Part No.	C	T	Package
CHBB2-2	1.1	1.6~2.0	2000
CHBB2-2-0.8	1.1	0.8	
CHBB2-2-1.2	1.37	1.2	

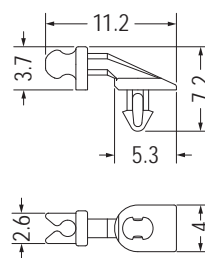

MOUNTING HOLE Ø2.0
THICKNESS 1.6



Part No.	Package
CHBE-1	1000

天線固定座 ANTENNA MOUNT

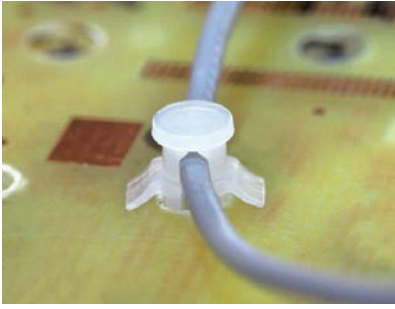

- Material: Nylon 66 (UL)
- Flame Class: 94V-2/94V-0
- Color: Natural/Black
- Unit: mm
- Patented (專利品)

用途：將天線固定於機殼上，電線不易磨損，配線整齊美觀。

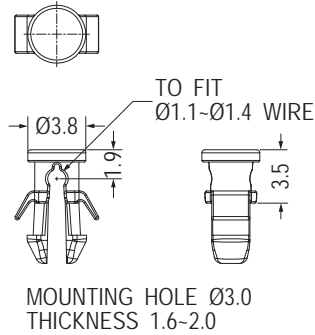

Part No.	Package
CHBD-1	1000



- Material: Nylon 66 (UL)
- Flame Class: 94V-2/94V-0
- Color: Natural/Black
- Unit: mm

用途：用於機頂盒或路由器WI-FI天線之固定。

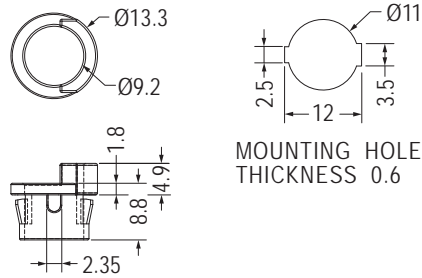

Part No.	Package
ANTCA-1	1000

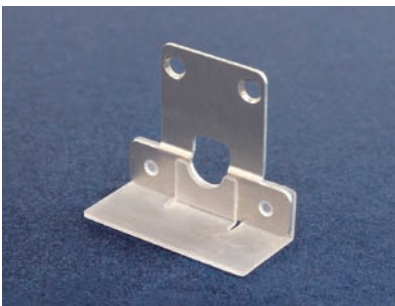

- Material: Nylon 66 (UL)
- Flame Class: 94V-2/94V-0
- Color: Natural/Black
- Unit: mm

用途：用於天線之固定與保護。

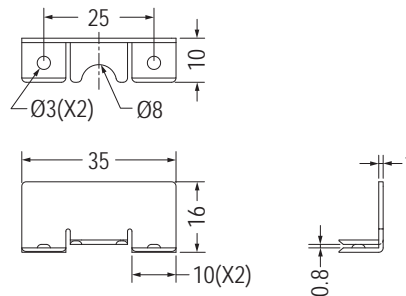

Part No.	Package
ANTCA-2	1000

WI-FI線固定座 WI-FI WIRE MOUNT

用途：用於WI-FI天線固定，避免脫落。

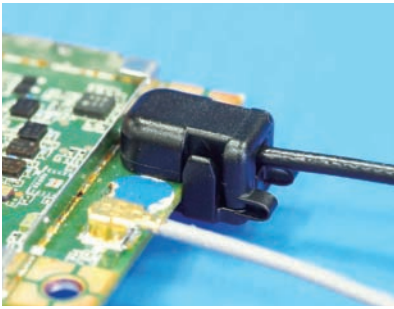

- Material: Nylon 66 (UL)
- Flame Class: 94V-2/94V-0
- Color: Black
- Unit: mm
- Patented (專利品)

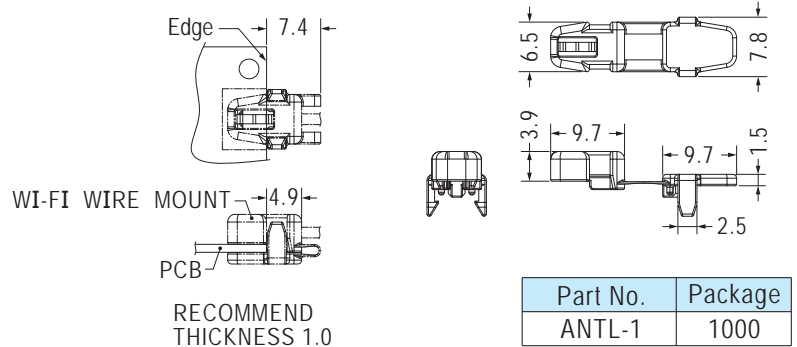

4

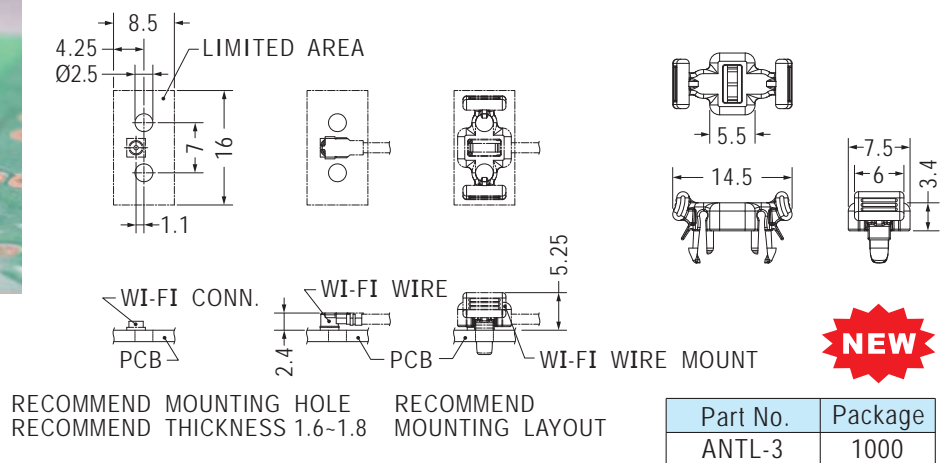
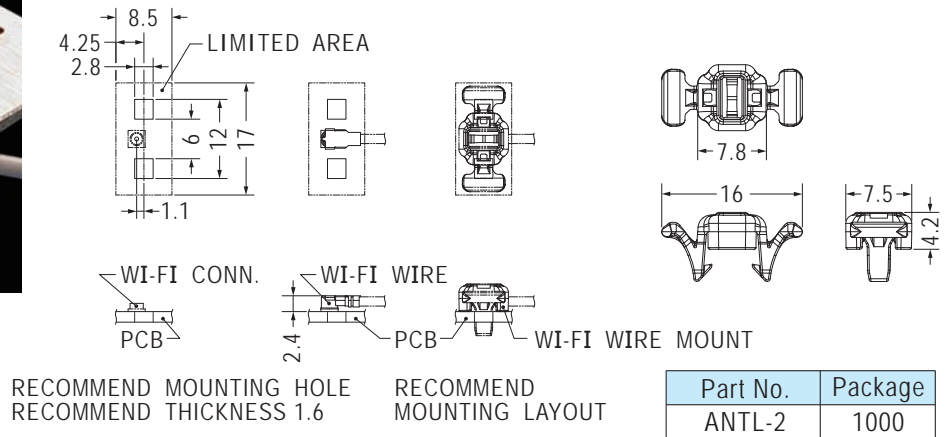
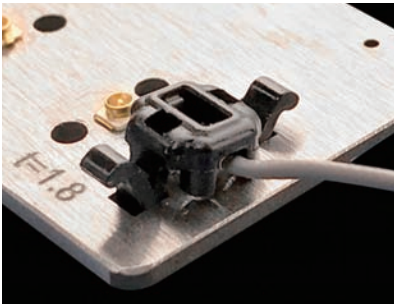

T8固定座 T8 MOUNT

用途：用於輕鋼架之固定網路天線。

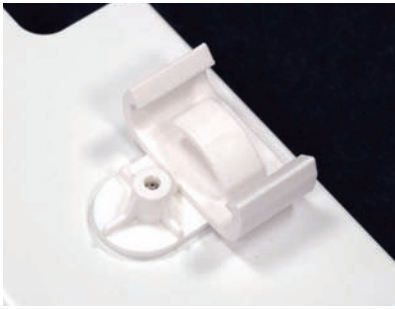

- Material: Nylon 66 (UL)
- Flame Class: 94V-2/94V-0
- Color: Natural/Black
- Unit: mm

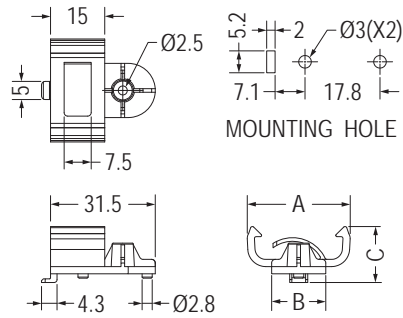

Part No.	A	B	C	Package
EM-550	18.3	8.0	14.1	500
EM-551	28.5	15.0	15.5	
EM-552	42.85	15.0	15.5	250

電線固定座 WIRE CLIP

用途：可背膠或螺絲固定，可快速拆卸電線，維修方便，不佔空間。

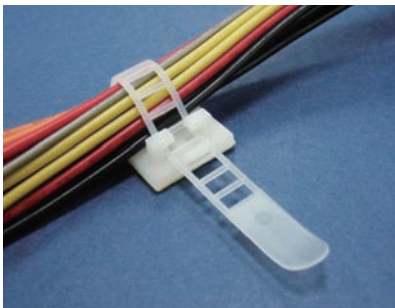

- Material: Nylon 66 (UL)
- Flame Class: 94V-2/94V-0
- Color: Natural/Black
- Unit: mm

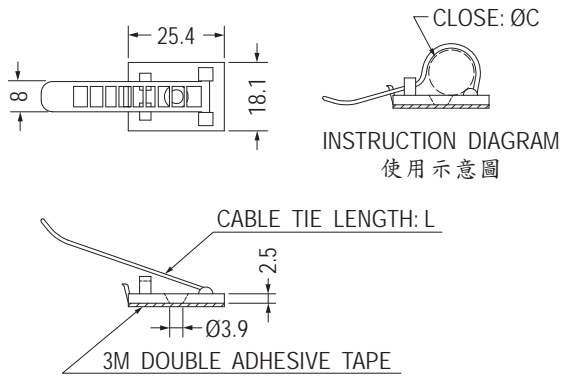

Part No.	C	L	Package
CL-1	14.0	64.2	200
CL-2	22.0	85.0	

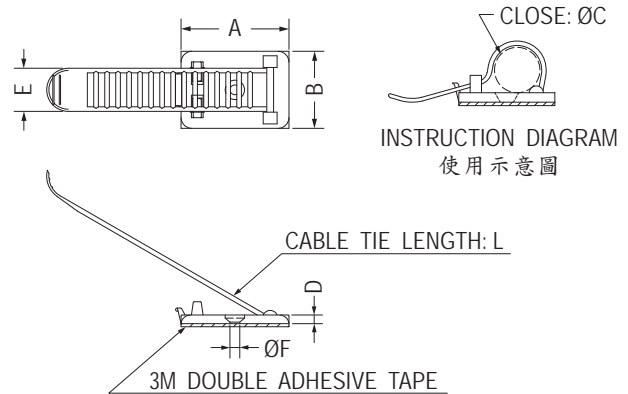

Part No.	A	B	C	D	E	F	L	Package
CL-3	35.0	25.0	22.0	2.8	14.0	3.2	88.3	200
CL-4	35.0	25.0	35.0	2.8	14.0	3.2	127.0	
CL-5	30.2	21.0	22.0	2.5	12.0	3.5	91.0	100
CL-6	30.5	21.0	32.0	2.5	12.0	3.7	117.0	
CL-7	20.0	15.0	12.0	2.5	5.0	3.4	55.0	200
CL-13	25.4	18.0	7.0	2.5	8.0	3.9	35.0	

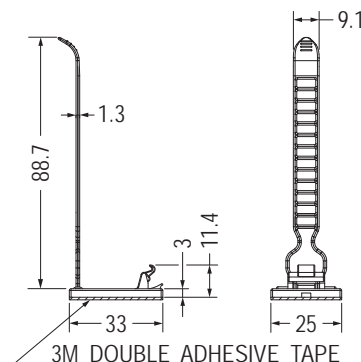

Part No.	Package
CLE-1	200

電線固定座 WIRE CLIP

用途：背膠式，可快速拆卸，固定電線，維修方便，整齊美觀。

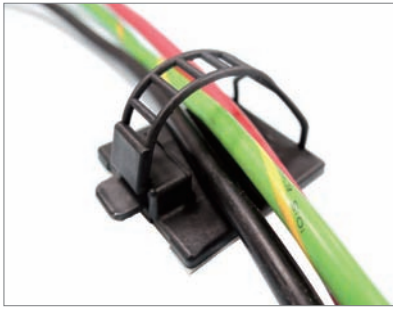

- Material: Nylon 66 (UL)
- Flame Class: 94V-2/94V-0
- Color: Natural/Black
- Unit: mm

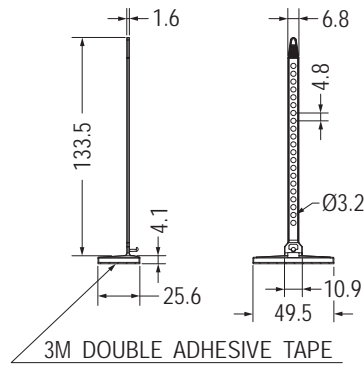

Part No.	Package
CLB-1	200

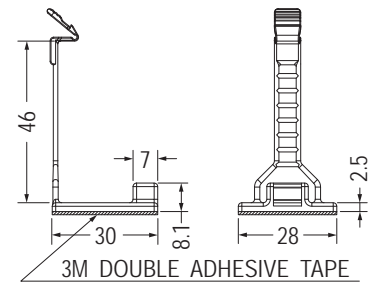

• Patented (專利品)

Part No.	Package
CLE-3	200

4



- Material: Nylon 66 (UL)
- Flame Class: 94V-2/94V-0
- Color: Natural/Black
- Unit: mm

用途：固定電線於機板上，維修方便，不佔空間。

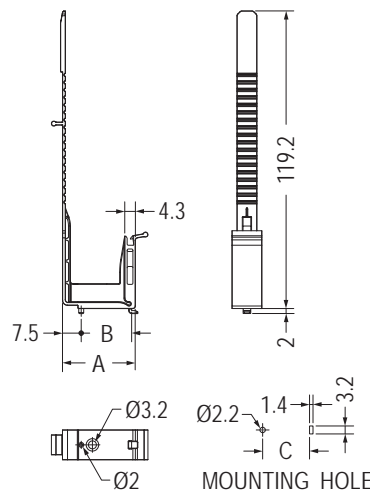

Part No.	A	B	C	Package
CLF-2	29.2	20.2	18.9	100
CLF-3	24.2	15.2	13.9	

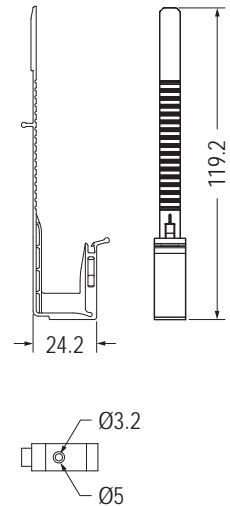

Part No.	Package
CLF-4	100



- Material: Nylon 66 (UL)
- Flame Class: 94V-2/94V-0
- Color: Natural/Black
- Unit: mm

用途：配合螺絲，固定電線，整齊美觀。

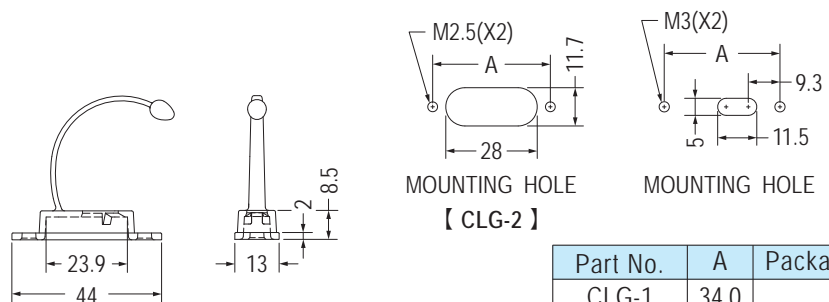

Part No.	A	Package
CLG-1	34.0	200
CLG-2	36.0	

電線固定座 WIRE SADDLE

用途：卡槽式，可快速捆紮及解開電線。

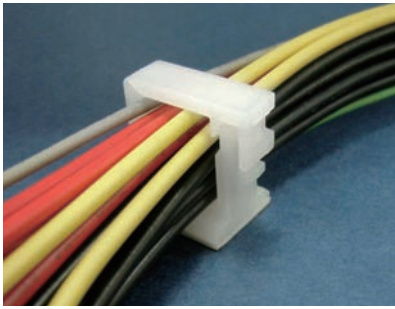

- Material: Nylon 66 (UL)
- Flame Class: 94V-2/94V-0
- Color: Natural/Black
- Unit: mm

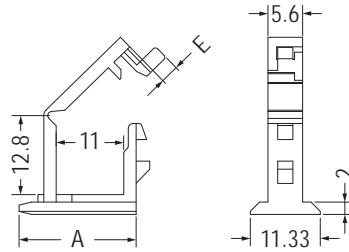

Part No.	A	E	Package
WLF-1	19.05		500
WLF-2	18.95	3.0	



【 WLF-5 】

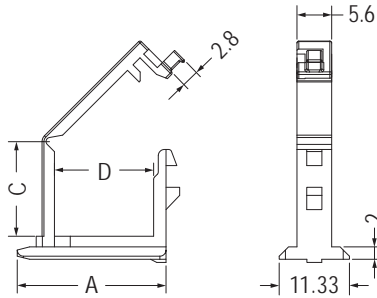

Part No.	A	C	D	Package
WLF-3	24.05	15.3	16.0	500
WLF-4	19.05	12.8	11.05	
WLF-5	19.05	12.8	11.05	

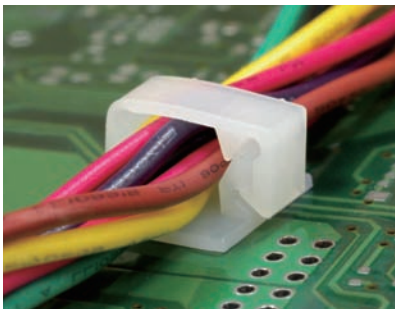

- Material: Nylon 66 (UL)
- Flame Class: 94V-2/94V-0
- Color: Natural/Black
- Unit: mm

用途：背膠式，可快速捆紮及解開電線。

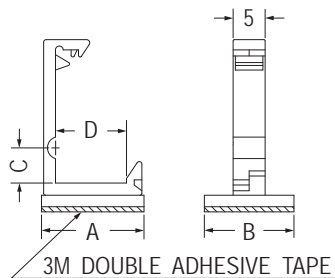

Part No.	A	B	C	D	Package
WLN-1S	16.0	14.0	5.5	11.1	500
WLN-6	13.0	12.0	6.0	8.1	

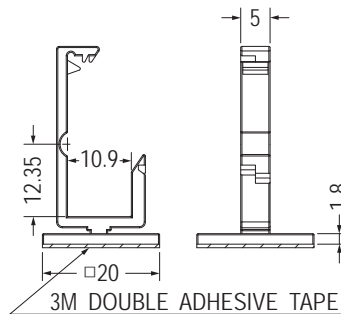
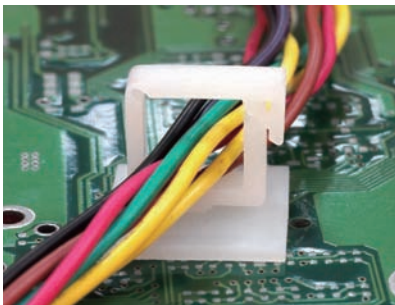

Part No.	Package
WLM-1	500

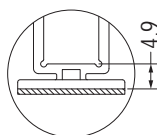

【 WLN-8 】

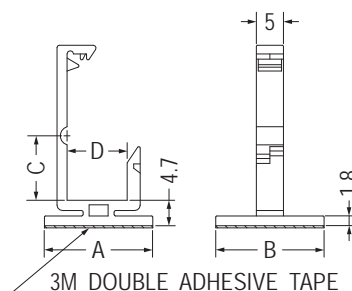

Part No.	A	B	C	D	Package
WLN-1	20.0	20.0	6.7	11.1	500
WLN-2	20.0	20.0	11.9	11.1	
WLN-3	20.0	20.0	15.7	15.7	250
WLN-5	15.0	14.0	8.7	10.75	500
WLN-7	16.0	12.0	8.7	10.75	
★WLN-8	21.0	19.0	20.8	10.8	

電線固定座 WIRE SADDLE

用途：可用背膠式或螺絲固定，可快速捆紮及解開電線。

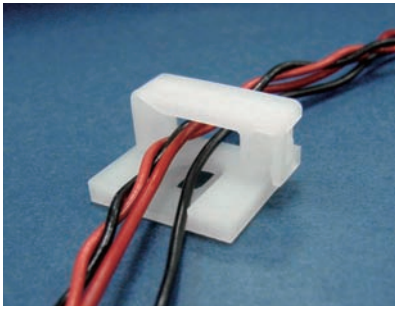

- Material: Nylon 66 (UL)
- Flame Class: 94V-2/94V-0
- Color: Natural/Black
- Unit: mm

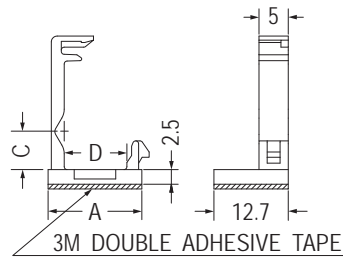

Part No.	A	C	D	Package
WLT-1	16.0	6.5	10.7	500
WLT-2	21.6	11.7	16.3	

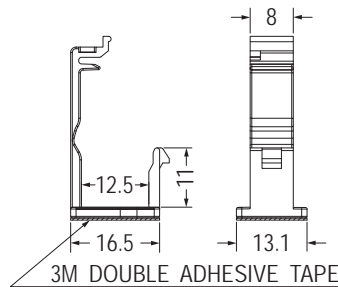
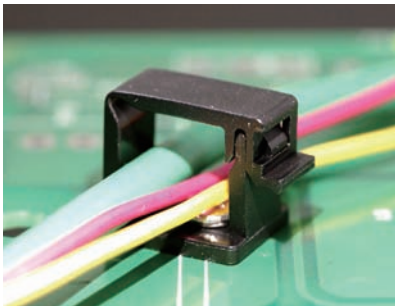

Part No.	Package
WLB-1	500



- Material: Nylon 66 (UL)
- Flame Class: 94V-2/94V-0
- Color: Natural/Black
- Unit: mm

用途：背膠式，可快速捆紮及解開電線。

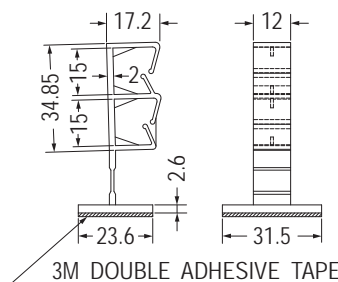

Part No.	Package
W2LK-1	50

電線固定座 WIRE SADDLE

用途：固定電線於PC板或機板上，維修方便，不佔空間。

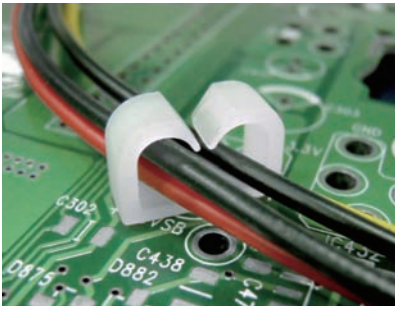

- Material: Nylon 66 (UL)
- Flame Class: 94V-2/94V-0
- Color: Natural/Black
- Unit: mm

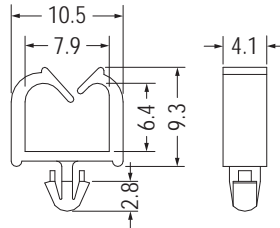

MOUNTING HOLE Ø3.0
THICKNESS 0.8-1.6

Part No.	Package
MWS-12	1000

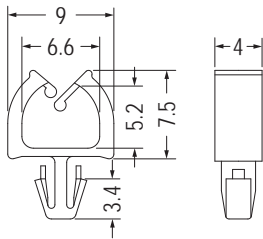

MOUNTING HOLE Ø3.0
THICKNESS 1.6

Part No.	Package
MWS-10	1000

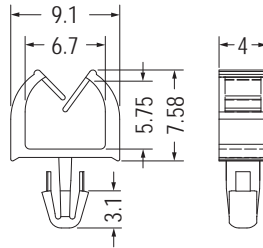

MOUNTING HOLE Ø3.0
THICKNESS 2.4

Part No.	Package
MWS-53	1000

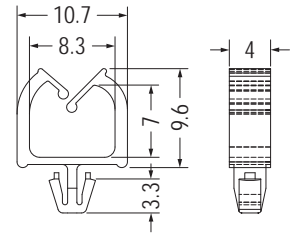

MOUNTING HOLE Ø3.3
THICKNESS 1.0

Part No.	Package
MWS-31	1000

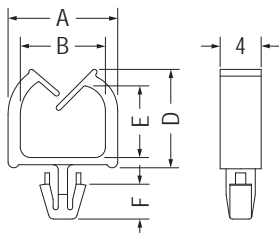

MOUNTING HOLE: ØG
THICKNESS: T

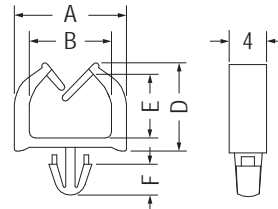

MOUNTING HOLE: ØG
THICKNESS 1.0-1.6

E217732
UL 1565

Part No.	A	B	D	E	F	G	T	Package
MWS-11	9.0	6.6	7.65	5.15	3.2	3.5	1.6	1000
MWS-11S	9.0	6.6	7.65	5.15	2.8	3.5	1.0	
MWS-15	10.7	8.3	9.6	7.0	3.4	3.0	1.6	
MWS-15S	10.7	8.3	9.6	7.0	2.4	3.0	1.6	

Part No.	A	B	D	E	F	G	Package	UL
MWS-6	12.0	8.8	11.0	8.5	2.8	3.5	1000	UL
MWS-7	9.2	6.8	7.6	5.0	2.7	3.0	2000	UL
MWS-41	12.0	9.0	11.5	8.48	2.8	3.5	1000	

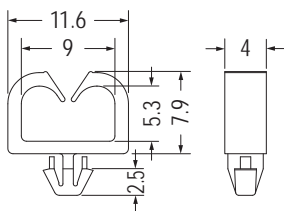

MOUNTING HOLE Ø3.5
THICKNESS 0.8-1.2

Part No.	Package
MWS-19	1000

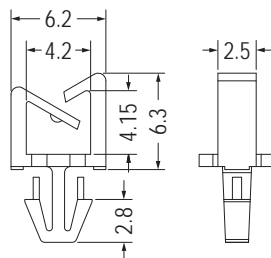

MOUNTING HOLE Ø3.0
THICKNESS 1.6

Part No.	Package
MWS-58	1000

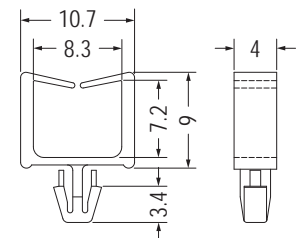

MOUNTING HOLE Ø3.0
THICKNESS 1.6

Part No.	Package
MWS-38	1000

電線固定座 WIRE SADDLE

用途：固定電線於PC板或機板上，維修方便，不佔空間。

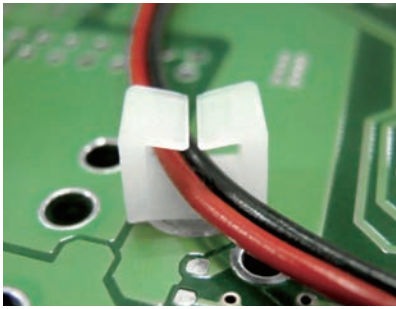

- Material: Nylon 66 (UL)
- Flame Class: 94V-2/94V-0
- Color: Natural/Black
- Unit: mm

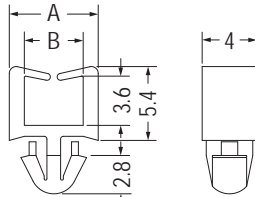

MOUNTING HOLE Ø3.5
THICKNESS: T

Part No.	A	B	T	Package
MWS-13	6.5	4.3	1.0	1000
MWS-13L	7.8	5.6	1.5	
MWS-14	6.5	4.3	4.0	

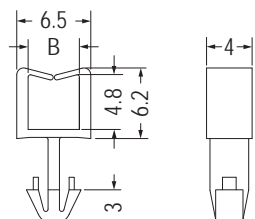
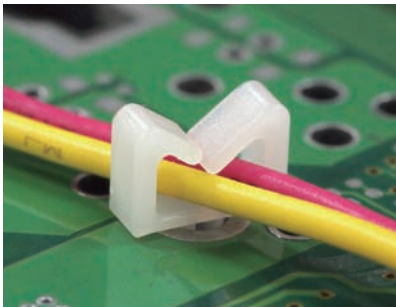

MOUNTING HOLE Ø3.5
THICKNESS: T

Part No.	B	T	Package
MWS-20	4.5	4.0	1000
MWS-25	4.3	2.5	

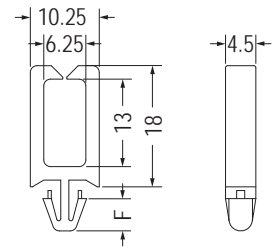

MOUNTING HOLE: ØG
THICKNESS: T

Part No.	F	G	T	Package
CHY-1	4.8	4.8	1.8	1000
CHY-1S	2.5	3.0	1.6	

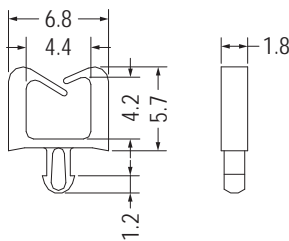

MOUNTING HOLE Ø1.75
THICKNESS 1.6

Part No.	Package
MWS-16	2000

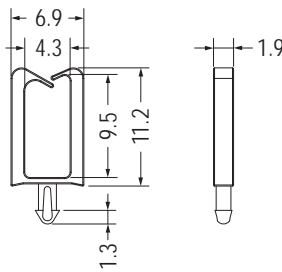

MOUNTING HOLE Ø1.75
THICKNESS 2.2

Part No.	Package
MWS-55	2000

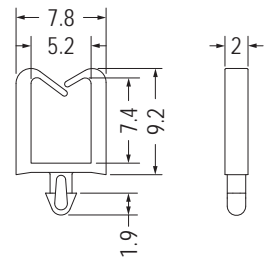

MOUNTING HOLE Ø2.0
THICKNESS: T

Part No.	T	Package
MWS-59	1.6	2000
MWS-59S	0.8	
MWS-59L	2.0	

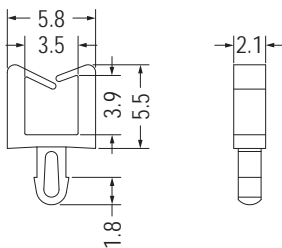

MOUNTING HOLE Ø2.0
THICKNESS: T

Part No.	T	Package
MWS-8	1.6~1.8	2000
★MWS-8S	1.2	

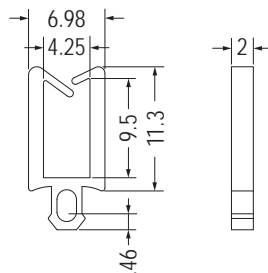

MOUNTING HOLE Ø2.8
THICKNESS 2.0

Part No.	Package
MWS-24	2000

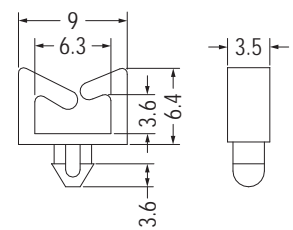

MOUNTING HOLE Ø3.0
THICKNESS 1.2-1.6

Part No.	Package
MWS-1	2000

電線固定座 WIRE SADDLE

用途：固定電線於PC板或機板上，維修方便，不佔空間。

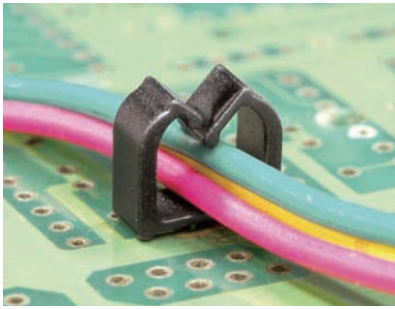

- Material: Nylon 66 (UL)
- Flame Class: 94V-2/94V-0
- Color: Natural/Black
- Unit: mm

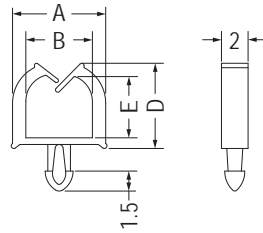

MOUNTING HOLE Ø1.75
THICKNESS 1.6

Part No.	A	B	D	E	Package
MWS-17	7.0	5.0	6.4	4.6	2000
MWS-44	8.5	6.5	7.0	5.2	

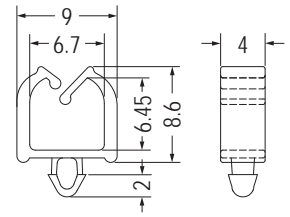

MOUNTING HOLE Ø3.0
THICKNESS 1.1

Part No.	Package
MWS-50	200

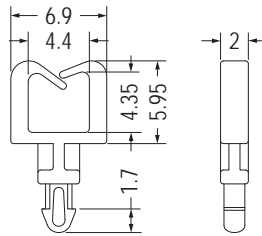
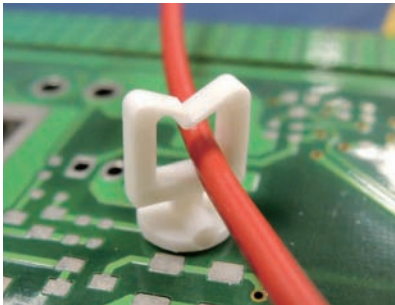

MOUNTING HOLE Ø2.0
THICKNESS 1.6

Part No.	Package
MWS-47	1000

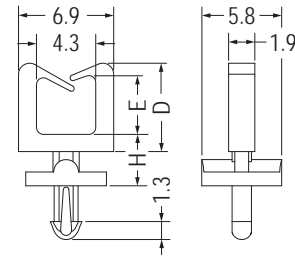

MOUNTING HOLE: ØG
THICKNESS: T

Part No.	D	E	G	H	T	Package
MWSD-3	6.4	4.26	1.8-1.9	3.73	2.4	1000
MWSD-4	7.3	5.1	1.78	6.4	1.57	

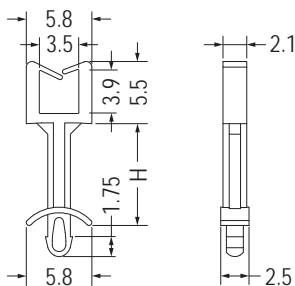

MOUNTING HOLE Ø2.0
THICKNESS 1.6-1.8

Part No.	H	Package
MWSE-1	9.0	1000
MWSE-2	7.0	
MWSE-4	15.0	

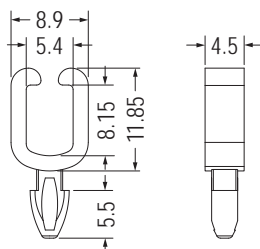

MOUNTING HOLE Ø4.0
THICKNESS 2.2

Part No.	Package
MWS-28	2000

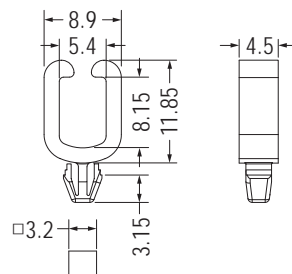

MOUNTING HOLE
THICKNESS 0.6-1.2

Part No.	Package
MWS-40	2000

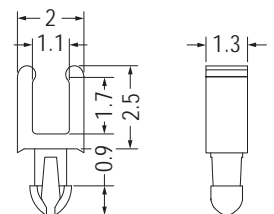

MOUNTING HOLE Ø1.0
THICKNESS 1.0

Part No.	Package
MWSC-7	1000

電線束線座 WIRE HOLDER



- Material: Nylon 66 (UL)
- Flame Class: 94V-2/94V-0
- Color: Natural/Black
- Unit: mm

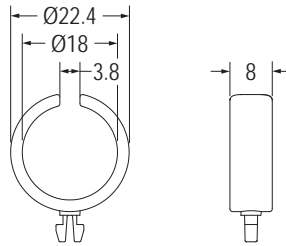

MOUNTING HOLE $\varnothing 4.0$
THICKNESS 2.5

Part No.	Package
THCC-1	500

用途：固定電線於機板上，維修方便，不佔空間。

電線固定座 WIRE SADDLE

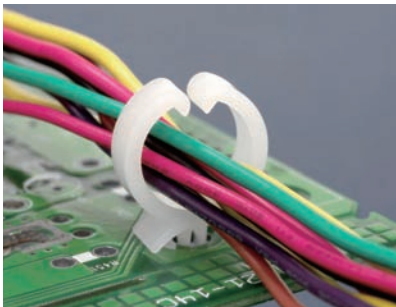

- Material: Nylon 6 (UL)
- Flame Class: 94V-2
- Color: Natural
- Unit: mm

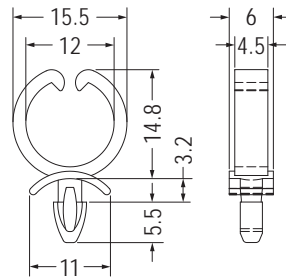

MOUNTING HOLE: $\varnothing G$
THICKNESS 0.8-2.2

Part No.	G	Package
CHBA-1	3.5	1000
CHBA-2	3.2	

用途：固定電線於PC板或機板上，維修方便，不佔空間。

4



- Material: Nylon 66 (UL)
- Flame Class: 94V-2/94V-0
- Color: Natural/Black
- Unit: mm

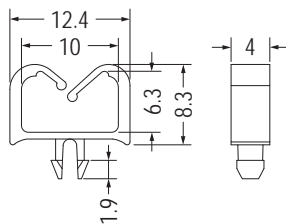

MOUNTING HOLE $\varnothing 3.0$
THICKNESS: T

Part No.	T	Package
MWSC-2	1.5	1000
MWSC-2L	2.0	

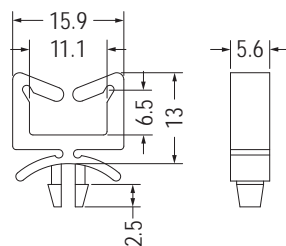
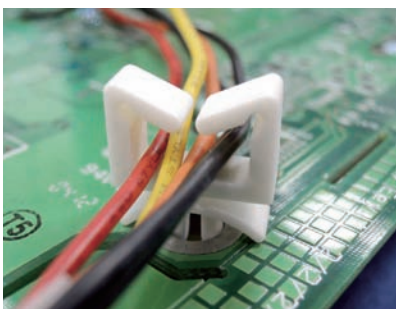

MOUNTING HOLE: $\varnothing G$
THICKNESS 0.8-1.6

Part No.	G	Package
CHAE-1	4.8	1000
CHAE-1S	4.4	

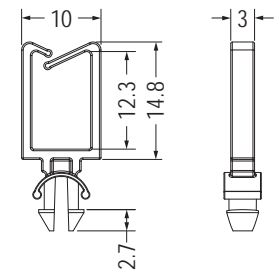

MOUNTING HOLE $\varnothing 4.4$
THICKNESS 2.0-3.0

Part No.	Package
CHAV-1	1000

電線固定座 WIRE SADDLE

用途：固定電線於PC板或機板上，維修方便，不佔空間。

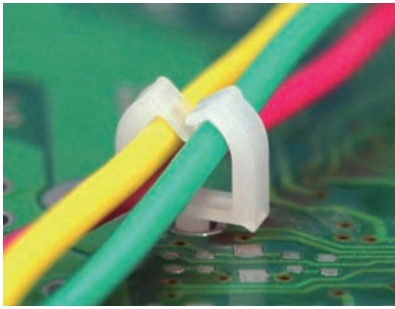

- Material: Nylon 66 (UL)
- Flame Class: 94V-2/94V-0
- Color: Natural/Black
- Unit: mm

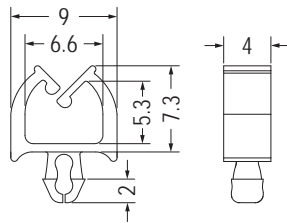

MOUNTING HOLE Ø3.0
THICKNESS 1.2-1.6

Part No.	Package
MWSC-1	1000

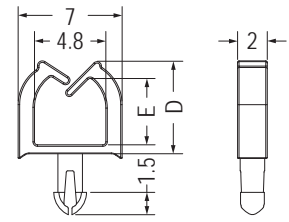

MOUNTING HOLE Ø1.7
THICKNESS: T

Part No.	D	E	T	Package
MWSC-3	6.3	4.46	2.4	1000
MWSC-4	4.0	2.2	2.4	
MWSC-5	4.0	2.2	1.6	
MWSC-6	6.0	4.2	1.6	

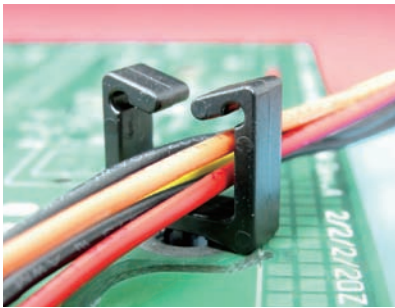

- Material: PC+ABS (UL)
- Flame Class: 94V-2/94V-0
- Color: Natural/Black
- Unit: mm

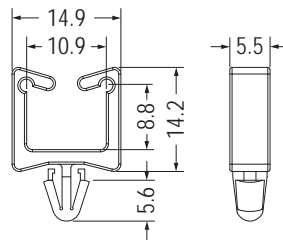

MOUNTING HOLE Ø4.8
THICKNESS 1.1

Part No.	Package
CHAW-1	1000

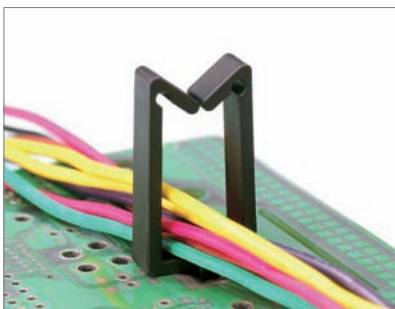

- Material: Nylon 66 (UL)
- Flame Class: 94V-2/94V-0
- Color: Natural/Black
- Unit: mm

用途：可快速固定電線，安裝容易。

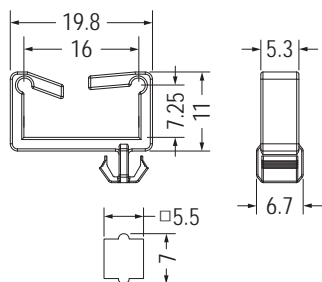

MOUNTING HOLE
THICKNESS 1.6

Part No.	Package
CHAB-5	1000

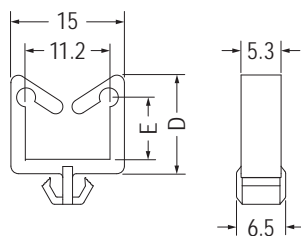

MOUNTING HOLE
THICKNESS 1.0

Part No.	D	E	Package
CHAB-1	12.0	7.2	1000
CHAB-2	17.0	12.2	500
CHAB-3	26.0	21.2	

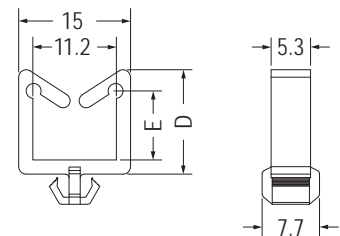

MOUNTING HOLE
THICKNESS 0.5-0.8

【 CHAB-4 】

Part No.	D	E	Package
CHAB-1L	12.0	7.2	1000
CHAB-4	14.0	9.3	

【 CHAB-1L 】

電線固定座 WIRE SADDLE

用途：固定電線於PC板或機板上，維修方便，不佔空間。

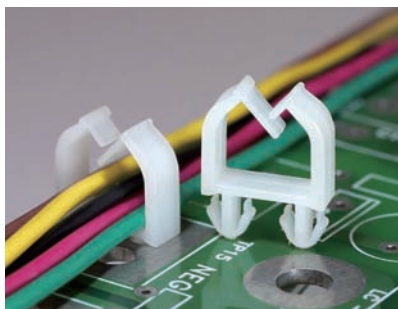

- Material: Nylon 66 (UL)
- Flame Class: 94V-2/94V-0
- Color: Natural/Black
- Unit: mm

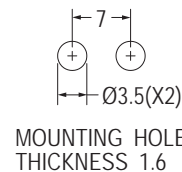
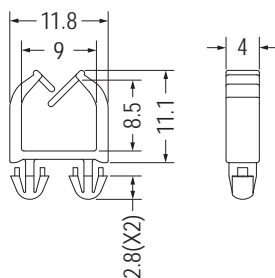

Part No.	Package
MWSG-1	1000

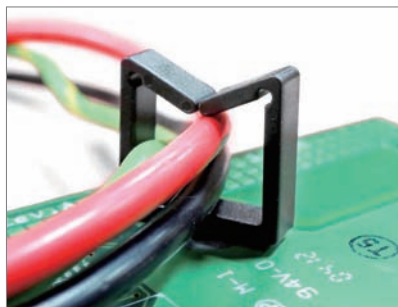

- Material: Nylon 66 (UL)
- Flame Class: 94V-2/94V-0
- Color: Natural/Black
- Unit: mm

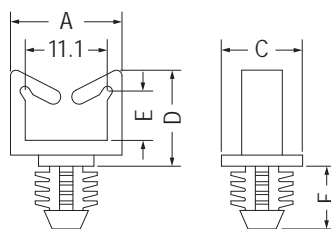

MOUNTING HOLE Ø7.9
THICKNESS 6.4

Part No.	A	C	D	E	F	Package
WSBH-7	15.1	11.0	13.0	6.7	8.5	1000
WSBH-12	15.5	11.1	18.3	12.3	8.5	
WSBH-19	15.2	11.1	27.2	21.0	8.7	
WSBH-29	15.1	11.0	35.0	28.7	8.5	

用途：固定電線於木板或機殼上，維修方便，不佔空間。

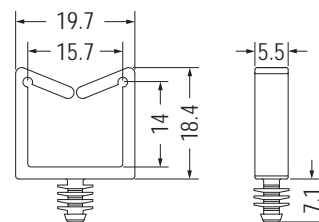

MOUNTING HOLE Ø5.3
THICKNESS 6.4

Part No.	Package
WSBH-13	1000

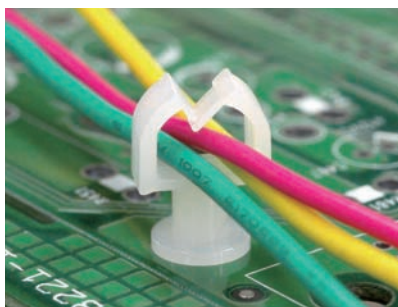

- Material: Nylon 66 (UL)
- Flame Class: 94V-2/94V-0
- Color: Natural/Black
- Unit: mm

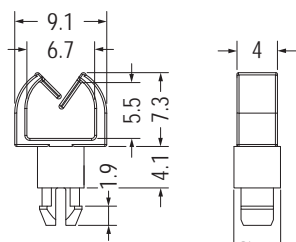

MOUNTING HOLE Ø3.8
THICKNESS 1.6

Part No.	Package
MWSA-2	1000

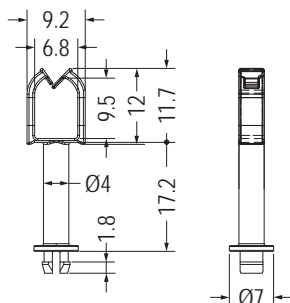
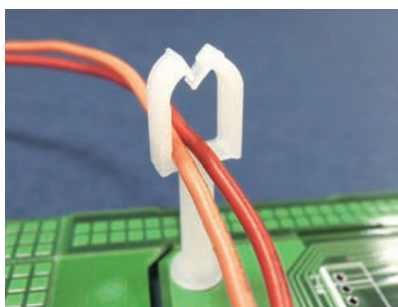

MOUNTING HOLE Ø3.8
THICKNESS 1.7

Part No.	Package
MWSA-17.2	1000

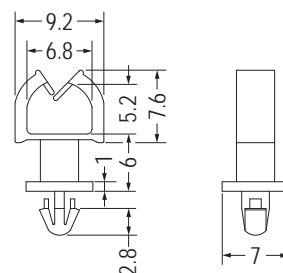

MOUNTING HOLE Ø3.0
THICKNESS 1.0-1.6

Part No.	Package
MWSL-6	1000

電線固定座 WIRE SADDLE

用途：固定電線於PC板或機板上，維修方便，不佔空間。

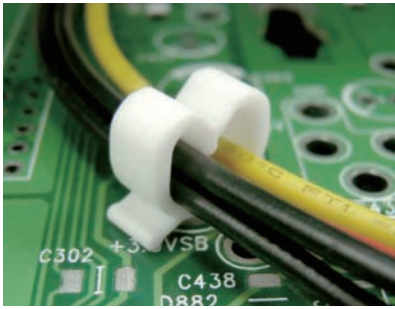

- Material: Nylon 66 (UL)
- Flame Class: 94V-2/94V-0
- Color: Natural/Black
- Unit: mm

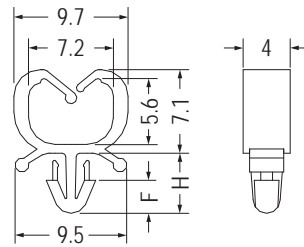

MOUNTING HOLE Ø3.0
THICKNESS 0.6~1.6

Part No.	F	H	Package
MWC-2	2.2	4.5	2000
MWC-6	2.8	5.1	

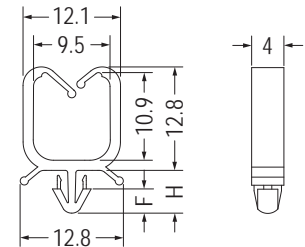

MOUNTING HOLE: ØG
THICKNESS 0.6~1.6

Part No.	F	G	H	Package
MWC-3	2.2	3.0	4.5	2000
MWC-10	3.0	3.5	5.3	

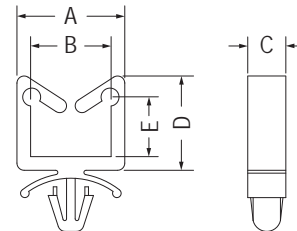
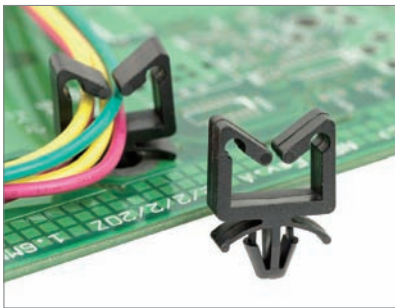

MOUNTING HOLE: ØG
THICKNESS: T



【CHA-3L】



【CHA-5】



【CHA-6】



【CHA-9】

Part No.	A	B	C	D	E	G	T	Package	UL
CHA-1	15.0	11.2	5.3	12.0	7.2	4.8~5.0	0.8~2.0	1000	UL
CHA-1L	15.0	11.2	5.3	12.0	7.2	4.8~5.0	2.2		/
CHA-2	15.0	11.2	5.3	17.0	12.2	4.8~5.0	0.8~2.0	500	UL
CHA-3	15.0	11.2	5.3	26.0	21.2	4.8~5.0	0.8~2.0		UL
CHA-3L	15.0	11.2	5.3	26.0	21.2	4.8~5.0	3.0		/
CHA-4	15.0	11.2	5.3	34.0	29.2	4.8~5.0	0.8~2.0		UL
CHA-5	15.1	11.1	5.6	17.8	11.65	4.75	1.6~3.2		/
CHA-6	15.0	11.2	5.3	17.0	12.2	4.8	0.8~2.2		/
CHA-6L	15.0	11.2	5.3	17.0	12.2	4.8	0.8~2.5	/	
CHA-9	15.0	10.6	5.2	20.0	15.3	4.8	0.8~2.2	/	
CHA-11	15.0	11.2	5.3	12.0	7.2	5.4	0.8~2.0	1000	/

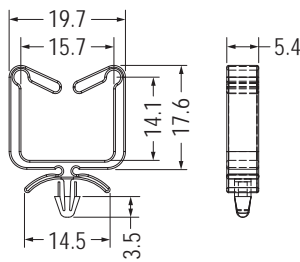

MOUNTING HOLE Ø3.0
THICKNESS 1.6~2.3

Part No.	Package
CHA-8	500

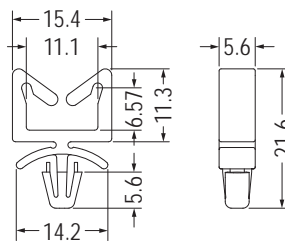

MOUNTING HOLE Ø4.75
THICKNESS 1.6

Part No.	Package
CHA-13	1000

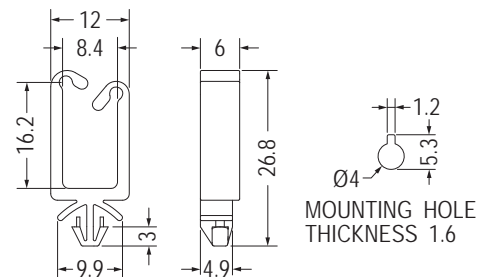

Part No.	Package
CHA-15	500

電線固定座 WIRE SADDLE

用途：固定電線於PC板或機板上，維修方便，不佔空間。

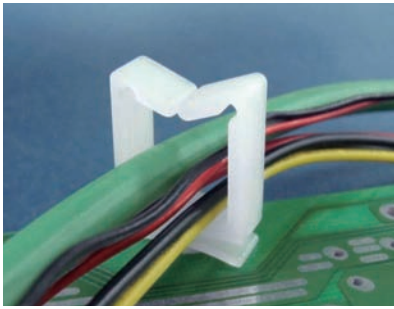

- Material: Nylon 66 (UL)
- Flame Class: 94V-2/94V-0
- Color: Natural/Black
- Unit: mm

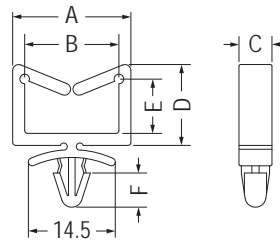

MOUNTING HOLE: $\varnothing G$
THICKNESS: T

Part No.	A	B	C	D	E	F	G	T	Package
CHP-1	19.7	15.7	5.4	18.2	14.0	5.7	4.8-5.0	1.2-2.1	500
CHP-2	15.0	11.0	5.5	17.0	12.6	5.7	4.8-5.0	1.2-2.1	
CHP-3	18.5	14.6	5.5	17.0	12.55	6.1	5.0	1.2-2.0	

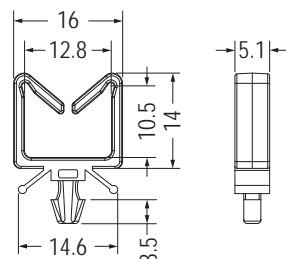
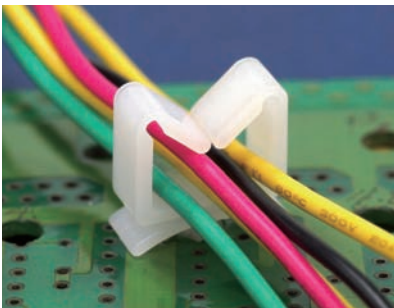

MOUNTING HOLE $\varnothing 3.4$ - $\varnothing 3.5$
THICKNESS 2.5

Part No.	Package
CHPB-1	1000

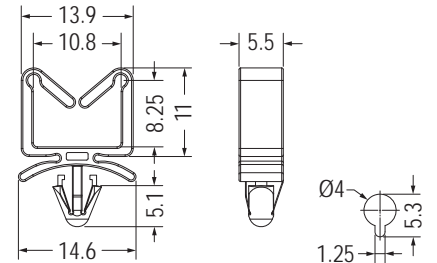

MOUNTING HOLE $\varnothing 4$
THICKNESS 1.6

Part No.	Package
CHA-10	1000

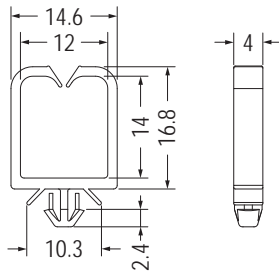

MOUNTING HOLE $\varnothing 4.0$
THICKNESS 0.8-2.0

Part No.	Package
MWS-34	500

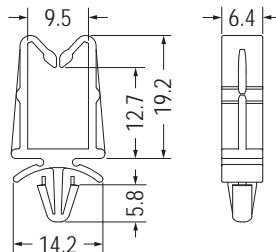

MOUNTING HOLE $\varnothing 4.7$ - $\varnothing 4.9$
THICKNESS 0.8-2.0

Part No.	Package
CHA-14	500

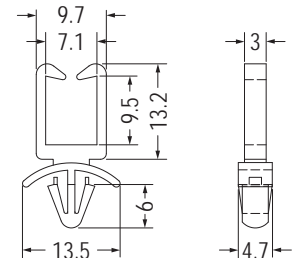

MOUNTING HOLE $\varnothing 4.8$
THICKNESS 0.8-1.6

Part No.	Package
CHAD-1	1000

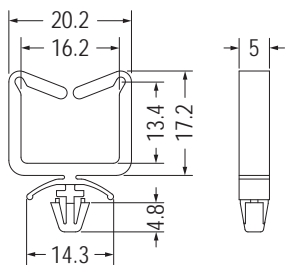

MOUNTING HOLE $\varnothing 4.8$
THICKNESS 1.0-2.5

Part No.	Package
CHR-11	500

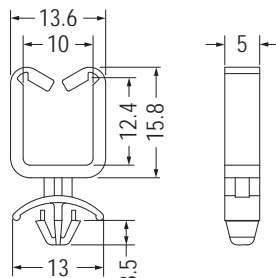

MOUNTING HOLE $\varnothing 5.0$
THICKNESS 0.8-1.6

Part No.	Package
CHX-1	1000

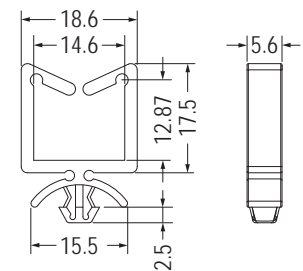

MOUNTING HOLE $\varnothing 5.0$
THICKNESS 2.4-3.0

Part No.	Package
CHPA-1	1000

電線固定座 WIRE SADDLE

用途：固定電線於PC板或機板上，維修方便，不佔空間。

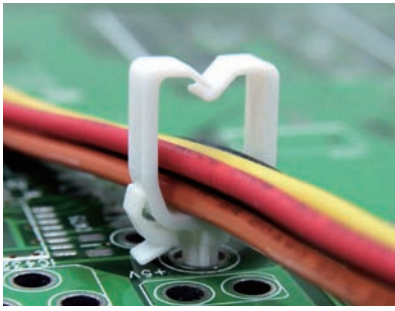

- Material: Nylon 66 (UL)
- Flame Class: 94V-2/94V-0
- Color: Natural/Black
- Unit: mm

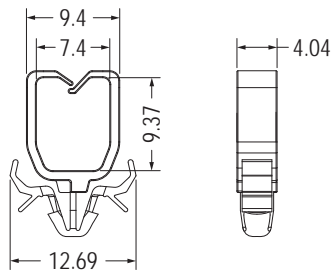

MOUNTING HOLE \varnothing 3.5
THICKNESS 0.6-1.6

Part No.	Package
MWSB-1	2000

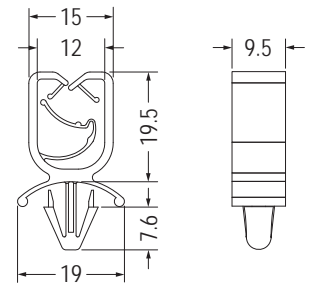

MOUNTING HOLE \varnothing 6.3- \varnothing 7.0
THICKNESS 0.6-3.0

Part No.	Package
MWCA-1	1000

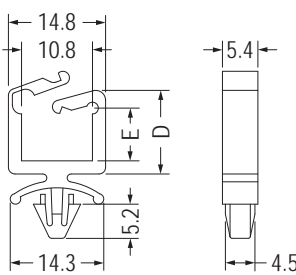
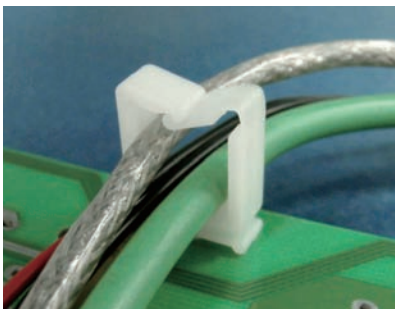

MOUNTING HOLE \varnothing 4.8- \varnothing 5.0
THICKNESS 0.5-2.0

Part No.	D	E	Package
CH-10	15.9	11.2	500
CH-19	25.2	20.5	

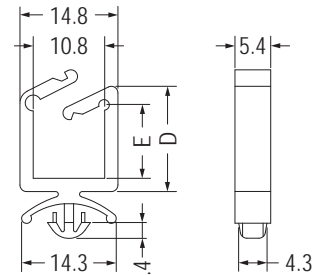

MOUNTING HOLE \varnothing 4.8
THICKNESS 0.8-1.6

Part No.	D	E	Package
CH-11	15.9	11.1	500
CH-13	20.6	15.8	

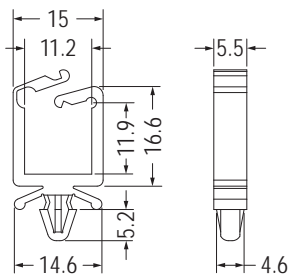

MOUNTING HOLE \varnothing 4.8
THICKNESS 0.8-1.8

Part No.	Package
CH-14	500

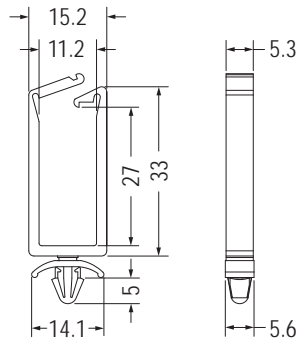

MOUNTING HOLE \varnothing 4.8
THICKNESS: T

Part No.	T	Package
CH-15	0.5-2.3	500
CH-15L	1.5-3.0	

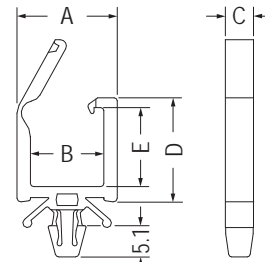

MOUNTING HOLE \varnothing 4.8
THICKNESS 0.5-2.0

Part No.	A	B	C	D	E	Package
CHF-1	16.4	12.0	4.6	21.5	17.4	500
CHF-2	14.4	10.4	4.6	16.5	12.4	
CHF-3	18.4	14.0	5.0	24.0	20.0	

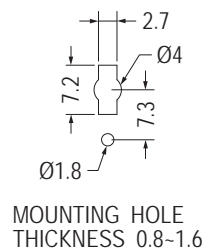
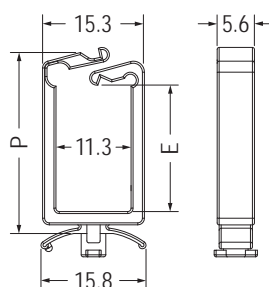

MOUNTING HOLE
THICKNESS 0.8-1.6

Part No.	E	P	Package
CHZC-1	4.8	13.0	500
CHZC-2	9.8	18.8	
CHZC-3	19.0	27.2	
CHZC-4	26.8	35.1	

電線固定座 WIRE SADDLE

用途：固定電線於PC板或機板上，維修方便，不佔空間。

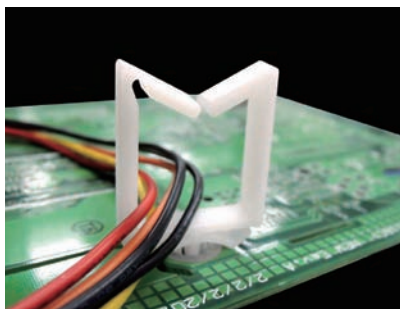

- Material: Nylon 66 (UL)
- Flame Class: 94V-2/94V-0
- Color: Natural/Black
- Unit: mm

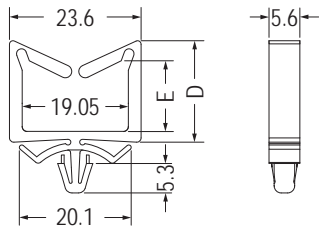

MOUNTING HOLE $\varnothing 4.75$
THICKNESS 1.2

Part No.	D	E	Package
CHAH-1	18.2	12.7	500
CHAH-2	27.1	21.6	

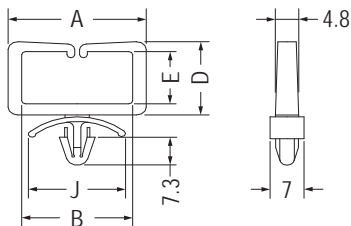
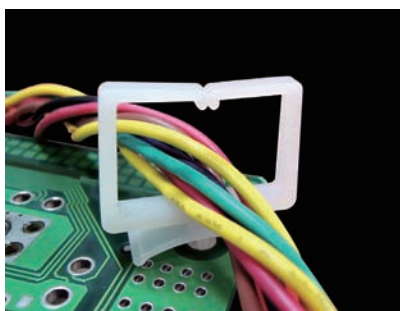

MOUNTING HOLE $\varnothing 4.8$ - $\varnothing 5.0$
THICKNESS: T

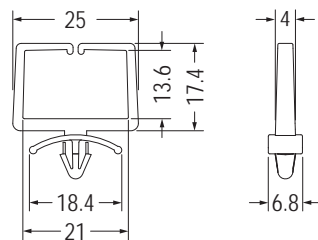

MOUNTING HOLE $\varnothing 4.8$ - $\varnothing 5.0$
THICKNESS 0.8-2.5

Part No.	A	B	D	E	J	T	Package
CHE-1	28.5	22.9	19.2	13.6	20.2	1.1-3.5	500
CHE-2	42.0	36.0	66.0	60.3	20.1	0.8-4.0	

Part No.	Package
CHE-3	500

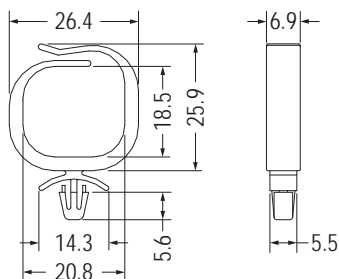

MOUNTING HOLE $\varnothing 4.8$ - $\varnothing 5.5$
THICKNESS 0.8-2.0

Part No.	Package
CHD-18	250

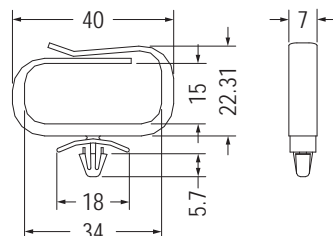

MOUNTING HOLE $\varnothing 4.8$ - $\varnothing 5.5$
THICKNESS 0.8-2.0

Part No.	Package
CHD15-34	250

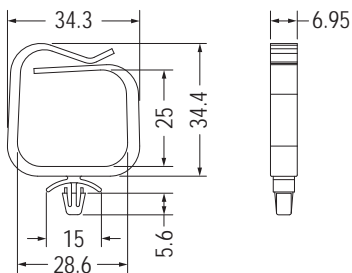
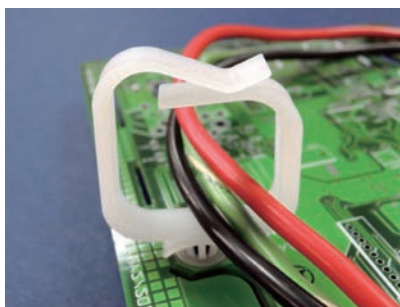

MOUNTING HOLE $\varnothing 4.8$
THICKNESS 0.8-2.0

Part No.	Package
CHD-20	250

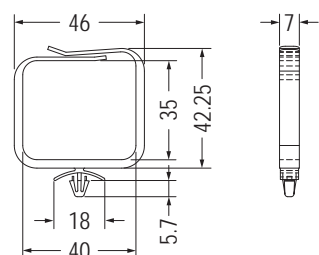

MOUNTING HOLE $\varnothing 4.8$
THICKNESS 0.8-2.0

Part No.	Package
CHD35-40	200

電線固定座 WIRE SADDLE

用途：固定電線於PC板或機板上，維修方便，不佔空間。

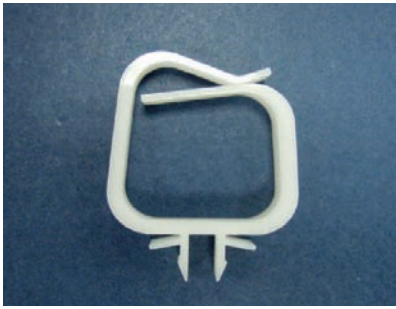

- Material: Nylon 66 (UL)
- Flame Class: 94V-2/94V-0
- Color: Natural/Black
- Unit: mm

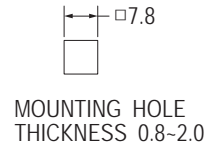
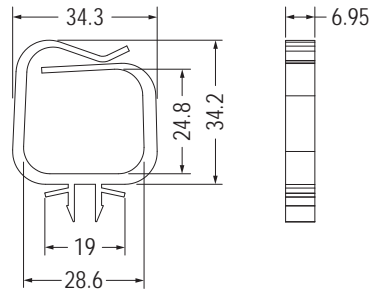

Part No.	Package
CHD-19	250

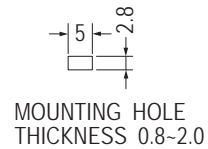
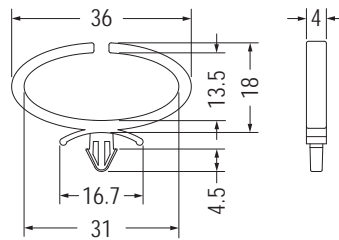

Part No.	Package
WUCD-36	1000

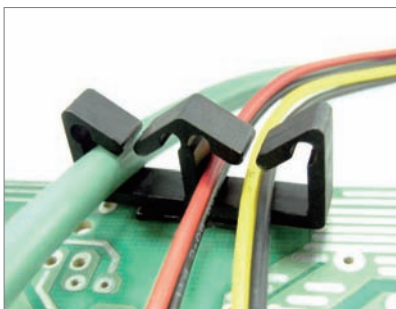

- Material: Nylon 66 (UL)
- Flame Class: 94V-2/94V-0
- Color: Natural/Black
- Unit: mm

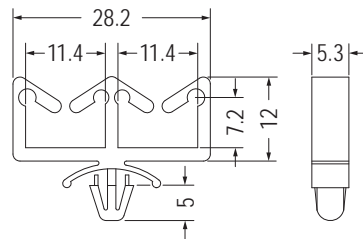

【 CHAA-3 】

MOUNTING HOLE: ØG
THICKNESS 1.2-2.1

Part No.	G	Package
CHAA-1	4.8-5.0	1000
CHAA-3	4.8	

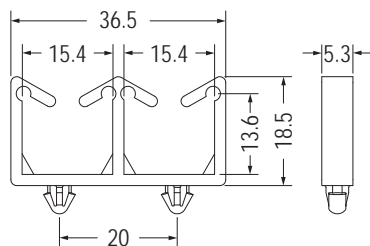

MOUNTING HOLE Ø4.0
THICKNESS 1.0

Part No.	Package
CHAA-4	500

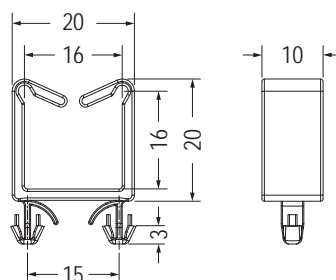

MOUNTING HOLE Ø4.0
THICKNESS 0.8-2.5

Part No.	Package
CHAF-3	1000

電線固定座 WIRE SADDLE

用途：固定電線於PC板或機板上，維修方便，不佔空間。

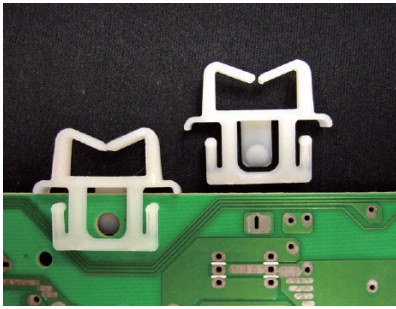

- Material: Nylon 66 (UL)
- Flame Class: 94V-2/94V-0
- Color: Natural/Black
- Unit: mm

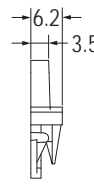
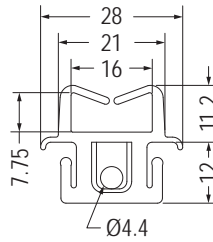

MOUNTING DETAIL

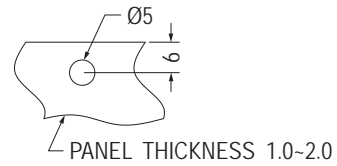

Part No.	Package
EDGE-1	500

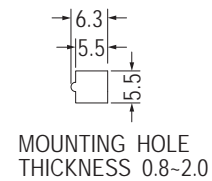
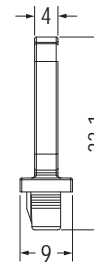
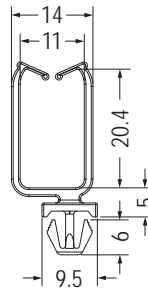
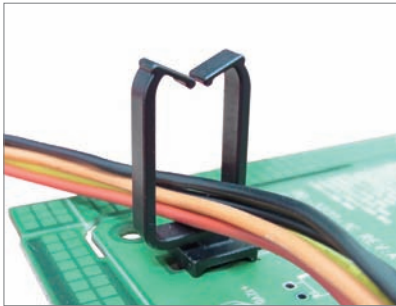

MOUNTING HOLE THICKNESS 0.8-2.0

Part No.	Package
WSSA-1	500

4

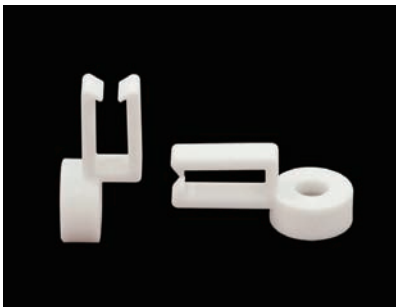

- Material: Nylon 66 (UL)
- Flame Class: 94V-2/94V-0
- Color: Natural/Black
- Unit: mm

用途：用於固定電線。

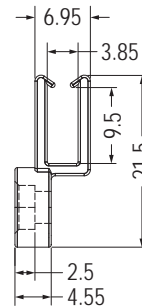
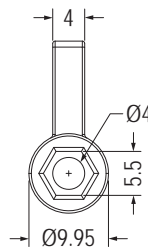

Part No.	Package
THP-1	500



- Material: Nylon 66 (UL)
- Flame Class: 94V-2/94V-0
- Color: Natural/Black
- Unit: mm

用途：將電線固定於LCD-TV上，電線不易磨損，配線整齊美觀。

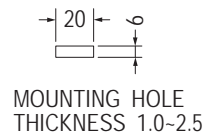
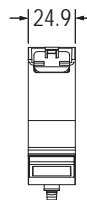
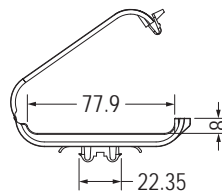

MOUNTING HOLE THICKNESS 1.0-2.5

Part No.	Package
CMKB-1	50

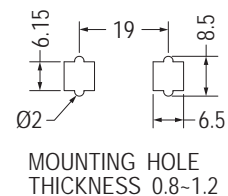
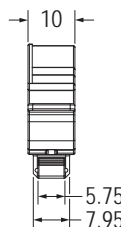
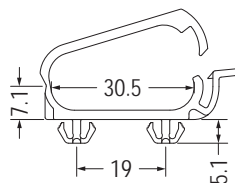

MOUNTING HOLE THICKNESS 0.8-1.2

Part No.	Package
CMKB-2	250

電線固定座 WIRE MOUNT

用途：將電線固定於LCD-TV上，電線不易磨損，配線整齊美觀。



- Material: PP (UL)
- Flame Class: 94HB
- Color: Computer/Black
- Unit: mm

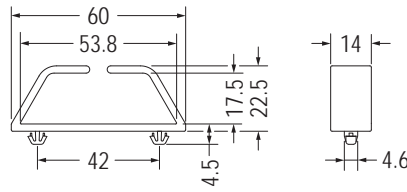

MOUNTING HOLE $\varnothing 4.8$
THICKNESS 1.5

Part No.	Package
CHT-42	100

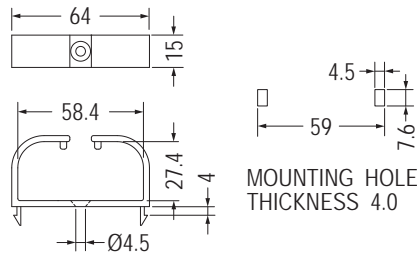

MOUNTING HOLE
THICKNESS 4.0

Part No.	Package
CHV-59	100

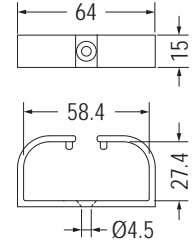

Part No.	Package
CHV-59K	100



- Material: PP (UL)
- Flame Class: 94HB
- Color: Natural
- Unit: mm

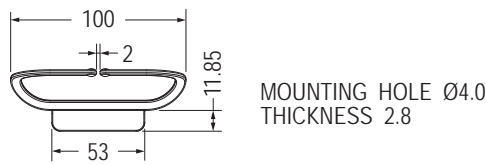

MOUNTING HOLE $\varnothing 4.0$
THICKNESS 2.8

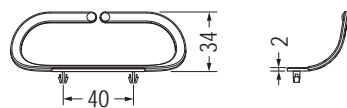

Part No.	Package
WUCD-100	100

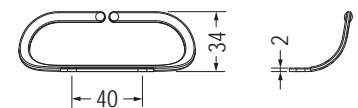
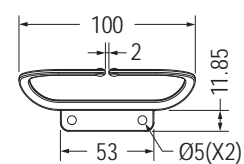

Part No.	Package
WUCDF-100	100

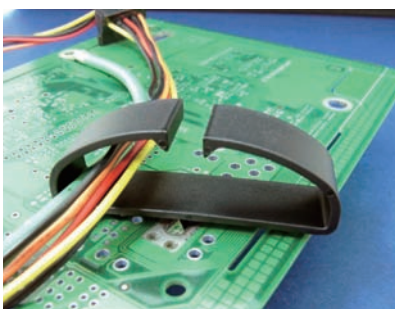

- Material: Nylon 66 (UL)
- Flame Class: 94V-2/94V-0
- Color: Natural/Black
- Unit: mm

用途：固定電線於PC板或機板上，維修方便，不佔空間。

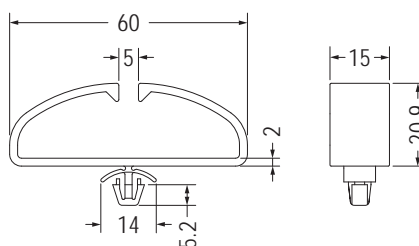

MOUNTING HOLE $\varnothing 6.0$
THICKNESS 0.8-2.5

Part No.	Package
CHAU-1	500

電線固定座 WIRE SADDLE

用途：固定電線於PC板或機板上，維修方便，不佔空間。

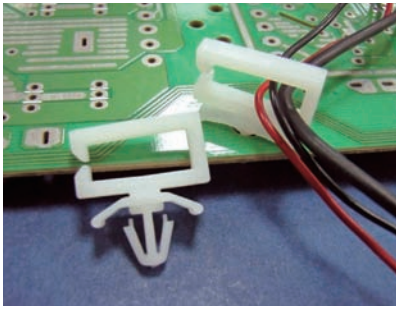

- Material: Nylon 66 (UL)
- Flame Class: 94V-2/94V-0
- Color: Natural/Black
- Unit: mm

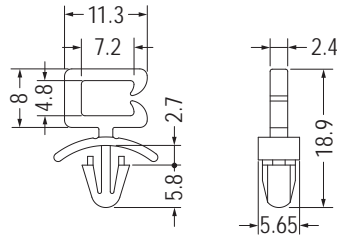

MOUNTING HOLE $\varnothing 4.8$
THICKNESS 0.8-2.0

Part No.	Package
WAS-1	1000

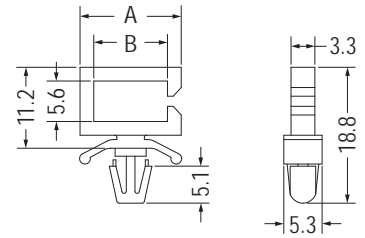

MOUNTING HOLE $\varnothing 4.8$
THICKNESS 0.8-2.0

Part No.	A	B	Package
WSS-2	14.0	10.2	1000
WSS-2L	17.0	13.2	

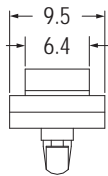
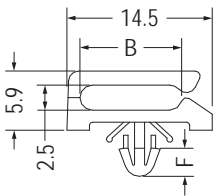

MOUNTING HOLE: $\varnothing G$
THICKNESS: T

Part No.	B	F	G	T	Package
MIS-2	10.2	2.8	3.0	0.6~1.8	1000
MIS-9	10.15	3.15	4.0	1.6	

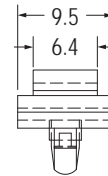
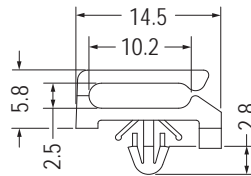

$\varnothing 3$
MOUNTING HOLE $\varnothing 3.0$
THICKNESS: T

Part No.	T	Package
MIS-11	0.6~1.8	2000
MIS-11L	1.0~2.2	

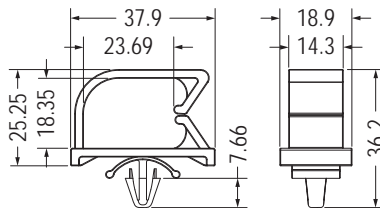
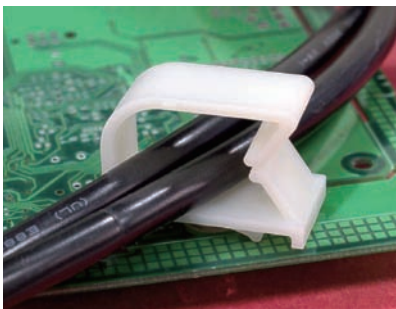

MOUNTING HOLE $\varnothing 6.4$
THICKNESS 1.9

Part No.	Package
MIS-20	250

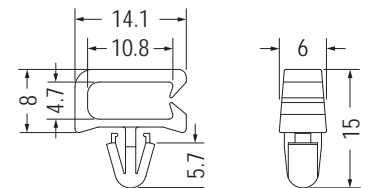

MOUNTING HOLE $\varnothing 4.8$
THICKNESS 0.8-1.6

Part No.	Package
MIS-3	2000

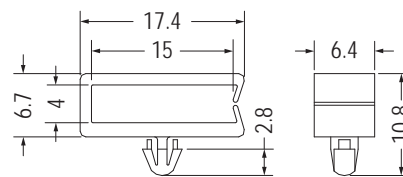
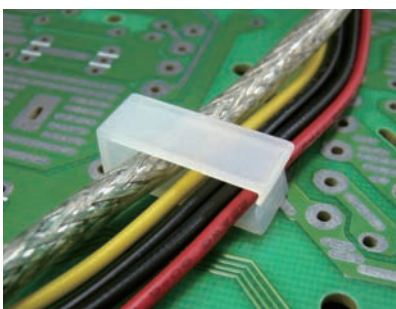

MOUNTING HOLE $\varnothing 3.0$
THICKNESS 1.0

Part No.	Package
MIS-5	2000

電線固定座 WIRE SADDLE

用途：固定電線於PC板或機板上，維修方便，不佔空間。



- Material: Nylon 66 (UL)
- Flame Class: 94V-2/94V-0
- Color: Natural/Black
- Unit: mm

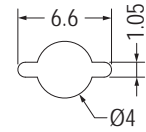
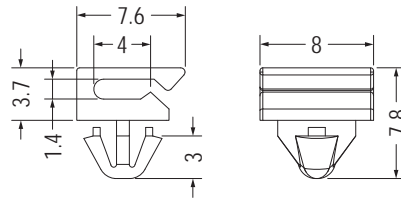

MOUNTING HOLE THICKNESS 0.8

Part No.	Package
MIS-14	2000

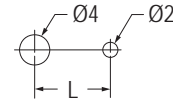
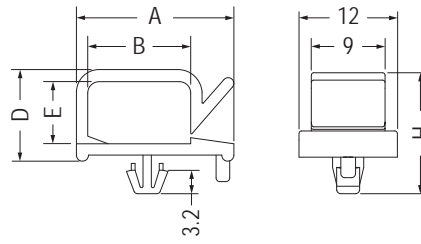

MOUNTING HOLE THICKNESS: T

Part No.	A	B	D	E	H	L	T	Package
MIS-7	20.8	13.6	12.5	8.2	16.9	10.0	0.6~0.8	500
★MIS-7M	20.8	13.6	12.5	8.2	17.0	10.0	0.8~1.2	
MIS-8	16.8	10.5	10.3	6.5	14.3	7.0	0.8~1.0	
MIS-8M	16.8	10.5	10.3	6.5	14.8	7.0	1.2	
MIS-8L	16.8	10.5	10.3	6.5	15.2	7.0	1.6	

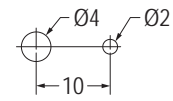
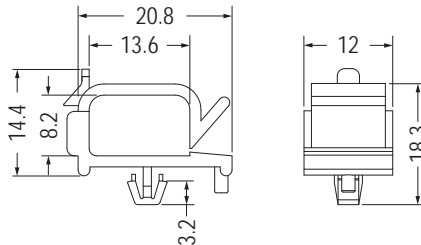
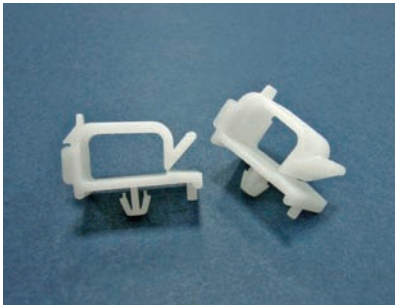

MOUNTING HOLE THICKNESS 0.6~1.0

Part No.	Package
MIS-10	1000

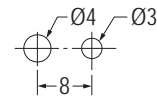
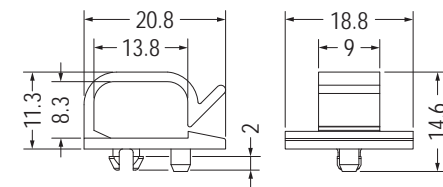
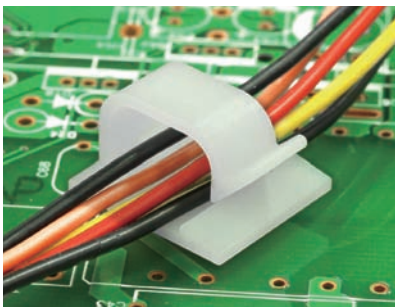

MOUNTING HOLE THICKNESS 1.0

Part No.	Package
MIS-17	1000

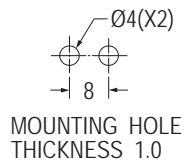
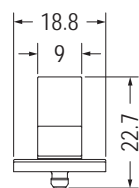
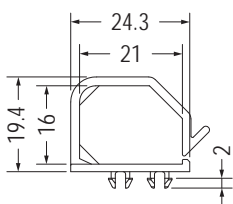

MOUNTING HOLE THICKNESS 1.0

Part No.	Package
MIS-21	1000

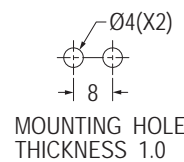
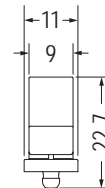
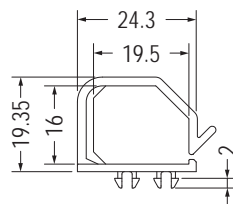

MOUNTING HOLE THICKNESS 1.0

Part No.	Package
★MIS-29	500

電線固定座 WIRE SADDLE

用途：固定電線於PC板或機板上，維修方便，不佔空間。



- Material: Nylon 66 (UL)
- Flame Class: 94V-2/94V-0
- Color: Natural/Black
- Unit: mm

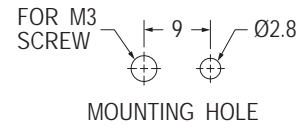
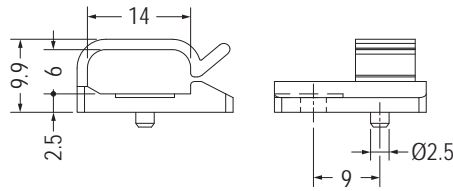

Part No.	Package
WCLB-1	1000

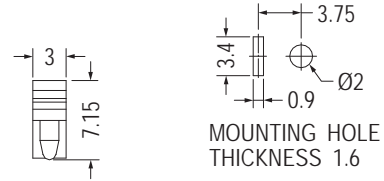
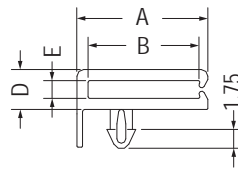
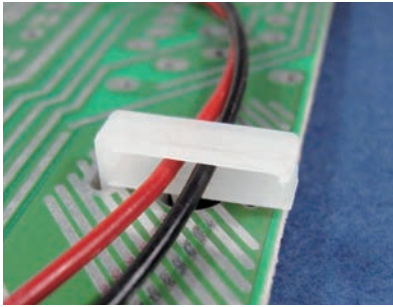

Part No.	A	B	D	E	Package
MIS-4	11.8	10.0	3.6	1.6	1000
MIS-23	14.8	12.48	4.3	2.3	

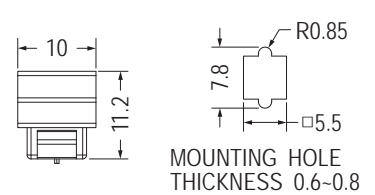
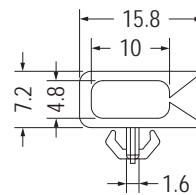
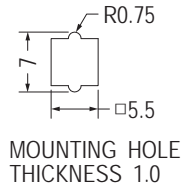
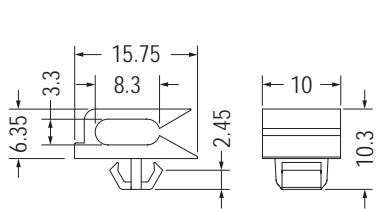

Part No.	Package
MIS-6	1000

Part No.	Package
★MIS-28	1000

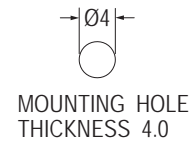
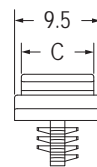
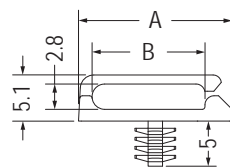
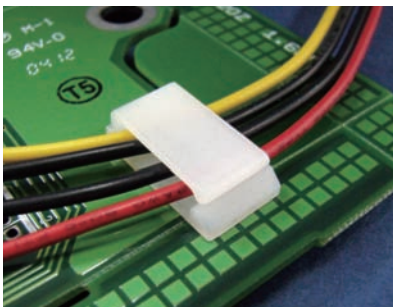

Part No.	A	B	C	Package
MISB-1	17.0	12.5	8.0	1000
MISB-2	12.7	8.3	6.4	

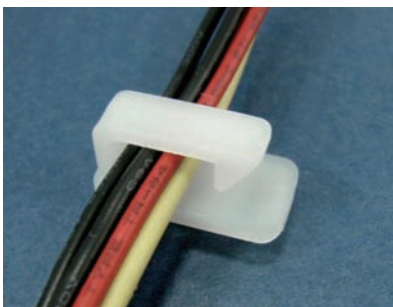

- Material: Nylon 66 (UL)
- Flame Class: 94V-2/94V-0
- Color: Natural/Black
- Unit: mm

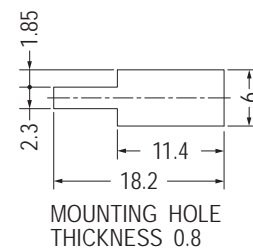
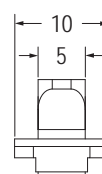
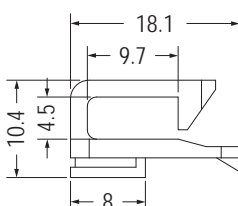

Part No.	Package
MISA-1	1000

用途：快速拆卸，固定電線維修方便，不佔空間。

電線固定座 WIRE SADDLE

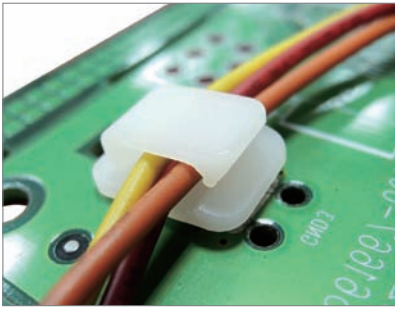

- Material: Nylon 66 (UL)
- Flame Class: 94V-2/94V-0
- Color: Natural/Black
- Unit: mm

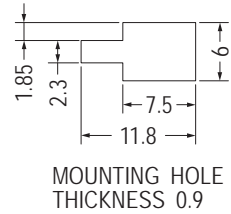
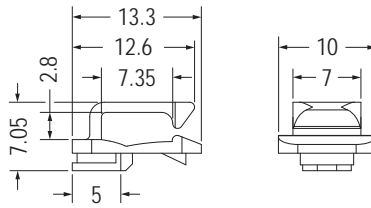

MOUNTING HOLE THICKNESS 0.9

Part No.	Package
MISA-2	1000

用途：快速拆卸，固定電線維修方便，不佔空間。

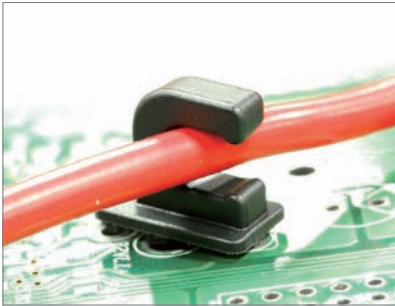

- Material: ABS (UL)
- Flame Class: 94V-0
- Color: Black
- Unit: mm

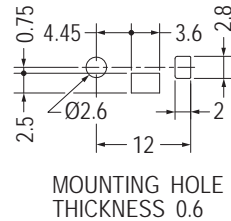
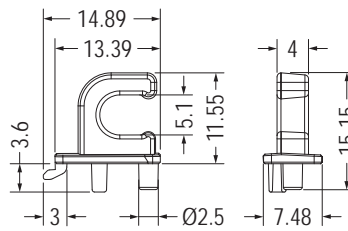

MOUNTING HOLE THICKNESS 0.6

Part No.	Package
MISE-1	1000

電線固定座 FLAT CABLE CLAMP

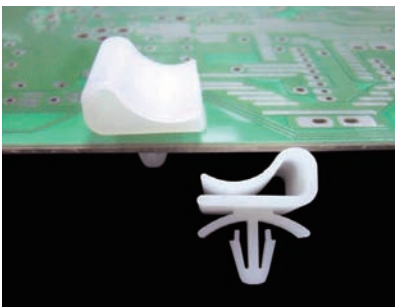

- Material: Nylon 66 (UL)
- Flame Class: 94V-2/94V-0
- Color: Natural/Black
- Unit: mm

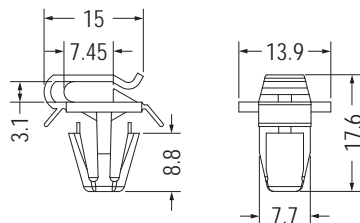

MOUNTING HOLE Ø8.0 THICKNESS 1.0-2.8

Part No.	Package
FCCA-1	1000

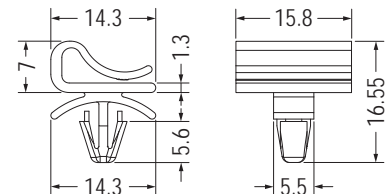

MOUNTING HOLE Ø4.8 THICKNESS 0.6-2.0

Part No.	Package
FCCB-1	1000

用途：快速固定電線，安裝容易。

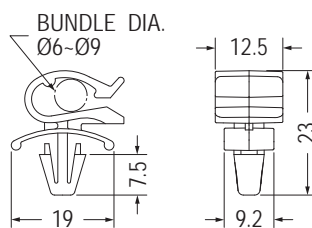
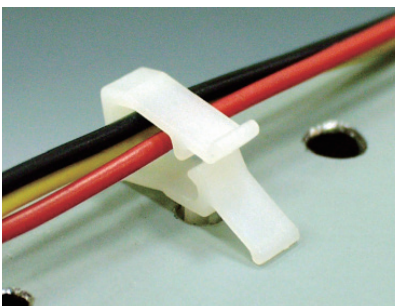

MOUNTING HOLE Ø6.3-Ø6.5 THICKNESS 1.0-3.0

Part No.	Package
FCCD-1	1000

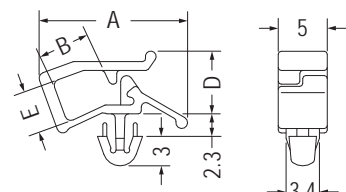

MOUNTING HOLE Ø3.5 THICKNESS 0.5-1.6

Part No.	A	B	D	E	Package
WPEM-1	20.3	7.2	8.5	6.2	1000
WPEM-1S	15.2	5.3	6.4	4.3	
WPEM-2	13.5	4.1	5.0	2.6	

排線固定座 FLAT CABLE CLAMP



- Material: Nylon 66 (UL)
- Flame Class: 94V-2/94V-0
- Color: Natural/Black
- Unit: mm

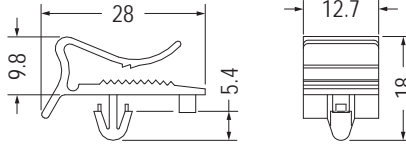

用途：用於電子、電腦內部電線固定，裝配容易，美觀不脫落，固定力強。

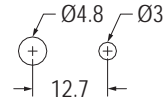

MOUNTING HOLE THICKNESS 0.8-2.5

Part No.	Package
FCCT-12	500

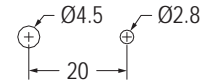
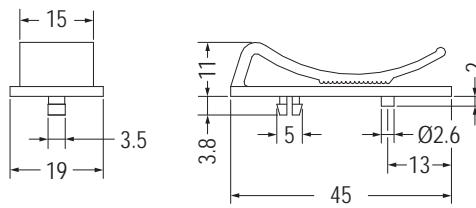
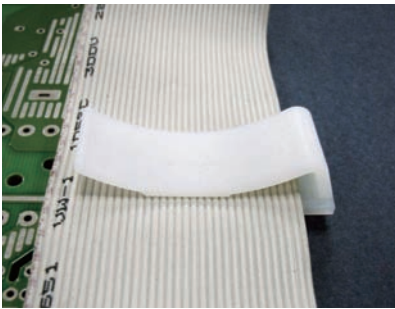

MOUNTING HOLE CHASSIS THICKNESS 1.2

Part No.	Package
FCG-15	1000

4

電線固定座 WIRE SADDLE

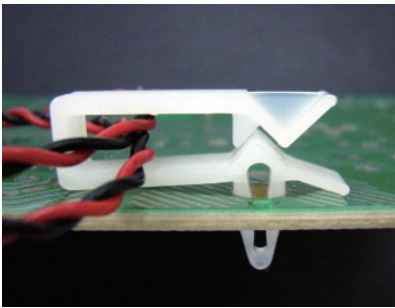

- Material: Nylon 66 (UL)
- Flame Class: 94V-2/94V-0
- Color: Natural/Black
- Unit: mm

用途：固定電線於PC板或機板上，維修方便，不佔空間。

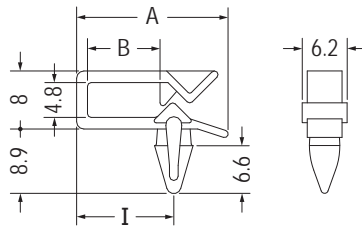

MOUNTING HOLE Ø4.8 THICKNESS 2.0

Part No.	A	B	I	Package
WPEG-1	20.9	10.0	13.4	1000
WPEG-2	24.2	13.2	16.8	
WPEG-3	17.5	6.6	10.8	

電線固定座 FLAT CABLE CLAMP



- Material: Nylon 66 (UL)
- Flame Class: 94V-2/94V-0
- Color: Natural/Black
- Unit: mm

用途：固定電線於PC板或機板上，維修方便，不佔空間。

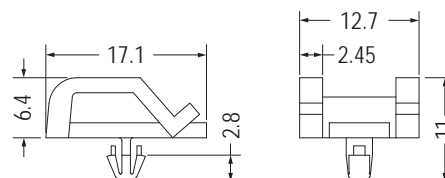

MOUNTING HOLE Ø3.0 THICKNESS 1.6

Part No.	Package
FCPT-1	1000

電線固定座 WIRE SADDLE

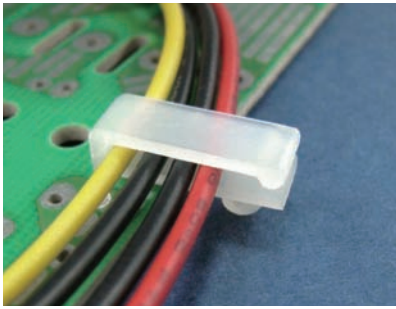

- Material: Nylon 66 (UL)
- Flame Class: 94V-2/94V-0
- Color: Natural/Black
- Unit: mm

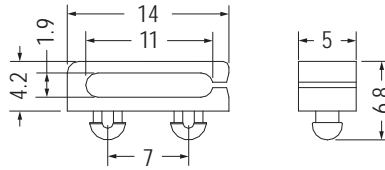

MOUNTING HOLE $\varnothing 3.0$
THICKNESS 0.8-1.0

Part No.	Package
MWS-4	2000

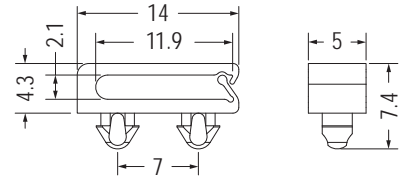

MOUNTING HOLE $\varnothing 3.0$
THICKNESS 0.8-1.0

Part No.	Package
MIS-18	1000

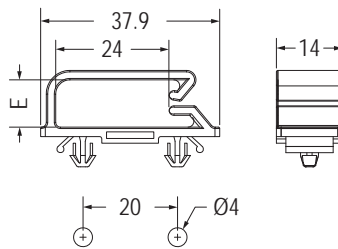
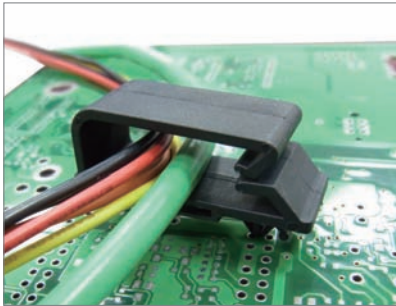

MOUNTING HOLE
THICKNESS 0.8-2.0

Part No.	E	Package
MIBA-1	18.7	200
MIBA-2	10.0	500

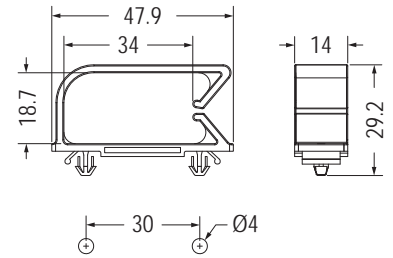

MOUNTING HOLE
THICKNESS 0.8-2.0

Part No.	Package
MIBA-3	500

電線固定扣 CABLE CLAMP

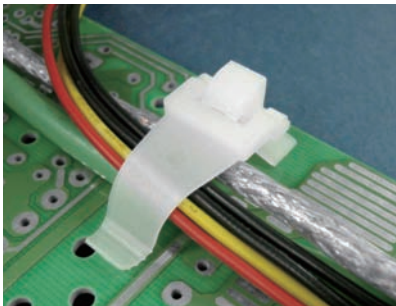

- Material: Nylon 66 (UL)
- Flame Class: 94V-2/94V-0
- Color: Natural/Black
- Unit: mm

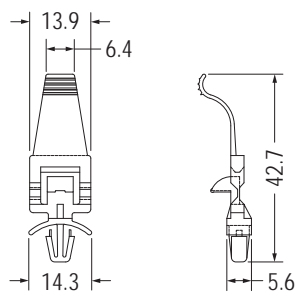

MOUNTING HOLE $\varnothing 4.8$
THICKNESS 1.2-2.0

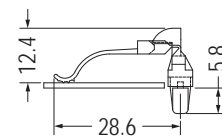

Part No.	Package
HFCC-12	1000

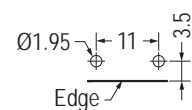
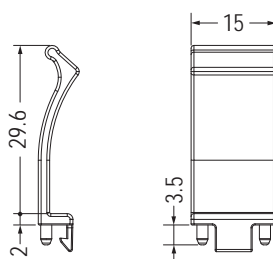

MOUNTING HOLE
THICKNESS 2.1

Part No.	Package
HFCD-29	1000

電線固定座 CABLE CLAMP



- Material: Nylon 66 (UL)
- Flame Class: 94V-2/94V-0
- Color: Natural/Black
- Unit: mm

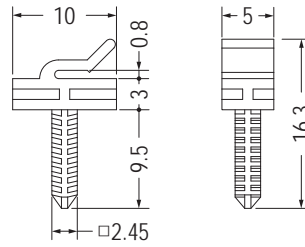

MOUNTING HOLE $\varnothing 3.0$

用途：固定電線於木板或機殼上，維修方便，不佔空間。

Part No.	Package
WSBC-1	1000

風扇束線座 FAN CABLE TIE MOUNT

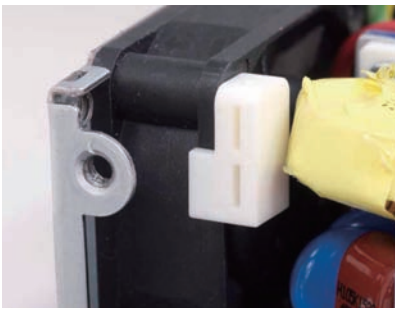

- Material: Nylon 66 (UL)
- Flame Class: 94V-2/94V-0
- Color: Natural/Black
- Unit: mm

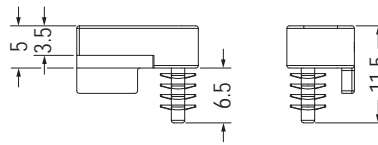

MOUNTING HOLE $\varnothing 3.5$

用途：風扇電線之固定，整齊美觀。

Part No.	Package
WKM-2	1000

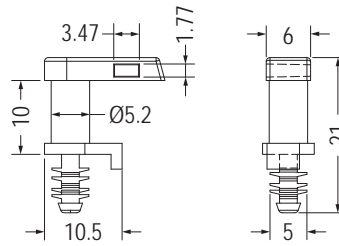
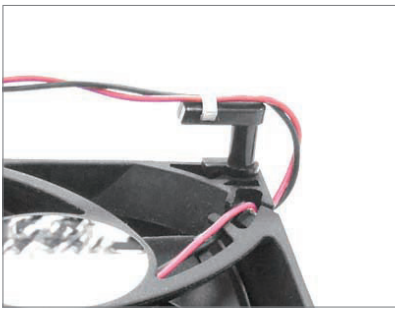

MOUNTING HOLE $\varnothing 4.4$

Part No.	Package
WKM-10	500

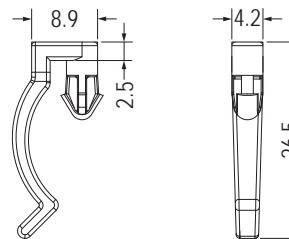
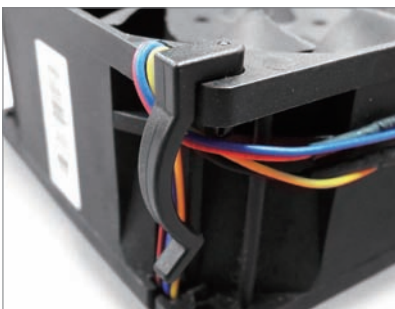

MOUNTING HOLE $\varnothing 4.3$
THICKNESS 4.0

Part No.	Package
WKA-1	1000

電線固定座 CABLE CLAMP



- Material: Nylon 66 (UL)
- Flame Class: 94V-2/94V-0
- Color: Natural/Black
- Unit: mm

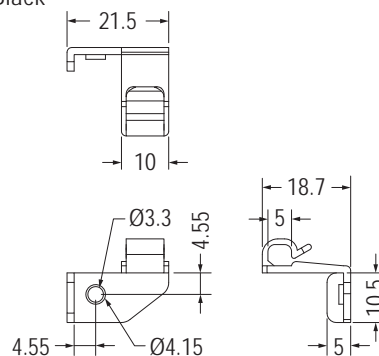

用途：固定電線於機板上，維修方便，不佔空間。

Part No.	Package
MISA-4	1000

電線固定座 CABLE CLAMP

用途：固定電線於板機板上，維修方便，不佔空間。

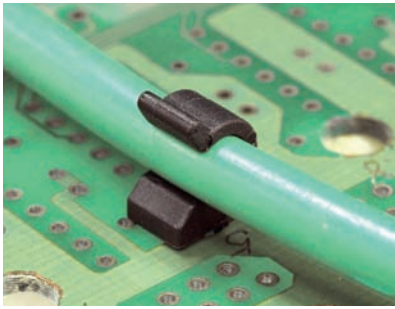

- Material: Nylon 66 (UL)
- Flame Class: 94V-2/94V-0
- Color: Natural/Black
- Unit: mm

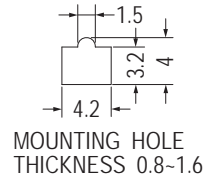
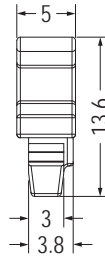
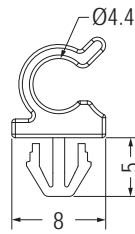

Part No.	Package
CHQ-4.5	1000

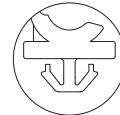
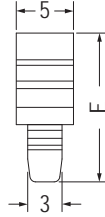
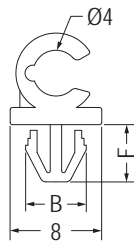
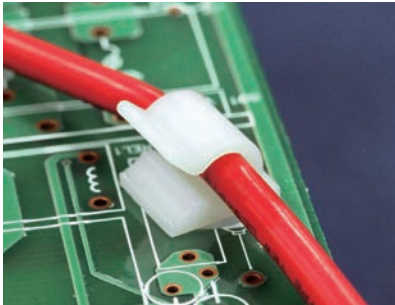

【 CHQ-4S 】

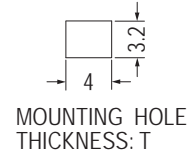

Part No.	B	E	F	T	Package
CHQ-4	5.3	13.0	5.0	1.0-1.6	500
CHQ-4S	4.9	10.9	2.9	1.0	
CHQ-4L	5.5	13.0	5.0	1.0-1.6	

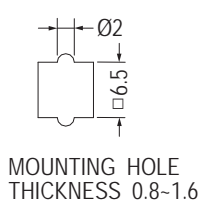
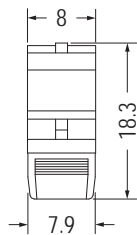
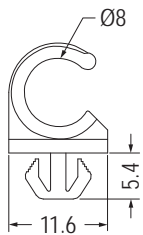

Part No.	Package
CH-9	1000

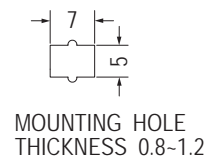
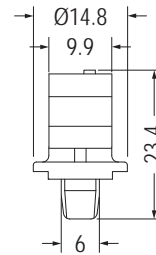
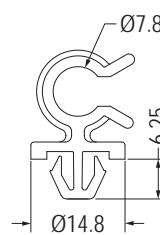

Part No.	Package
CH-12	1000

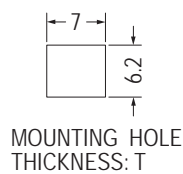
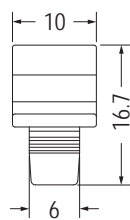
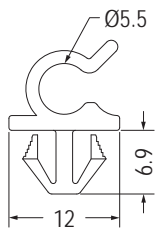

Part No.	T	Package
CHQC-1	2.0	1000
CHQC-1L	0.7-2.0	

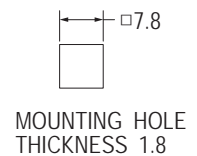
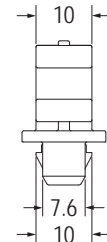
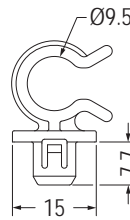

Part No.	Package
CHQF-1	1000

電線固定座 WIRE HOLDER

用途：固定電線於機板上，維修方便，不佔空間。



- Material: Nylon 66 (UL)
- Flame Class: 94V-2/94V-0
- Color: Natural/Black
- Unit: mm

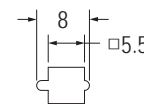
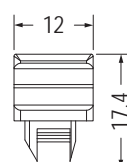
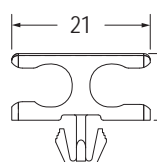

MOUNTING HOLE THICKNESS 2.5

Part No.	Package
CHQE-1	1000

電線固定座 WIRE HOLDER

用途：可快速固定及解開電線。

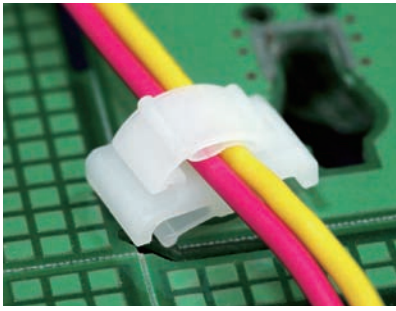

- Material: Nylon 66 (UL)
- Flame Class: 94V-2/94V-0
- Color: Natural/Black
- Unit: mm

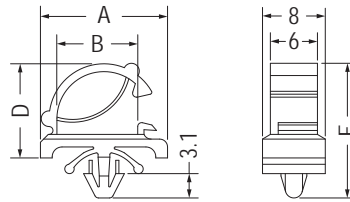

MOUNTING HOLE $\text{\O}3.5$
THICKNESS: T

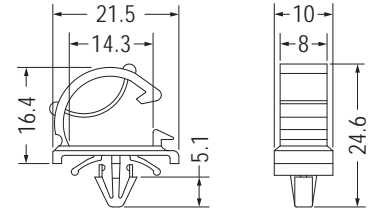

MOUNTING HOLE $\text{\O}4.8$
THICKNESS 0.8-2.5

Part No.	A	B	D	E	T	Package
WLO-1	13.5	6.2	8.2	14.0	0.8-2.0	1000
WLO-1-2.5	13.5	6.2	8.6	14.6	0.8-2.5	
WLO-2	16.2	10.3	12.0	17.6	0.8-2.0	
WLO-2-2.5	16.2	10.3	12.0	18.0	0.8-2.5	

Part No.	Package
WLO-3	500

電線固定座 CABLE CLAMP

用途：固定電線於PC板或機板上，維修方便，不佔空間。

4



- Material: Nylon 66 (UL)
- Flame Class: 94V-2/94V-0
- Color: Natural/Black
- Unit: mm

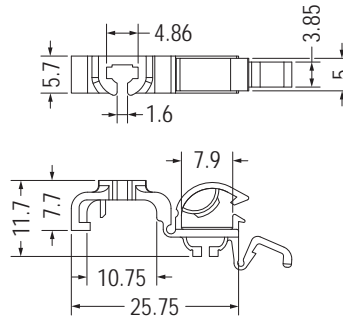

Part No.	Package
EMF-6	500

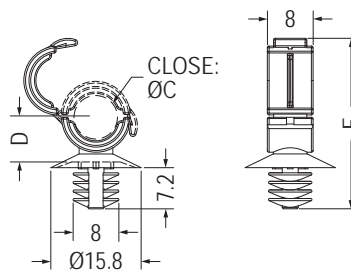
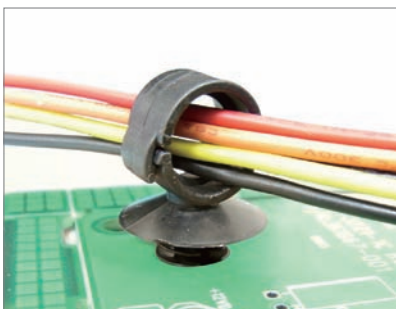

MOUNTING HOLE $\text{\O}6.5\text{-}\text{\O}7.0$
THICKNESS 0.8-9.0

Part No.	C	D	E	Package
CCMK-1	5.5	6.3	24.4	1000
CCMK-2	8.0	7.7	29.8	

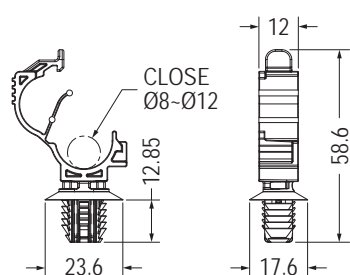

MOUNTING HOLE
THICKNESS 0.6-6.75
(RECOMMEND FOR REFERENCE ONLY)

Part No.	Package
★CCML-1	1000

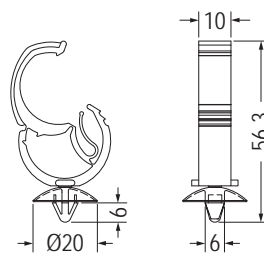

MOUNTING HOLE $\text{\O}6.2\text{-}\text{\O}6.7$
THICKNESS 0.5-2.0

Part No.	Package
CCMI-1	1000

電線固定座 CABLE CLAMP

用途：固定電線於PC板或機板上，維修方便，不佔空間。

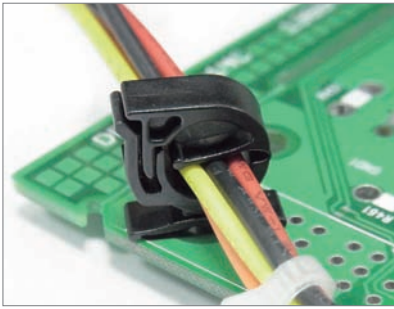

- Material: Nylon 66 (UL)
- Flame Class: 94V-2/94V-0
- Color: Natural/Black
- Unit: mm

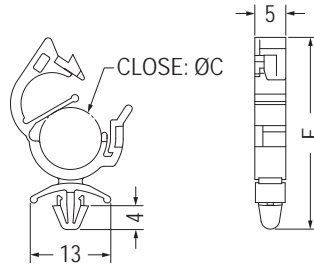

MOUNTING HOLE Ø4.0
THICKNESS 0.8-1.6

Part No.	C	E	Package
CHN-7.6	7.6	26.7	500
CHN-10	10.0	31.0	
CHN-12	12.0	34.4	

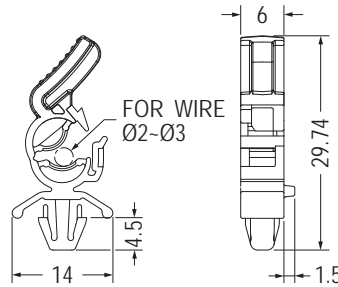
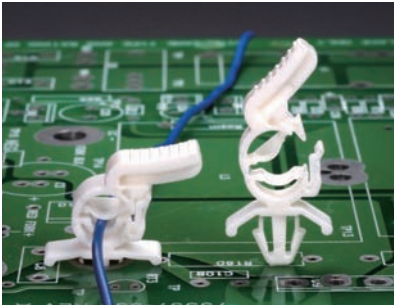

MOUNTING HOLE Ø4.8
THICKNESS 0.5-2.0
(RECOMMEND FOR REFERENCE ONLY)



Part No.	Package
CHNA-1	1000

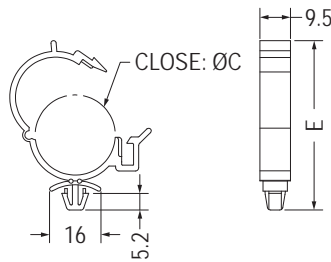

MOUNTING HOLE Ø6.5
THICKNESS: T

Part No.	C	E	T	Package
FWT-25	25.0	52.8	0.8-1.6	100
FWT-30	30.0	59.7	0.8-2.0	

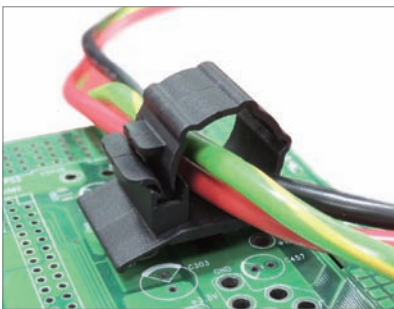

- Material: Nylon 66 (UL)
- Flame Class: 94V-2/94V-0
- Color: Natural/Black/Gray
- Unit: mm

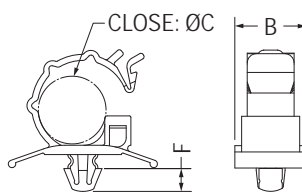

MOUNTING HOLE Ø6.4
THICKNESS: T

Part No.	B	C	F	T	Package
CKS-7	15.0	7.0	4.9	0.8-2.3	200
CKS-10	17.2	10.3	4.9	0.8-2.3	
CKS-13-L	19.2	13.0	4.9	0.5-2.3	
CKS-14	19.3	14.8	4.9	0.8-2.3	
CKS-16-L	21.3	16.0	4.9	0.5-2.3	
CKS-20-L	23.2	20.0	4.9	0.5-2.3	
CKS-20-H	23.2	20.0	4.9	2.3-4.1	100
CKS-26-L	31.4	28.0	5.0	0.5-2.3	

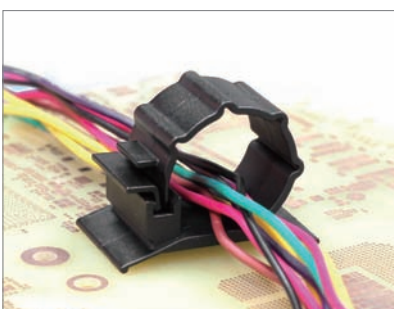

- Material: Nylon 66 (UL)
- Flame Class: 94V-2/94V-0
- Color: Natural/Black
- Unit: mm

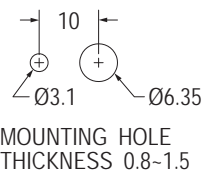
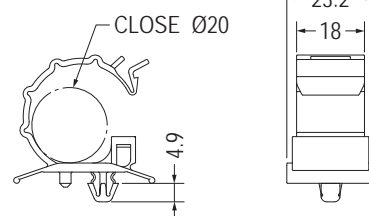

MOUNTING HOLE
THICKNESS 0.8-1.5

Part No.	Package
CKSA-20-L	200

T8燈管固定座 T8 LAMP MOUNT

用途：可固定T8 LED燈管或電線使用。



- Material: Nylon 66 (UL)
- Flame Class: 94V-2/94V-0
- Color: Natural/Black
- Unit: mm

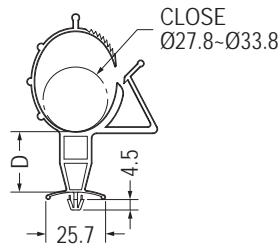

MOUNTING HOLE Ø5.5
THICKNESS 1.0-1.2

Part No.	D	Package
AWD-1	26.0	50
AWD-2	9.0	100
AWD-3	26.0	50

電線固定座 CABLE CLAMP

用途：可固定電源線，避免不小心脫落，造成電腦停機。



- Material: Nylon 66 (UL)
- Flame Class: 94V-2/94V-0
- Color: Natural/Black
- Unit: mm

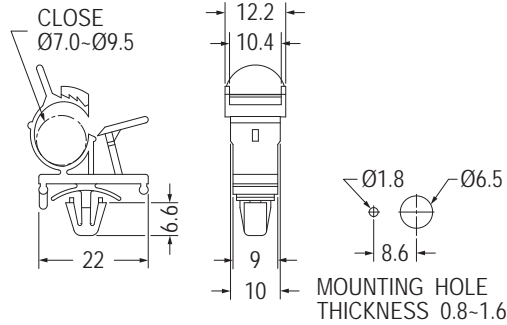

Part No.	Package
AWK-10	2000

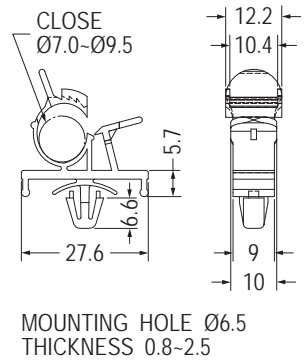

Part No.	Package
AWK-16	1000

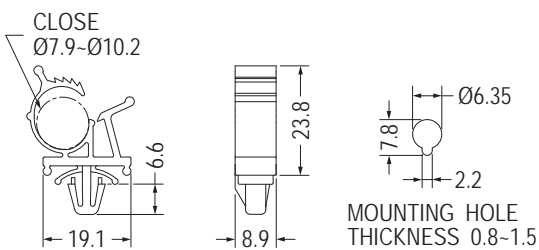

Part No.	Package
AWKA-2	500

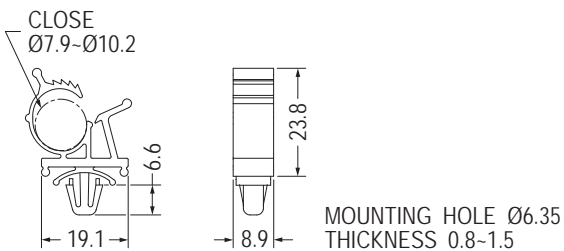
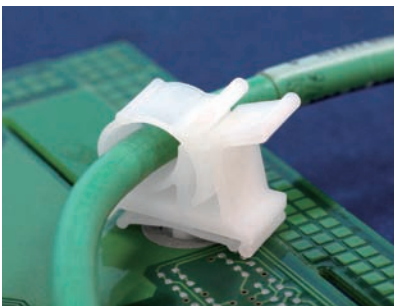

Part No.	Package
AWKA-1	500

電線固定座 CABLE CLAMP

用途：固定電線於PC板或機板上，維修方便，不佔空間。



- Material: Nylon 66 (UL)
- Flame Class: 94V-2/94V-0
- Color: Natural/Black/Gray
- Unit: mm

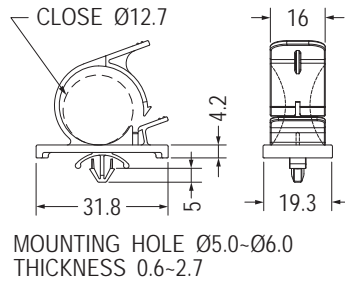

Part No.	Package
FWK-5	1000

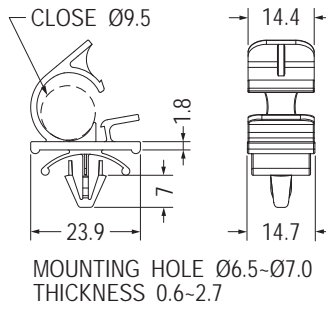
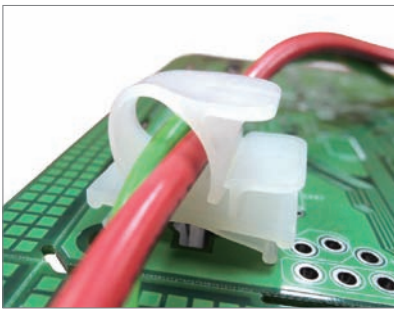

Part No.	Package
FWKA-1	250

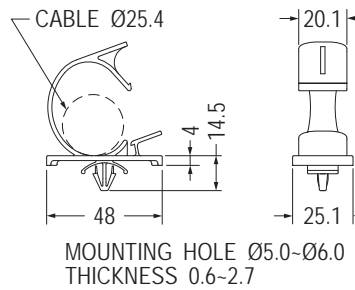
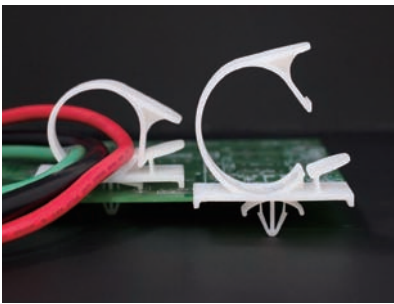

Part No.	Package
FWK-9	1000

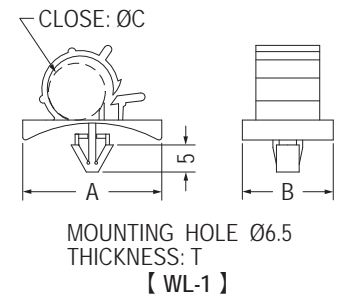
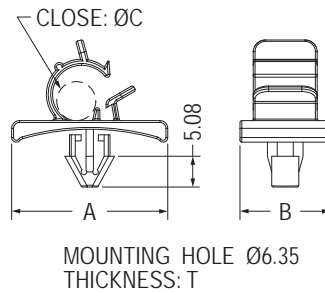

Part No.	A	B	C	T	Package
WL-1	25.7	16.8	10.5	0.8~1.6	500
WL-2	35.05	22.35	19.05	0.5~2.0	100
WL-3	25.4	14.73	6.35	2.3~3.8	500
WL-4	25.4	16.51	9.52	2.3~3.8	

電源線固定座 POWER CORD RETENTION CLAMP

用途：可固定電源線，避免不小心脫落，造成電腦停機。

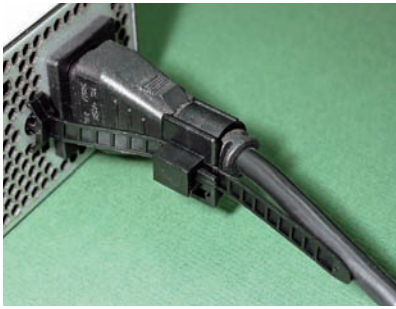

- Material: Nylon 66 (UL)
- Flame Class: 94V-2/94V-0
- Color: Black
- Unit: mm

MOUNTING HOLE: ØG
THICKNESS: T

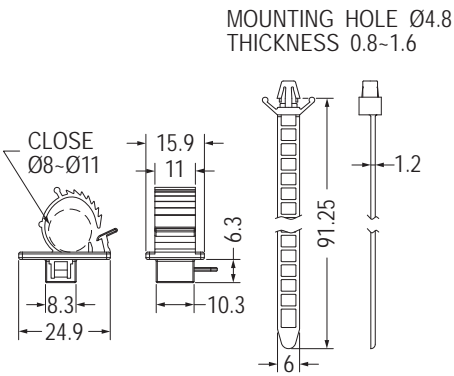

Part No.	Package
SWPL-14	100

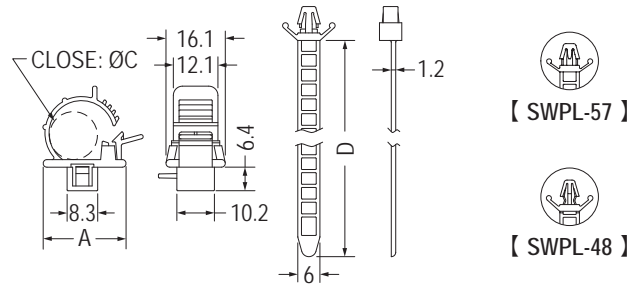

Part No.	A	C	D	G	T	Package
SWPL-1	22.5	11.0~13.0	86.75	4.8	0.8~2.0	100
SWPL-4	22.5	12.0~15.0	86.75	4.8	0.8~2.0	
SWPL-6	22.5	11.0~13.0	86.75	3.5	0.8~2.0	
SWPL-8	29.5	19.0~22.0	86.75	4.8	0.8~2.0	
SWPL-48	22.5	11.0~13.0	86.75	4.0	0.8~2.0	
SWPL-57	22.5	12.0~15.0	86.75	4.8	0.6~1.8	
SWPL-74	22.5	11.0~13.0	112.5	4.8	0.8~2.0	

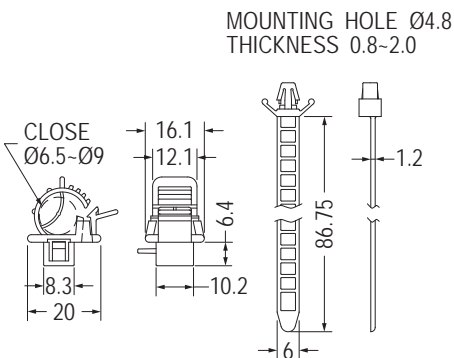

Part No.	Package
SWPL-3	100

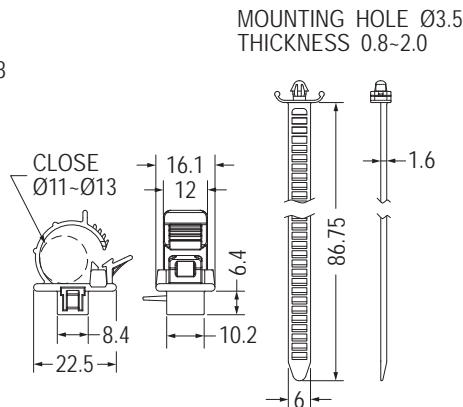

Part No.	Package
SWPL-53	100

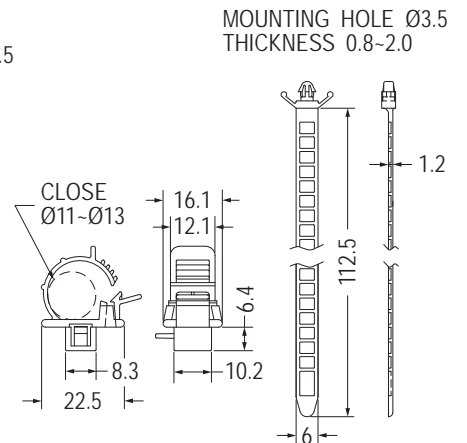

Part No.	Package
SWPL-22	100

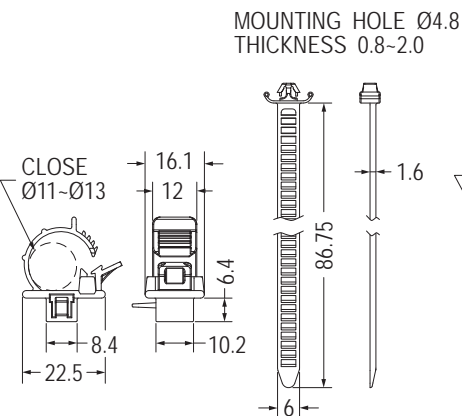

Part No.	Package
SWPL-25	100

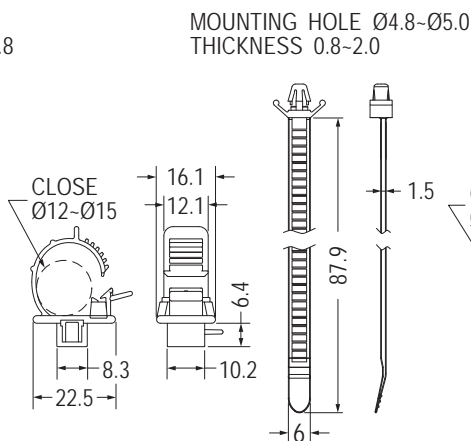

Part No.	Package
SWPL-58	100

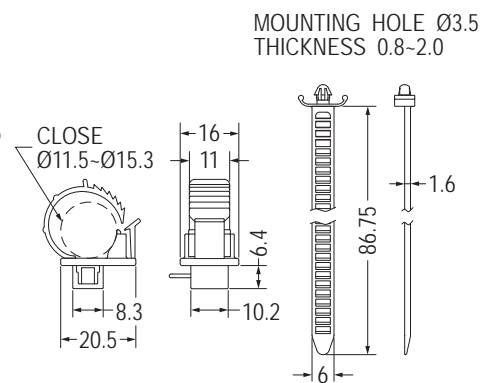

Part No.	Package
SWPL-67	100

電源線固定座 POWER CORD RETENTION CLAMP

用途：可固定電源線，避免不小心脫落，造成電腦停機。

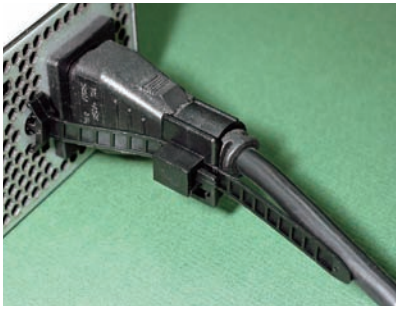

- Material: Nylon 66 (UL)
- Flame Class: 94V-2/94V-0
- Color: Black
- Unit: mm

MOUNTING HOLE Ø5.0
THICKNESS 0.5-2.0

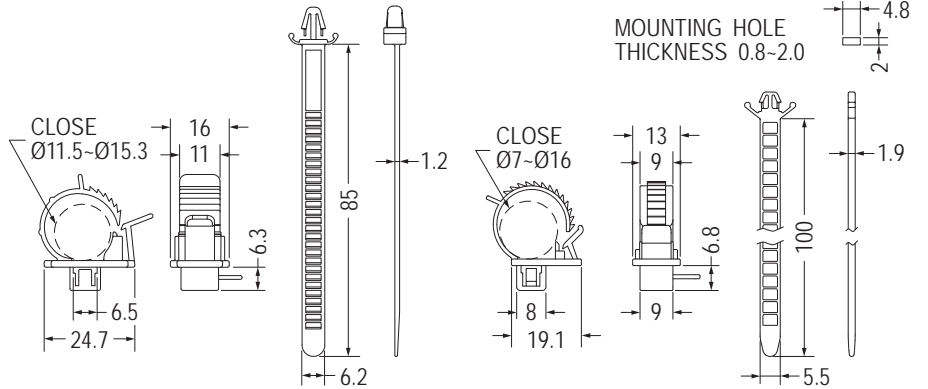

Part No.	Package
SWPL-65	100

Part No.	Package
SWPL-100	100

MOUNTING HOLE THICKNESS 0.8-1.4

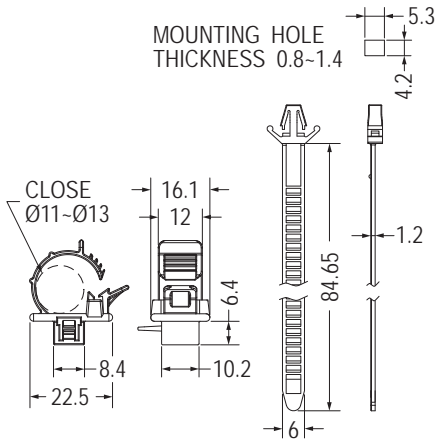

Part No.	Package
SWPL-73	100

MOUNTING HOLE THICKNESS 0.8

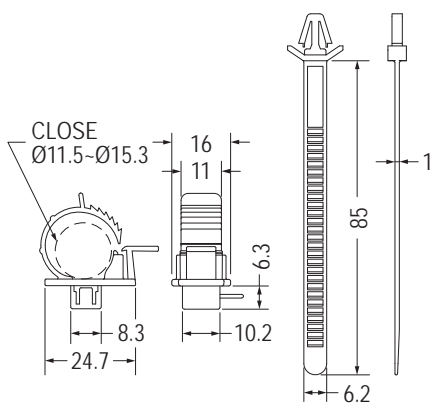

Part No.	Package
SWPL-96	100

MOUNTING HOLE: ØG
THICKNESS: T

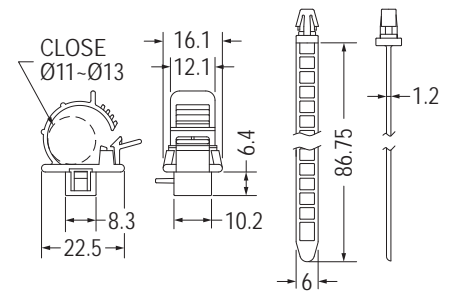

Part No.	G	T	Package
SWPL-2	4.8	2.0-3.0	100
SWPL-11	4.0	0.6-0.8	
SWPL-27	4.8	0.6-1.2	

MOUNTING HOLE Ø3.5
THICKNESS 0.8

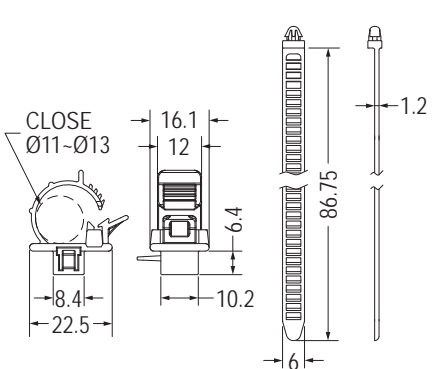

Part No.	Package
SWPL-66	100

MOUNTING HOLE Ø4.0
THICKNESS 0.6-1.0

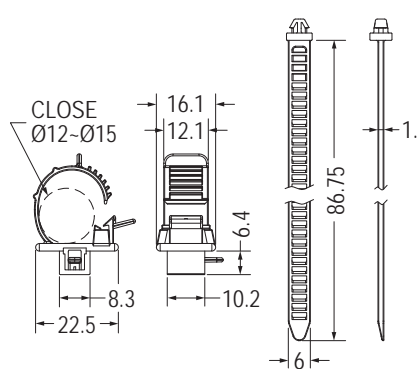

Part No.	Package
SWPL-88	100

MOUNTING HOLE Ø4.0
THICKNESS 0.6-0.8

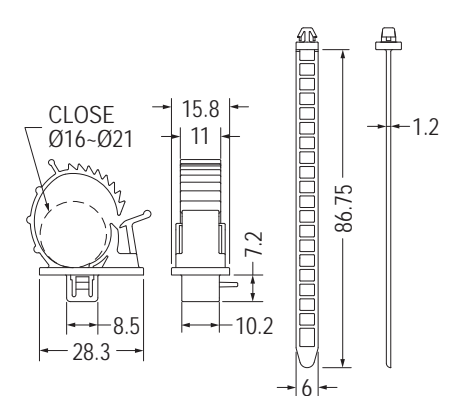

Part No.	Package
SWPL-103	100

電源線固定座 POWER CORD RETENTION CLAMP

用途：可固定電源線，避免不小心脫落，造成電腦停機。

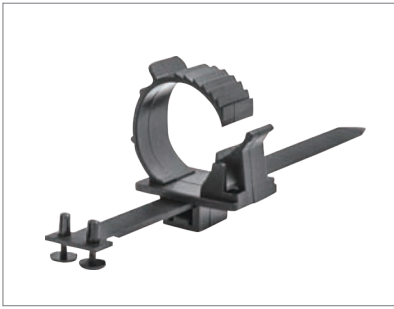

- Material: Nylon 66 (UL)
- Flame Class: 94V-2/94V-0
- Color: Black
- Unit: mm

MOUNTING HOLE: ØG
THICKNESS 1.8

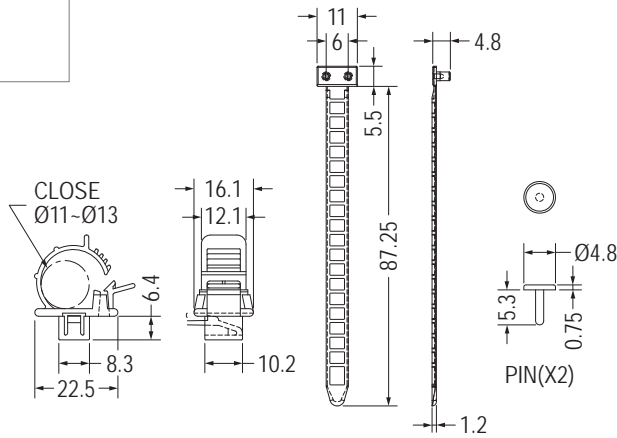

Part No.	G	Package
SWPL-37-1	2.5	100
SWPL-37S-1	2.3	

4

MOUNTING HOLE Ø3.5
THICKNESS 2.0-2.8

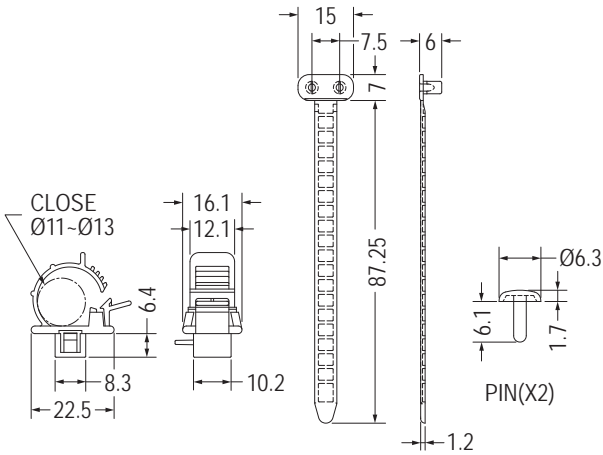

Part No.	Package
SWPL-76	100

MOUNTING HOLE Ø2.3
THICKNESS 1.8

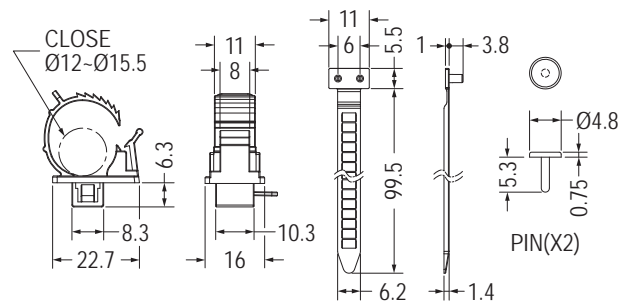

Part No.	Package
SWPL-94	100



MOUNTING HOLE Ø2.2
THICKNESS 0.8-1.0

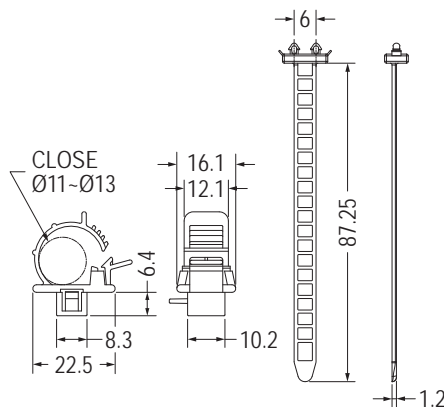

Part No.	Package
SWPL-15S	100

電源線固定座 POWER CORD RETENTION CLAMP

用途：可固定電源線，避免不小心脫落，造成電腦停機。

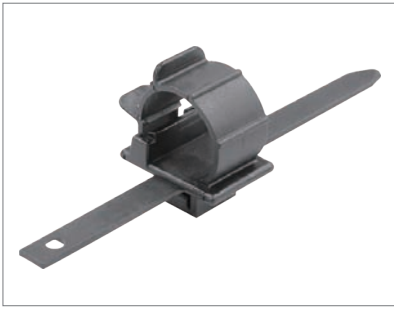

- Material: Nylon 66 (UL)
- Flame Class: 94V-2/94V-0
- Color: Black
- Unit: mm

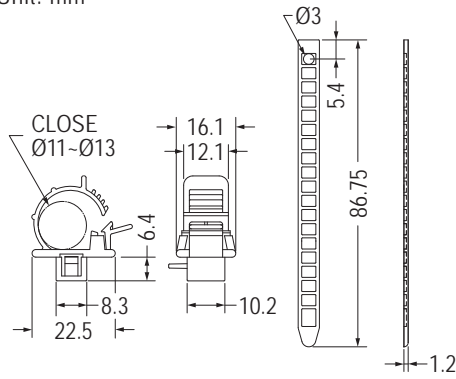

Part No.	Package
SWPL-19	100

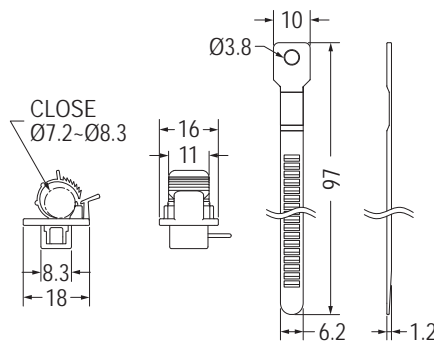

Part No.	Package
SWPL-72	100

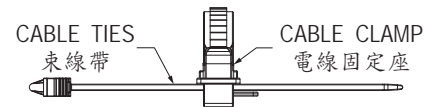
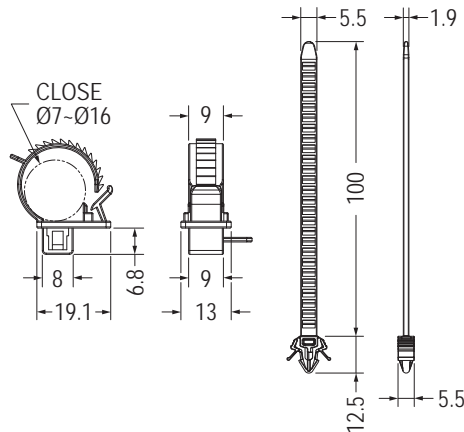
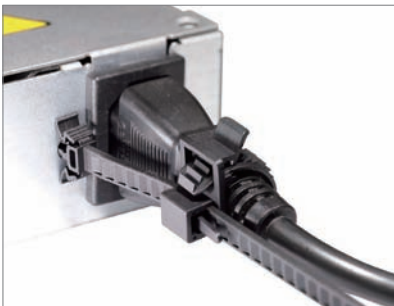

組裝示意圖
Assembly Diagram



• Patented (專利品)

Part No.	Package
SWPL-106	100

RECOMMEND MOUNTING HOLE Ø4.8
RECOMMEND THICKNESS 0.6~1.0

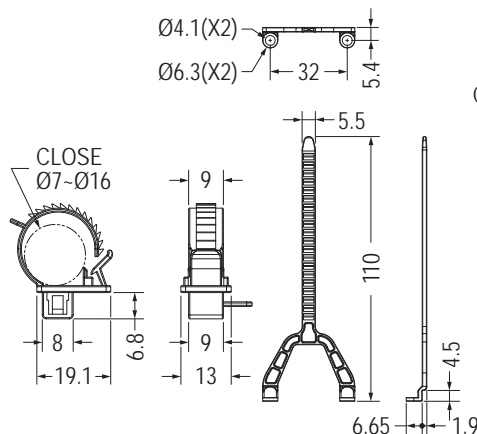
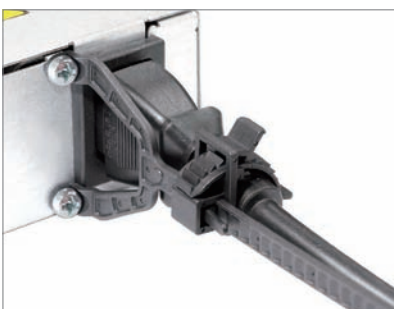

組裝示意圖
Assembly Diagram



Part No.	Package
SWPL-105	100

電源線固定座 POWER CORD RETENTION CLAMP

用途：可固定電源線，避免不小心脫落，造成電腦停機。

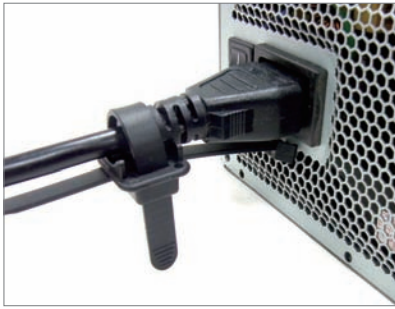

- Material: Nylon 66 (UL)
- Flame Class: 94V-2/94V-0
- Color: Black
- Unit: mm

MOUNTING HOLE Ø4.8
THICKNESS 0.8-2.0
CABLE Ø18.0
(DATA ONLY FOR REF.)

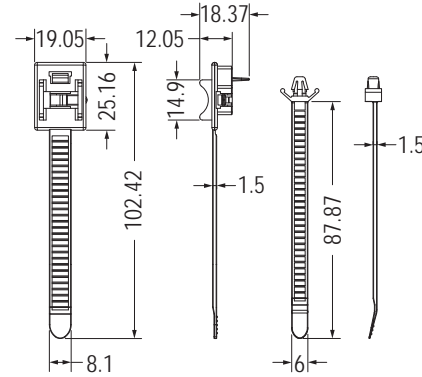

Part No.	Package
SWPL-16	500

MOUNTING HOLE Ø4.8
THICKNESS 0.8-2.0
CABLE Ø16.0
(DATA ONLY FOR REF.)

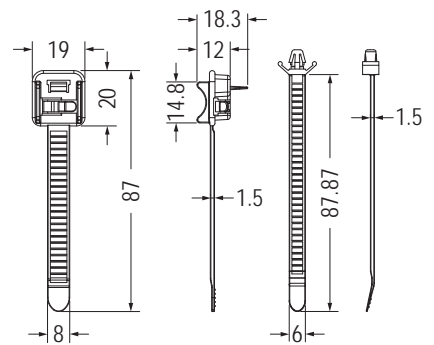

Part No.	Package
SWPL-21	500

4

MOUNTING HOLE Ø4.8
THICKNESS 0.8-2.0

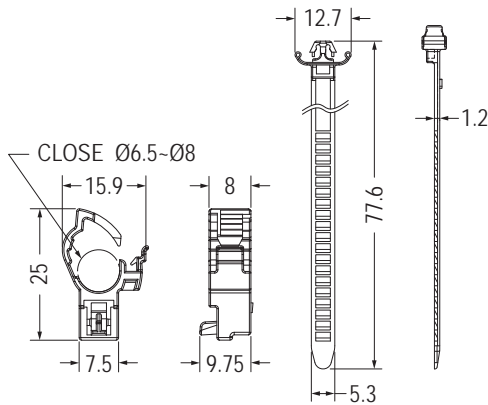

Part No.	Package
SWPL-18	100

MOUNTING HOLE Ø4.8
THICKNESS 0.8-2.0

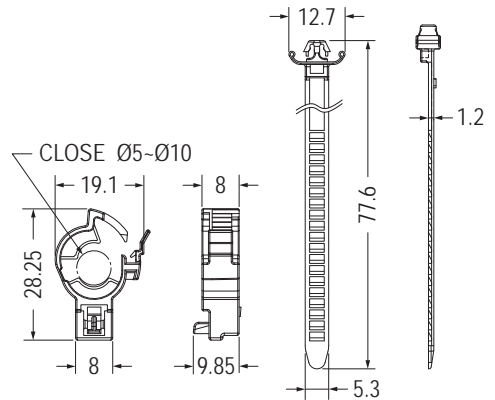

Part No.	Package
SWPL-20	100

• Patented (專利品)

MOUNTING HOLE
THICKNESS 1.8-2.8

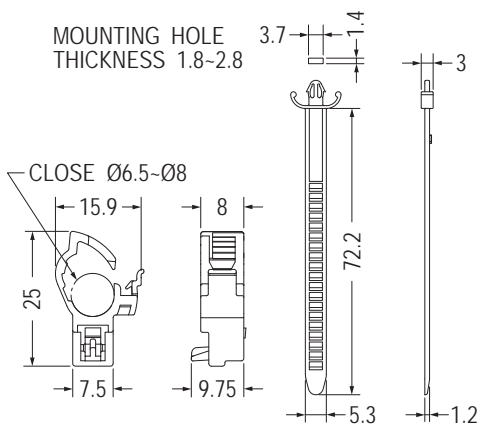

Part No.	Package
SWPL-69	100

MOUNTING HOLE Ø4.8
THICKNESS 0.8-2.0

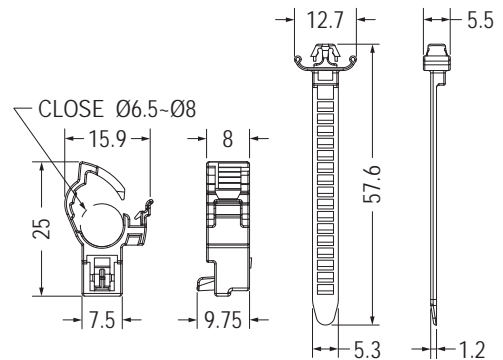

Part No.	Package
SWPL-82	500

電源線固定座 POWER CORD RETENTION CLAMP

用途：可固定電源線，避免不小心脫落，造成電腦停機。



- Material: Nylon 66 (UL)
- Flame Class: 94V-2/94V-0
- Color: Black
- Unit: mm

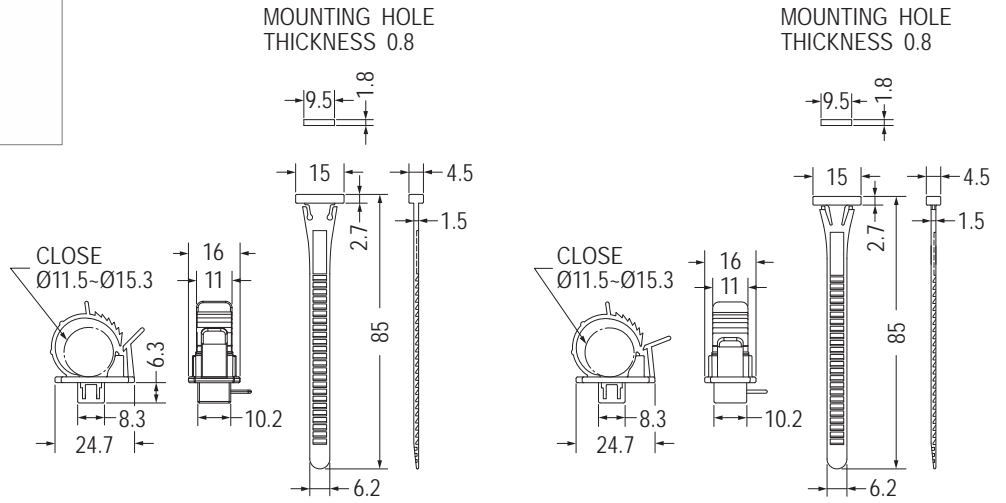

Part No.	Package
SWPL-23	100

Part No.	Package
SWPL-64	100

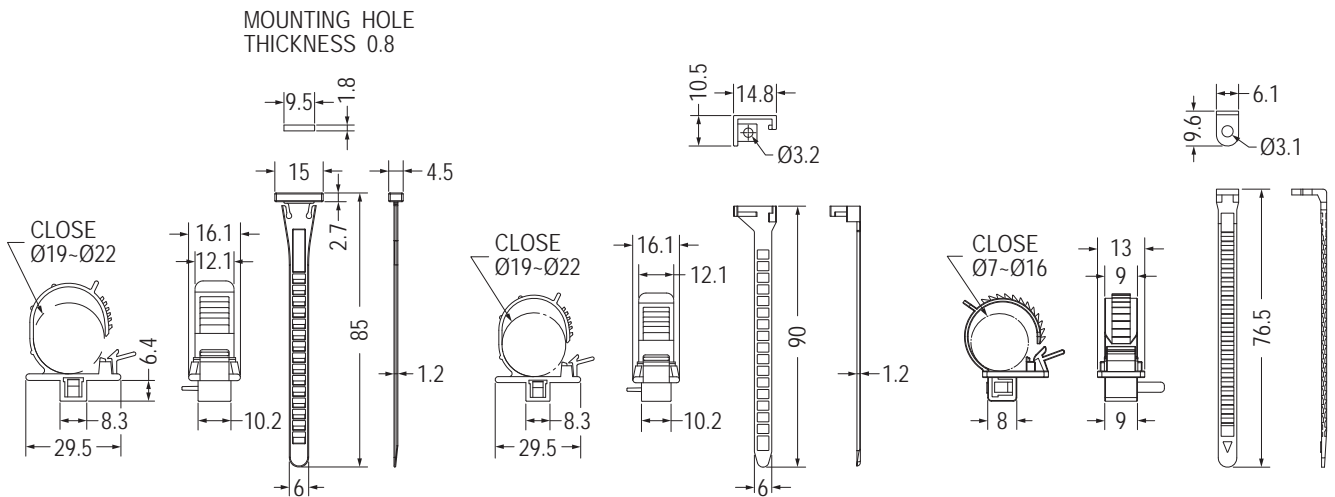

Part No.	Package
SWPL-101	100

Part No.	Package
SWPL-43	100

Part No.	Package
SWPL-78	100

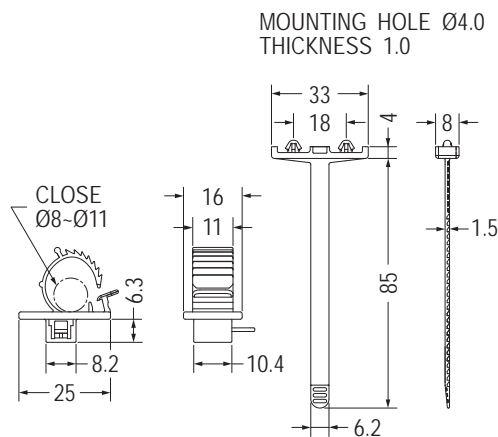

Part No.	Package
SWPL-46	100

電源線固定座 POWER CORD RETENTION CLAMP

用途：可固定電源線，避免不小心脫落，造成電腦停機。



- Material: Nylon 66 (UL)
- Flame Class: 94V-2/94V-0
- Color: Black
- Unit: mm

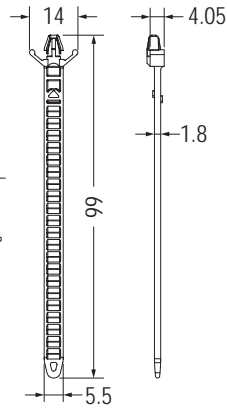
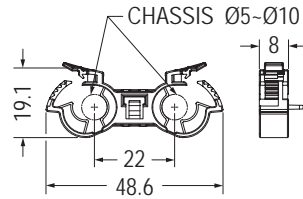

MOUNTING HOLE Ø4.0
THICKNESS 0.8-2.0

Part No.	Package
SWPL-87	100

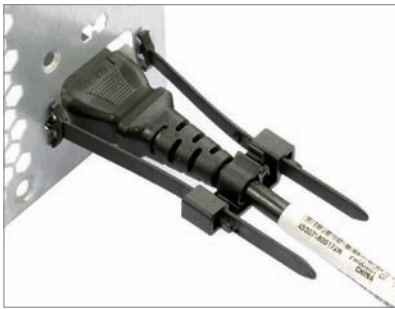

- Material: Nylon 66 (UL)
- Flame Class: 94V-2/94V-0
- Color: Black
- Unit: mm
- Patented (專利品)

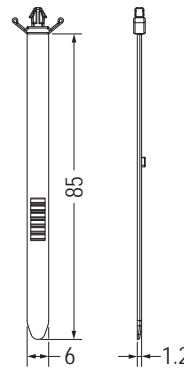
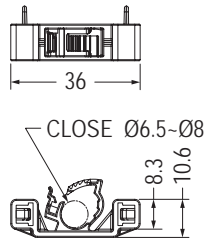

Ø3.5
MOUNTING HOLE
THICKNESS 0.8-2.0

Part No.	Package
SWPL-50	100

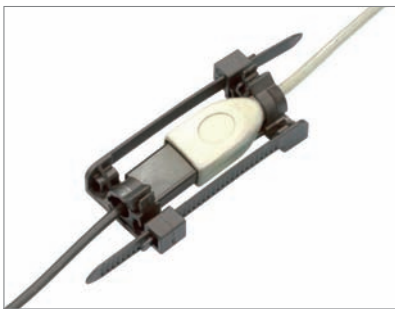

- Material: Nylon 66 (UL)
- Flame Class: 94V-2/94V-0
- Color: Black
- Unit: mm
- Patented (專利品)

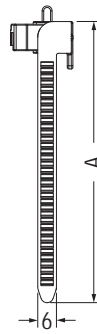
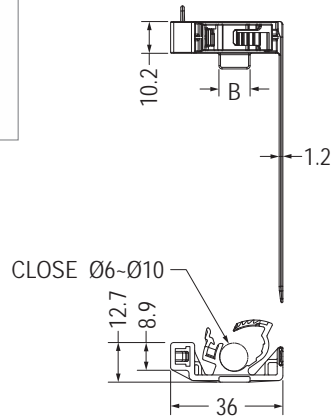

用途：固定電源線、USB...等，中間對接延長，避免脫落。

Part No.	A	B	Package
SWPL-52	90.2	10.0	100
SWPL-55	90.2		
SWPL-59	115.2	10.0	

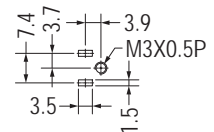
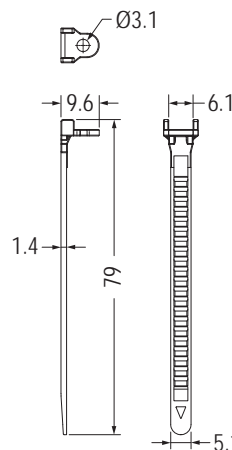
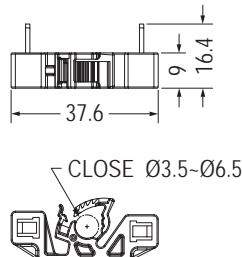

RECOMMEND MOUNTING LAYOUT

Part No.	Package
SWPL-98	100

電線插座固定座 POWER PLUG MOUNT

用途：避免電源插座脫落。

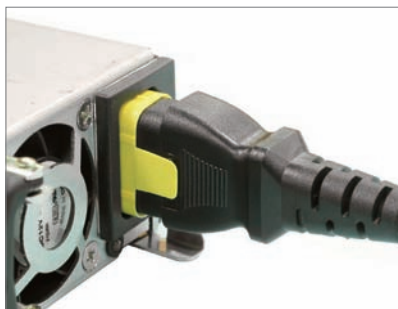

- Material: Nylon 66 (UL)
- Flame Class: 94V-2/94V-0
- Color: Natural/Black/Red/Blue/Yellow/Green
- Unit: mm

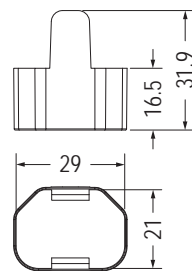
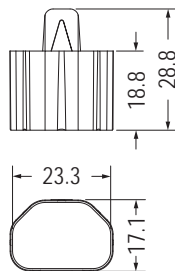

Part No.	Package
SWKL-1	1000

Part No.	Package
SWKL-2	1000

HDMI固定座 HDMI MOUNT

用途：配合螺絲、束線帶，使用於USB、HDMI等線材端子，固定於機殼上，避免勾到脫落。



- Material: Nylon 66 (UL)
- Flame Class: 94V-2/94V-0
- Color: Natural/Black
- Unit: mm

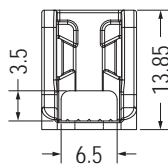

3.3mm FOR M3 SCREW

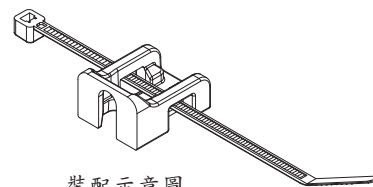
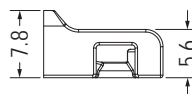
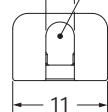

裝配示意圖
Assembly Diagram

Part No.	Package
SWCM-1	1000

束線帶固定座 CABLE TIE MOUNT

用途：固定於機板上，配合束線帶使用，固定電線。

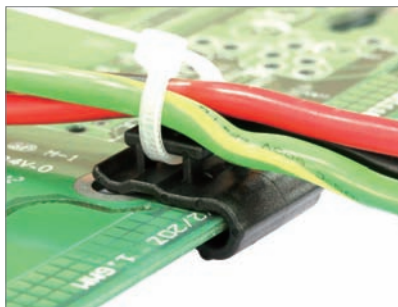

- Material: Nylon 66 (UL)
- Flame Class: 94V-2/94V-0
- Color: Natural/Black/Gray
- Unit: mm

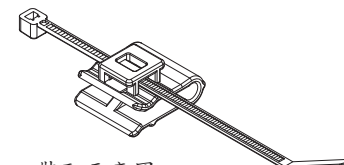
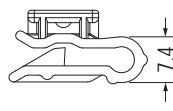
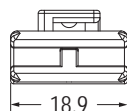
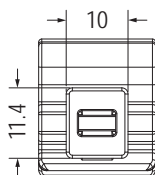

裝配示意圖
Assembly Diagram

Part No.	Package
SWPC-1	500

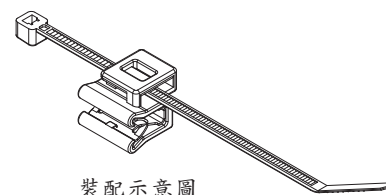
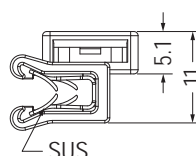
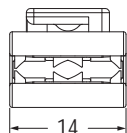
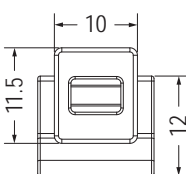
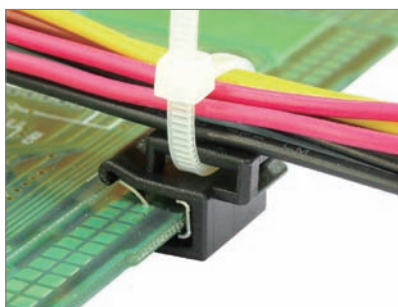

裝配示意圖
Assembly Diagram

Part No.	Package
SWPC-2	1000

RECOMMEND SUITABLE THICKNESS 1.5-2.0

電線固定座 U-CLAMP

用途：配合螺絲，固定電線，整齊美觀。

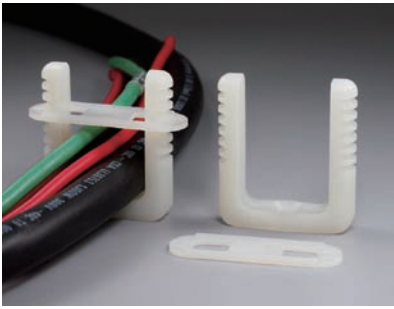

- Material: Nylon 66 (UL)
- Flame Class: 94V-2/94V-0
- Color: Natural/Black
- Unit: mm
- Patented (專利品)

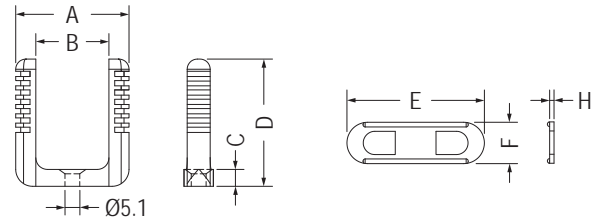

Part No.	A	B	C	D	E	F	H	Package
DC-1	38.9	25.1	5.8	43.7	47.2	14.2	1.5	100
DC-1.5	55.2	37.0	7.9	56.6	62.7	17.8	1.2	

電線固定座 WIRE SADDLE

用途：固定電線於機板上，維修方便，不佔空間。

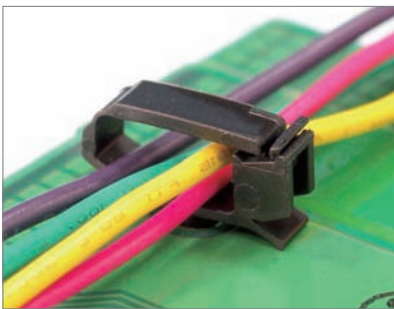

- Material: Nylon 66 (UL)
- Flame Class: 94V-2/94V-0
- Color: Natural/Black
- Unit: mm

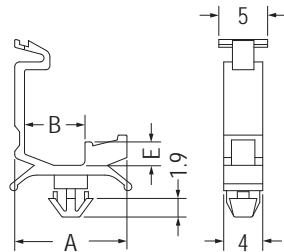

MOUNTING HOLE Ø3.5
THICKNESS: T

Part No.	A	B	E	T	Package
CHI-3	11.5	6.2	2.4	0.8-2.2	1000
CHI-6	16.5	11.0	4.5	0.5-1.8	

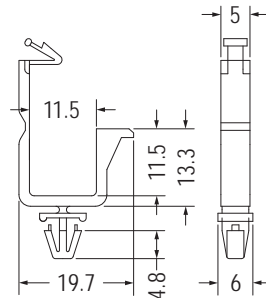
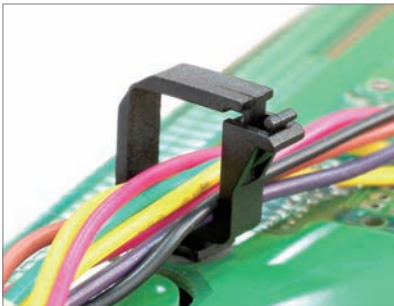

MOUNTING HOLE Ø4.8
THICKNESS 1.6

Part No.	Package
CHK-13	500

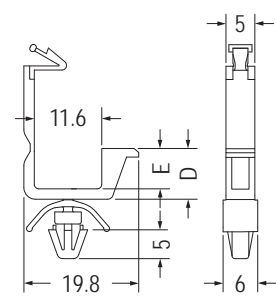

MOUNTING HOLE Ø4.8
THICKNESS 0.8-3.5

Part No.	D	E	Package
CHK-6	7.0	5.2	1000
CHK-8	8.8	7.0	
CHK-12	14.2	12.4	500

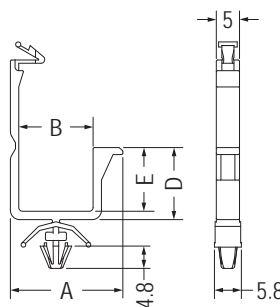
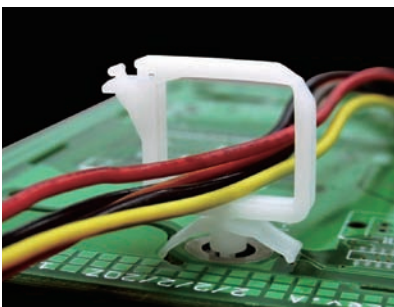

MOUNTING HOLE Ø4.8
THICKNESS 2.0-3.0

Part No.	A	B	D	E	Package
CHK-14	24.2	16.0	15.5	13.7	500
CHK-15	26.7	18.5	24.1	22.3	

電線固定座 WIRE SADDLE

用途：固定電線於PC板或機板上，維修方便，不佔空間。

- Material: Nylon 66 (UL)
- Flame Class: 94V-2/94V-0
- Color: Natural/Black
- Unit: mm

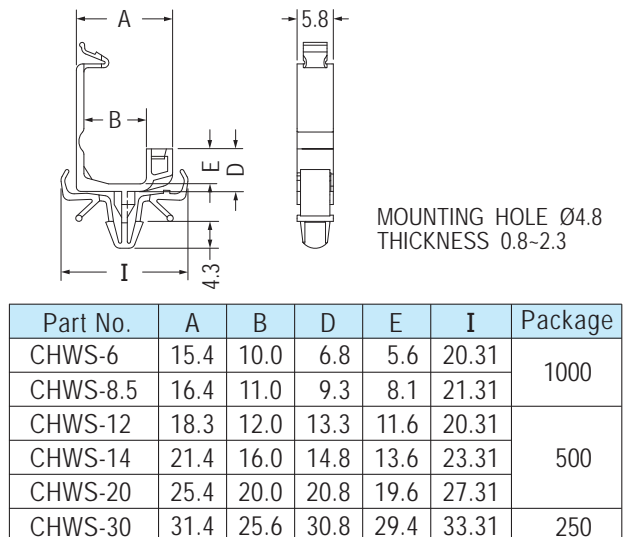
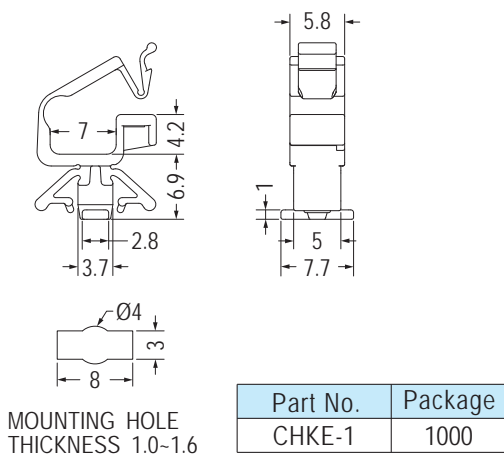
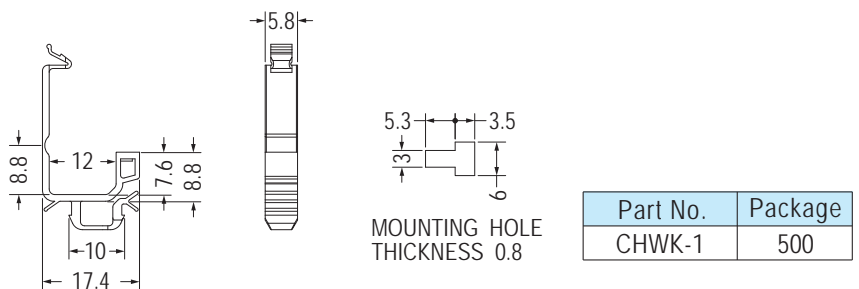
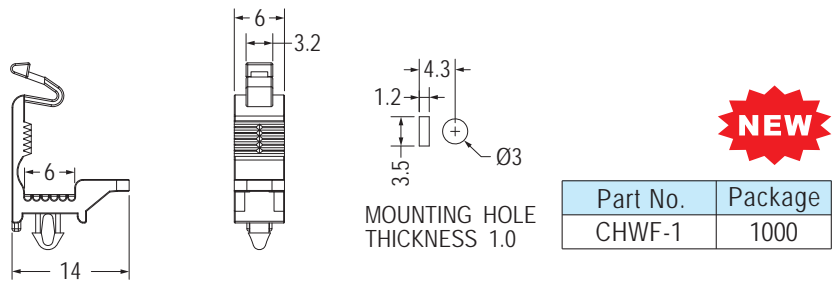
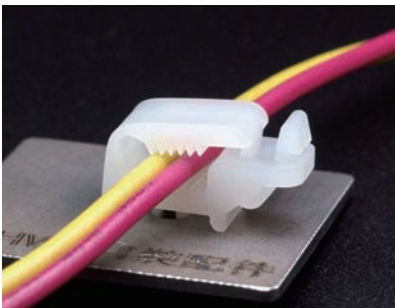
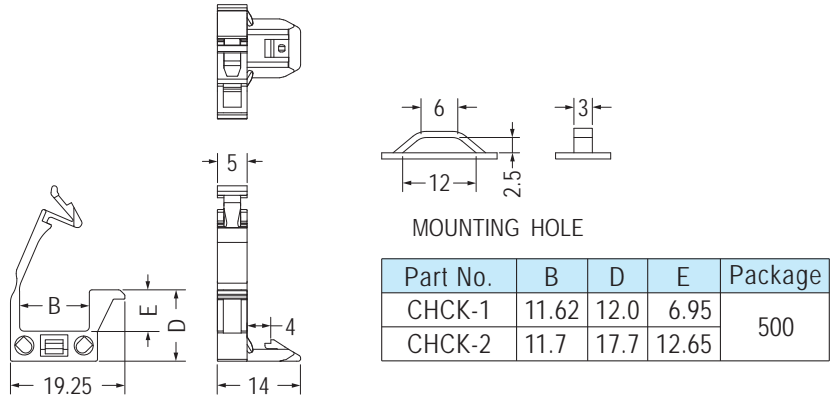
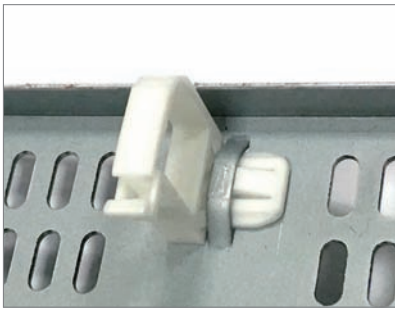
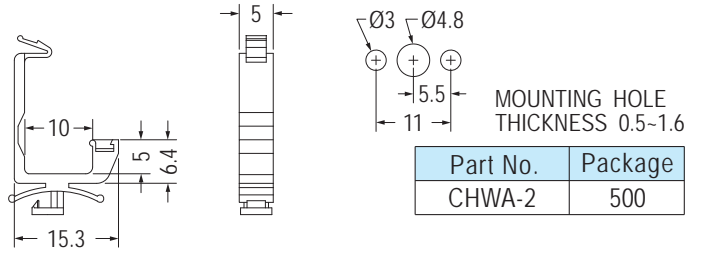
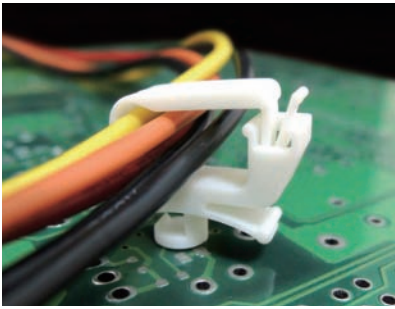

電線固定座 WIRE SADDLE

用途：固定電線於PC板或機板上，維修方便，不佔空間。

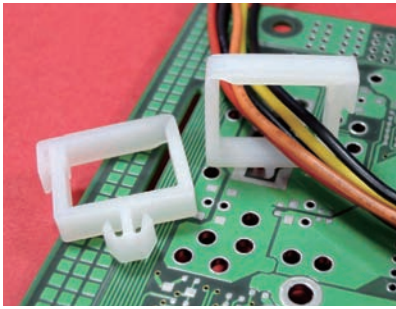

- Material: Nylon 66 (UL)
- Flame Class: 94V-2/94V-0
- Color: Natural/Black
- Unit: mm

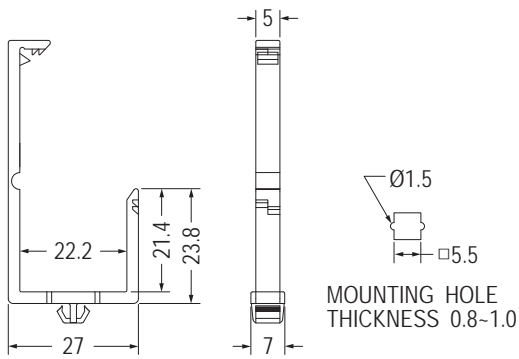

Part No.	Package
CHAC-4	500

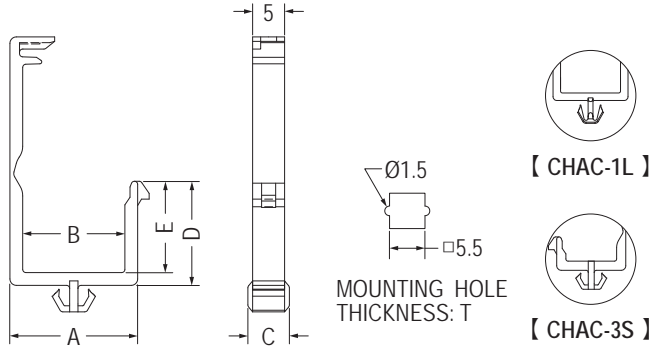

Part No.	A	B	C	D	E	T	Package
CHAC-1	20.0	16.0	6.8	16.3	14.3	1.0	1000
CHAC-1L	20.0	16.0	6.7	16.3	14.3	2.0	
CHAC-2	15.1	11.1	6.8	12.5	10.5	1.0	
CHAC-3	15.1	11.1	6.8	7.3	5.3	1.0	
CHAC-3S	15.1	11.1	6.5	7.3	5.3	1.0	

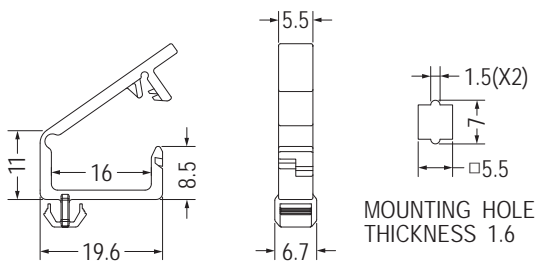

Part No.	Package
CHAC-8	1000

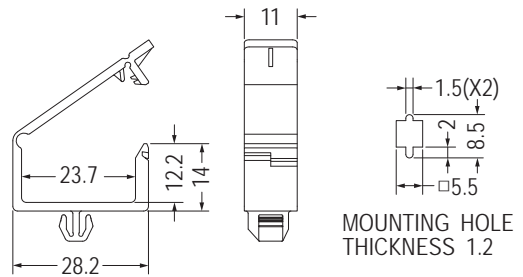

Part No.	Package
CHAC-7	1000

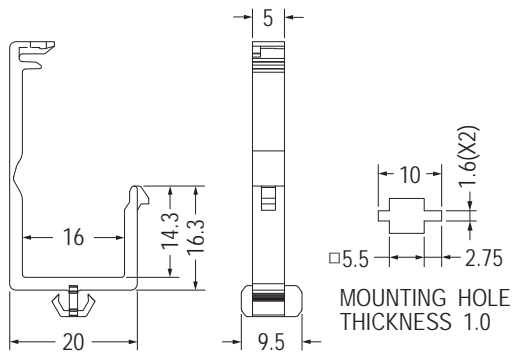

Part No.	Package
CHAC-5-1	1000

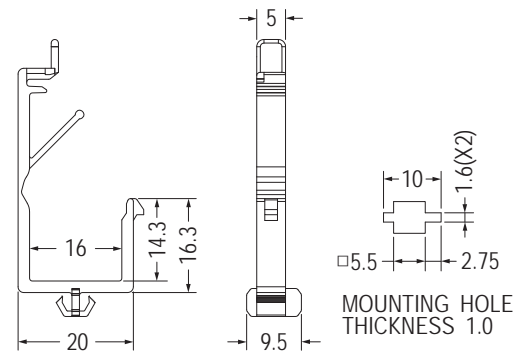

Part No.	Package
CHACA-1	1000

電線固定座 WIRE SADDLE

用途：固定電線於PC板或機板上，維修方便，不佔空間。

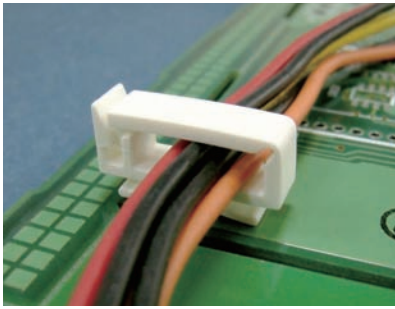

- Material: Nylon 66 (UL)
- Flame Class: 94V-2/94V-0
- Color: Natural/Black
- Unit: mm

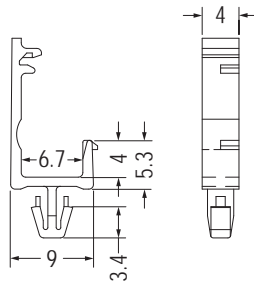

MOUNTING HOLE Ø3.0
THICKNESS 1.2-1.7

Part No.	Package
CHL-3	1000

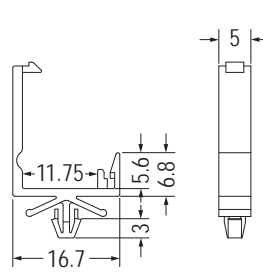

MOUNTING HOLE Ø3.5
THICKNESS 0.8-2.0

Part No.	Package
CHJ-3	1000

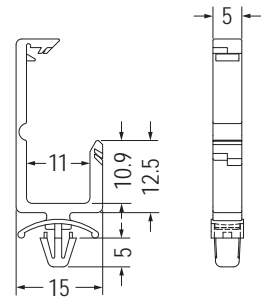

MOUNTING HOLE Ø4.8
THICKNESS 0.8-2.0

Part No.	Package
CH-1	500

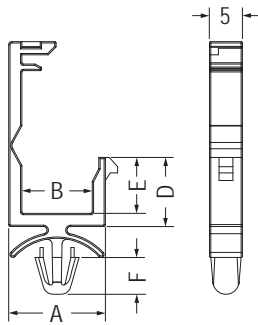

MOUNTING HOLE: ØG
THICKNESS: T

Part No.	A	B	D	E	F	G	T	Package
CHWT-3.4S	17.5	13.5	5.1	3.1	3.0	3.5	1.8	1000
CHWT-3.4	17.5	13.5	5.1	3.1	5.6	4.8	2.0	
CHWT-4.8	14.7	10.7	6.5	4.5	5.6	4.8	2.0	
CHWT-8.8	14.7	10.7	10.5	8.5	5.6	4.8	2.0	500
CHWT-10	20.3	16.3	11.7	9.7	5.6	4.8	2.0	
CHWT-14.1	20.3	16.3	15.8	13.8	5.6	4.8	2.0	
CHWT-21.7	22.0	18.0	23.4	21.4	5.6	4.8	2.0	

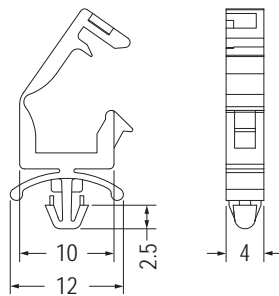
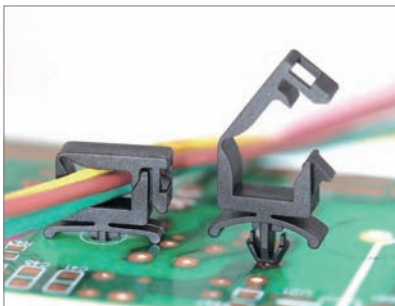

MOUNTING HOLE Ø3.5
THICKNESS 0.8-2.5

Part No.	Package
CHWH-4.4	500

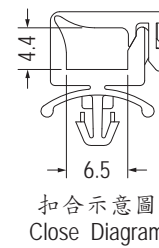

扣合示意圖
Close Diagram

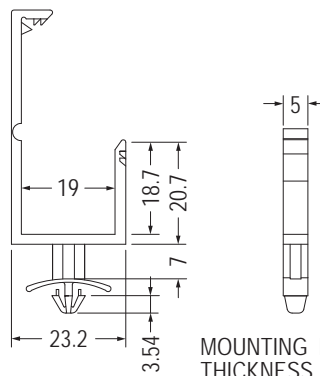

MOUNTING HOLE Ø4.8
THICKNESS 0.8-1.6

Part No.	Package
CHH-3	500

電線固定座 WIRE SADDLE

用途：固定電線於PC板或機板上，維修方便，不佔空間。

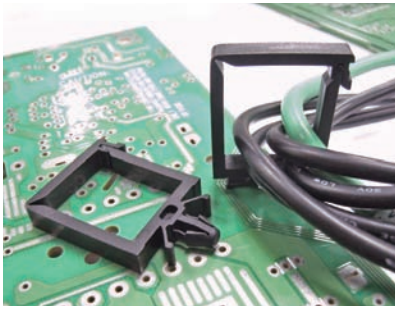

- Material: Nylon 66 (UL)
- Flame Class: 94V-2/94V-0
- Color: Natural/Black
- Unit: mm

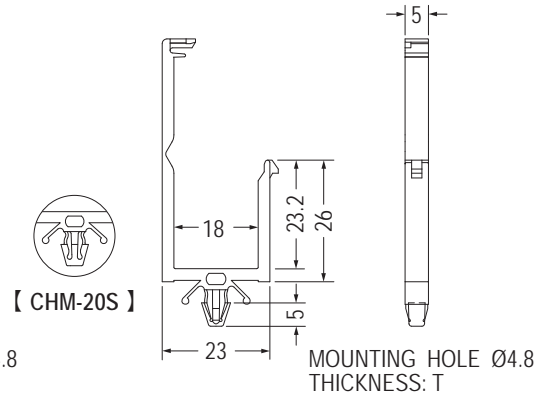
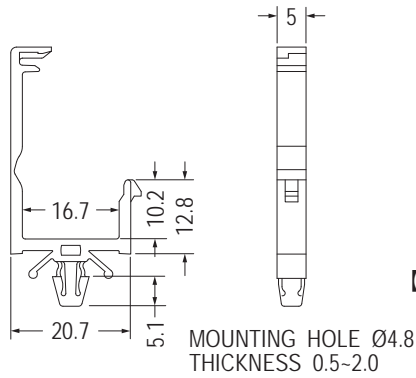

Part No.	Package
CHM-10	1000

Part No.	T	Package
CHM-20	0.5~2.0	500
CHM-20S	0.8~2.0	

4

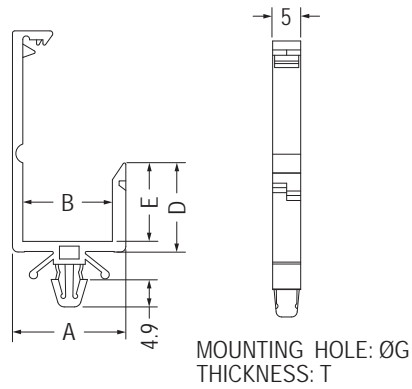
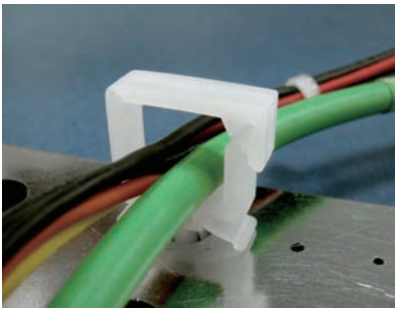

Part No.	A	B	D	E	G	T	Package	UL
CHC-1	20.25	16.0	15.9	14.0	4.8-5.0	1.2-2.4	500	UL
CHC-2	15.35	11.1	11.8	9.9	4.8-5.0	1.2-2.4		UL
CHC-3	15.35	11.1	6.8	4.9	4.8-5.0	1.2-2.4		UL
CHC-5	27.0	22.8	14.85	12.85	4.8	0.5-1.0		

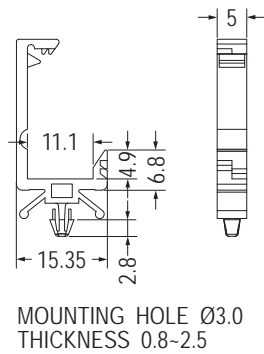
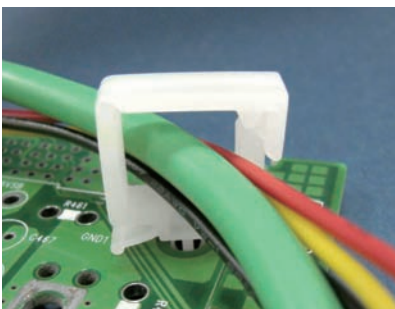

Part No.	Package
CHCS-1	500

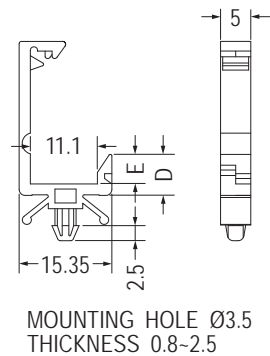

Part No.	D	E	Package
CHH-1	6.8	4.9	500
CHH-2	11.8	9.9	

電線固定座 WIRE SADDLE

用途：固定電線於PC板或機板上，維修方便，不佔空間。

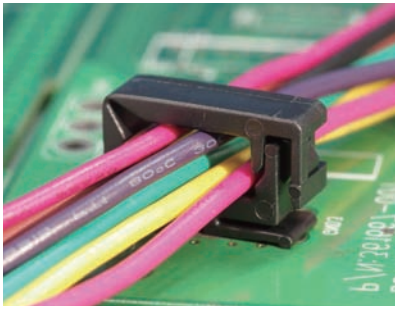

- Material: Nylon 66 (UL)
- Flame Class: 94V-2/94V-0
- Color: Natural/Black
- Unit: mm

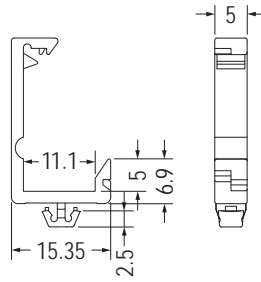

MOUNTING HOLE $\varnothing 4.8$
THICKNESS 1.0

Part No.	Package
CHC-4	500

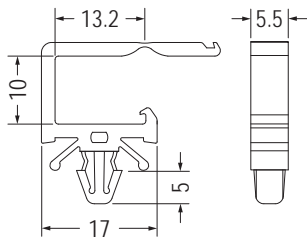

MOUNTING HOLE $\varnothing 4.8\text{-}\varnothing 5.0$
THICKNESS 1.2-2.4

Part No.	Package
CHC-6	1000

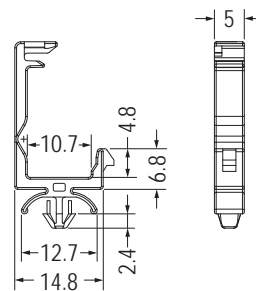

MOUNTING HOLE $\varnothing 4.0$
THICKNESS 0.8-2.5

Part No.	Package
CHZB-1	500

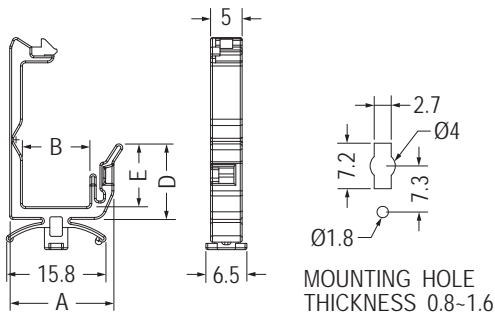

MOUNTING HOLE
THICKNESS 0.8-1.6

Part No.	A	B	D	E	Package
CHZ-1	16.5	10.7	11.95	9.95	500
CHZ-2	22.1	16.3	12.85	10.85	
CHZ-3	22.1	16.3	16.95	14.95	
CHZ-4	23.8	18.0	24.55	22.55	

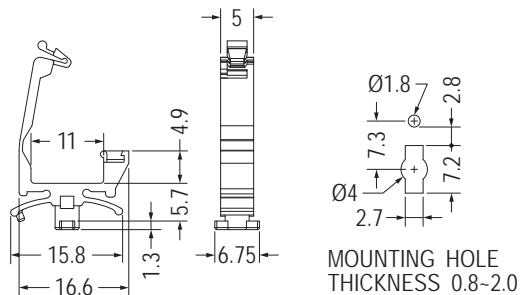

MOUNTING HOLE
THICKNESS 0.8-2.0

Part No.	Package
CHKA-1	1000

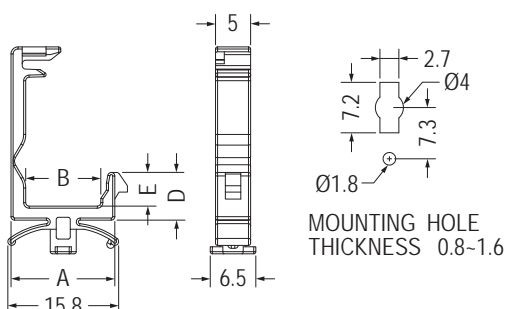

MOUNTING HOLE
THICKNESS 0.8-1.6



Part No.	A	B	D	E	Package
CHZA-1	14.8	10.7	6.8	4.8	1000
CHZA-1S	14.8	10.7	6.8	4.8	
CHZA-2	14.8	10.7	11.0	9.0	
CHZA-2S	14.8	10.7	11.0	9.0	
CHZA-3	20.4	16.3	11.9	9.9	500
CHZA-3S	20.4	16.3	11.9	9.9	
CHZA-4	20.4	16.3	16.0	14.0	
CHZA-4S	20.4	16.3	16.0	14.0	
CHZA-5	22.1	18.0	23.6	21.6	
CHZA-5S	22.1	18.0	23.6	21.6	

電線固定座 WIRE SADDLE

用途：固定電線於PC板或機板上，維修方便，不佔空間。

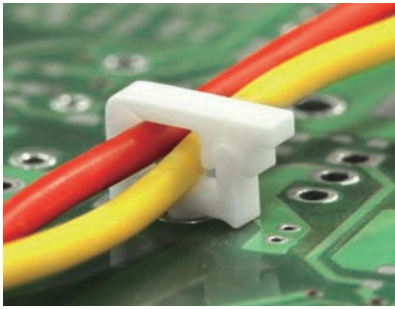

- Material: Nylon 66 (UL)
- Flame Class: 94V-2/94V-0
- Color: Natural/Black
- Unit: mm

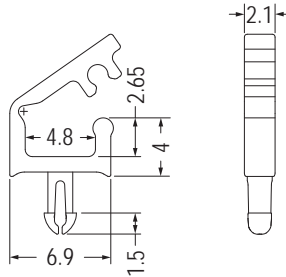

MOUNTING HOLE Ø1.7
THICKNESS 2.4

Part No.	Package
CHLB-1	1000

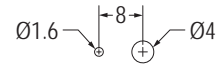
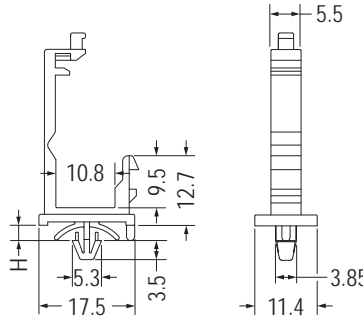
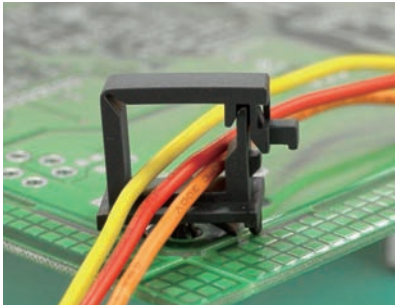

MOUNTING HOLE
THICKNESS: T

Part No.	H	T	Package
CHWE-1	2.79	1.6-2.0	1000
CHWE-1S	1.7	0.8-1.0	
CHWE-1M	2.0	0.8-1.0	

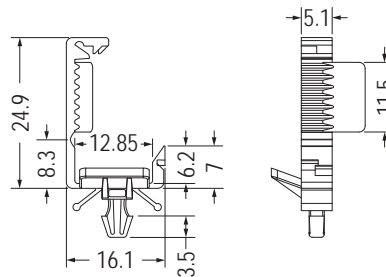
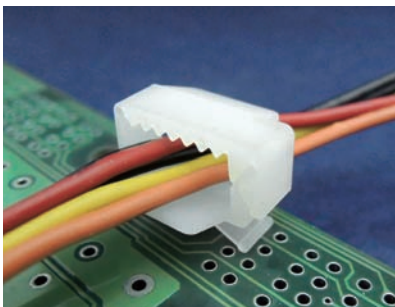

MOUNTING HOLE Ø3.5
THICKNESS 1.0-2.5

Part No.	Package
CHCA-1	500

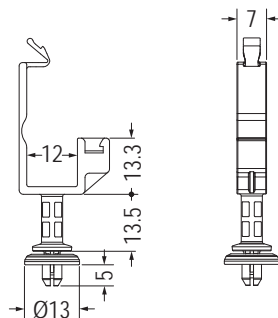

MOUNTING HOLE Ø4.6
THICKNESS 3.5

• Patented (專利品)

Part No.	Package
CHKC-1	1000



- Material: Nylon 66 (UL)
- Flame Class: 94V-2/94V-0
- Color: Natural/Black
- Unit: mm

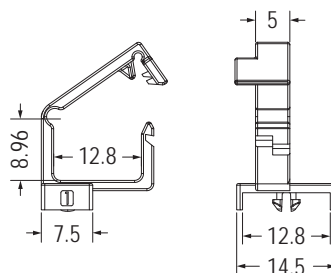

MOUNTING HOLE Ø3.0
THICKNESS 0.8



Part No.	Package
MIS-27	1000

電線固定座 WIRE SADDLE

用途：固定電線於PC板或機板上，維修方便，不佔空間。

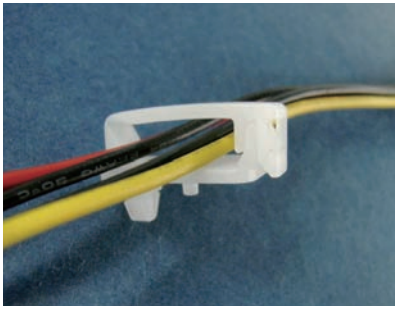

- Material: Nylon 66 (UL)
- Flame Class: 94V-2/94V-0
- Color: Natural/Black
- Unit: mm

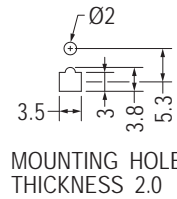
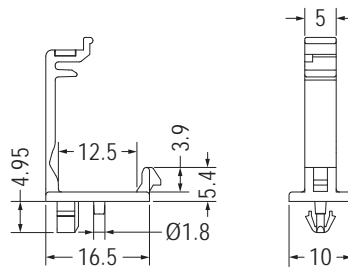

MOUNTING HOLE THICKNESS 2.0

Part No.	Package
CHMK-1	1000

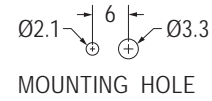
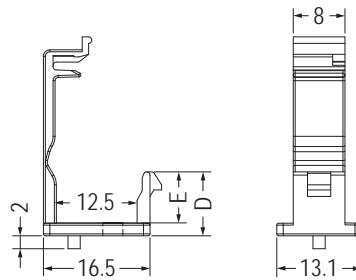
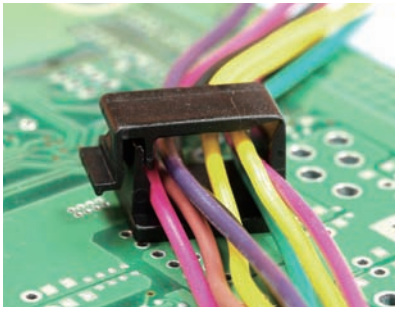

MOUNTING HOLE

Part No.	D	E	Package
CHMK-2	9.9	7.9	1000
CHMK-3	13.0	11.0	

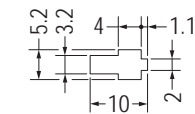
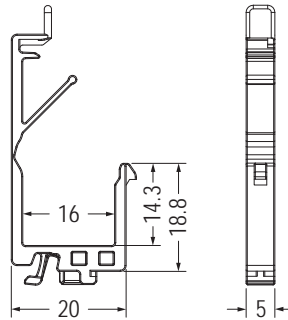
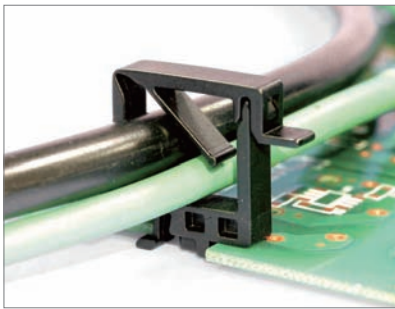

MOUNTING HOLE THICKNESS 0.6-0.8

Part No.	Package
CHACB-1	1000

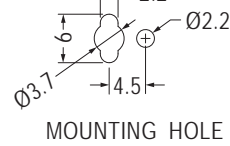
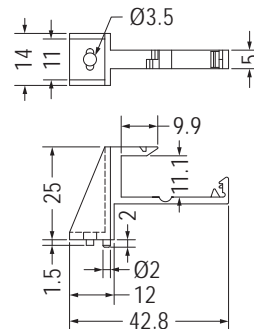
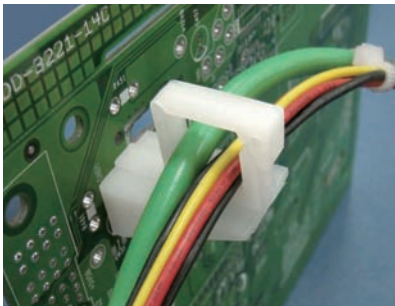

MOUNTING HOLE

Part No.	Package
CHW-1	250

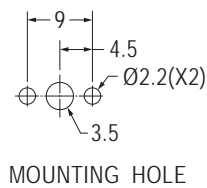
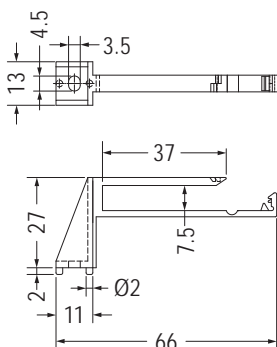

MOUNTING HOLE

Part No.	Package
CHW-2	250

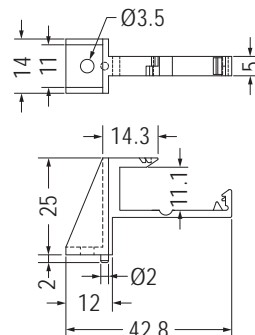

Part No.	Package
CHW-1T	250

電線固定座 WIRE MOUNT

用途：背膠式，固定電線，維修方便。

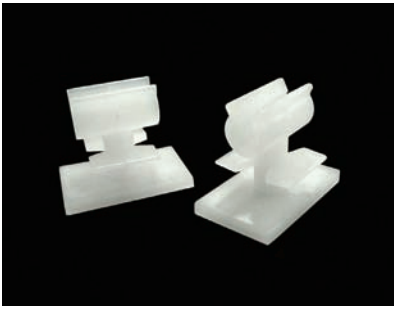

- Material: Nylon 66 (UL)
- Flame Class: 94V-2/94V-0
- Color: Natural/Black
- Unit: mm

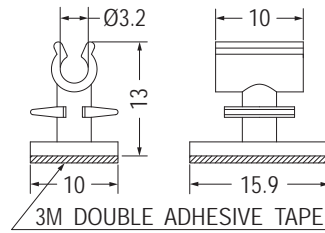

Part No.	Package
THVA-1	500

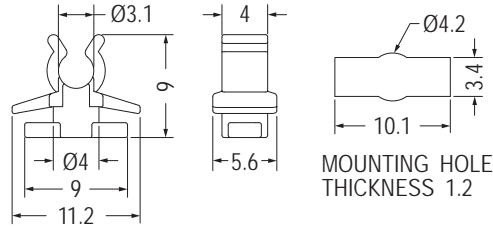

Part No.	Package
THVB-1	500

4



- Material: Nylon 66 (UL)
- Flame Class: 94V-2/94V-0
- Color: Natural/Black
- Unit: mm

用途：固定電線於PC板或機板上，維修方便，不佔空間。

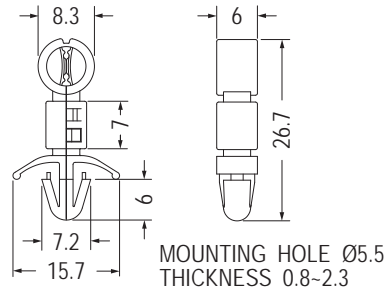

Part No.	Package
OCCSH-14	500

電線束線座 WIRE HOLDER

用途：固定電線於PC板或機板上，維修方便，不佔空間。



- Material: Nylon 66 (UL)
- Flame Class: 94V-2/94V-0
- Color: Natural/Black
- Unit: mm

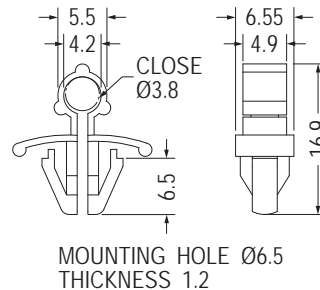

Part No.	Package
OCC-4	500

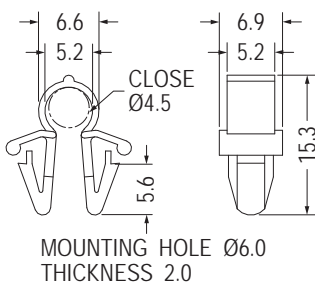

Part No.	Package
OCC-5	1000

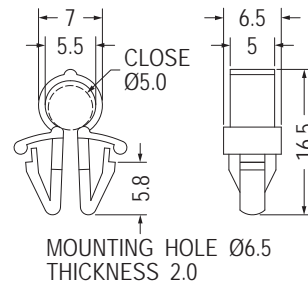

Part No.	Package
OCC6.5-5	1000

電線束線座 WIRE HOLDER

用途：固定電線於PC板或機板上，維修方便，不佔空間。

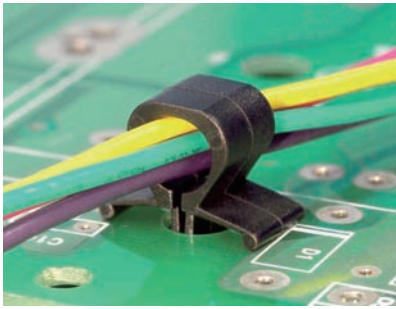

- Material: Nylon 66 (UL)
- Flame Class: 94V-2/94V-0
- Color: Natural/Black
- Unit: mm

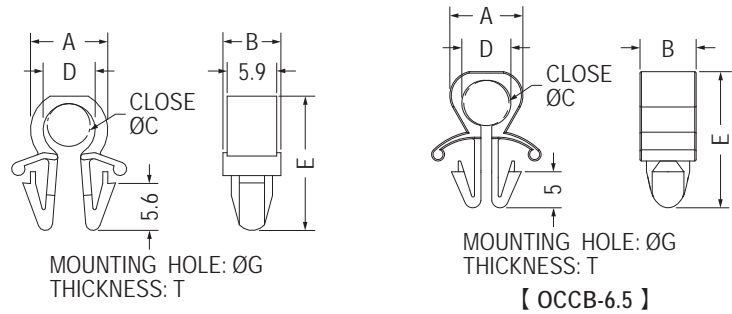

Part No.	A	B	C	D	E	G	T	Package
OCC-6	9.2	6.9	5.0	6.2	16.0	6.0	2.0	1000
OCCB-6.5	10.15	7.8	6.3	6.82	18.9	6.5	2.5-4.0	
OCC-8	11.2	6.9	7.0	8.2	17.6	6.0	2.0	500
OCC-10	13.2	6.9	9.0	10.2	20.1	6.0	2.0	

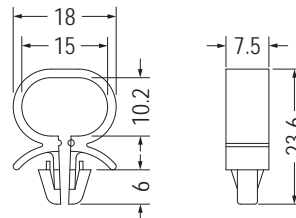

MOUNTING HOLE $\varnothing 6.0-\varnothing 6.5$
THICKNESS 0.8-2.5

Part No.	Package
OCCB-15	500

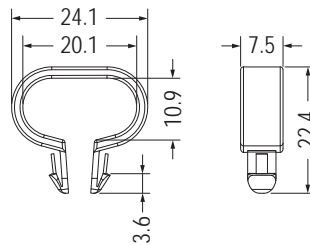

MOUNTING HOLE $\varnothing 6.5$
THICKNESS 3.5

Part No.	Package
OCCB-20	500

電線固定座 WIRE MOUNT

用途：固定電線於PC板或機板上，維修方便，不佔空間。

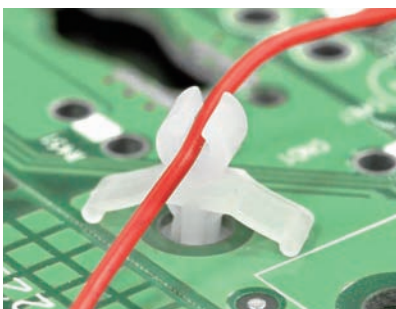

- Material: Nylon 66 (UL)
- Flame Class: 94V-2/94V-0
- Color: Natural/Black
- Unit: mm

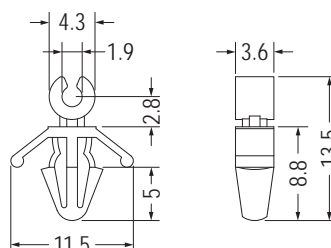

MOUNTING HOLE $\varnothing 4.0$
THICKNESS 0.8-2.5

Part No.	Package
THV-11	1000

電線固定座 WIRE MOUNT

用途：固定電線於PC板或機板上，維修方便，不佔空間。

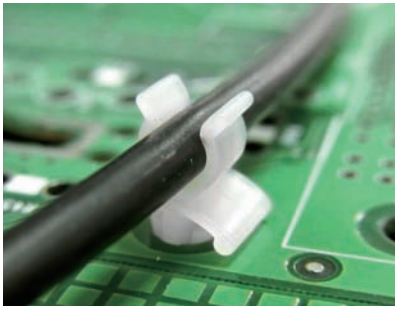

- Material: Nylon 66 (UL)
- Flame Class: 94V-2/94V-0
- Color: Natural/Black
- Unit: mm

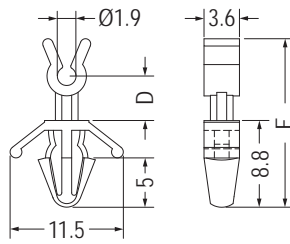

MOUNTING HOLE Ø4.0
THICKNESS 0.8-2.5

Part No.	D	E	Package
THV-1	4.5	17.1	500
THV-7	12.5	25.1	

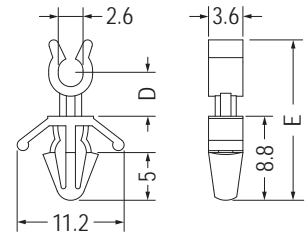

MOUNTING HOLE Ø4.0
THICKNESS 0.8-2.5

Part No.	D	E	Package
THV-3	4.6	16.8	500
THV-4	8.5	20.7	

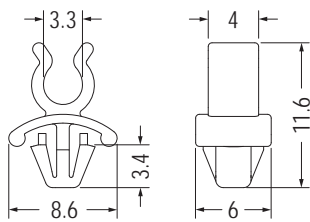

Part No.	Package
THV-6	1000

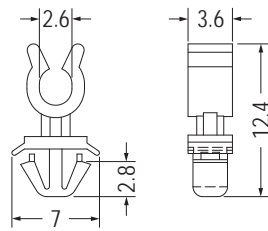

MOUNTING HOLE THICKNESS 0.6

Part No.	Package
THV-5	500

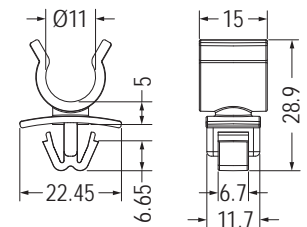

MOUNTING HOLE THICKNESS 3.0

Part No.	Package
THV-9	1000

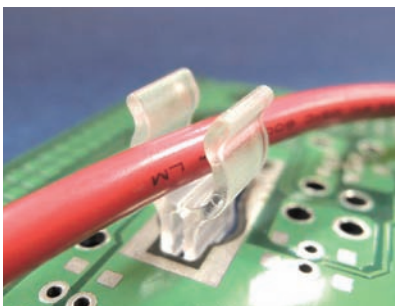

- Material: PC (UL)
- Flame Class: 94V-2
- Color: Transparent
- Unit: mm

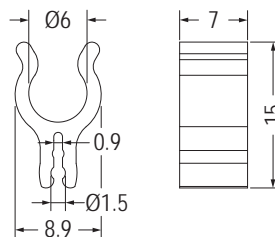

Part No.	Package
THVD-1	500

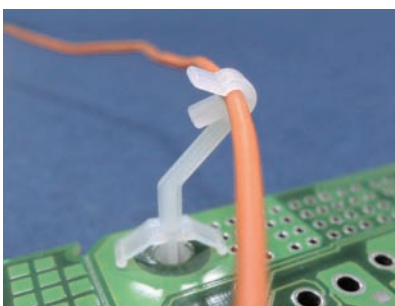

- Material: Nylon 66 (UL)
- Flame Class: 94V-2/94V-0
- Color: Natural/Black
- Unit: mm

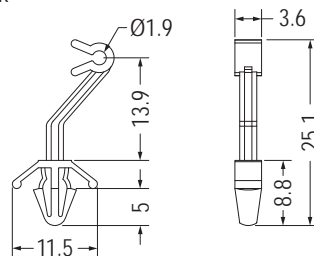

MOUNTING HOLE Ø4.0
THICKNESS 0.8-2.5

Part No.	Package
THV-8	1000

電線固定座 WIRE MOUNT

用途：固定電線於PC板或機板上，維修方便，不佔空間。

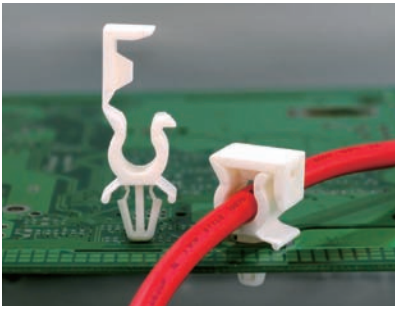

- Material: Nylon 66 (UL)
- Flame Class: 94V-2/94V-0
- Color: Natural/Black
- Unit: mm

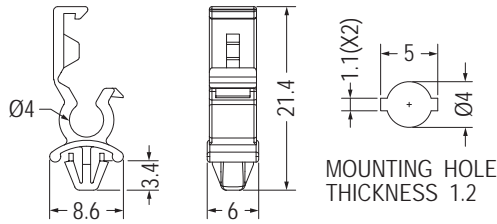

Part No.	Package
THV-14	1000

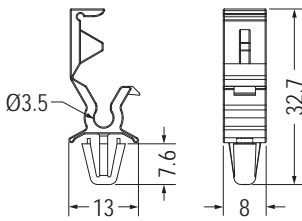

MOUNTING HOLE Ø6.0
THICKNESS 1.2

Part No.	Package
THV-17	1000

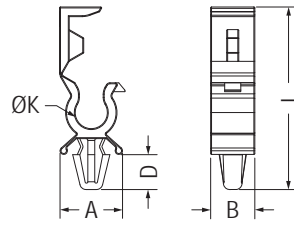

MOUNTING HOLE: ØG
THICKNESS 1.2

Part No.	A	B	D	G	K	L	Package
THV-15	13.6	9.63	7.6	6.0	7.0	39.8	1000
THV-16	11.5	3.6	5.0	4.0	1.9	21.23	

電線固定座 CABLE CLIP

用途：固定電線於PC板或機板上，維修方便，不佔空間。



- Material: Nylon 66 (UL)
- Flame Class: 94V-2/94V-0
- Color: Natural/Black
- Unit: mm

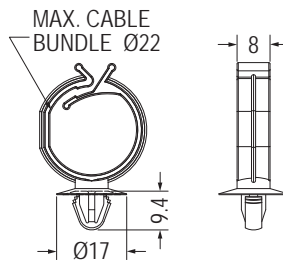

MOUNTING HOLE Ø6.5-Ø7.0
THICKNESS 0.6-2.0

Part No.	Package
THW-2	500

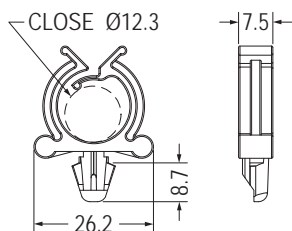

MOUNTING HOLE Ø6.35
THICKNESS 0.8-1.6

Part No.	Package
THW-1	500

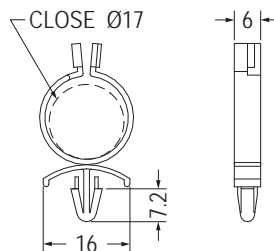

MOUNTING HOLE Ø4.8
THICKNESS 1.0-3.2

Part No.	Package
SLC-17	500

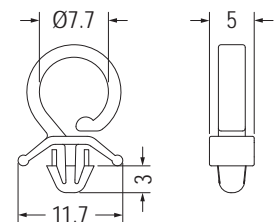

MOUNTING HOLE Ø4.0
THICKNESS 0.6-2.0

Part No.	Package
SLCB-8	1000

隔離束線座 STANDOFF CABLE CLIP

用途：固定冷陰極管或電線於PC板或機板上，維修方便，不佔空間。



- Material: Nylon 66 (UL)
- Flame Class: 94V-2/94V-0
- Color: Natural/Black
- Unit: mm

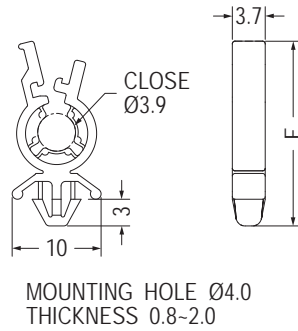

Part No.	E	Package
SLCPA-1	20.8	500
SLCPA-2	25.85	

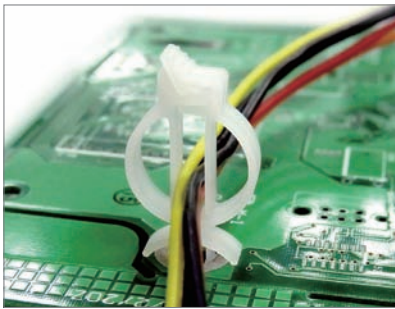

- Material: Nylon 66 (UL)
- Flame Class: 94V-2/94V-0
- Color: Natural/Black
- Unit: mm

用途：固定電線於PC板或機板上，強韌牢固，維修方便，不佔空間。

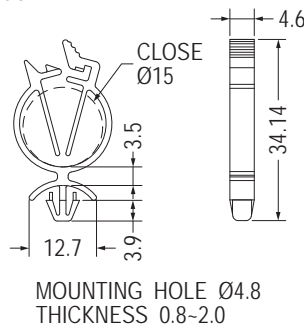

Part No.	Package
SLCA-15	500

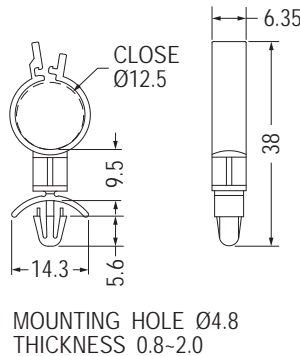

Part No.	Package
SLC-19	500

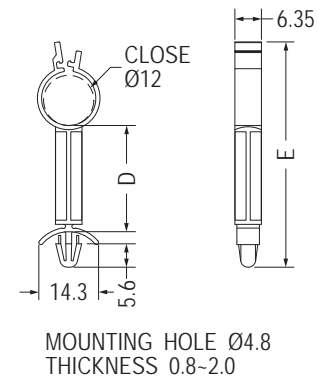

Part No.	D	E	Package
SLCC-12.7	12.7	41.2	500
SLCC-15.9	15.9	44.4	
SLCC-19.1	19.1	47.6	
SLCC-22.2	22.2	50.7	
SLCC-25.4	25.4	53.9	

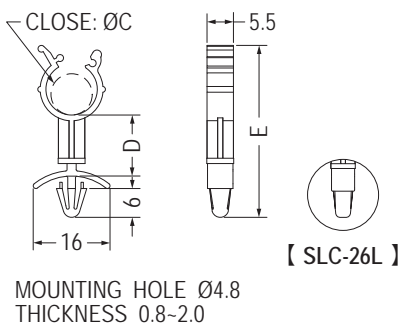

Part No.	C	D	E	Package
SLC-21	8.6	12.7	35.8	500
SLC-22	12.2	12.7	39.4	
SLC-24	8.6	6.4	29.5	
SLC-25	8.6	19.1	42.1	
SLC-26	6.7	19.1	39.3	
SLC-26L	6.7	19.1	39.3	

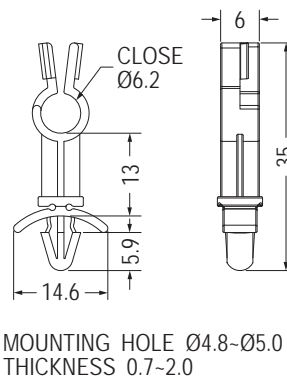

Part No.	Package
SLCE-13	500

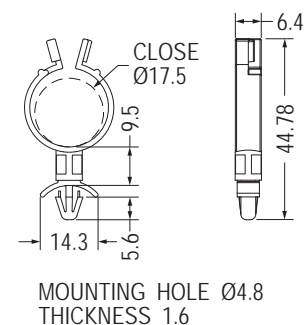

Part No.	Package
SLCD-9.5	500

隔離束線座 STANDOFF CABLE CLIP

用途：固定電線於PC板或機板上，強韌牢固，維修方便，不佔空間。

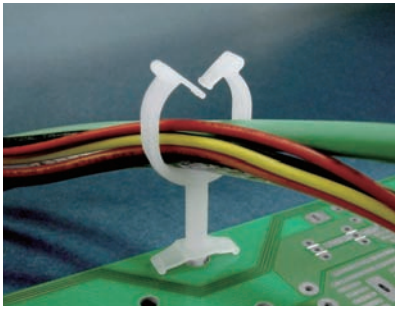

- Material: Nylon 66 (UL)
- Flame Class: 94V-2/94V-0
- Color: Natural/Black
- Unit: mm

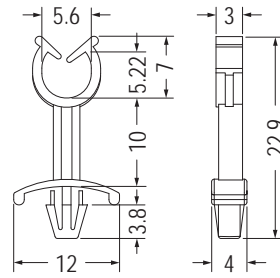

MOUNTING HOLE Ø3.5
THICKNESS 0.6-1.6

Part No.	Package
THE-11	500

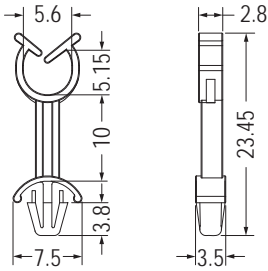

MOUNTING HOLE Ø3.5
THICKNESS 1.2-2.0

Part No.	Package
THE-39	500

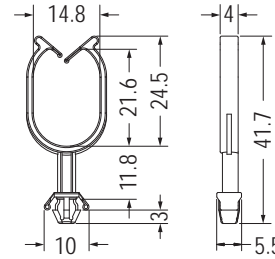

MOUNTING HOLE Ø4.8-Ø5.0
THICKNESS 0.5-2.0

Part No.	Package
THE-38	500

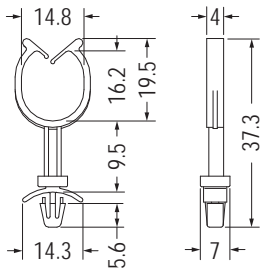

MOUNTING HOLE Ø4.8-Ø5.0
THICKNESS 0.5-2.3

Part No.	Package
THE-9	500

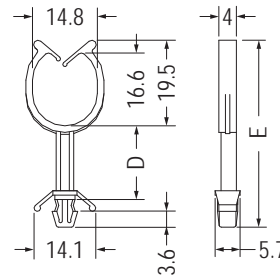

MOUNTING HOLE Ø4.8-Ø5.0
THICKNESS 0.5-2.3

Part No.	D	E	Package
THE-12	12.7	38.5	500
THE-17	16.8	42.6	
THE-25	25.0	50.8	
THE-37	36.8	62.6	



扭式固定座 TWIST LOCK

用途：可快速捆紮及解開電線，安裝容易。

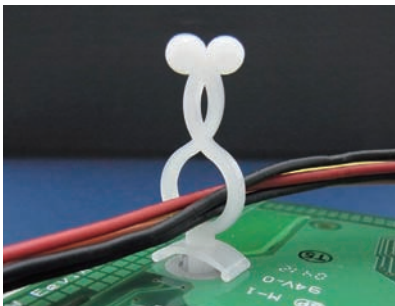

- Material: Nylon 66 (UL)
- Flame Class: 94V-2/94V-0
- Color: Natural/Black
- Unit: mm

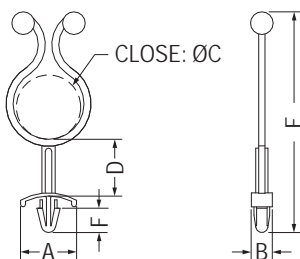

MOUNTING HOLE: ØG
THICKNESS: T

Part No.	A	B	C	D	E	F	G	T	Package	UL
THA-1	16.1	6.0	6.1	3.1	33.8	7.3	4.8~5.0	0.8~3.0	1000	UL
THA-2	16.0	5.9	6.1	20.0	51.0	7.3	4.8~5.0	0.8~3.0	500	UL
THA-3	16.0	5.9	6.1	35.3	66.0	7.3	4.8~5.0	0.8~3.0		UL
THA-4	16.0	6.0	9.8	2.8	39.6	7.3	4.8~5.0	0.8~3.0	1000	UL
THA-5	16.0	6.0	9.8	20.0	56.8	7.3	4.8~5.0	0.8~3.0	500	UL
THA-6	16.2	5.9	9.8	35.2	71.5	7.3	4.8~5.0	0.8~3.0		UL
THA-7	16.0	5.9	13.8	3.0	42.0	7.3	4.8~5.0	0.8~3.0	1000	UL
THA-8	16.1	6.0	13.8	20.4	59.3	7.3	4.8~5.0	0.8~3.0	500	UL
THA-9	16.0	5.9	13.8	35.8	74.7	7.3	4.8~5.0	0.8~3.0		UL
THA-10	16.0	6.0	18.4	16.2	63.5	7.3	4.8~5.0	0.8~3.0		UL
THA-11	16.0	5.4	22.3	3.0	56.8	7.3	4.8~5.0	0.8~2.5		UL
THA-12	16.0	6.0	9.7	15.8	53.1	7.3	4.8~5.0	0.8~3.0		UL
THA-14	16.0	6.0	18.7	8.0	55.3	7.3	4.8~5.0	0.8~3.0		UL
THA-15	16.4	6.0	6.8	10.5	43.8	7.3	4.8~5.0	0.8~3.0		
THA-16	10.5	6.0	7.0	5.6	34.7	7.3	4.8~5.0	0.8~2.0		
THA-19	13.8	6.0	9.8	4.4	40.9	7.2	4.8~5.0	0.8~2.5		
THA-21	12.9	4.8	7.7	8.0	37.7	3.7	3.0	0.8~2.4	1000	
THA-22	15.5	4.9	18.5	8.1	58.2	5.8	3.5	1.0~2.0	500	

扭式固定座 TWIST LOCK

用途：可快速細紮及解開電線，安裝容易。

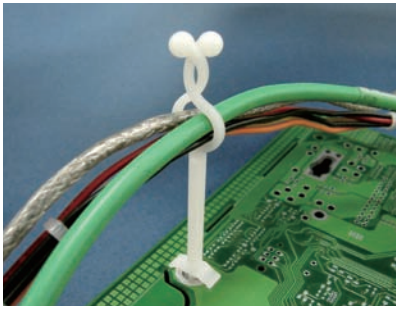

- Material: Nylon 66 (UL)
- Flame Class: 94V-2/94V-0
- Color: Natural/Black
- Unit: mm

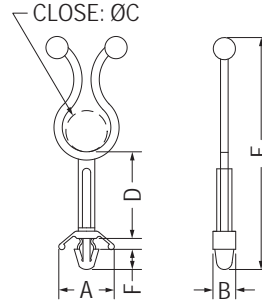

MOUNTING HOLE: ØG
THICKNESS 0.8-2.2

Part No.	A	B	C	D	E	F	G	Package
THC-1	13.8	5.5	10.4	21.0	56.5	5.0	4.8	500
THC-1S	9.2	4.9	7.2	3.0	26.7	3.1	4.0	1000
THC-2	13.8	5.6	5.0	34.0	59.8	5.0	4.8	500
THC-3	14.0	5.6	10.4	4.5	37.7	5.0	4.8	1000
THC-4	13.5	5.7	10.0	43.5	78.1	4.9	4.8	250

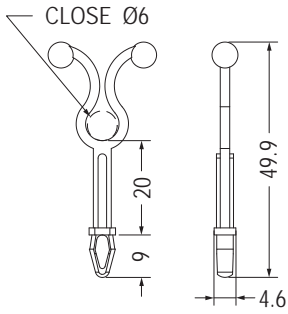

MOUNTING HOLE Ø4.6
THICKNESS 2.5

Part No.	Package
THN-1	500

4

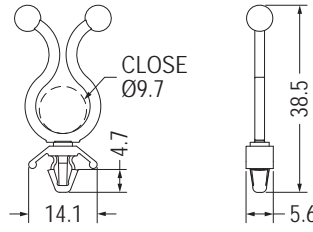
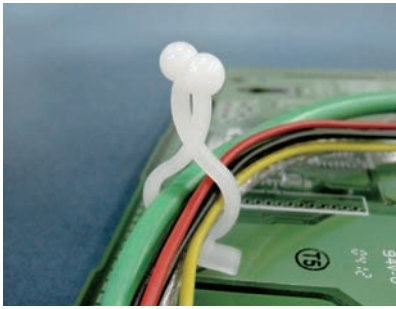

MOUNTING HOLE Ø4.8
THICKNESS 0.8-2.5

Part No.	Package
THC-6	1000

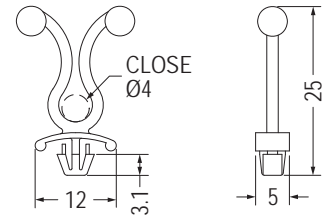

MOUNTING HOLE Ø4.0
THICKNESS 0.8-2.0

Part No.	Package
THC-5	1000

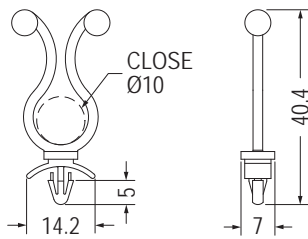

MOUNTING HOLE Ø4.0
THICKNESS 0.8-2.0

Part No.	Package
THI-4	500

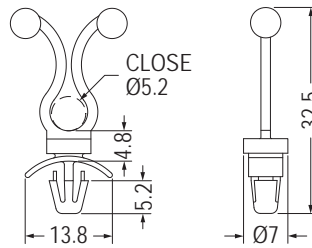

MOUNTING HOLE Ø4.8
THICKNESS 0.8-2.0

Part No.	Package
THL-4.8	1000

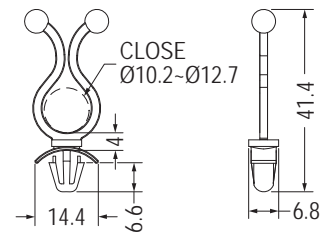

MOUNTING HOLE Ø6.0
THICKNESS 0.78-2.0

Part No.	Package
THD-3	500

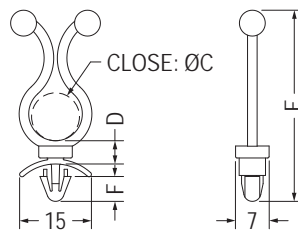
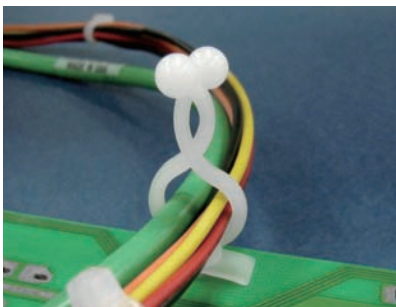

MOUNTING HOLE Ø4.8-Ø5.0
THICKNESS 0.8-2.0

Part No.	C	D	E	F	Package
THD-1	9.8	4.9	40.2	5.2	500
THD-2	17.1	4.9	49.4	5.2	
THD-4	17.5	4.85	47.6	3.6	

扭式固定座 TWIST LOCK

用途：可快速細紮及解開電線，安裝容易。

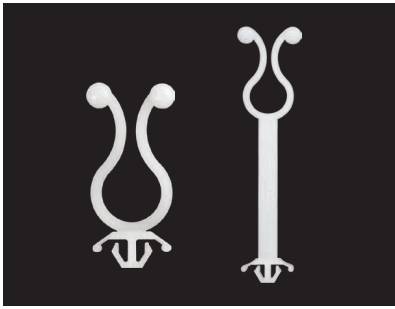

- Material: Nylon 66 (UL)
- Flame Class: 94V-2/94V-0
- Color: Natural/Black
- Unit: mm

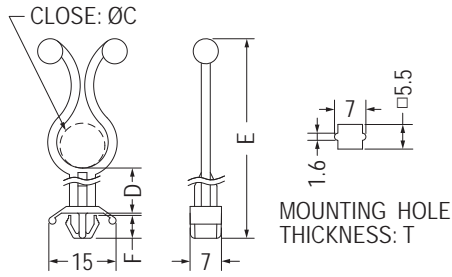

Part No.	C	D	E	F	T	Package
THG-13	10.0	47.0	81.45	5.1	0.8~1.6	500
THG-14	18.0	6.0	52.2	5.9	1.0~2.0	

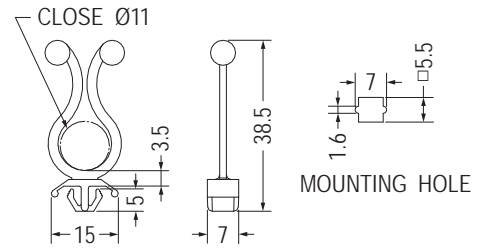

Part No.	Package
THG-12	500

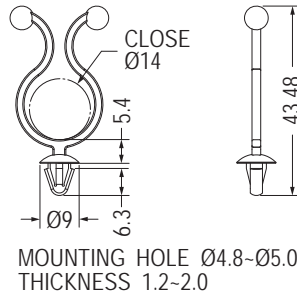
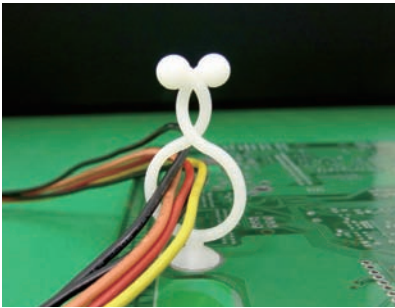

Part No.	Package
THCA-1	500

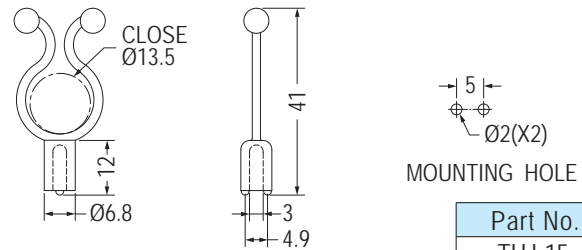
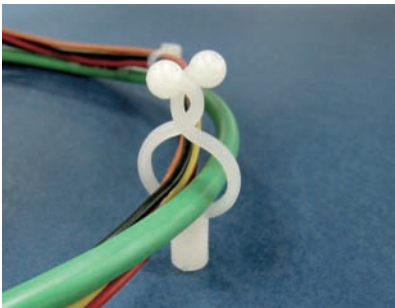

Part No.	Package
THJ-15	500

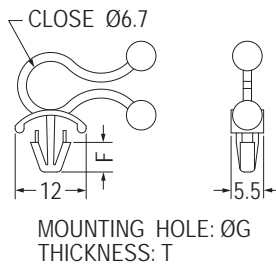
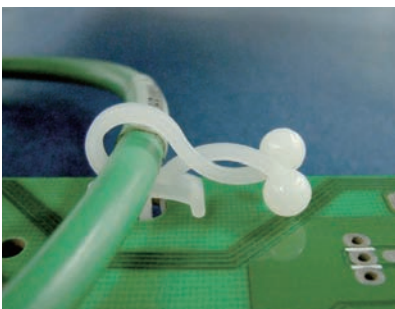

Part No.	F	G	T	Package
THH-8	5.0	4.0	1.6~4.0	500
THH-9	3.5	3.0	0.8~2.0	

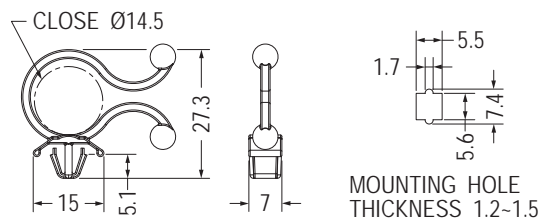
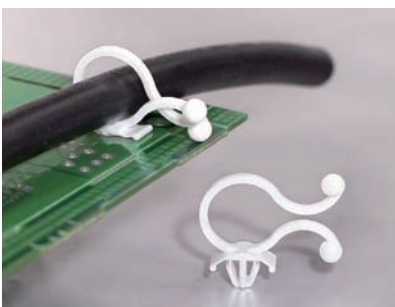

Part No.	Package
THH-13	500



隔離束線座 STANDOFF CABLE CLIP

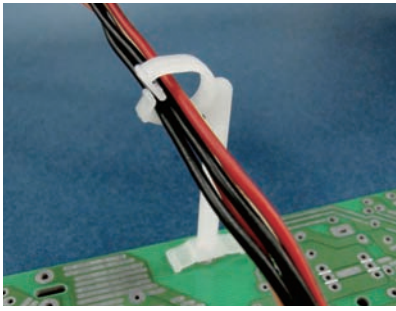

- Material: Nylon 66 (UL)
- Flame Class: 94V-2/94V-0
- Color: Natural/Black
- Unit: mm

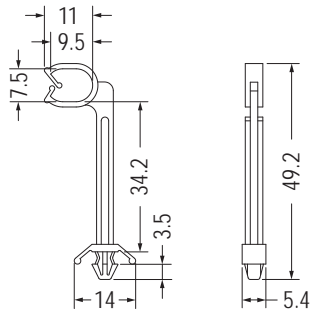

MOUNTING HOLE $\varnothing 4.8$ - $\varnothing 5.0$
THICKNESS 0.5-2.1

Part No.	Package
THEL-41	500

用途：固定電線於PC板或機板上，維修方便，不佔空間。

扭式固定座 TWIST LOCK

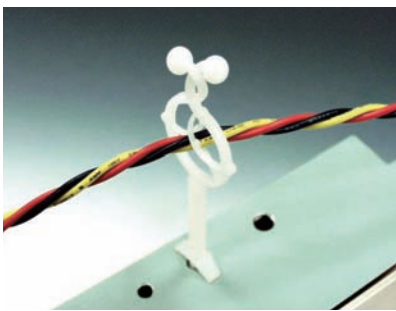

- Material: Nylon 66 (UL)
- Flame Class: 94V-2/94V-0
- Color: Natural/Black
- Unit: mm

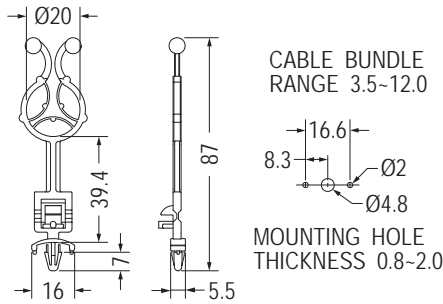

用途：固定電線於PC板或機板上，維修方便，不佔空間。

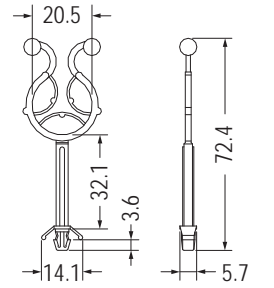

MOUNTING HOLE $\varnothing 4.8$ - $\varnothing 5.0$
THICKNESS 0.5-2.3



Part No.	Package
THFA-1	500

Part No.	Package
THF-1	500

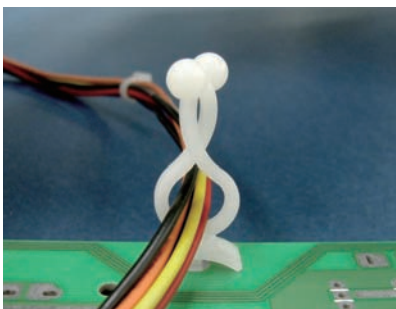

- Material: Nylon 66 (UL)
- Flame Class: 94V-2/94V-0
- Color: Natural/Black
- Unit: mm

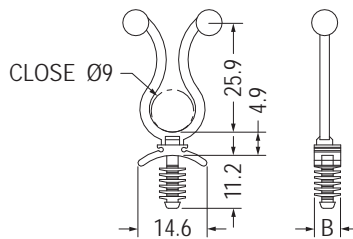

MOUNTING HOLE: $\varnothing G$

用途：可快速捆紮及解開電線，裝配容易，可用於木板上。

Part No.	B	G	Package
WKL-10	5.5	5.0	500
WKL-10A	5.0	4.5	

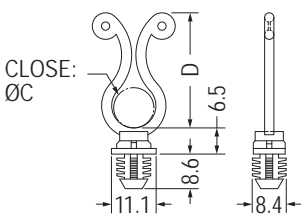

MOUNTING HOLE $\varnothing 7.9$
PANEL THICKNESS 6.4

Part No.	C	D	Package
WTL-11	10.0	28.6	500
WTL-19	18.0	37.5	

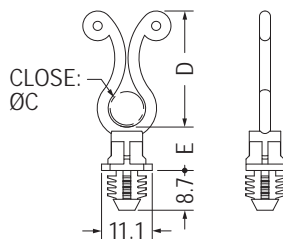

MOUNTING HOLE $\varnothing 7.9$
PANEL THICKNESS 6.4

Part No.	C	D	E	Package
WTL-764	7.6~10.2	25.4	6.4	500
WTL-795	7.6~10.2	25.4	9.5	
WTL-7127	7.6~10.2	25.4	12.7	
WTL-7159	7.6~10.2	25.4	15.9	
WTL-1064	10.2~12.7	28.6	6.4	
WTL-1095	10.2~12.7	28.6	9.5	
WTL-10127	10.2~12.7	28.6	12.7	
WTL-10159	10.2~12.7	28.6	15.9	
WTL-1764	17.8~20.3	38.1	6.4	
WTL-1795	17.8~20.3	38.1	9.5	
WTL-17127	17.8~20.3	38.1	12.7	
WTL-17159	17.8~20.3	38.1	15.9	

扭式固定座 TWIST LOCK

用途：背膠式，可快速拆卸，固定電線，維修方便，整齊美觀。

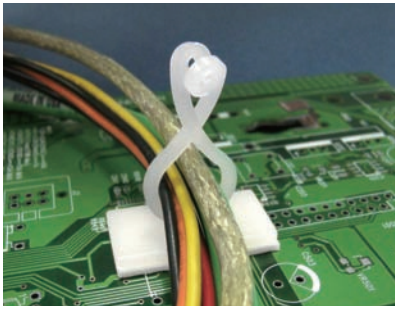

- Material: Nylon 66 (UL)
- Flame Class: 94V-2/94V-0
- Color: Natural/Black
- Unit: mm

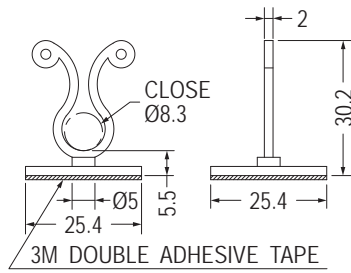

Part No.	Package
KLS-1	250

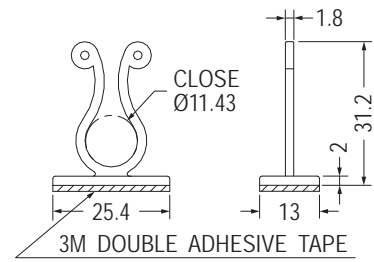

Part No.	Package
KLF-11	500

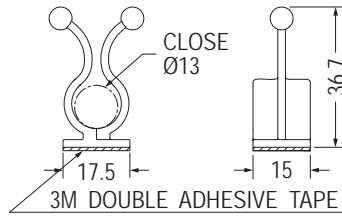

Part No.	Package
KL-26	250

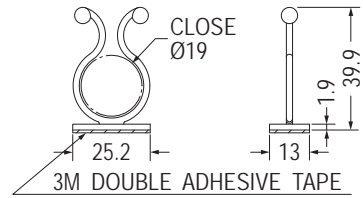

Part No.	Package
KLR-1	500

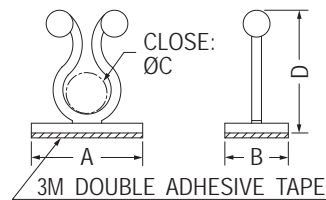

Part No.	A	B	C	D	Package	UL
KL-1	20.0	20.0	13.8	31.9	250	UL
KL-2	20.0	14.0	8.5	26.2	500	UL
KL-2L	25.0	13.0	8.2	27.9		UL
KL-3	21.0	19.0	10.0	28.2		UL
KL-4	18.5	21.0	10.0	27.3		/
KL-5	38.0	20.0	34.0	56.2	100	UL
KL-6	10.0	19.8	5.8	27.6	500	/
KL-7	20.0	13.0	7.2	21.9		UL
KL-11	21.0	19.0	10.0	30.0		/
KL-14	22.1	13.0	12.5	34.8	250	/
KL-16	25.0	13.0	17.0	37.0		UL
KL-19	25.0	13.0	20.0	39.0		UL
KL-22	28.0	15.0	23.0	41.0		UL
KL-23	25.0	20.0	13.2	34.7		/
KL-25	24.9	17.9	18.0	38.0		/

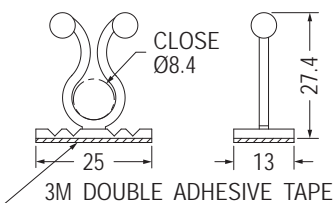

Part No.	Package
KLB-1	500

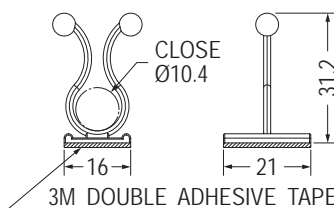

Part No.	Package
KLC-1	250

扭式固定環 TWIST LOCK

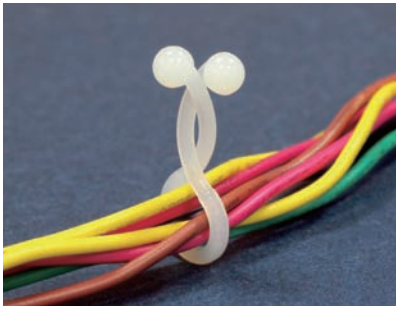

- Material: Nylon 66 (UL)
- Flame Class: 94V-2/94V-0
- Color: Natural/Black
- Unit: mm

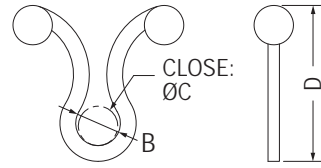
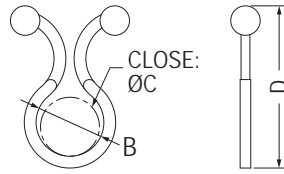

【 TL-34, TL-36, TL-37 】

UL
E217732
UL 1565

用途：用於配線中，有快速捆紮及解開之優點，可重複使用。

Part No.	B	C	D	Package	UL
TL-1	5.1	4.0	17.8	1000	UL
TL-2	8.3	7.3	23.8		UL
TL-3A	11.5	10.0	27.5		UL
TL-4	15.4	13.8	30.4		UL
TL-5	18.8	17.2	35.0		UL
TL-6	25.8	24.2	41.4	500	UL
TL-7	22.0	19.5	42.0		UL
TL-8	5.6	5.0	16.5		
TL-9	11.0	9.7	30.0		
TL-10	19.2	16.3	38.5		
TL-11	5.2	4.2	22.0		
TL-12	8.6	8.0	26.0		

Part No.	B	C	D	Package	UL
TL-13	13.2	11.5	32.5	500	
TL-14	15.0	14.5	35.1		
TL-27	27.5	27.0	46.0		
TL-28	29.0	26.8	55.5		
TL-29	18.0	17.0	40.0		
TL-30	19.2	16.5	38.5		
TL-31	18.6	17.0	40.0		
TL-32	14.8	13.5	35.0		
TL-34	5.1	4.0	17.8		
TL-35	34.0	32.0	56.0		
TL-36	22.0	20.0	42.0		
TL-37	24.9	23.0	44.3		
TL-38	40.0	38.0	63.0		

扭式固定座 TWIST LOCK



- Material: Nylon 66 (UL)
- Flame Class: 94V-2/94V-0
- Color: Natural/Black
- Unit: mm

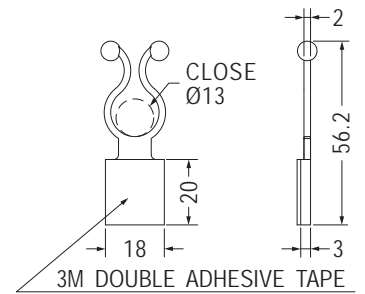
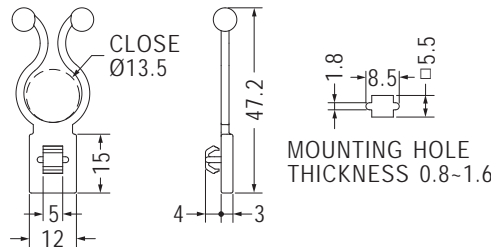

Part No.	Package
THJA-1	500

Part No.	Package
THM-1	1000

用途：可快速捆紮及解開電線，安裝容易。

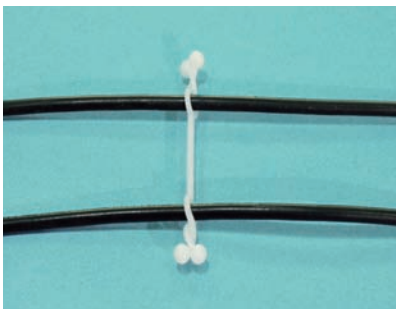

- Material: Nylon 66 (UL)
- Flame Class: 94V-2/94V-0
- Color: Natural/Black
- Unit: mm

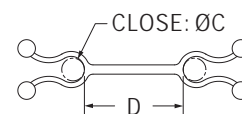
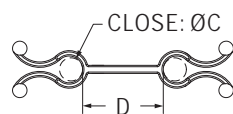
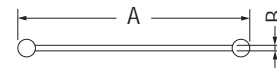
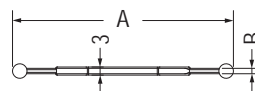

【 2L-10 】

UL
E217732
UL 1565

用途：用於電子內部電線固定，安裝容易，美觀不脫落。

Part No.	A	B	C	D	Package	UL
2L-7	75.0	1.8	6.3	33.2	500	UL
2L-8	56.0	1.6	8.5	13.2		UL
2L-10	82.2	2.0	8.6	30.0		

防落下固定帶 ANTI-EARTHQUAKE FASTENER

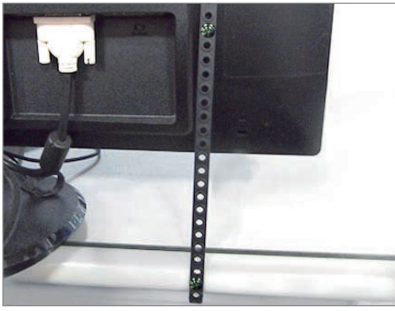

- Material: Nylon 66 (UL)
- Flame Class: 94V-2/94V-0
- Color: Natural/Black
- Unit: mm

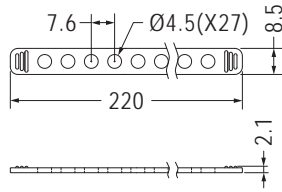

Part No.	Package
CCHD-220	500

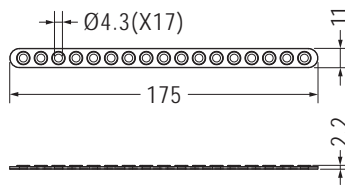

Part No.	Package
CCHD-175	500

用途：預防LCD-TV於地震時落下，固定物件用。

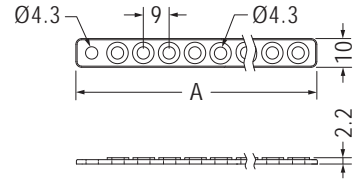

Part No.	A	Poles	Package
CCHD-172	172.75	19.0	500
CCHD-210	210.0	22.0	

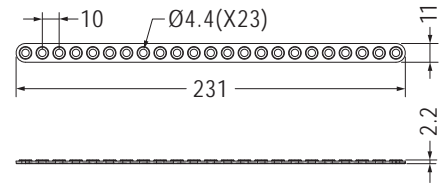

- Material: PP
- Color: Black

Part No.	Package
CCHD-231	500

束線帶固定座 CABLE TIE MOUNT

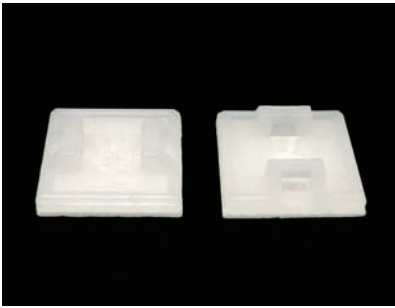

- Material: Nylon 66 (UL)
- Flame Class: 94V-2/94V-0
- Color: Natural/Black
- Unit: mm

用途：配合束線帶使用，固定電線，背膠式亦可配合螺絲，使機器內部走線美麗、整齊。

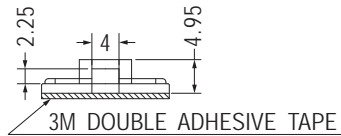
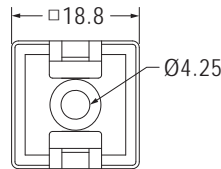

Part No.	Package
CM-18	1000

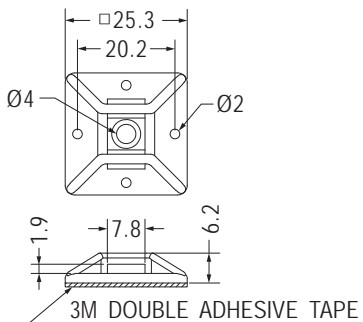

Part No.	Package
CM-1	500

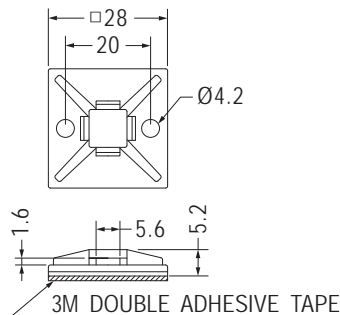

Part No.	Package
CM-28S	250

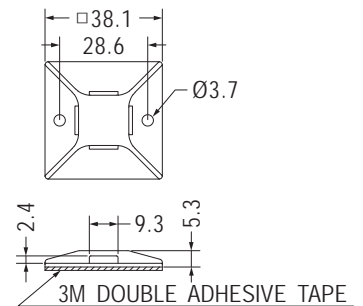

Part No.	Package
CM-38	250

束線帶固定座 CABLE TIE MOUNT

用途：配合束線帶使用，固定電線，背膠式亦可配合螺絲，使機器內部走線美麗、整齊。

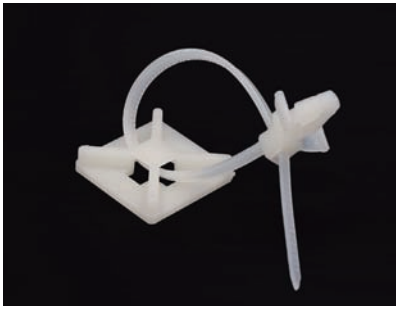

- Material: Nylon 66 (UL)
- Flame Class: 94V-2/94V-0
- Color: Natural/Black
- Unit: mm

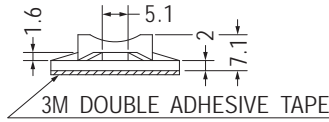
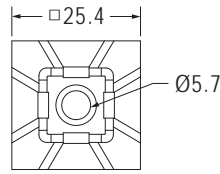

Part No.	Package
CM-25	500

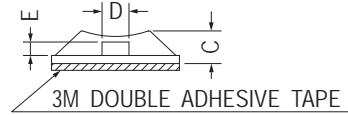
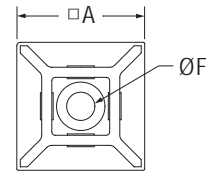
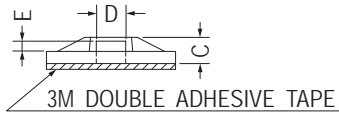
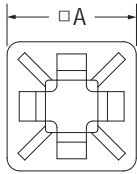

Part No.	A	C	D	E	Package	UL
CM-13	13.0	3.2	3.2	1.3	1000	UL
CM-16	16.0	4.0	3.8	1.5		UL
CM-19	19.1	4.0	4.0	1.6	500	UL
CM-19L	19.5	4.8	5.0	1.7		UL
CM-20	20.0	4.3	4.8	1.6		UL

Part No.	A	C	D	E	F	Package
CM-19S	19.0	5.0	4.0	1.9	3.0	500
CM-19SL	19.0	5.0	4.0	2.0	4.2	
CM-28	27.8	5.5	6.0	2.0	5.0	250

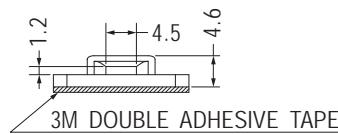
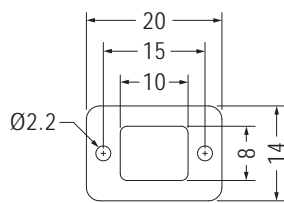

Part No.	Package
CM-29	1000

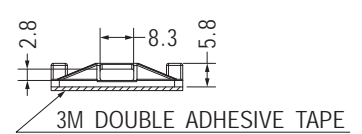
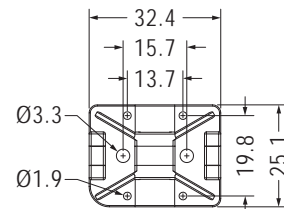

Part No.	Package
CM-30	250

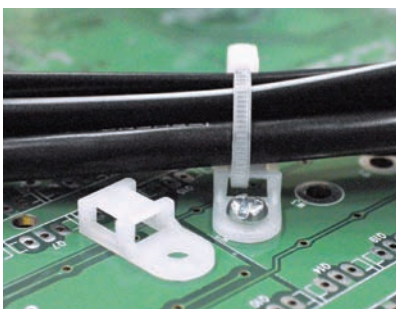

- Material: Nylon 66 (UL)
- Flame Class: 94V-2/94V-0
- Color: Natural/Black
- Unit: mm

用途：用螺絲固定於機板上，配合束線帶固定電線。

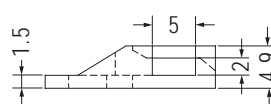
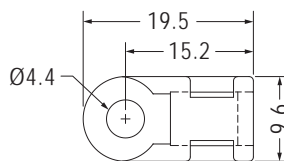

Part No.	Package
TH-1	1000

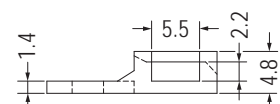
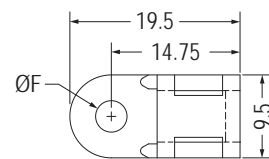

Part No.	F	Package
TH-3	3.6	1000
TH-3L	4.7	

束線帶固定座 CABLE TIE MOUNT

用途：用螺絲固定於機板上，配合束線帶固定電線。

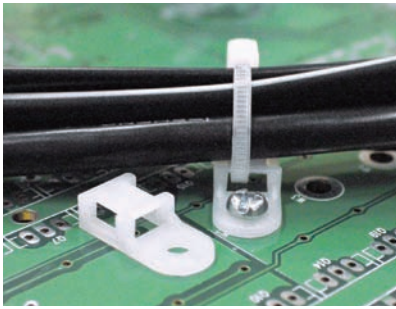

- Material: Nylon 66 (UL)
- Flame Class: 94V-2/94V-0
- Color: Natural/Black
- Unit: mm

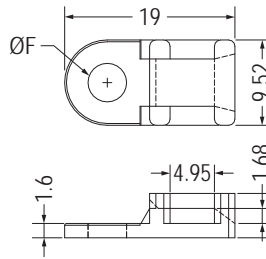

Part No.	F	Package
TH-4	4.3	1000
TH-7	6.5	

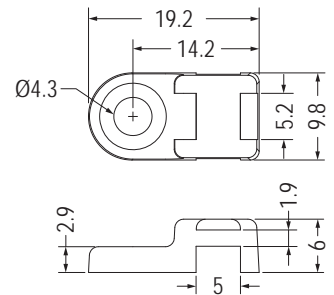

Part No.	Package
TH-5	1000

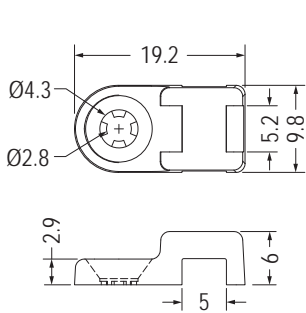

Part No.	Package
TH-5-1	1000

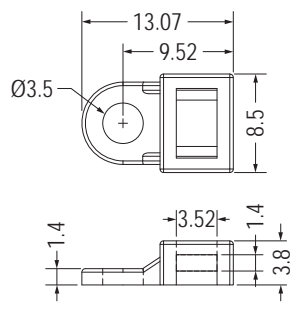

Part No.	Package
TH-6	1000

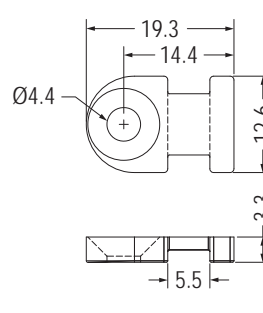

Part No.	Package
TH-8	1000

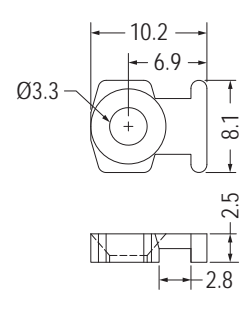

Part No.	Package
TH-9	1000

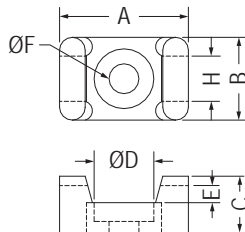

Part No.	A	B	C	D	E	F	H	Package
TH-2	15.2	9.7	6.6	6.9	2.0	3.5	5.2	1000
TH-2S	13.3	8.2	5.85	5.9	1.75	3.2	3.6	

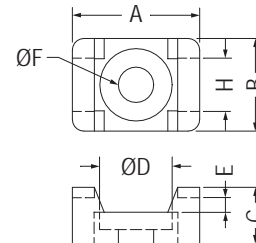

Part No.	A	B	C	D	E	F	H	Package
TM-2S6	14.9	9.6	7.2	7.8	1.5	3.7	5.6	1000
TM-2S8	14.9	9.6	7.2	7.8	1.5	4.5	5.6	
TM-3S8	22.0	16.0	9.6	8.0	2.3	4.5	9.2	500
TM-3S10	22.0	16.0	9.6	9.6	2.3	4.8	9.2	
TM-3S25	22.0	16.0	9.6	12.7	2.3	6.4	9.2	

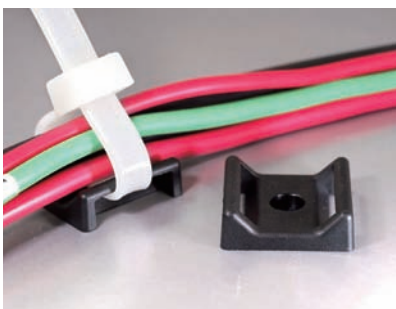

- Material: Nylon 66 (UL)+GF
- Flame Class: 94HB/94V-0
- Color: Natural/Black
- Unit: mm

用途：用螺絲固定於機板上，配合束線帶固定電線。

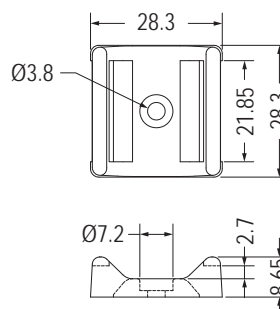

Part No.	Package
TM-4	500



束線帶固定座 CABLE TIE MOUNT

用途：用螺絲固定於機板上，配合束線帶固定電線。



- Material: Nylon 66 (UL)
- Flame Class: 94V-2/94V-0
- Color: Natural/Black
- Unit: mm

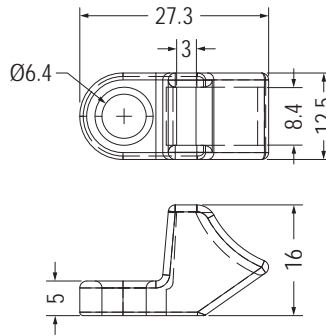

Part No.	Package
THMA-1	1000



- Material: Nylon 66 (UL)
- Flame Class: 94V-2/94V-0
- Color: Natural/Black
- Unit: mm

用途：使用背膠固定於機板上，配合束線帶固定電線。

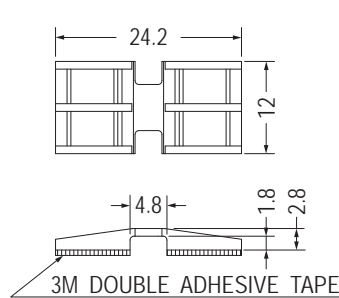

Part No.	Package
THU-1	1000

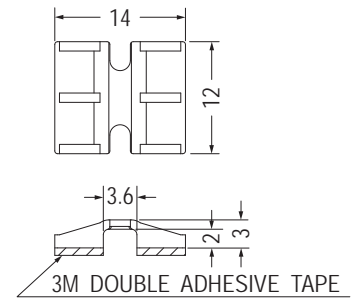

Part No.	Package
THU-2	1000



- Material: Nylon 66 (UL)
- Flame Class: 94V-2/94V-0
- Color: Natural/Black
- Unit: mm

用途：配合束線帶固定電線於機殼上，方便安裝，強韌牢固。

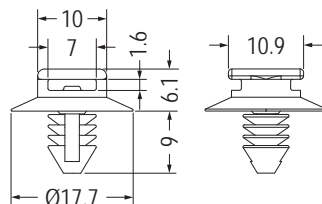

MOUNTING HOLE Ø6.0-Ø6.4
THICKNESS 0.8-9.0

Part No.	Package
CCMF-2	1000

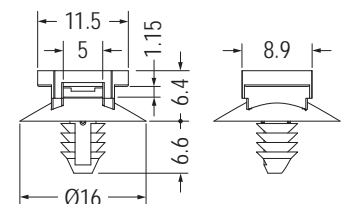

MOUNTING HOLE Ø4.5-Ø5.0
THICKNESS 0.8-7.0

Part No.	Package
CCMF-3	1000

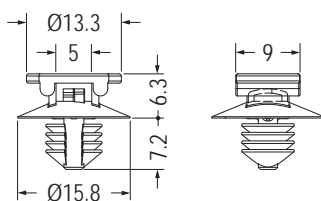

MOUNTING HOLE Ø6.5-Ø7.0
THICKNESS 0.8-3.0

Part No.	Package
CCMF-5	1000

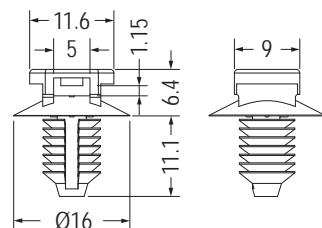

MOUNTING HOLE Ø6.4-Ø7.1
THICKNESS 0.8-6.0

Part No.	Package
CCMF-7	1000

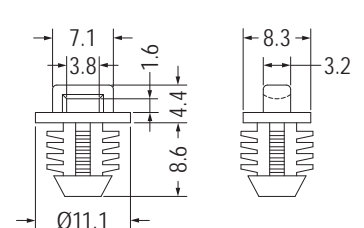

MOUNTING HOLE Ø7.9
THICKNESS 6.4

Part No.	Package
CCMF-1	1000

束線帶固定座 CABLE TIE MOUNT

用途：配合束線帶固定電線於機殼上，方便安裝，強韌牢固。

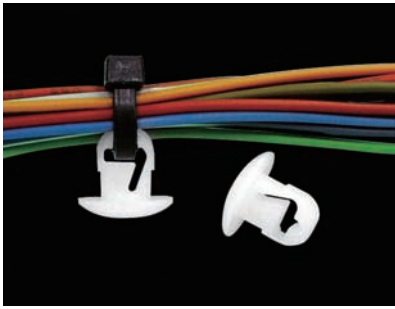

- Material: Nylon 66 (UL)
- Flame Class: 94V-2/94V-0
- Color: Natural/Black
- Unit: mm

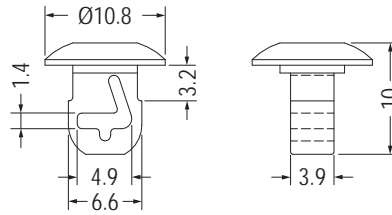

MOUNTING HOLE Ø6.4

Part No.	Package
CCM-1	1000

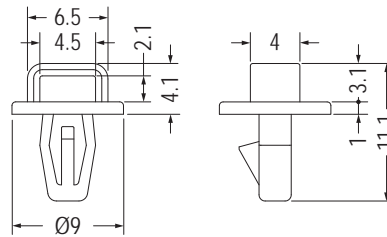

MOUNTING HOLE Ø4.0
THICKNESS 1.6-2.0

Part No.	Package
CCMT-2	1000

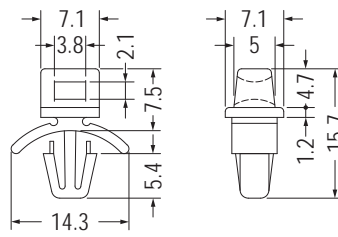
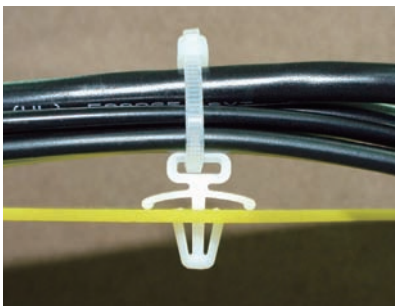

MOUNTING HOLE Ø4.8
THICKNESS 0.8-2.0

• Patented (專利品)

Part No.	Package
CCME-1	1000

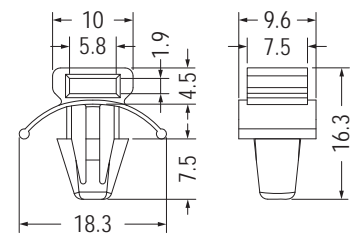

MOUNTING HOLE Ø6.2-Ø6.3
THICKNESS 0.8-3.6

Part No.	Package
CCMW-3	1000

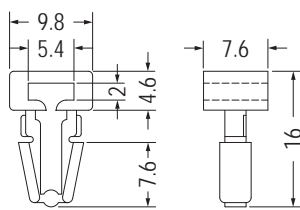

MOUNTING HOLE Ø6.4
THICKNESS 3.17

Part No.	Package
CCMV-1	1000

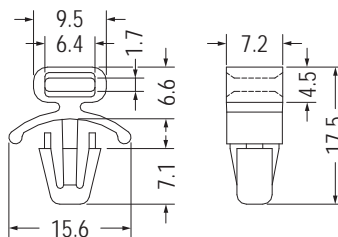

MOUNTING HOLE Ø6.4
THICKNESS 1.2-2.8

Part No.	Package
CCMW-1	1000

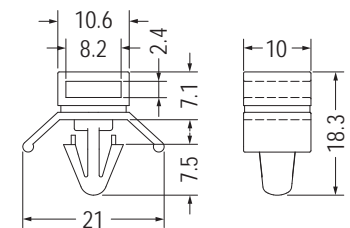

MOUNTING HOLE Ø6.2
THICKNESS 0.8-3.2

Part No.	Package
CCMW-2	1000

電線固定座 WIRE SADDLE



- Material: Nylon 66 (UL)
- Flame Class: 94V-2/94V-0
- Color: Natural/Black
- Unit: mm

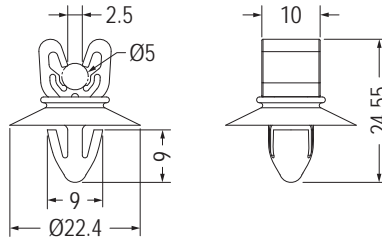

MOUNTING HOLE Ø8.0
THICKNESS 1.2

Part No.	Package
CHUK-1	500

用途：固定電源於PC板或機板上，維修方便，不佔空間。

插頭固定扣 SOCKET MOUNT

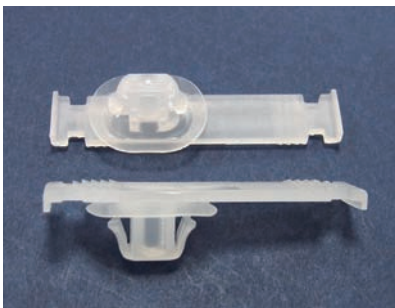

- Material: PP (UL)
- Flame Class: 94HB
- Color: Natural/Black
- Unit: mm

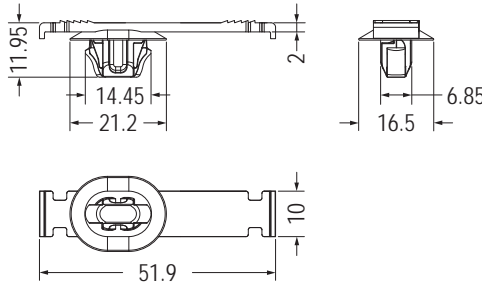

RECOMMENDED MOUNTING HOLE
RECOMMENDED THICKNESS 2.0

Part No.	Package
YJECL-1	500

用途：配合束線帶固定電線於機殼上，方便安裝，強韌牢固。

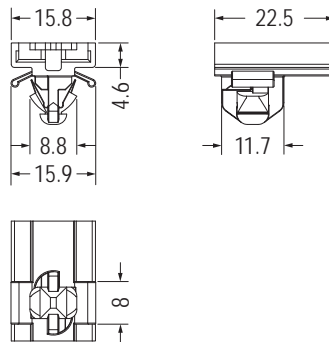

RECOMMENDED MOUNTING HOLE
RECOMMENDED THICKNESS 2.0

Part No.	Package
YJECL-2	500

電線固定扣 CABLE CLAMP



- Material: PC (UL)
- Flame Class: 94V-2
- Color: Natural/Transparent
- Unit: mm

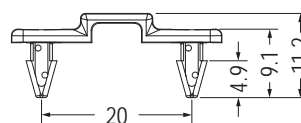

MOUNTING HOLE Ø3.0
THICKNESS 2.4

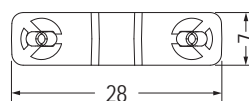

Part No.	Package
LPZ-5	1000

用途：用於電線之固定。

電線固定扣 WIRE BUTTON



- Material: Nylon 6 (UL)
- Flame Class: 94V-2/94V-0
- Color: Natural/Black
- Unit: mm

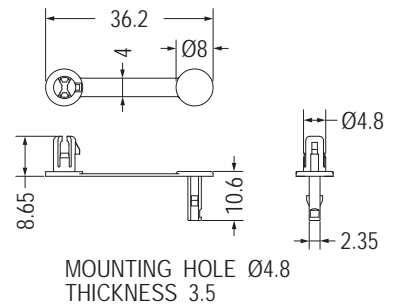
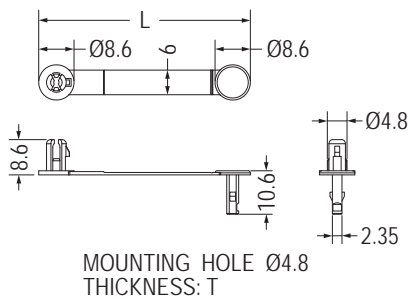

Part No.	L	T	Package
CCU-2	51.6	0.8~3.2	500
CCU-3	71.6	0.6~3.0	
CCU-4	99.0	0.6~3.0	

- Material: Nylon 66 (UL)

Part No.	Package
CCU-1	500

接地線夾 GROUNDING CABLE CLAMP



- Material: SPTE
- Unit: mm

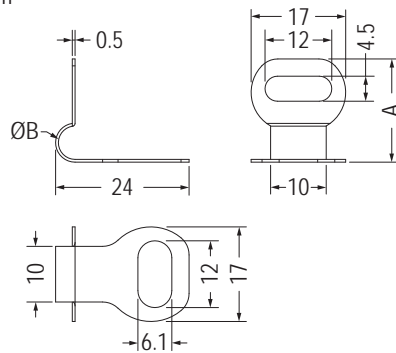

用途：用於夾持隔離電線再用螺絲固定，接地效果佳，防干擾。

Part No.	A	B	Package
KMCC-1	18.55	6.0	500
KMCC-2	19.6	8.0	

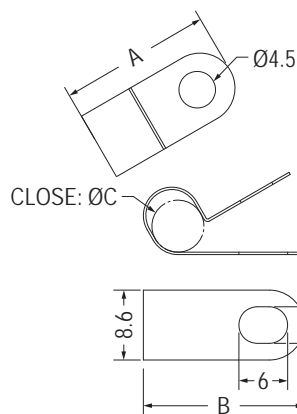
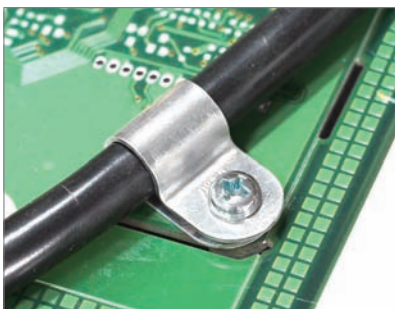

- Material: SUS

Part No.	A	B	C	Package
KTCC-3	17.2	17.6	3.0	1000
KTCC-4	17.2	17.6	4.0	
KTCC-5	17.9	18.7	4.8	
KTCC-6	18.7	19.8	6.4	
KTCC-9	18.65	20.62	9.0	

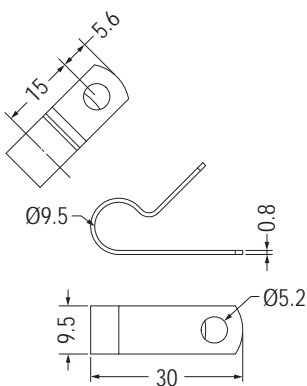

- Material: Aluminum

Part No.	Package
KTCC-22	1000

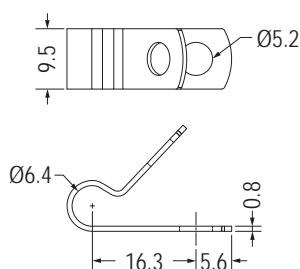

- Material: Aluminum

Part No.	Package
KTCC-23	1000

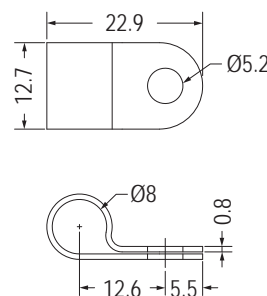

- Material: Aluminum

Part No.	Package
KTCC-12	1000

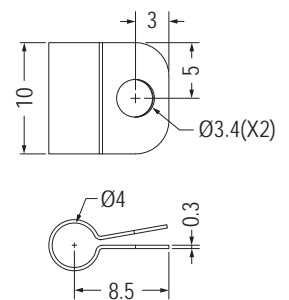

- Material: Steel
- Finish: Zinc Plated

Part No.	Package
KTCC-16	1000

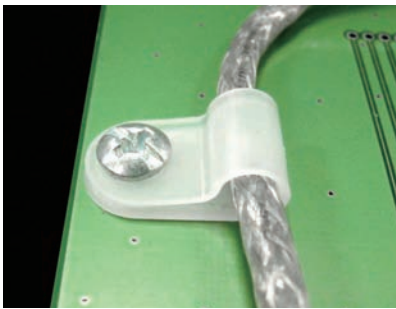

- Material: Nylon 66 (UL)
- Flame Class: 94V-2/94V-0
- Color: Natural/Black
- Unit: mm

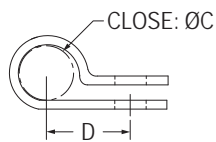
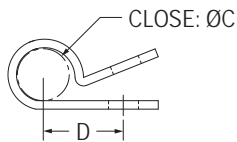
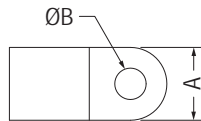
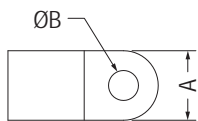

【 CC-10, CC-35, CC-50 】

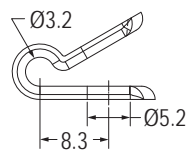
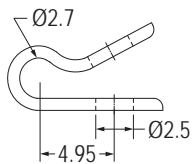
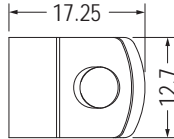
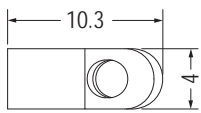

Part No.	Package
CC-28	1000

Part No.	Package
CC-55	1000

Part No.	A	B	C		D	Package
			mm	inch		
CC-1SS	6.5	3.8	3.2	1/8	6.8	1000
CC-1S	9.2	5.4	3.2	1/8	8.2	
CC-1	13.2	5.4	3.0	1/8	8.9	
CC-2	10.0	5.4	4.5	3/16	10.2	
CC-3	9.3	5.0	6.2	1/4	10.2	
CC-4	9.5	5.0	7.6	5/16	10.5	
CC-4L	9.2	5.4	8.0	5/16	10.7	
CC-5	9.5	4.8	9.0	3/8	12.4	
CC-5L	12.3	5.4	9.0	3/8	13.2	
CC-6	12.7	4.8	11.5	1/2	14.7	
CC-7	12.9	5.4	12.8	1/2	16.0	
CC-7S	12.5	4.8	15.5	5/8	16.7	200
CC-8	12.9	5.4	17.0	3/4	19.6	
CC-9	12.9	5.4	20.0	7/8	21.2	250
CC-10	12.9	5.4	24-27	1-1/8	23.5	200
CC-12	9.9	4.4	3.0	1/8	8.5	1000
CC-13	9.5	3.2	8.3	5/16	12.0	
CC-14	6.3	3.7	3.5	1/7	6.4	
CC-15	9.6	4.4	5.6	1/4	12.1	
CC-16	11.6	6.4	5.6	1/4	12.1	
CC-17	10.0	4.2	5.0	1/4	9.5	
CC-18	10.0	4.2	11.0	7/16	13.0	
CC-19	9.9	4.4	4.5	3/16	7.75	
CC-20	10.0	4.3	6.0	1/4	9.9	
CC-31	10.0	4.2	11.5	1/2	14.0	
CC-32	10.0	4.2	5.0	1/4	9.5	
CC-35	6.5	3.3	3.0	1/8	9.5	
CC-37	10.9	5.0	7.5	5/16	10.5	
CC-38	12.9	6.6	7.5	5/16	10.5	
CC-44	10.0	3.5	4.5	3/16	10.2	
CC-50	4.0	2.5	3.1	1/8	6.0	
CC-51	12.7	5.2	9.5	3/8	12.3	
CC-59	12.7	5.2	31.75	1-1/4	26.9	250

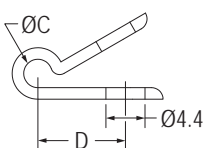
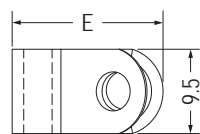

Part No.	C	D	E	Package
CC-25	3.2	9.86	17.0	500
CC-26	4.8	11.10	19.0	

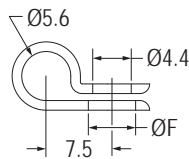
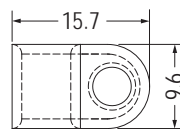

Part No.	F	Package
CC-24	5.4	500
CC-45	4.4	

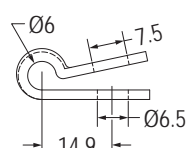
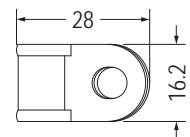

Part No.	Package
CC-21	500

電線固定扣 CABLE CLAMP

用途：配合螺絲，固定電線，整齊美觀。

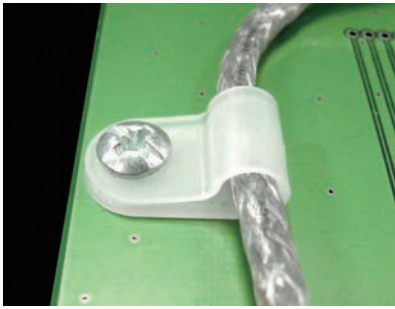

- Material: Nylon 66 (UL)
- Flame Class: 94V-2/94V-0
- Color: Natural/Black
- Unit: mm

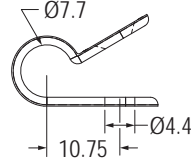
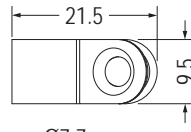

Part No.	Package
CC-53	1000

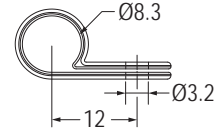
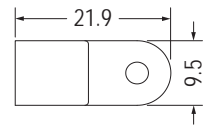

Part No.	Package
CC-29	1000

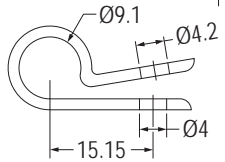
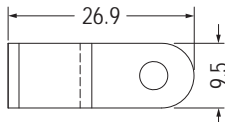

Part No.	Package
CC-42	1000

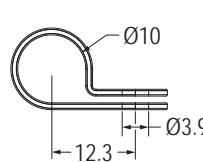
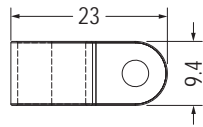

Part No.	Package
CC-54	1000

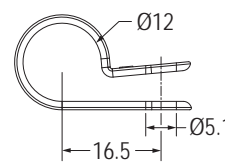
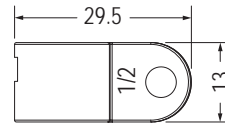

Part No.	Package
CC-56	1000

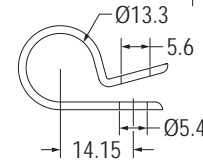
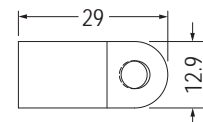

Part No.	Package
CC-23	500

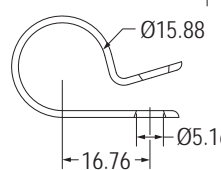
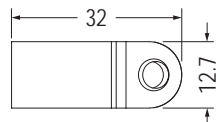

Part No.	Package
CC-57	1000

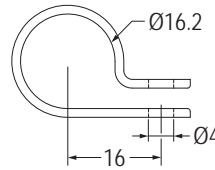
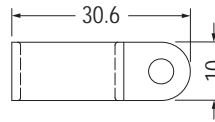

Part No.	Package
CC-46	1000

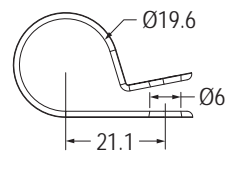
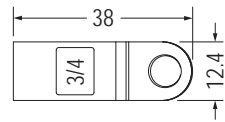

Part No.	Package
CC-49	500

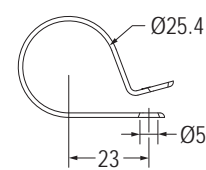
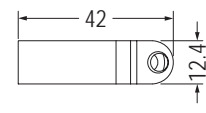

Part No.	Package
CC-58	1000

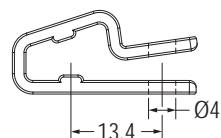
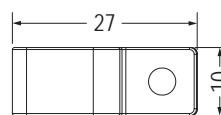

Part No.	Package
CCP-2	1000

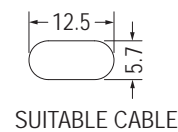

SUITABLE CABLE

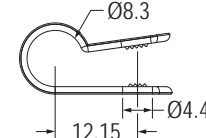
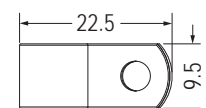

Part No.	Package
CCF-1	1000

電線固定扣 CABLE CLAMP

用途：配合螺絲，固定電線，整齊美觀。

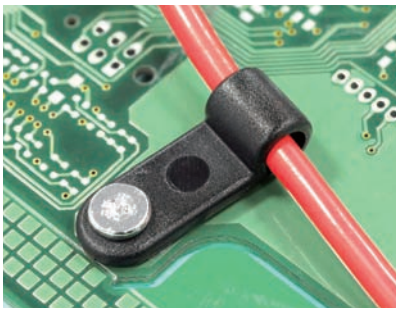

- Material: Nylon 66 (UL)
- Flame Class: 94V-2/94V-0
- Color: Natural/Black
- Unit: mm

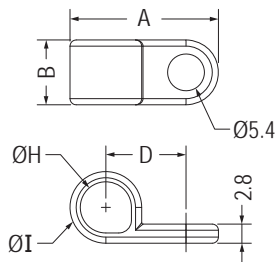

Part No.	A	B	D	H	I	Package
CCO-4	21.75	9.5	11.75	7.5	10.5	500
CCO-5	28.2	10.0	19.0	5.4	8.4	

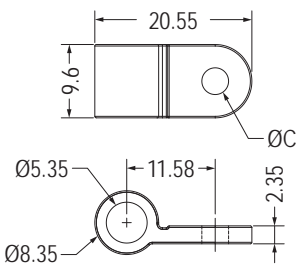

Part No.	C	Package
CCO-1	3.5	500
CCO-2	4.7	

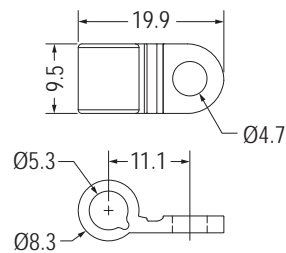

Part No.	Package
CCO-6	500

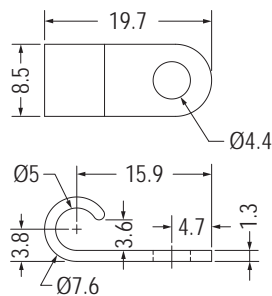
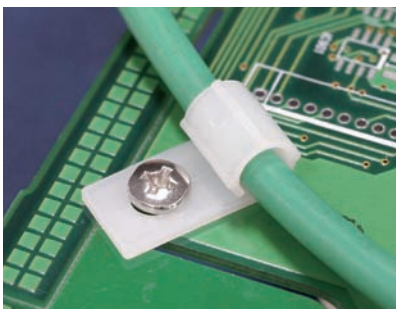

Part No.	Package
CD-5	500

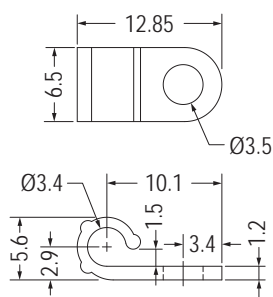

Part No.	Package
CD-3.4	500

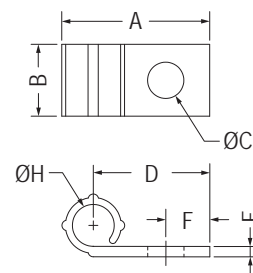

Part No.	A	B	C	D	E	F	H	Package
CD-6	21.2	10.3	5.2	16.7	1.5	6.3	6.0	500
CD-6S	21.2	10.3	3.2	16.7	1.5	6.3	6.0	
CD-9.2	20.6	10.2	5.2	14.0	1.3	4.4	9.2	
CD-9.2S	20.0	10.2	3.2	13.45	1.3	4.5	9.2	

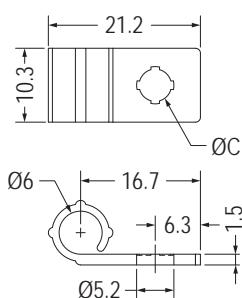

Part No.	C	Package
CDKW-6	4.5	1000
CDKW-6-3	3.0	

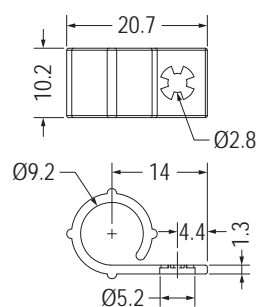

Part No.	Package
CDKW-9.2	1000

電線固定扣 CABLE CLAMP

用途：配合螺絲，固定電線，整齊美觀。

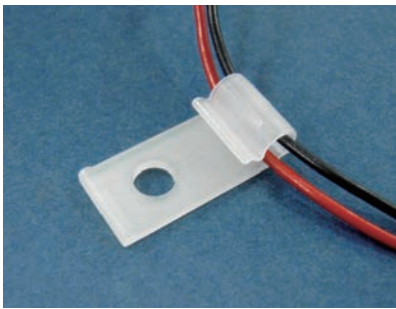

- Material: Nylon 66 (UL)
- Flame Class: 94V-2/94V-0
- Color: Natural/Black
- Unit: mm

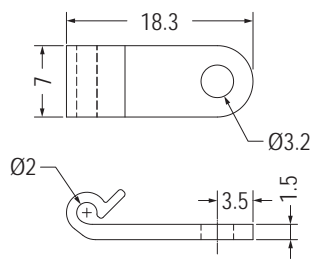

Part No.	Package
CDV-2.3	1000

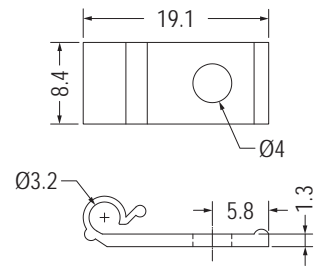

Part No.	Package
CDV-3.2	1000

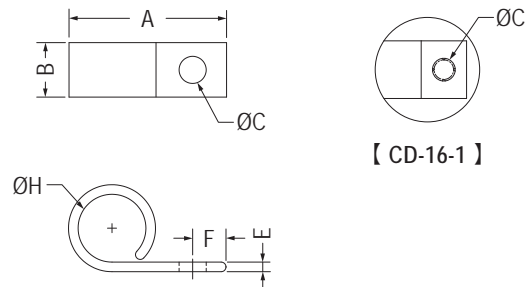
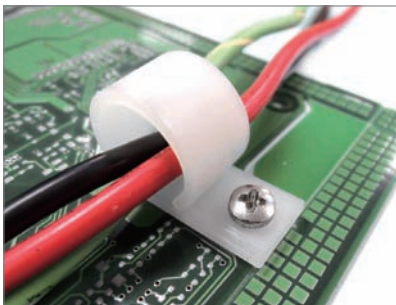

【 CD-16-1 】

Part No.	A	B	C	E	F	H	Package
CD-12.7	29.5	10.2	5.08	1.8	6.35	12.7	500
CD-12.7-3.2	29.5	10.2	3.2	1.8	6.35	12.7	
CD-16	30.0	12.7	5.0	2.0	5.0	16.0	
CD-16-1	30.0	12.7	5.0	2.0	5.0	16.0	
CD-19	32.54	12.7	5.18	2.03	4.82	19.05	
CD-19-6.3	32.54	12.7	6.3	2.03	4.82	19.1	
CD-26	39.85	12.6	5.15	2.2	5.18	26.0	250
CD-40	53.5	12.6	5.0	2.5	4.8	36.9	100

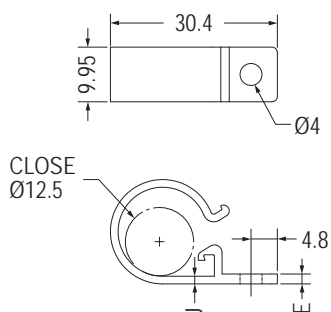

Part No.	E	J	Package
CCA-1	1.8	1.4	500
CCA-2	1.4	1.3	

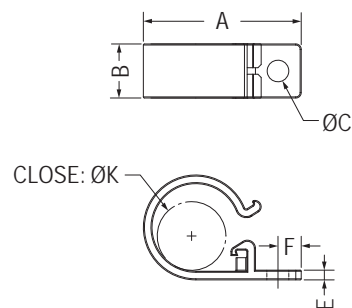

Part No.	A	B	C	E	F	K	Package
CCB-1	29.2	10.0	4.0	1.8	4.3	12.7	500
CCB-1S	29.2	10.0	3.1	1.8	4.3	12.7	
CCB-2	21.0	10.0	4.0	1.2	6.0	5.5	1000
CCB-2S	21.0	10.0	3.1	1.2	6.0	5.5	
CCB-3	39.6	12.7	4.0	2.0	4.2	17.8	200
CCB-4	50.0	12.7	4.0	2.2	4.3	25.0	

電線固定扣 CABLE CLAMP

用途：使用螺絲將電線固定於機器中，固定電線不易鬆動。



- Material: Nylon 66 (UL)
- Flame Class: 94V-2/94V-0
- Color: Natural/Black
- Unit: mm

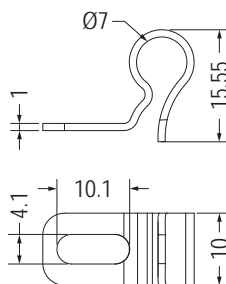

Part No.	Package
CCMG-1	1000

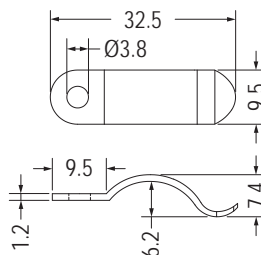
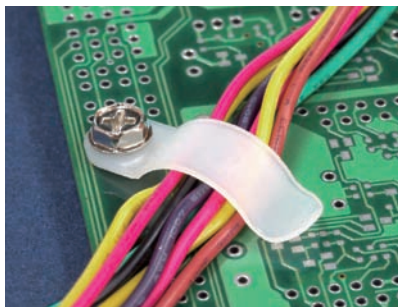

Part No.	Package
CDK-1	1000

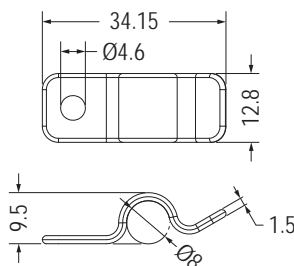

Part No.	Package
CDK-3	1000

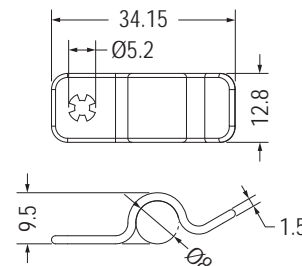

Part No.	Package
CDK-3-1	1000

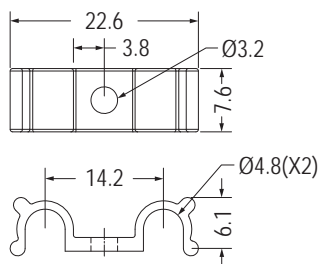

Part No.	Package
CLIA-3	1000

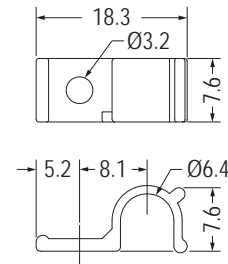

Part No.	Package
CDK-5	1000

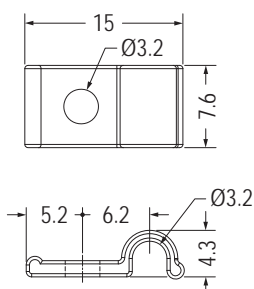

Part No.	Package
CDK-7	1000

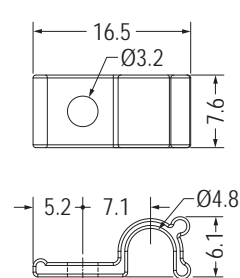

Part No.	Package
CDK-8	1000

電線固定扣 CABLE CLAMP

用途：背膠式，可快速拆卸，固定電線，維修方便，不佔空間。



- Material: Nylon 66 (UL)
- Flame Class: 94V-2/94V-0
- Color: Natural/Black
- Unit: mm

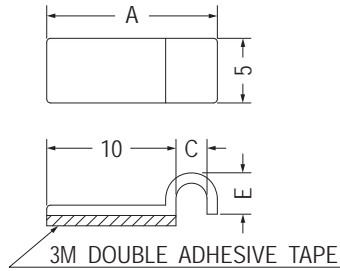

Part No.	A	C	E	Package
CDK-2	13.2	2.4	3.2	1000
CDK-6	12.3	1.5	2.4	



- Material: Nylon 66 (UL)
- Flame Class: 94V-2/94V-0
- Color: Natural/Black
- Unit: mm

用途：使用螺絲將電線固定於機器中，固定電線不易鬆動。

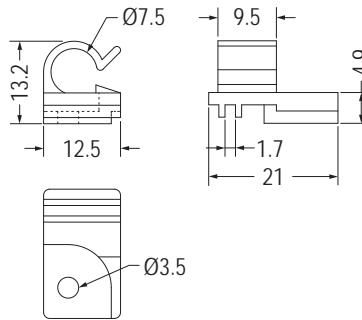

Part No.	Package
WCL-3	500

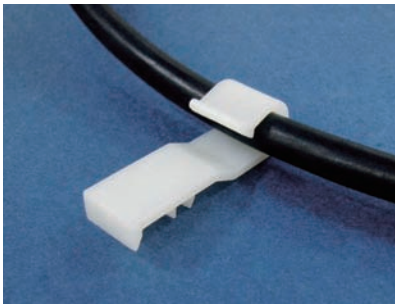

- Material: Nylon 66 (UL)
- Flame Class: 94V-2/94V-0
- Color: Natural/Black
- Unit: mm

用途：固定電線於機器中，整齊美觀。

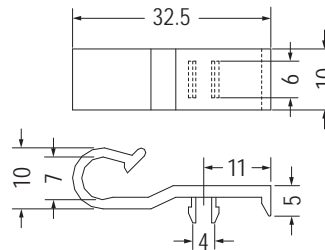

Part No.	Package
WCL-2	500

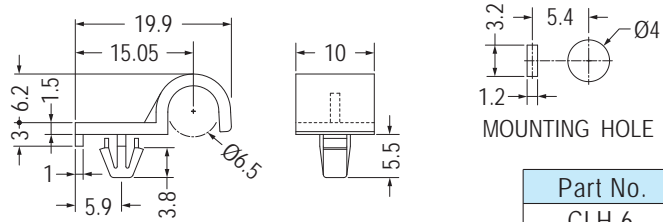
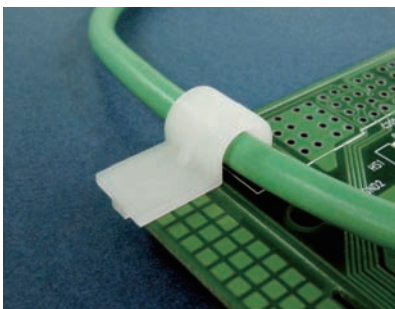

Part No.	Package
CLH-6	500

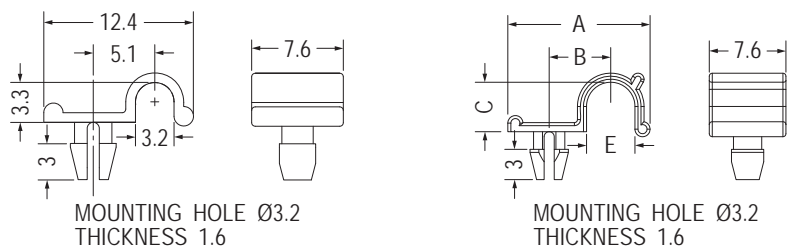

Part No.	Package
CLI-4	500

Part No.	A	B	C	E	Package
CLI-5	14.1	6.1	4.9	4.8	2000
CLI-6	15.8	7.0	6.5	6.1	

電線固定座 CABLE CLAMP



- Material: Nylon 66 (UL)
- Flame Class: 94V-2/94V-0
- Color: Natural/Black
- Unit: mm

用途：適用螺絲M4、長12，可快速拆卸，固定電線，維修方便，不佔空間。

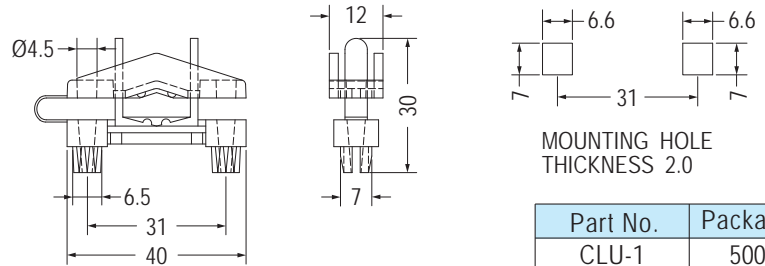

LCD理線座 CABLE CLIP



- Material: HIPS (UL)
- Flame Class: 94HB
- Color: Gray
- Unit: mm

用途：固定LCD-TV背部電線，美觀整齊。

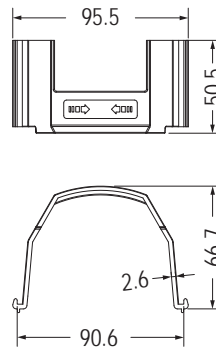

電線固定扣 CABLE CLAMP



- Material: Nylon 66 (UL)
- Flame Class: 94V-2/94V-0
- Color: Natural/Black
- Unit: mm

用途：固定電線於機板上，維修方便，不佔空間。

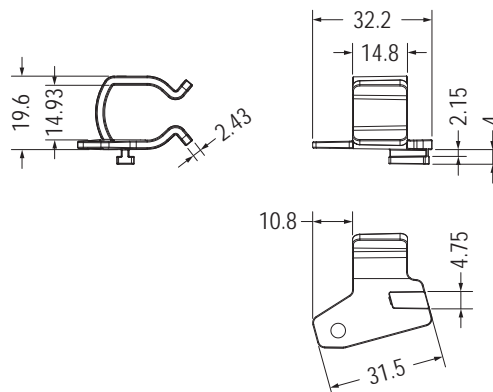

電線固定扣 CABLE CLAMP

用途：固定電線於機器中，整齊美觀。

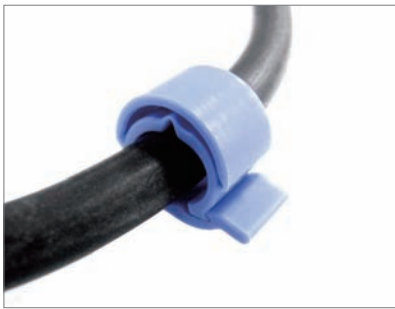

- Material: Nylon 66 (UL)
- Flame Class: 94V-2/94V-0
- Color: Natural/Black
- Unit: mm

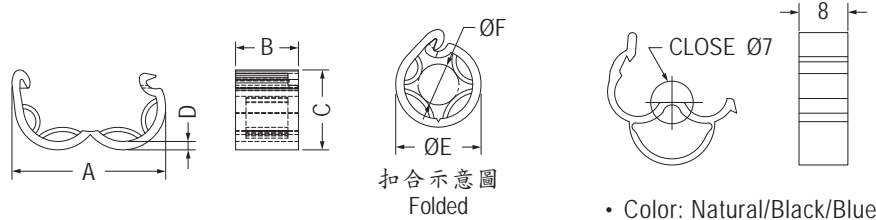

- Color: Natural/Black/Blue

Part No.	A	B	C	D	E	F	Package
WAL-1	14.65	6.0	7.6	0.8	8.15	3.9	1000
WAL-2	18.34	5.3	11.6	1.0	10.20	5.3-5.5	

Part No.	Package
WAK-1	1000



- Material: Nylon 66 (UL)
- Flame Class: 94V-2/94V-0
- Color: Natural/Black
- Unit: mm

用途：固定電線於機器中，防止電線斷路。

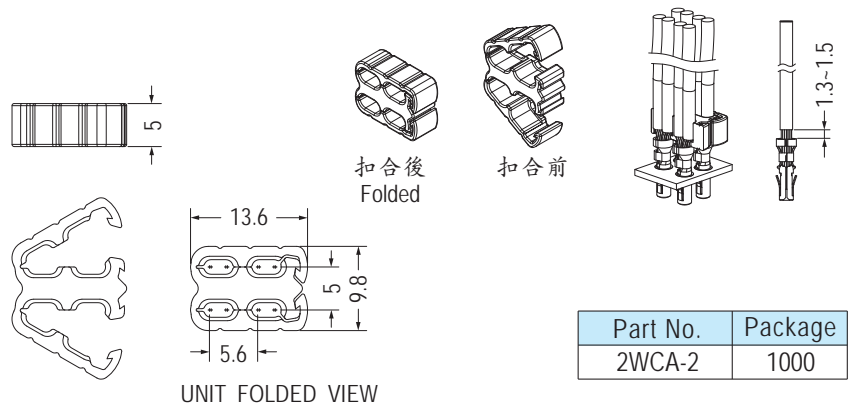

Part No.	Package
2WCA-2	1000

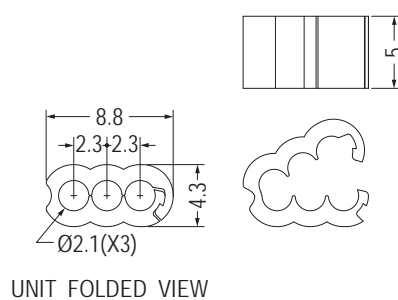

Part No.	Package
3WC-2	1000

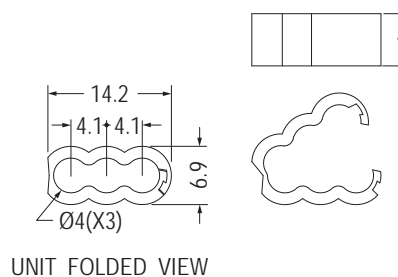

Part No.	Package
3WC-4	1000

電線固定扣 CABLE CLAMP

用途：固定電線於機器中，防止電線斷路。



- Material: Nylon 66 (UL)
- Flame Class: 94V-2/94V-0
- Color: Natural/Black
- Unit: mm

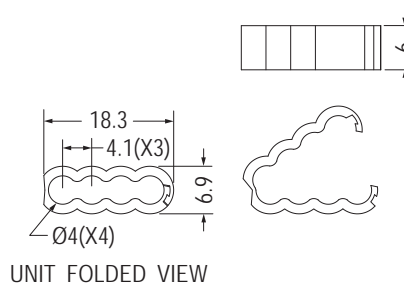

Part No.	Package
4WC-4	1000

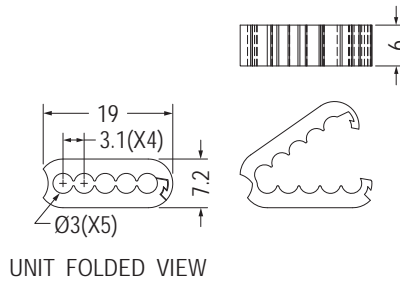

- Color: Gray

Part No.	Package
5WC-3	1000

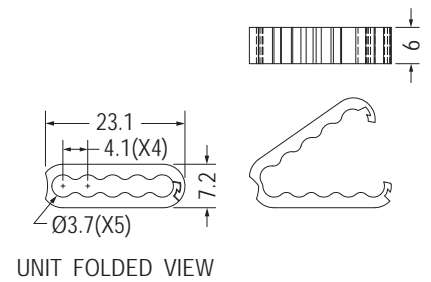

- Color: Gray

Part No.	Package
5WC-3.5	1000



- Material: Nylon 66 (UL)
- Flame Class: 94V-2/94V-0
- Color: Natural/Black
- Unit: mm

用途：固定電線於機器中，整齊美觀。

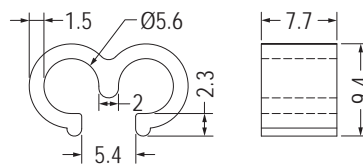

Part No.	Package
MUB-1	1000

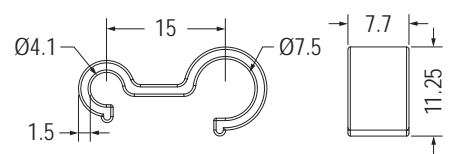

Part No.	Package
MUB-2	1000

C13 AC 電源扣件 AC POWER RETAINER C13

用途：可固定電源線，避免不小心脫落，造成電腦停機。



- Material: Nylon 66 (UL)
- Flame Class: 94V-2/94V-0
- Color: Gray
- Unit: mm

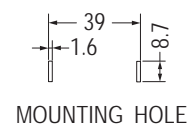
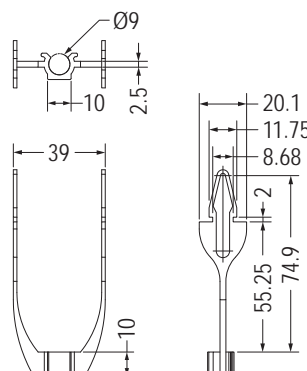

Part No.	Package
EMD-512	250

電線固定扣 CABLE CLAMP

用途：使用螺絲將電線固定於機器中，固定電線不易鬆動。

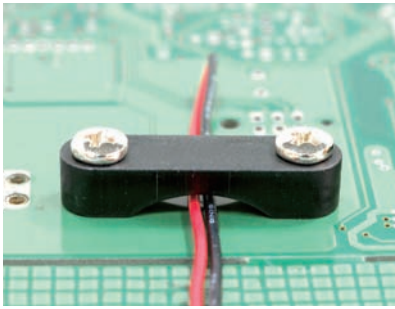

- Material: Nylon 66 (UL)
- Flame Class: 94V-2/94V-0
- Color: Natural/Black
- Unit: mm

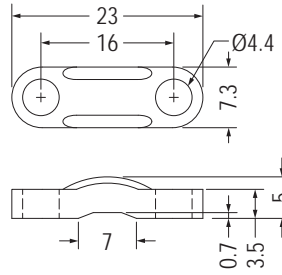

- Flame Class: 94HB

Part No.	Package
CLT-4	1000

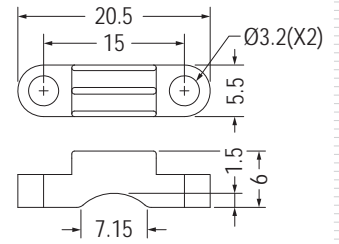

- Material: Nylon 6 (UL)
- Flame Class: 94V-2
- Color: Natural

Part No.	Package
CLT-19	1000

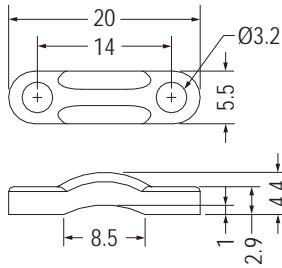

Part No.	Package
CLT-2	500

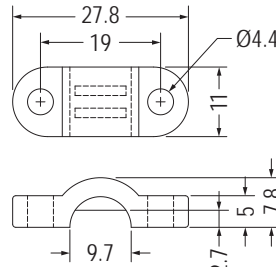

- Material: Nylon 66 (UL)/ABS (UL)/PC+ABS (UL)
- Flame Class: 94HB/94V-2/94V-0

Part No.	Package
CLT-1	500

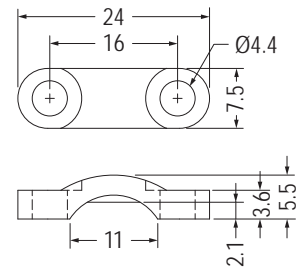

- Flame Class: 94HB
- Color: Black

Part No.	Package
CLT-5	1000

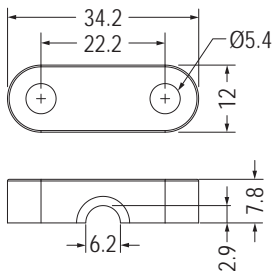

- Material: ABS (UL)
- Flame Class: 94HB
- Color: Black

Part No.	Package
CLT-8	1000

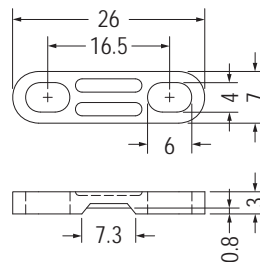

- Flame Class: 94HB
- Color: Black

Part No.	Package
CLT-6	1000

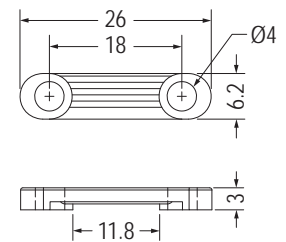

- Material: PBT (UL)
- Flame Class: 94V-0
- Color: Natural

Part No.	Package
CLT-18	500

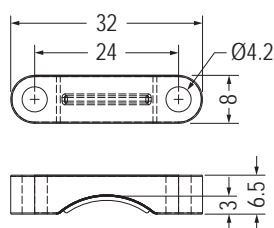

Part No.	Package
CLT-14	1000

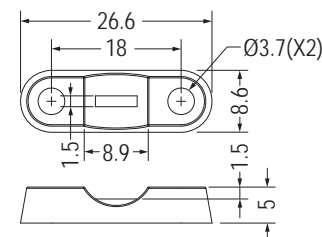

Part No.	Package
CLT-20	1000

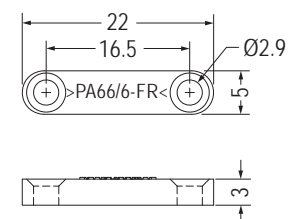

Part No.	Package
CLT-10	1000

電線固定夾片 CABLE CLAMP

用途：使用螺絲將電線固定於機器中，固定電線不易鬆動。



- Material: Nylon 66 (UL)
- Flame Class: 94V-2/94V-0
- Color: Natural/Black/Gray
- Unit: mm

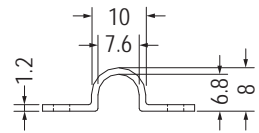
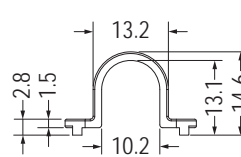
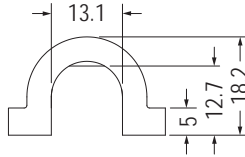
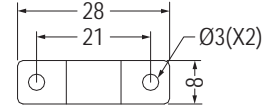
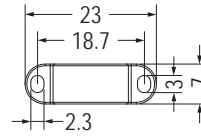
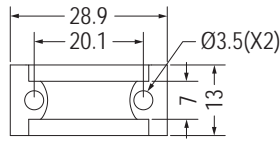

Part No.	Package
CLT-7	500

Part No.	Package
CLT-9	1000

Part No.	Package
CLM-7.5	1000



- Material: Zinc Plated Steel
- Unit: mm

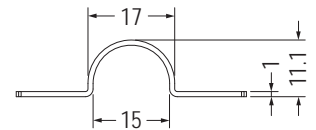
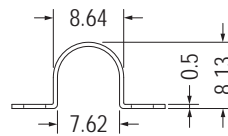
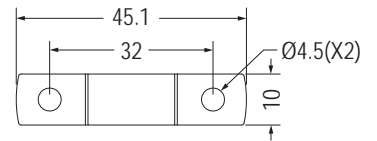
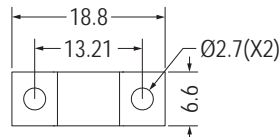

Part No.	Package
EM-514H	1000

• Material: Aluminum

Part No.	Package
EM-646	1000

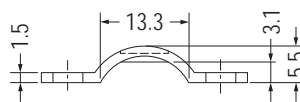
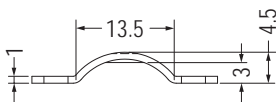
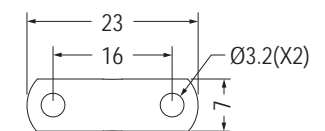
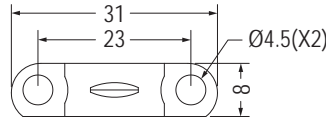
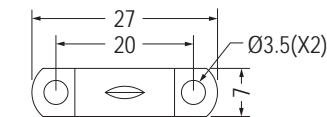

- Material: Steel

Part No.	Package
CLS-1	1000

- Material: Steel

Part No.	Package
CLS-2	1000

Part No.	Package
CLT-16	1000

軌道式線扣組 CABLE CARRIER

用途：用於電線固定於軌道上。

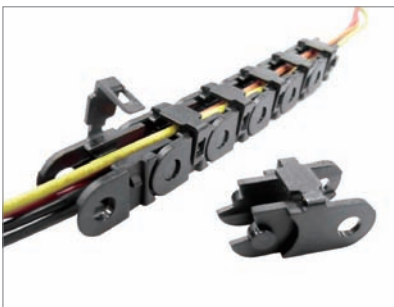

- Material: Nylon 66 (UL)
- Flame Class: 94V-2/94V-0
- Color: Black
- Unit: mm
- Patented (專利品)
- USA Patented (美國專利品)

- 線材請勿超過橫切面的70%
- Please don't fill the cross-section more than 70%.

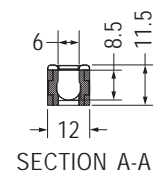
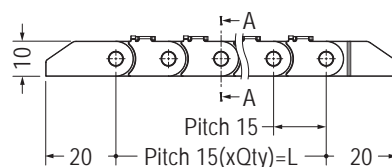
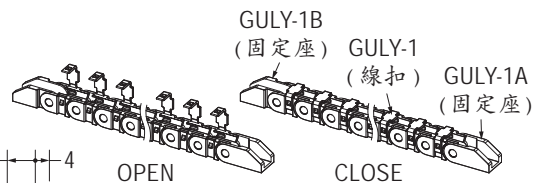
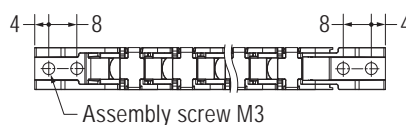

Part No.
GULY-1AB-XXF

軌道式線扣組 CABLE CARRIER

用途：用於電線固定於軌道上。



- Material: Nylon 66 (UL)
- Flame Class: 94V-2/94V-0
- Color: Black
- Unit: mm
- Patented (專利品)
- USA Patented (美國專利品)

- 線材請勿超過橫切面的70%
- Please don't fill the cross-section more than 70%.

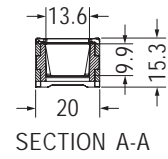
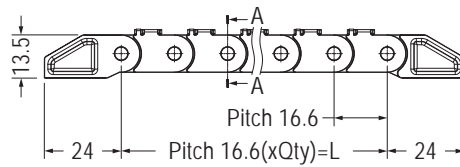
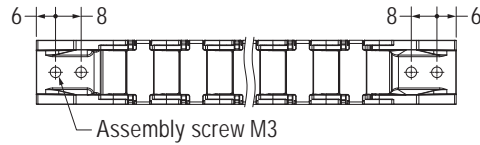
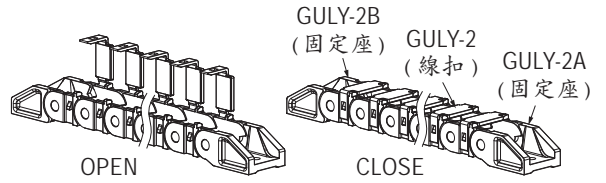

Part No.
GULY-2AB-XXF

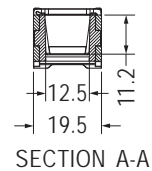
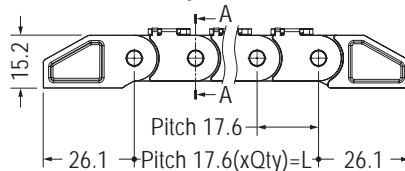
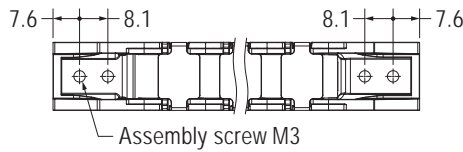
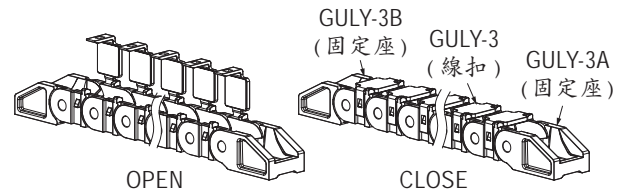

Part No.
GULY-3AB-XXF

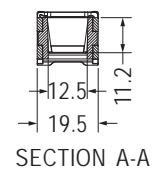
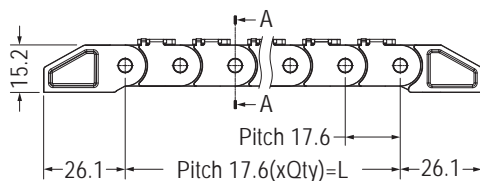
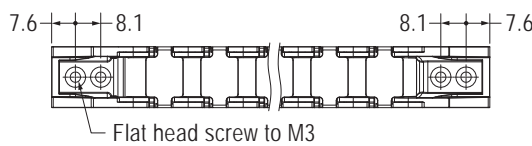
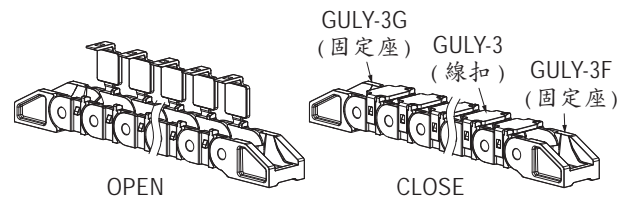
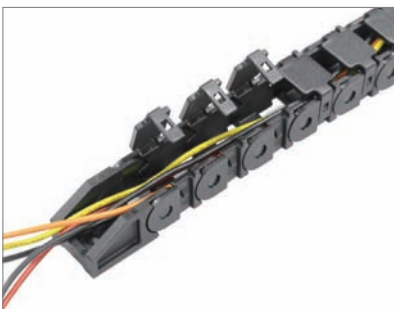

Part No.
GULY-3FG-XXF

軌道式線扣組 CABLE CARRIER

用途：用於電線固定於軌道上。

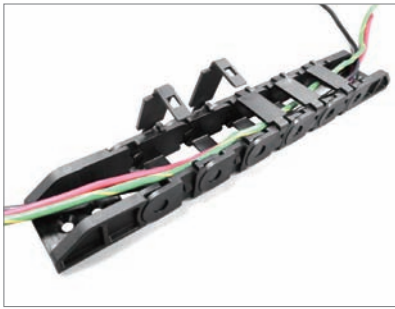

- Material: Nylon 66 (UL)
- Flame Class: 94V-2/94V-0
- Color: Black
- Unit: mm
- Patented (專利品)
- USA Patented (美國專利品)

- 線材請勿超過橫切面的70%
- Please don't fill the cross-section more than 70%.

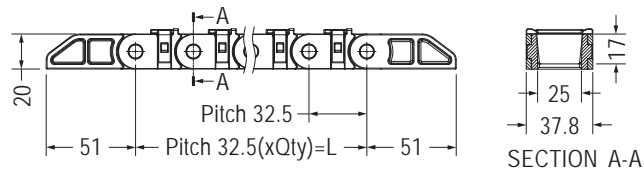
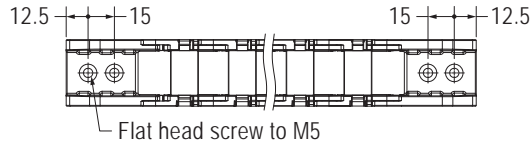
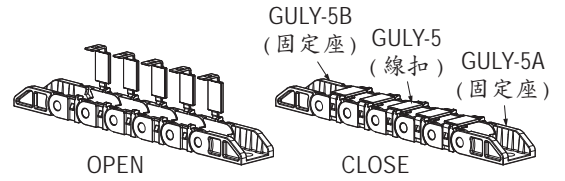

Part No.
GULY-5AB-XXF

4

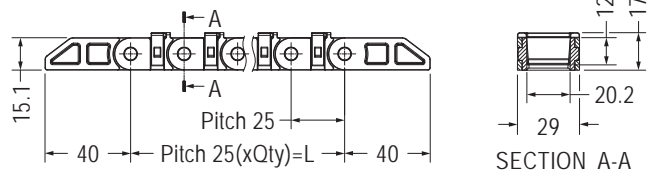
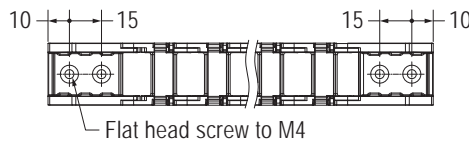
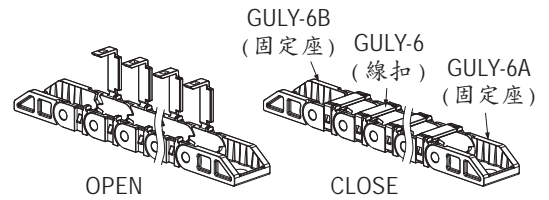

Part No.
GULY-6AB-XXF

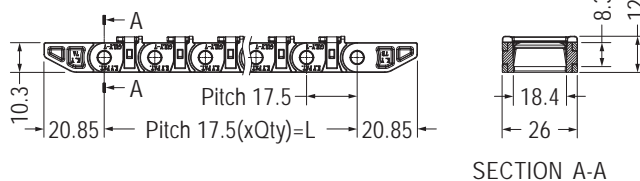
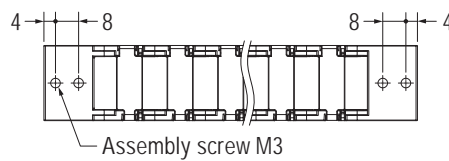
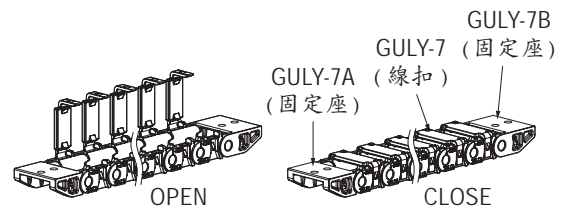

Part No.
GULY-7AB-XXF

軌道式線扣組 CABLE CARRIER

用途：用於電線固定於軌道上。



- Material: Nylon 66 (UL)
- Flame Class: 94V-2/94V-0
- Color: Black
- Unit: mm
- Patented (專利品)
- USA Patented (美國專利品)

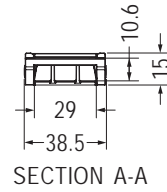
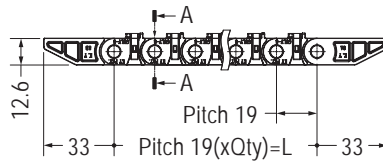
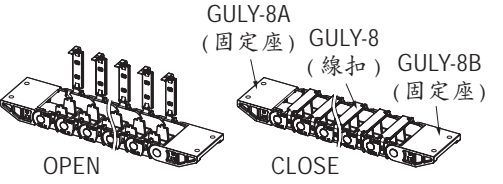

Part No.
GULY-8AB-XXF

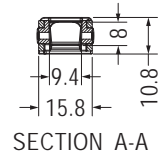
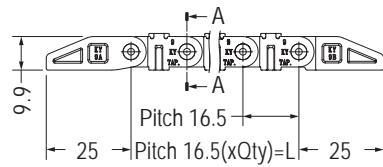
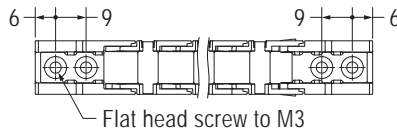
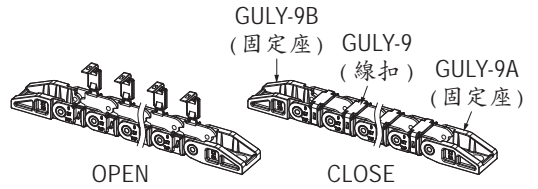

Part No.
GULY-9AB-XXF

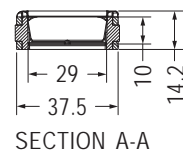
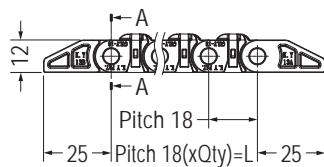
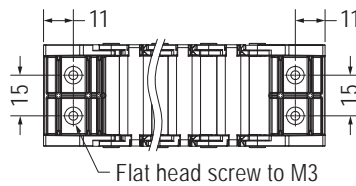
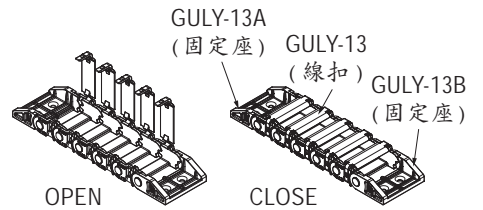
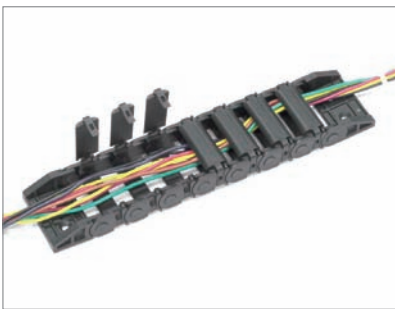

Part No.
GULY-13AB-XXF

軌道式線扣組 CABLE CARRIER

用途：用於電線固定於軌道上。

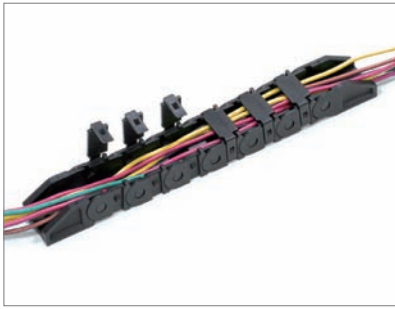

- Material: Nylon 66 (UL)
- Flame Class: 94V-2/94V-0
- Color: Black
- Unit: mm
- Patented (專利品)
- USA Patented (美國專利品)

- 線材請勿超過橫切面的70%
- Please don't fill the cross-section more than 70%.

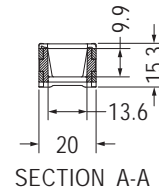
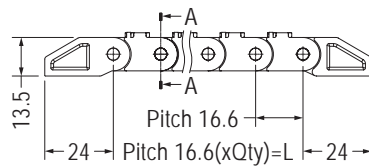
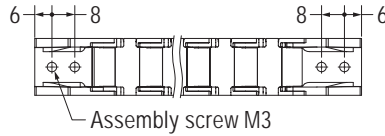
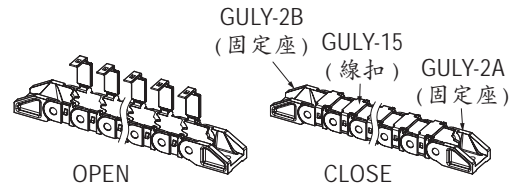

Part No.
GULY-15AB-XXF

4

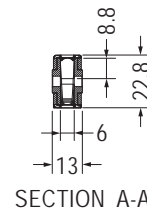
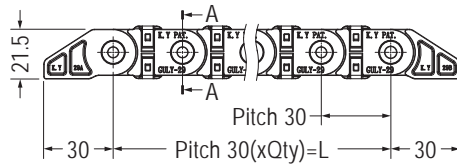
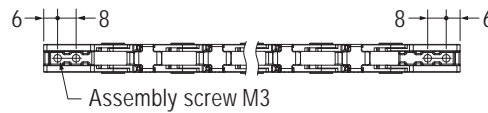
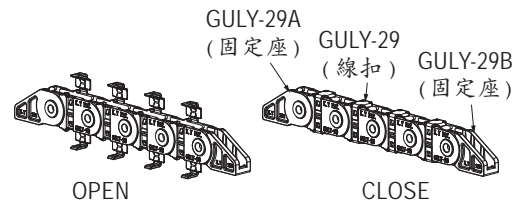
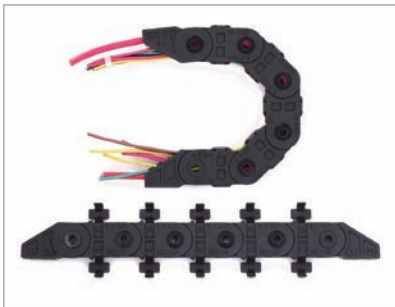

Part No.
GULY-29AB-XXF

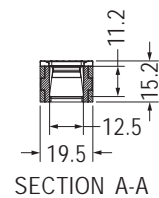
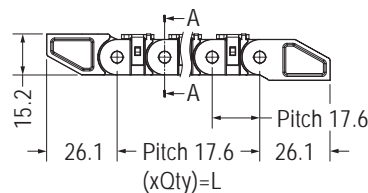
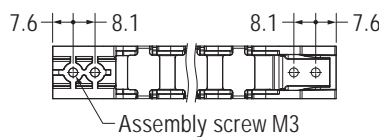
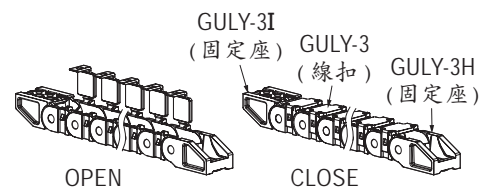

Part No.
GULY-3HI-XXCF

軌道式線扣組 CABLE CARRIER

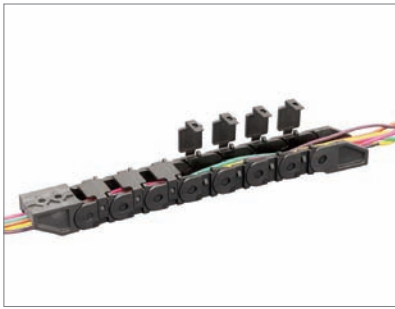

- Material: Nylon 66 (UL)
- Flame Class: 94V-2/94V-0
- Color: Black
- Unit: mm
- Patented (專利品)
- USA Patented (美國專利品)

用途：用於電線固定於軌道上。

- 線材請勿超過橫切面的70%
- Please don't fill the cross-section more than 70%.

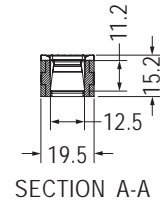
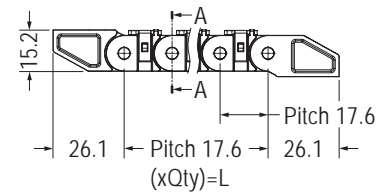
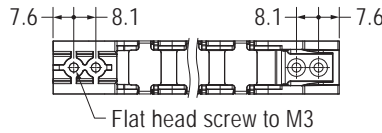
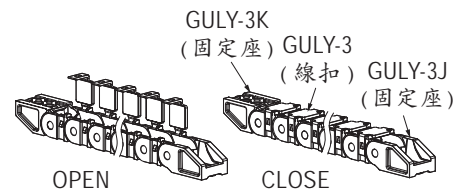

Part No.
GULY-3JK-XXCF

旋轉軌道式線扣組 ROTARY CABLE CARRIER



- Material: Nylon 66 (UL)
- Flame Class: 94V-2/94V-0
- Color: Black
- Unit: mm
- Patented (專利品)
- USA Patented (美國專利品)

用途：用於電線固定於軌道上，可轉方向，方便使用。

- 線材請勿超過橫切面的70%
- Please don't fill the cross-section more than 70%.

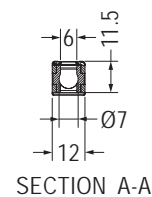
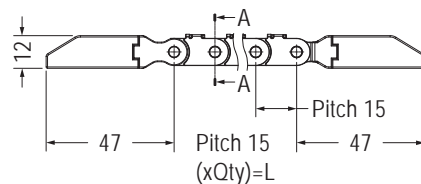
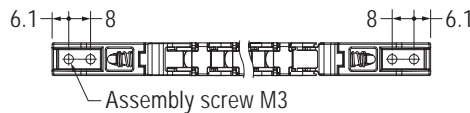
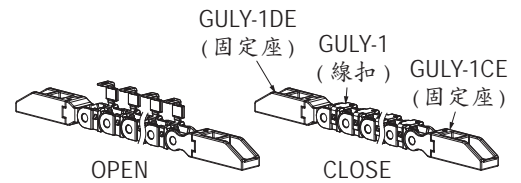

Part No.
GULY-1CDE-XXF



使用說明
Installation Step

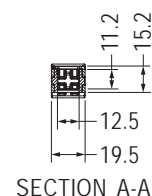
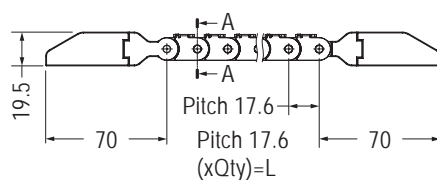
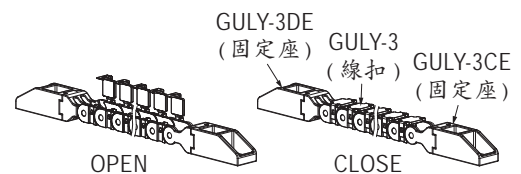

Part No.
GULY-3CDE-XXF

軌道式線扣組 CABLE CARRIER

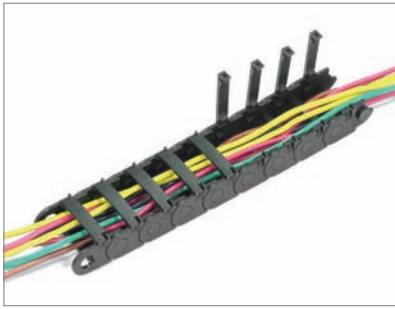

- Material: Nylon 66 (UL)
- Flame Class: 94V-2/94V-0
- Color: Black
- Unit: mm
- Patented (專利品)
- USA Patented (美國專利品)

用途：用於電線固定於軌道上。

- 線材請勿超過橫切面的70%
- Please don't fill the cross-section more than 70%.

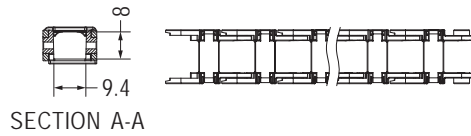

SECTION A-A

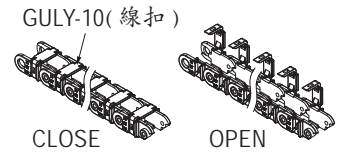
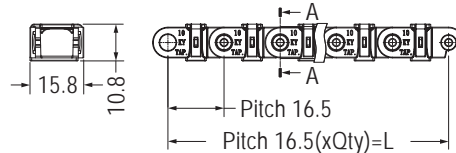

Part No.
GULY-10-XXF

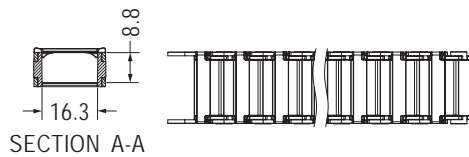

SECTION A-A

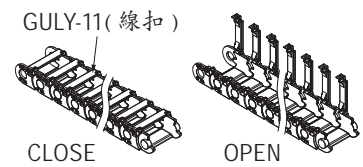
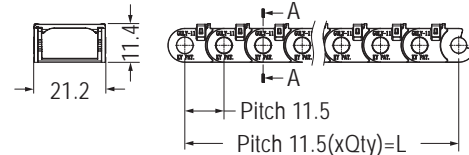

Part No.
GULY-11-XXF

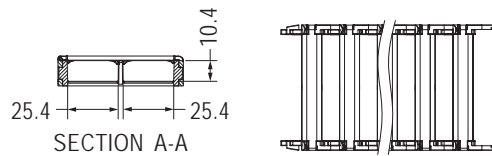

SECTION A-A

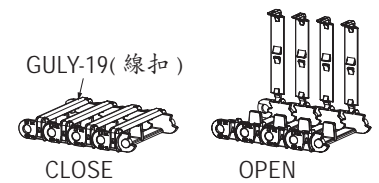
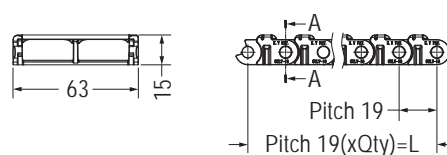

Part No.
GULY-19-XXF

電線束線環 HOSE CLAMP



- Material: POM (UL)/POM/Nylon 66 (UL)
- Flame Class: 94HB/94V-2/94V-0
- Color: Natural/Black
- Unit: mm

用途：用於配線中，電線整理美觀不脫落。

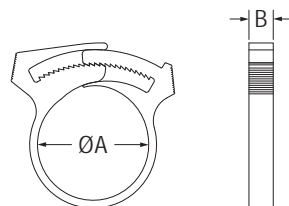

Part No.	A(MIN.~MAX.)	B	Package
SMAP-5	8.0~9.0	6.0	500
SMAP-6	10.0~11.0	5.5	
SMAP-7	10.0~12.5	5.9	
SMAP-7S	8.0~10.0	6.5	
SMAP-10	14.0~16.0	5.9	
SMAP-11	11.0~12.0	5.5	250
SMAP-16	17.5~21.0	5.9	
SMAP-18	20.0~22.0	6.0	
SMAP-19	21.0~24.0	5.9	
★SMAP-22	23.3~26.65	5.9	
SMAP-24	25.0~27.0	7.4	
SMAP-24S	22.2~25.4	5.6	
SMAP-28	27.0~32.0	7.3	
SMAP-32	29.0~34.0	7.3	
SMAP-34	33.0~37.0	7.4	

防高壓線環 F.B.T CLIP

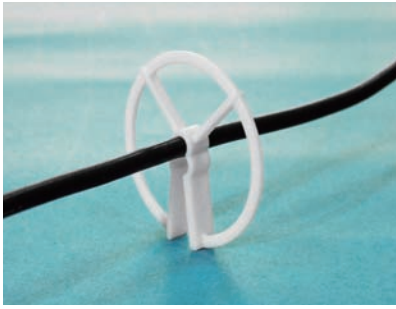

- Material: Nylon 66 (UL)
- Flame Class: 94V-2/94V-0
- Color: Natural
- Unit: mm

用途：保護C.R.T高壓與管壁間之絕緣，使用方便。

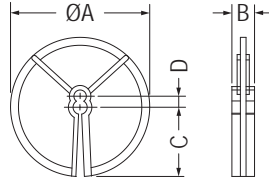

FIT CABLE: F

Part No.	A	B	C	D	F	Package
FBT-1	49.5	7.8	22.0	5.0	4.5~5.3	100
FBT-2	49.2	7.8	22.0	5.0	3.5~4.5	
FBT-3	50.2	7.4	23.0	5.0	2.5~3.5	
FBT-4	49.5	8.0	22.5	4.6	4.0~4.5 or 5.0~5.5	
FBT-5	49.2	8.0	22.0	4.7	3.7~4.2 or 4.5~5.2	

光纖固定座 FIBER CABLE HOUSING

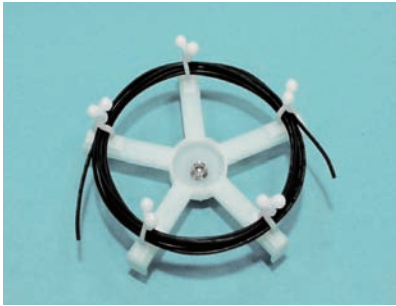

- Material: Nylon 66 (UL)
- Flame Class: 94V-2
- Color: Natural
- Unit: mm

用途：配合THA-、CH-系列產品使用，可固定光纖，不折斷，不衰減。

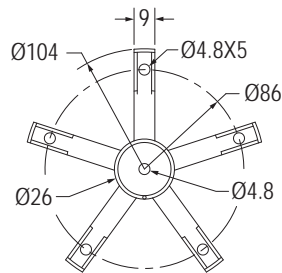

3M DOUBLE ADHESIVE TAPE

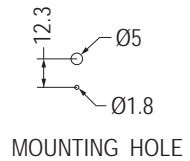
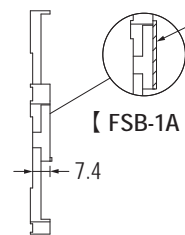

Part No.	Fitting	Package
FSB-1	Screw	50
FSB-1A	Adhesive	



- Material: Nylon 66 (UL)
- Flame Class: 94V-2
- Color: Natural
- Unit: mm

用途：配合WPEM系列產品使用，可固定光纖，不折斷，不衰減。

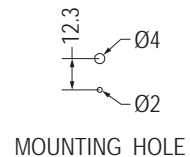
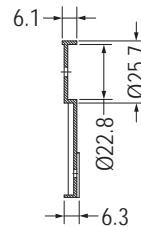
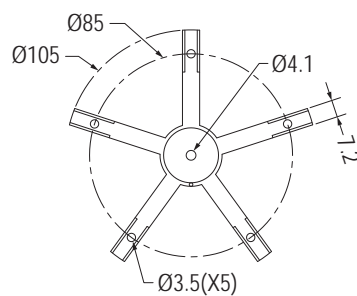

Part No.	Package
FSB-2	50

光纖固定座 FIBER CABLE HOUSING

用途：保護和固定光纖，不折斷，不衰退。

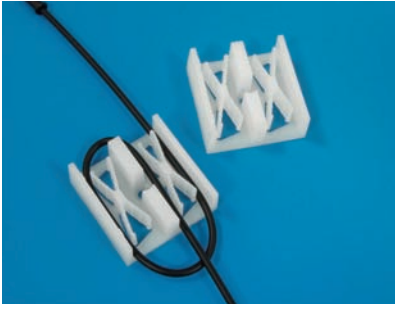

- Material: Nylon 66 (UL)
- Flame Class: 94V-2/94V-0
- Color: Black
- Unit: mm

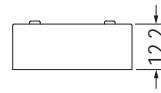
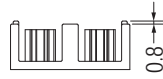
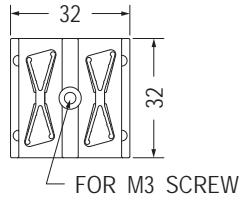

Part No.	Package
OFS-1	200

5



- 護線環
Snap Bushing
- 橡膠線環
Grommet
- 扣式塞頭
Hole Plug
- 電源線扣
Strain Relief Bushing
- 電線束線帶
Cable Tie
- PVC套管
PVC Tube
- 熱縮套管
Heat Shrink Tubing
- 把手
Handle
- 外箱扣
Box Handle
- 黏貼標誌貼紙
Wire Label



護線環 SNAP BUSHING

用途：用於機殼的電線出線口，保護電線不受機殼刮傷，裝配容易。

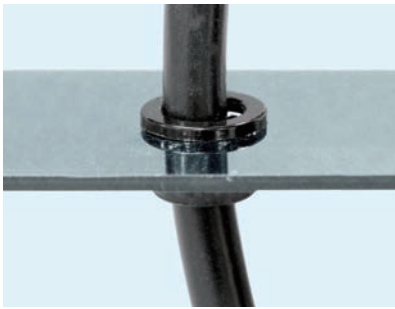

- Material: Nylon 66 (UL)
- Flame Class: 94V-2/94V-0
- Color: Natural/Black
- Unit: mm

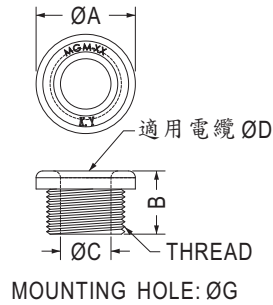

Part No.	A	B	C	D	G	Thread	搭配螺帽	Package
MGM-10	15.0	12.0	7.0	6.5	10.0~10.5	M10X1.5P	M-10N	500
MGM-12	18.0	12.0	8.8	8.5	12.0~12.5	M12X1.5P	KGB12-07A	
MGM-16	21.7	13.5	11.2	11.0	16.0~16.5	M16X1.5P	KGB16-10A	
MGM-20	26.8	13.5	15.2	15.0	20.0~20.5	M20X1.5P	KGB20-14A	
MGM-25	32.6	14.0	19.2	19.0	25.0~25.5	M25X1.5P	KGB25-16A	100
MGM-32	42.0	19.0	26.2	26.0	32.0~32.5	M32X1.5P	KGB32-25A	



- Material: Nylon 66 (UL)
- Flame Class: 94V-2/94V-0
- Color: Black
- Unit: mm

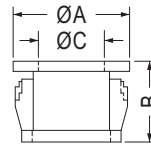
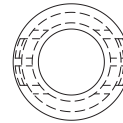

MOUNTING HOLE: ØG
THICKNESS: T

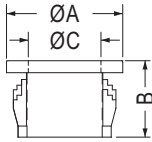
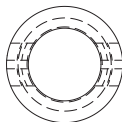

MOUNTING HOLE: ØG
THICKNESS: T



Part No.	A	B	C	G	T	Package
312-3	9.5	8.2	5.2	8.0	0.8~1.8	1000
375-4	12.0	10.3	6.6	9.5	0.8~3.3	
0811	13.6	10.3	8.4	11.1	0.8~3.3	
0813	15.1	10.3	9.8	12.7	0.8~3.3	
1216	18.2	10.3	12.8	16.0	0.8~3.3	

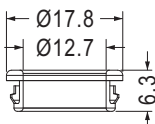
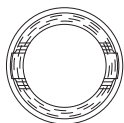

MOUNTING HOLE Ø15.8
THICKNESS 0.8~1.6



Part No.	Package
NB-1215	1000

Part No.	A	B	C	G	T	Package
NB-0710	12.1	6.6	7.2	10.0	0.8~1.8	1000
NB-1217	20.0	10.3	12.7	17.5	0.8~3.3	200
NB-1419	21.5	11.3	14.3	19.0	0.8~3.3	
NB-1722	25.1	11.2	18.6	22.2	0.8~3.3	100
NB-1922	23.8	6.3	19.0	22.2	0.8~1.6	
NB-1925	28.0	10.8	19.4	25.4	0.8~3.3	
NB-2428	31.5	11.3	24.1	28.0	1.0~3.3	200
NB-2430	34.0	11.7	24.5	30.1	0.8~3.3	
NB-2535	37.8	11.3	25.8	35.0	0.8~3.5	
NB-2935	37.8	11.3	29.7	35.0	0.8~3.5	
NB-2634	38.0	11.5	26.2	34.2	1.0~3.1	
NB-3034	38.0	11.5	30.4	34.2	1.0~3.1	
NB-3338	41.2	11.6	33.3	38.0	1.0~3.3	100
NB-4150	53.8	11.4	41.8	50.8	0.8~3.2	
NB-4450	53.8	11.4	44.3	50.8	0.8~3.2	
NB-4757	63.0	18.1	47.3	57.1	6.35	
NB-5063	67.5	18.1	50.5	63.5	6.35	
NB-5563	67.5	18.1	55.5	63.5	6.35	

開口式護線環 SNAP BUSHING

用途：用於機殼的電線出口口，保護電線不受機殼刮傷，裝配容易。

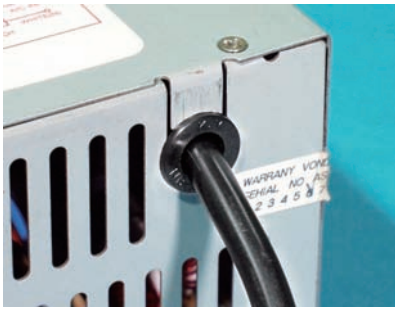

- Material: Nylon 66 (UL)
- Flame Class: 94V-2/94V-0
- Color: Black
- Unit: mm
- 採開口式量法

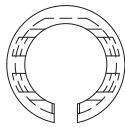

MOUNTING HOLE: ØG
THICKNESS: T

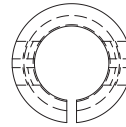

MOUNTING HOLE: ØG
THICKNESS: T



Part No.	A	B	C	G	T	Package
NB-09	12.4	6.0	7.6	9.5	0.8~1.2	1000
NB-12	16.8	7.3	10.8	12.7	0.8~1.2	
NB-16	20.3	7.3	14.1	15.9	0.8~1.0	
NB-19	22.5	7.3	16.5	19.0	0.8~1.0	500
NB-22	26.0	7.3	20.0	22.0	0.8~1.0	
NB-25	28.6	7.9	22.0	25.4	0.8~1.6	

Part No.	A	B	C	G	T	Package	UL
0609C	11.9	6.5	7.3	9.5	0.6~1.6	1000	UL
0813C	15.0	9.8	9.7	12.7	0.8~3.3		UL
★1014C	16.6	10.3	10.6	14.3	0.8~3.2		
1216C	18.4	10.4	12.8	15.9	0.8~3.3		UL
1419C	20.7	10.4	15.1	19.0	0.8~3.3		UL



- Material: Nylon 66 (UL)
- Flame Class: 94V-2/94V-0
- Color: Natural/Black
- Unit: mm

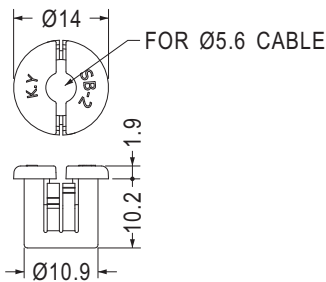

MOUNTING HOLE Ø11.1
THICKNESS 0.6~3.2

Part No.	Package
SB-2	1000

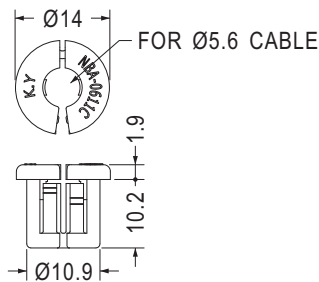

MOUNTING HOLE Ø11.1
THICKNESS 0.6~3.2

Part No.	Package
NBA-0611C	1000

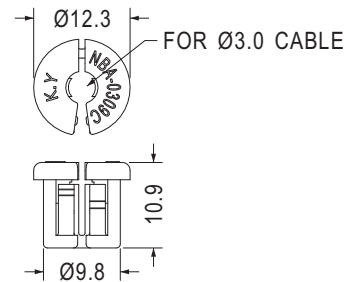

MOUNTING HOLE Ø9.5
THICKNESS 0.6~3.2

Part No.	Package
NBA-0309C	1000

開口式護線環 SNAP BUSHING

用途：用於機殼的電線出線口，保護電線不受機殼刮傷，裝配容易。

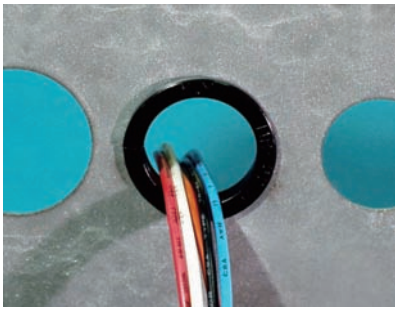

- Material: Nylon 66 (UL)
- Flame Class: 94V-2/94V-0
- Color: Black
- Unit: mm
- 採開口式量法

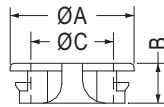
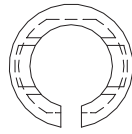

MOUNTING HOLE: ØG
THICKNESS: T

Part No.	A	B	C	G	T	Package
NB-07A	10.4	4.8	6.0	7.0	0.8~1.0	1000
NB-12A	16.2	5.2	10.8	12.7	0.8~1.0	
NB-16A	19.3	5.2	13.0	16.0	0.8~1.0	
NB-19A	23.0	5.5	15.6	19.0	0.8~1.0	
NB-21A	25.0	5.6	19.0	21.0	0.8~1.0	
NB-22A	25.8	5.5	19.5	22.0	0.8~1.0	500
NB-23A	26.4	5.5	20.4	23.0	0.8~1.0	
NB-24A	27.0	5.3	20.8	24.0	0.8~1.0	
NB-27A	34.6	6.0	27.0	27.0	0.8~1.0	
NB-29A	34.0	7.0	26.3	29.0	0.8~1.0	
NB-30A	36.25	7.0	28.0	30.0	0.8~1.0	
NB-32A	36.9	6.7	30.0	32.0	0.8~1.2	

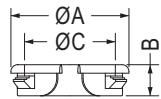
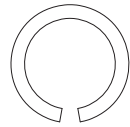

MOUNTING HOLE: ØG
THICKNESS: T

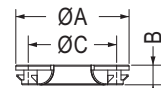

MOUNTING HOLE: ØG
THICKNESS: 0.8~1.2



Part No.	A	B	C	G	T	Package
NB-22T	26.4	5.5	20.3	22.0	0.6~0.8	500
NB-25T	30.3	8.0	23.3	25.4	0.6~1.4	
NB-25TS	30.3	8.0	23.3	25.0	0.6~1.6	

Part No.	A	B	C	G	Package
NB-27C	34.6	6.0	27.0	27.0	500
NB-29C	34.6	7.0	27.0	29.0	
NB-32C	36.9	6.7	30.0	32.0	

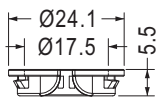

MOUNTING HOLE Ø19.5
THICKNESS 0.6

Part No.	Package
NB-19.5T	500

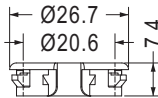
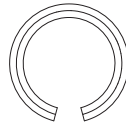

MOUNTING HOLE Ø22.0
THICKNESS 0.8~1.0

Part No.	Package
NB-22U	500

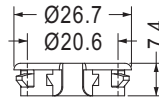
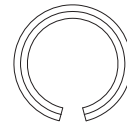

MOUNTING HOLE Ø22.0
THICKNESS 0.6~0.8

Part No.	Package
NB-22J	500



- Material: Nylon 66 (UL)
- Flame Class: 94V-2/94V-0
- Color: Natural
- Unit: mm
- 採開口式量法

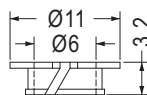
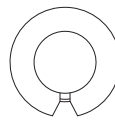

MOUNTING HOLE Ø7.25
THICKNESS 1.1

Part No.	Package
NC-7	1000

- Material: Nylon 66 (UL)/POM
- Flame Class: 94HB/94V-2/94V-0
- Color: Natural/Black
- Unit: mm
- 採開口式量法

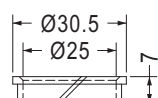
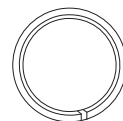

MOUNTING HOLE Ø28.0

Part No.	Package
NC-28A	500

開口式護線環 SNAP BUSHING

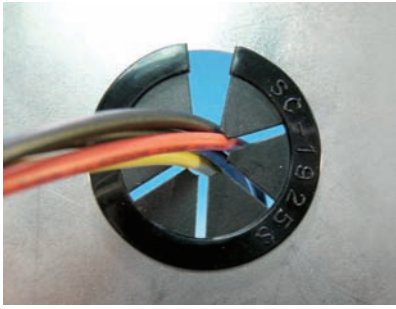

- Material: Nylon 66 (UL)
- Flame Class: 94V-2/94V-0
- Color: Black
- Unit: mm
- 採開口式量法

用途：用於機殼的電線出線口，保護電線不受機殼刮傷，裝配容易。

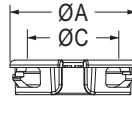

MOUNTING HOLE: ØG
THICKNESS: T

[SC-1421S, SC-1422S]

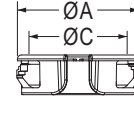
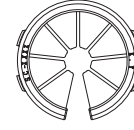

MOUNTING HOLE: ØG
THICKNESS: T

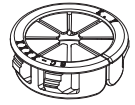

CLOSE

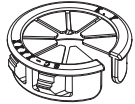

OPEN

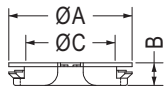
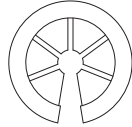

MOUNTING HOLE: ØG
THICKNESS: T

Part No.	A	B	C	G	T	Package
SC-1925S	29.0	5.3	21.0	25.4	0.8~1.0	250
SC-1925A	29.0	11.4	21.0	25.4	0.8~3.0	
SC-1319A	22.6	9.75	15.3	19.0	0.8~3.2	500

Part No.	A	B	C	G	T	Package
SC-0712	15.3	9.8	10.3	12.7	0.8~3.3	1000
SC-1115	18.8	10.3	13.8	15.9	0.8~3.3	
SC-1421S	24.5	8.9	17.85	21.0	0.6~1.6	250
SC-1422	25.5	10.3	18.5	22.2	0.8~3.3	
SC-1422S	25.5	7.0	18.5	22.2	0.6~1.2	200
SC-2027	31.5	10.3	25.5	27.8	0.8~3.3	
SC-2331	38.7	10.3	29.3	31.8	0.8~3.3	
SC-2534	39.2	10.3	31.2	34.9	0.8~3.3	
SC-2638	42.6	10.7	32.6	38.1	0.8~3.3	

護線環 SNAP BUSHING



- Material: Nylon 66 (UL)
- Flame Class: 94V-2/94V-0
- Color: Black
- Unit: mm

用途：用於機殼的電線出線口，保護電線不受機殼刮傷，裝配容易。

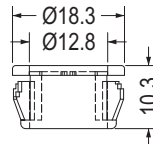
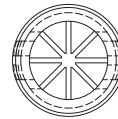

MOUNTING HOLE Ø15.9
THICKNESS 3.2

Part No.	Package
SC-1216	1000

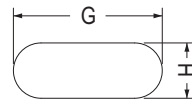
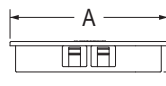
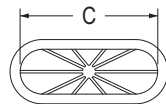

MOUNTING HOLE
THICKNESS: T

[NBR-7026, NBR-5520]

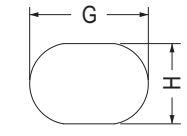
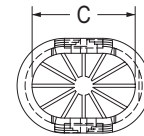

MOUNTING HOLE
THICKNESS: T

Part No.	A	B	C	G	H	T	Package
NBR-3025	34.0	6.5	26.7	30.5	25.0	0.8~1.5	1000
NBR-3725	41.5	14.3	32.2	37.0	25.0	1.2~3.0	500
NBR-5030S	54.2	7.5	44.9	50.0	30.0	0.8~1.6	100
NBR-5030	54.2	14.3	44.9	50.0	30.0	1.2~3.0	
NBR-5520	59.2	14.3	49.9	55.0	20.0	1.2~3.2	
NBR-7026	74.2	14.3	64.7	70.0	26.0	1.2~3.2	
NBR-8054	84.5	14.3	71.4	80.0	54.0	1.2~3.0	50

護線環 SNAP BUSHING

用途：用於機殼的電線出線口，保護電線不受機殼刮傷，裝配容易。

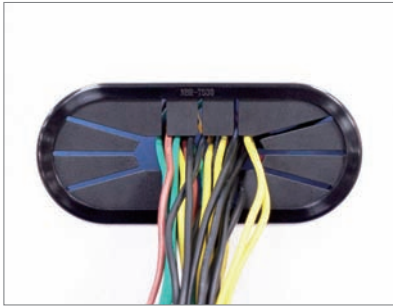

- Material: Nylon 66 (UL)
- Flame Class: 94V-2/94V-0
- Color: Black
- Unit: mm

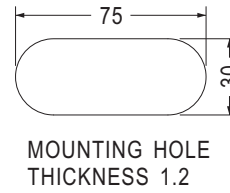
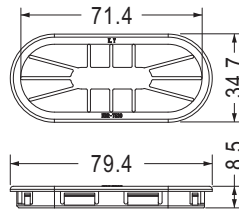

MOUNTING HOLE THICKNESS 1.2

Part No.	Package
NBR-7530	100

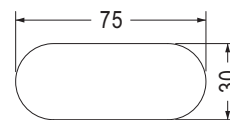
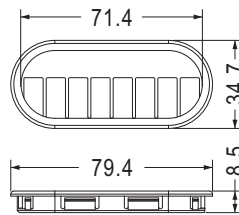

MOUNTING HOLE THICKNESS 1.2

Part No.	Package
NBR-7530-2	100

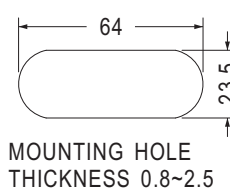
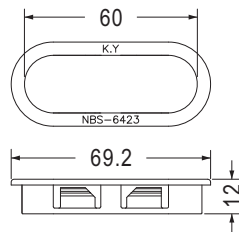

MOUNTING HOLE THICKNESS 0.8~2.5



Part No.	Package
NBS-6423	100

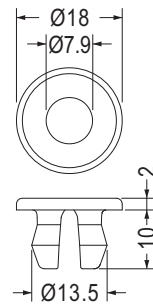

MOUNTING HOLE Ø12.0 THICKNESS 4.6

Part No.	Package
SBA-1	1000

線環 GROMMET

用途：用於電線之絕緣。



- Material: POM (UL)
- Flame Class: 94HB
- Color: Natural
- Unit: mm

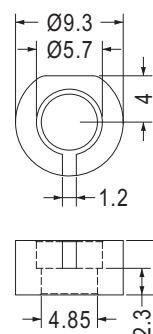

Part No.	Package
010406	1000

橡膠線環 GROMMET

用途：用於機殼的電線出線口，保護電線不受機殼刮傷，裝配容易。



- Material: Rubber/Silicon Rubber
- Color: Black
- Unit: mm

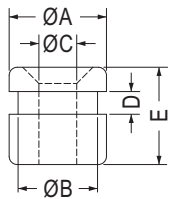
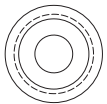
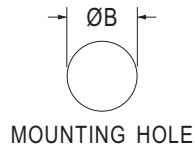
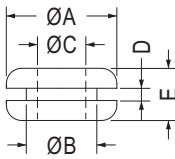
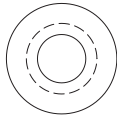

【 GM-16 】

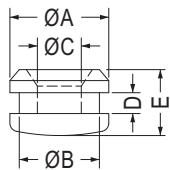

【 GM-17 】

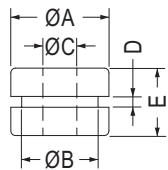
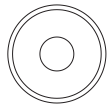

【 GM-38, GM-46, GM-71, GM-81 】

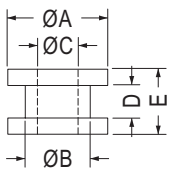
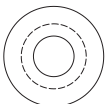

【 GM-40, GM-44, GM-55, GM-60, GM-65 】

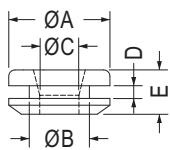

【 GM-45 】

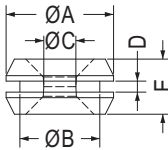
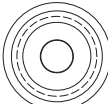

【 GM-49, GM-98 】

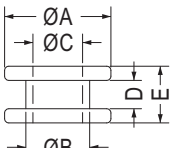

【 GM-53 】

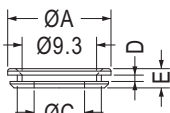

【 GM-64 】

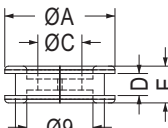

【 GM-68 】

Part No.	A	B	C	D	E	Package
GM-1	8.0	4.8	3.2	1.6	6.4	2000
GM-1A	9.5	6.4	4.0	1.6	6.4	
GM-2	10.8	8.0	4.5	1.6	4.5	1000
GM-3	14.4	9.5	6.3	1.6	7.0	
GM-3A	14.2	11.0	8.0	1.6	4.8	
GM-4	17.5	12.7	9.5	1.6	6.8	
GM-5	22.0	17.5	14.2	1.6	4.8	500
GM-6	22.0	19.0	16.0	1.6	5.5	
GM-6A	25.0	19.5	18.0	1.6	6.0	
GM-7	31.4	25.2	18.5	1.6	8.0	250
GM-8	19.5	14.0	6.0	1.0	7.0	1000
GM-9	15.9	12.7	9.5	1.6	6.4	
GM-11	7.9	4.8	3.2	1.6	4.8	2000
GM-14	17.46	11.11	7.94	2.38	8.73	500
GM-15	10.8	8.0	5.0	1.6	4.5	2000
GM-16	18.0	14.7	7.0	4.2	18.0	250
GM-17	18.0	14.6	8.0	3.8	12.0	500
GM-18	13.0	8.4	5.5	3.3	6.3	1000
GM-30	13.3	9.0	5.8	2.0	6.2	
GM-38	10.4	8.1	3.6	1.15	7.15	500
GM-40	24.0	17.5	14.0	3.0	7.0	
GM-42	27.0	20.8	12.7	1.6	7.8	250
GM-43	11.0	7.9	4.7	1.6	6.0	1000
GM-44	12.3	8.0	5.0	4.0	8.0	
GM-45	16.0	9.5	6.2	2.0	7.0	2000
GM-46	7.5	6.0	3.5	1.0	5.0	
GM-47	17.5	13.5	10.0	2.0	7.0	1000
GM-48	10.8	8.0	4.5	1.2	4.5	2000
GM-49	7.8	5.8	2.33	0.8	4.0	
GM-50	17.5	12.0	10.0	2.0	6.8	1000
GM-51	12.0	9.0	6.5	1.5	5.5	
GM-53	7.5	4.5	3.5	2.0	4.0	2000
GM-55	7.0	6.0	3.5	1.0	5.0	
GM-56	7.7	5.0	3.1	1.3	2.8	
GM-57	8.8	6.0	4.1	2.5	7.0	
GM-58	11.0	9.0	6.0	2.5	6.6	1000
GM-60	7.0	6.0	3.5	1.0	3.0	
GM-61	17.5	12.7	9.0	1.6	6.8	2000
GM-62	17.5	12.7	8.6	1.6	6.8	
GM-64	12.9	10.5	6.3	0.8	2.4	1000
GM-65	24.0	18.0	14.0	3.0	7.0	1000
GM-68	15.0	12.1	6.0	3.0	5.0	
GM-71	8.0	6.0	4.1	1.1	3.4	2000
GM-81	12.0	9.0	6.0	1.0	9.0	1000
GM-98	7.8	5.8	2.33	1.2	4.0	2000
GM-138	15.9	11.1	7.9	1.6	7.1	1000
GM-163	13.5	9.5	6.3	1.6	7.0	
GM-173	16.0	12.0	10.0	2.0	5.5	
★GM-177	10.1	7.0	5.0	1.5	4.8	

橡膠線環 GROMMET

用途：用於機殼的電線出線口，保護電線不受機殼刮傷，裝配容易。



- Material: Rubber/Silicon Rubber
- Color: Black
- Unit: mm

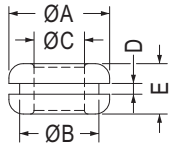
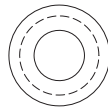

【 GM-69, GM-80, GM-147 】

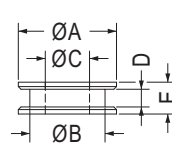
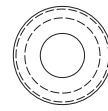

【 GM-99 】

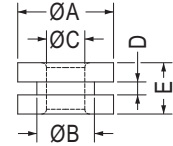
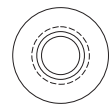

【 GM-106 】

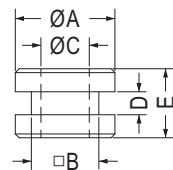

【 GM-154 】

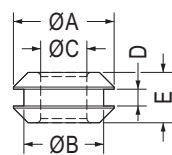
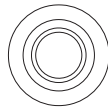

【 GM-159 】

Part No.	A	B	C	D	E	Package
GM-69	12.0	9.0	6.0	1.5	7.0	1000
GM-80	14.0	11.0	7.0	1.5	7.0	
GM-99	11.1	8.5	5.0	2.0	3.6	
GM-106	10.0	6.0	4.0	1.35	5.35	
GM-147	14.0	11.0	6.1	1.5	7.0	
GM-154	13.0	8.8	6.3	3.0	9.0	
GM-159	4.8	3.8	2.2	0.8	2.4	

5

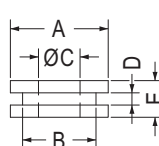
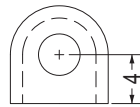

【 GM-35 】

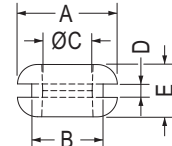
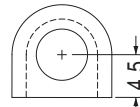

【 GM-39 】

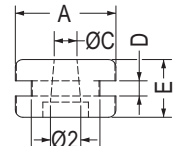
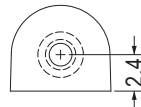

【 GM-70 】

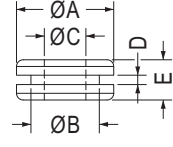
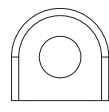

【 GM-137 】

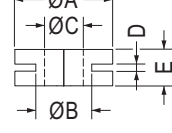

【 GM-139 】

Part No.	A	B	C	D	E	Package
GM-35	8.0	6.0	3.4	1.0	3.0	2000
GM-39	10.5	7.5	5.2	1.4	5.5	1000
GM-70	6.63	4.52	1.5	1.0	3.8	2000
GM-137	14.5	10.2	6.2	1.4	6.0	1000
GM-139	14.0	8.0	5.5	1.0	5.2	

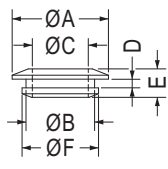
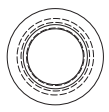

【 GM-136 】

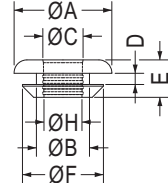
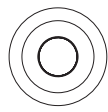

Part No.	A	B	C	D	E	F	H	Package
GM-67	17.5	9.5	7.2	2.0	6.7	14.5	6.8	1000
GM-73	17.5	9.5	6.8	2.0	6.7	14.5	6.3	
GM-74	18.5	10.5	8.2	2.0	6.7	15.5	7.8	
GM-75	19.5	11.5	9.2	2.0	6.7	16.5	8.8	
GM-77	21.8	13.8	11.2	2.0	6.7	18.8	10.8	
GM-82	17.5	9.5	6.2	2.0	6.7	14.5	5.8	
GM-96	17.5	11.5	7.2	2.0	6.7	16.5	6.8	
GM-97	17.5	11.5	7.6	2.0	6.7	16.5	7.2	2000
GM-136	12.0	8.5	6.7	1.1	3.6	9.5		

橡膠線環 GROMMET

用途：用於機殼的電線出線口，保護電線不受機殼刮傷，裝配容易。



裝配孔尺寸，僅供參考
Mounting holes are for reference only.

- Material: Rubber/Silicon Rubber
- Color: Black
- Unit: mm

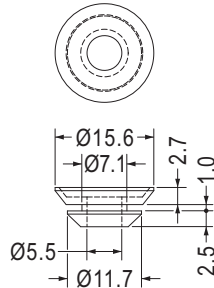

Part No.	Package
GM-158	1000

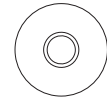

MOUNTING HOLE Ø15.0~Ø15.5

Part No.	Package
TF-346	500

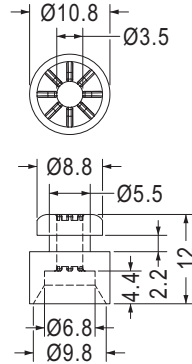

Part No.	Package
GM-92	1000

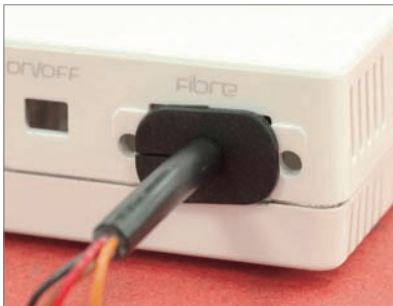

- Material: Silicon Rubber
- Color: Black
- Unit: mm

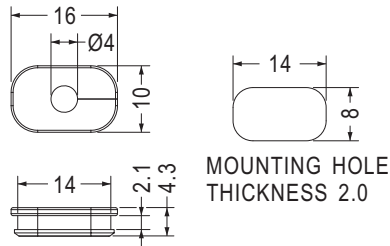

MOUNTING HOLE THICKNESS 2.0

Part No.	Package
TF-1333	1000

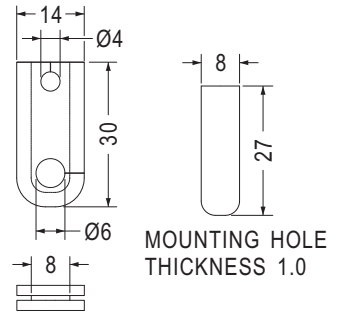

MOUNTING HOLE THICKNESS 1.0

Part No.	Package
GM-140	1000



- Material: Silicon Rubber (UL)
- Flame: 94V-0
- Color: Black
- Unit: mm

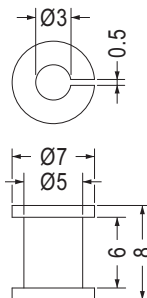

Part No.	Package
TF-1654	1000

導電護線環 CONDUCTIVE BUSHING

用途：用於機殼的電線出線口，保護電線不受機殼刮傷，裝配容易。



- Material: Silicon Rubber(UL)
- Flame: 94V-0
- Color: Black
- Unit: mm

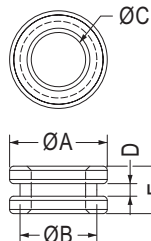

Part No.	A	B	C	D	E	Package
STGM-1	8.15	6.0	4.0	0.8	3.8	2000
STGM-2	7.0	5.5	3.9	0.9	3.4	

抗震線環 ANTI-VIBRATION GROMMET

用途：用於硬碟及精密零件之防震。
G: 為45度硬度，H: 為55度硬度

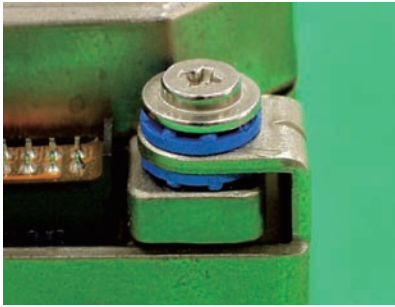

- Material: TPE (UL 94V-0 is optional)
G: Hardness is Shore A45
H: Hardness is Shore A55
- Color: Black/Blue
- Unit: mm

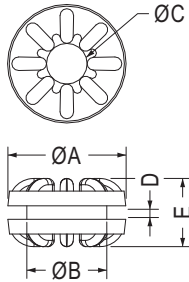

Part No.	A	B	C	D	E	Package
TGM-14	14.0	9.5	4.85	1.6	8.1	1000
TGM-15	14.0	11.0	4.85	1.6	8.1	
TGM-16	14.0	9.5	4.85	1.0	7.5	
TGM-25	14.0	9.5	4.85	1.0	8.1	
TGM-29	14.0	9.5	4.85	1.2	7.4	
TGM-128	14.3	9.52	4.78	1.65	8.2	

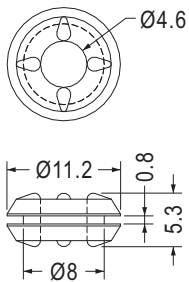

• TGM-11可配合TGM3-10和TGM632-10螺絲用

Part No.	Package
TGM-11	1000

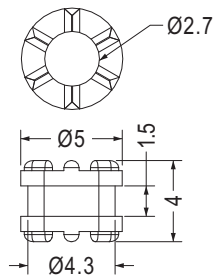

• TGM-17可配合TGM-17SW螺絲用

Part No.	Package
TGM-17	2000

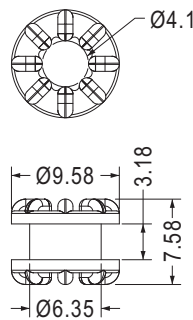

Part No.	Package
TGM-18	1000

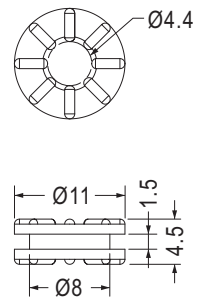

• Material: Silicon Rubber

Part No.	Package
TGM-21	1000

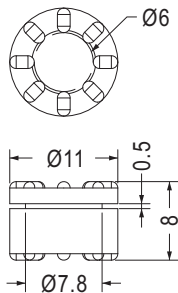

Part No.	Package
TGM-38	2000

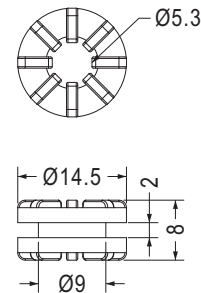

Part No.	Package
TGM-40	1000

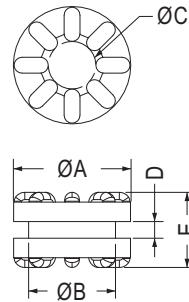

• TGM-10可配合TGM-10SW螺絲用
• TGM-13可配合TGM-13SW螺絲用

Part No.	A	B	C	D	E	Package
TGM-10	9.62	6.3	3.9	1.6	5.8	1000
TGM-13	10.5	7.8	4.75	1.5	6.75	
TGM-22	9.62	6.3	3.9	3.0	7.0	
TGM-23	11.0	7.8	4.75	1.0	8.0	
TGM-24	9.62	6.3	3.9	1.0	5.8	
TGM-28	9.62	6.3	3.9	1.2	5.8	
TGM-42	12.0	9.0	6.0	1.0	9.0	2000
TGM-52	9.62	6.35	3.9	0.8	5.8	1000
TGM-82	9.5	7.0	4.3	2.6	6.6	
TGM-129	9.0	6.0	4.0	1.3	3.7	
TGM-151	9.2	6.5	4.1	1.0	4.6	
TGM-153	7.8	6.0	4.0	1.1	4.5	
TGM-161	19.0	13.8	9.0	3.0	10.2	
TGM-162	7.0	5.5	3.9	1.0	5.8	
TGM-163	10.5	7.8	4.75	2.0	7.25	
TGM-167	8.0	5.5	3.9	0.8	3.4	

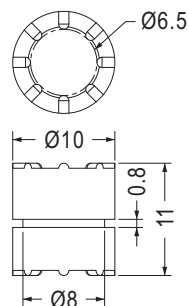

Part No.	Package
TGM-41	1000

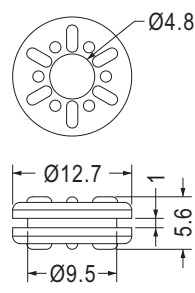

Part No.	Package
TGM-64	1000

抗震線環 ANTI-VIBRATION GROMMET

用途：用於硬碟及精密零件之防震。
G: 為45度硬度，H: 為55度硬度



- Material: TPE (UL 94V-0 is optional)
G: Hardness is Shore A45
H: Hardness is Shore A55
- Color: Black/Blue
- Unit: mm

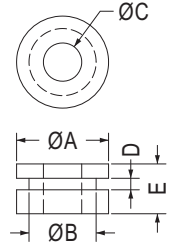
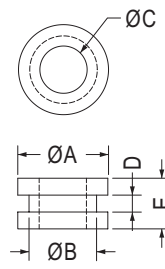

【 TGM-46, TGM-86, TGM-97 】

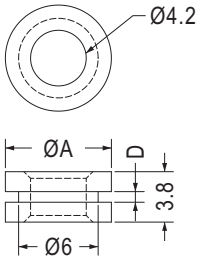

Part No.	A	D	Package
TGM-36	8.0	0.8	1000
TGM-164	8.5	1.1	

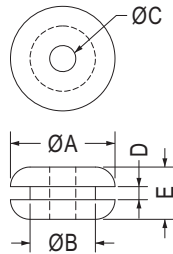

Part No.	A	B	C	D	E	Package
TGU-1	12.0	9.0	6.0	1.0	9.0	1000
TGM-20	8.0	6.0	4.2	1.5	4.6	
TGM-46	7.0	5.5	4.0	0.6	5.5	
TGM-86	9.6	7.0	4.0	1.2	5.2	
TGM-97	8.0	6.0	4.2	0.8	2.9	
TGM-116	10.0	7.0	5.0	2.0	5.0	
TGM-131	8.8	6.6	3.6	0.8	3.8	
TGM-137	8.8	6.0	4.2	0.9	2.9	
TGM-143	8.0	6.0	4.2	0.9	2.9	
TGM-145	9.6	7.6	5.6	0.8	2.8	
TGM-146	6.5	5.0	4.0	1.0	3.8	
TGM-170	7.5	5.8	3.1	0.9	2.8	
TGM-177	24.0	18.0	14.0	3.0	7.0	

Part No.	A	B	C	D	E	Package
TGM-171	8.0	5.0	2.0	1.0	4.0	2000
★TGM-180	16.0	12.0	10.0	3.0	8.0	1000
★TGM-181	31.5	25.0	18.5	1.6	8.0	250
GM-131	30.0	25.5	22.0	1.6	8.0	

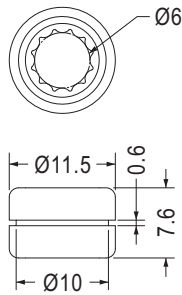
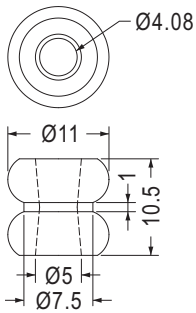
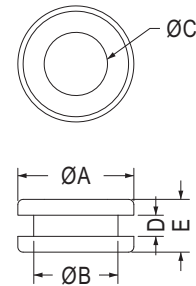

Part No.	Package
TGM-51	1000

Part No.	Package
TGM-45	1000

Part No.	A	B	C	D	E	Package
TGM-44	11.0	8.0	6.0	2.0	5.0	1000
TGM-50	7.0	5.5	3.9	0.9	2.8	
TGM-56	12.7	9.5	4.8	1.6	5.4	
TGM-81	14.2	9.5	4.9	1.0	4.9	
TGM-130	14.2	9.5	5.4	1.0	4.9	
TGM-138	8.6	7.0	5.5	0.8	7.8	
TGM-175	8.8	6.8	4.85	1.2	4.0	

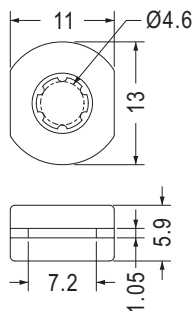
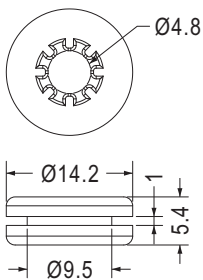

Part No.	Package
TGM-65	1000

Part No.	Package
TGM-173	1000

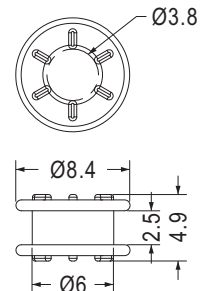
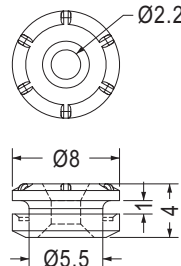

• Material: Silicon Rubber

Part No.	Package
TGM-68	1000

Part No.	Package
TGM-83	1000

抗震線環 ANTI-VIBRATION GROMMET

用途：用於硬碟及精密零件之防震。
G: 為45度硬度，H: 為55度硬度

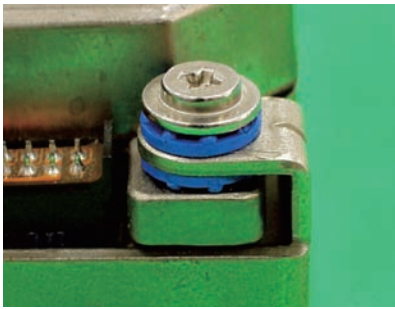

- Material: TPE (UL 94V-0 is optional)
G: Hardness is Shore A45
H: Hardness is Shore A55
- Color: Black/Blue
- Unit: mm

裝配孔尺寸，僅供參考
Mounting holes are for reference only.

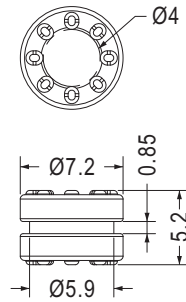

Part No.	Package
TGM-166	1000

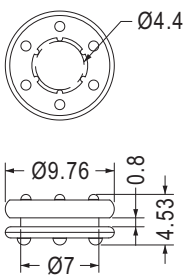

MOUNTING HOLE Ø7.0~Ø7.5

Part No.	Package
TGM-71	1000

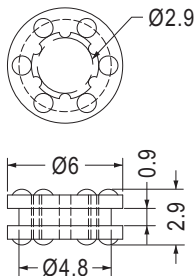

• Material: Silicon Rubber

Part No.	Package
TGM-124	1000

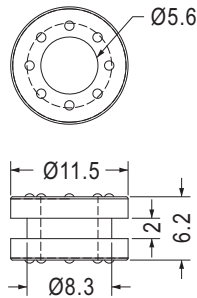

Part No.	Package
TGM-140	1000

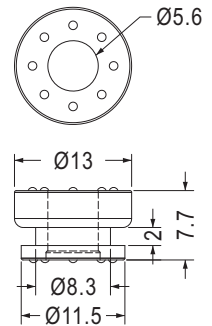

Part No.	Package
TGM-149	2000

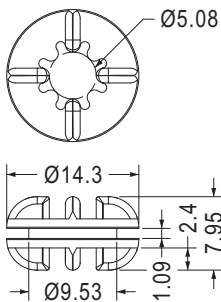

Part No.	Package
TGM-141	1000

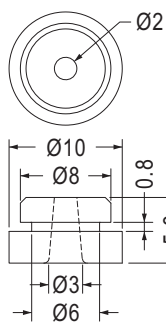

Part No.	Package
TGM-49	1000

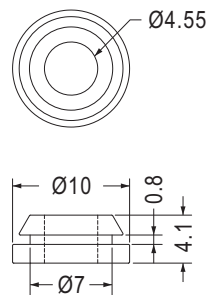

Part No.	Package
TGM-174	1000

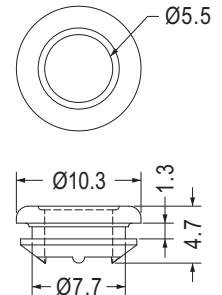

Part No.	Package
TGM-123	2000

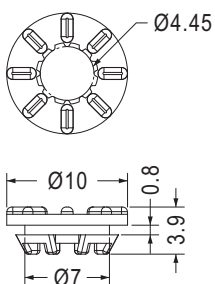

Part No.	Package
TGM-88	1000

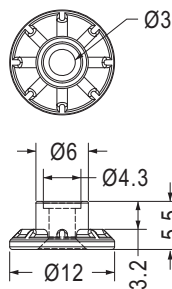

MOUNTING HOLE Ø6.0

Part No.	Package
TGM-76	1000

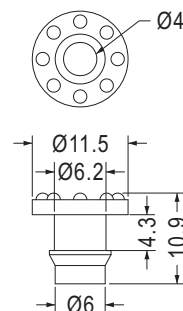

Part No.	Package
TGM-67	1000

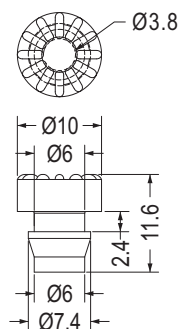

Part No.	Package
TGM-152	1000

抗震線環 ANTI-VIBRATION GROMMET

用途：用於硬碟及精密零件之防震。
G: 為45度硬度，H: 為55度硬度



裝配孔尺寸，僅供參考
Mounting holes are for reference only.

- Body Material: TPE (UL 94V-0 is optional)
G: Hardness is Shore A45
H: Hardness is Shore A55
- Pin Material: Zinc Plated Steel
- Color: Black
- Unit: mm

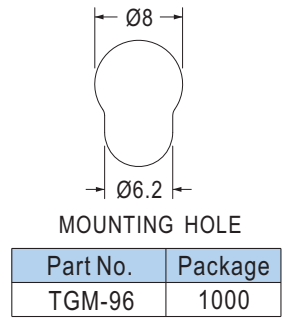
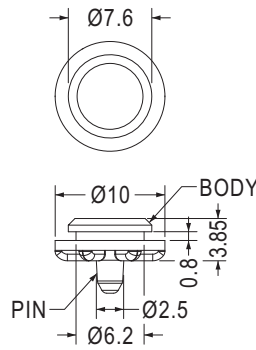

裝配孔尺寸，僅供參考
Mounting holes are for reference only.

- Body Material: TPE
- Pin Material: Zinc Plated Steel
- Color: Black/Blue
- Unit: mm

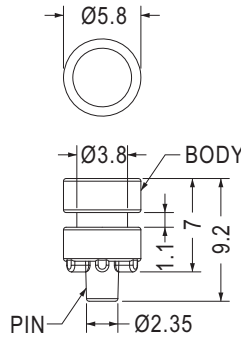

用途：用於硬碟及精密零件之防震。

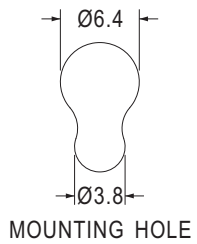

• TGM-117為專利品
• TGM-117 is patented

Part No.	Package
TGM-73	1000
TGM-117	



裝配孔尺寸，僅供參考
Mounting holes are for reference only.

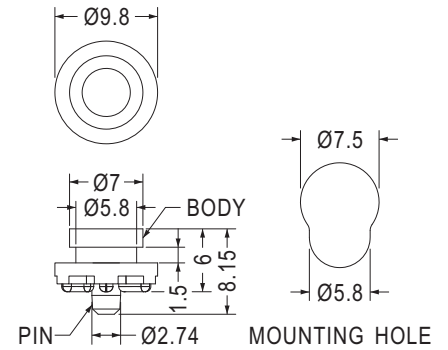
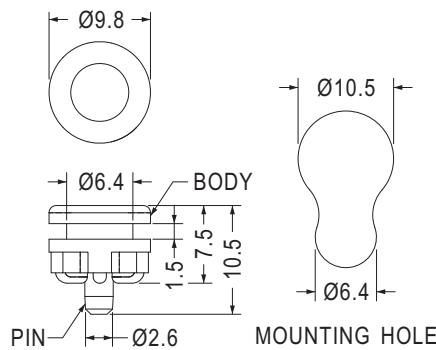

Part No.	Package
TGM-74	1000

Part No.	Package
TGM-126	1000

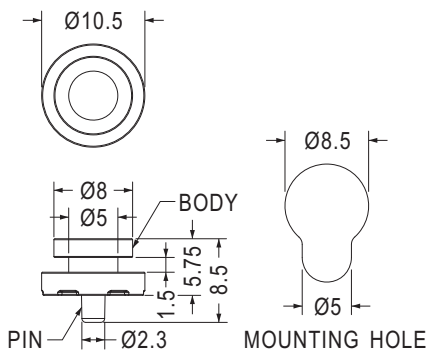

Part No.	Package
TGM-132	1000

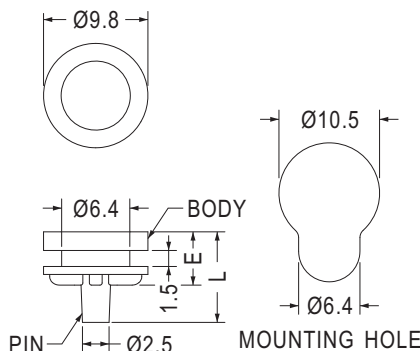

Part No.	E	L	Package
TGM-58	5.0	8.5	1000
TGM-112	5.5	9.0	

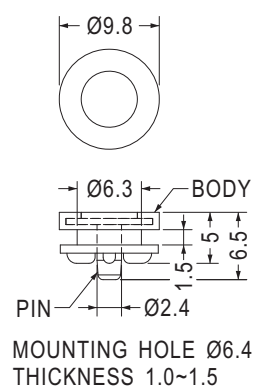

Part No.	Package
TGM-176	1000

抗震線環 ANTI-VIBRATION GROMMET

用途：用於硬碟及精密零件之防震。



裝配孔尺寸，僅供參考
Mounting holes are for reference only.

- Body Material: TPE
- Pin Material: Zinc Plated Steel
- Color: Black/Blue
- Unit: mm

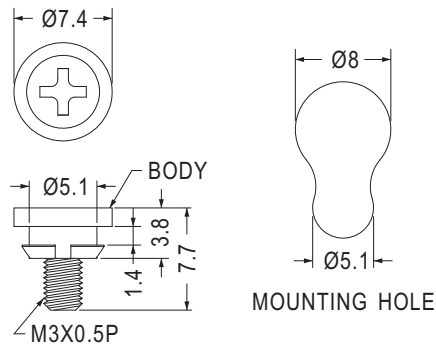

Part No.	Package
TGM-69	1000

螺絲 SCREW

用途：硬碟及精密零件之抗震線環用螺絲，可配抗震線環使用。



- Material: Steel
- Finish: Nickel Plating
- Unit: mm

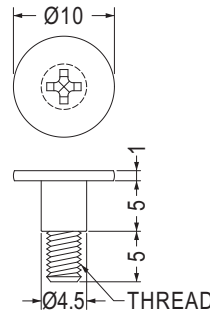

• 可配抗震線環TGM-11使用

Part No.	Thread	Package
TGM3-10	M3X0.5	1000
TGM632-10	6-32 UNC	

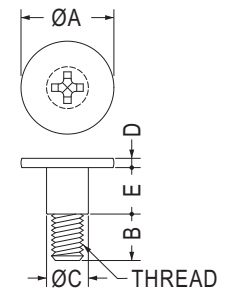
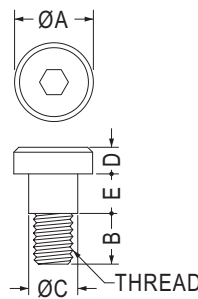
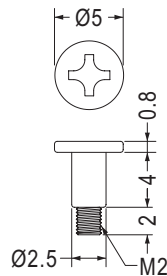
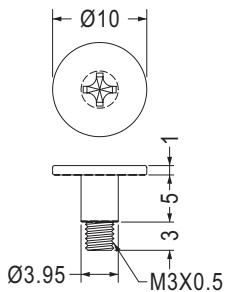

[TGM3-9.8SW]

• 可配抗震線環TGM-10使用

Part No.	Package
TGM3-8SW	1000

• 可配抗震線環TGM-17使用

Part No.	Package
TGM-17SW	1000

Part No.	A	B	C	D	E	Thread	Package
TGM3-9.8SW	10.0	3.4	4.8	1.0	6.4	M3X0.5	1000
TGM3-11SW	6.0	4.0	4.0	3.0	4.01		
TGM4-11SW	8.0	5.15	5.0	2.7	4.01	M4X0.7	
TGM4-13SW	8.0	7.25	5.0	2.7	4.01		

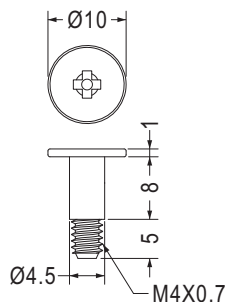

Part No.	Package
TGM4-13ST-1	1000

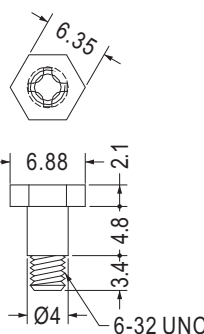

• 可配抗震線環TGM-10使用

Part No.	Package
TGM-10SW	1000

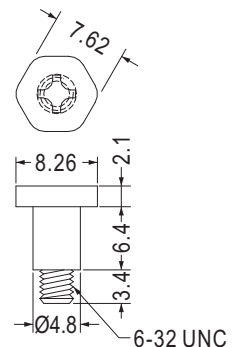

• 可配抗震線環TGM-13使用

Part No.	Package
TGM-13SW	1000

插銷 PIN



- Material: PC (UL)
- Flame Class: 94V-0
- Color: Black
- Unit: mm
- Patented (專利品)

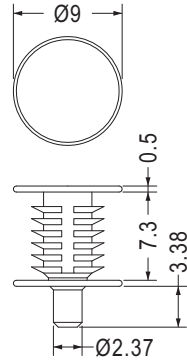

用途：硬碟及精密零件之抗震線環用插銷，可配抗震線環使用。

• 可配抗震線環TGM-128使用

Part No.	Package
TGM-128A	1000

抗震線環 ANTI-VIBRATION GROMMET



- Material: NBR/Rubber/Silicon Rubber
- Color: Black
- Unit: mm

用途：用於硬碟及精密零件之防震。

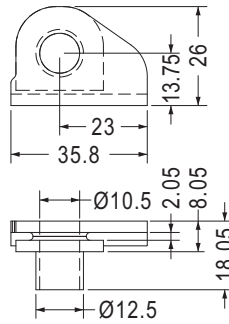

Part No.	Package
GM-25	1000

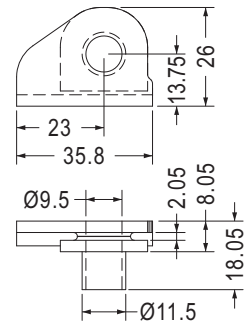

Part No.	Package
GM-26	1000

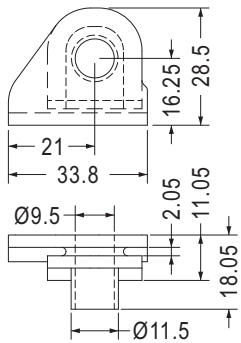

Part No.	Package
GM-27	1000

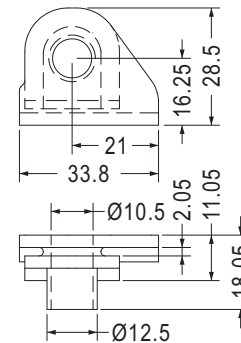

Part No.	Package
GM-28	1000

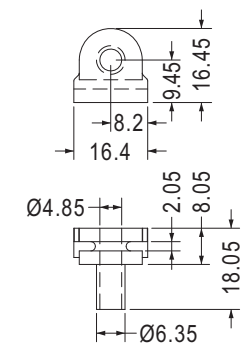

Part No.	Package
GM-31	1000

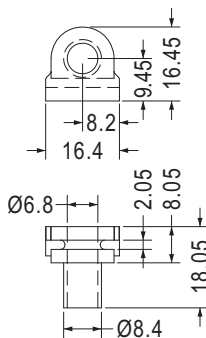

Part No.	Package
GM-32	1000

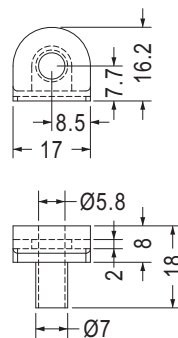

Part No.	Package
GM-33	1000

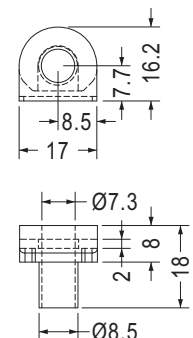

Part No.	Package
GM-34	1000

磁碟機防震座 HDD ANTI-VIBRATION BASE

用途：用於磁碟機之防震保護。



- Material: TPE
- Color: Black
- Unit: mm

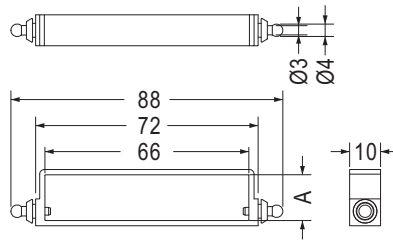

Part No.	A	HDD	Package
DKHR-1	14.8	3.5"	250
DKHR-7	6.7	2.5"	100
DKHR-9	9.3		

護線環 SNAP BUSHING

用途：用於機殼的電線出線口，保護電線不受機殼刮傷，裝配容易。



- Material: TPE
- Color: Black
- Unit: mm

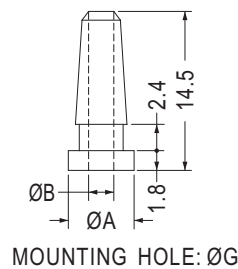

Part No.	A	B	G	Package
LGT-2	6.0	2.3	4.0	1000
LGT-6G	7.0	3.0	4.8	

5

矽膠護線環 SILICON SNAP BUSHING

用途：用於機殼的電線出線口，保護電線不受機殼刮傷，裝配容易。



- Material: Silicon Rubber
- Color: Black
- Unit: mm

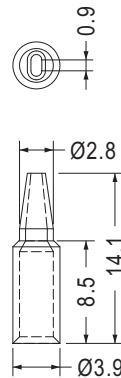

Part No.	Package
TF-395	1000

天線護線環 ANTENNA SNAP BUSHING

用途：用於天線之絕緣與保護。



- Material: Silicon Rubber
- Color: White/Black
- Unit: mm

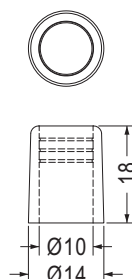

Part No.	Package
ANTCV-2	500

扣式塞頭 HOLE PLUG

用途：可將多餘的機殼出線口遮蓋，裝配容易。



- Material: TPE (UL)
- Flame Class: 94V-0
- Color: Black
- Unit: mm

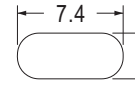
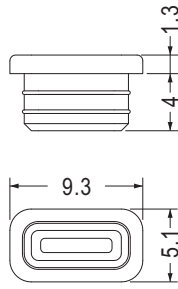

RECOMMEND MOUNTING HOLE

裝配孔尺寸，僅供參考
Mounting holes are for reference only.

Part No.	Package
MHDS-1	1000

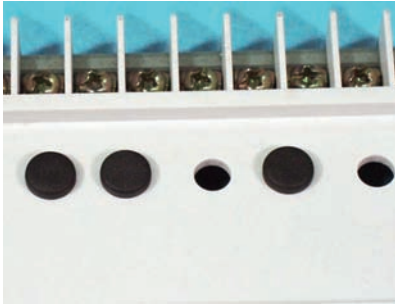

- Material: TPE/TPE (UL)
- Flame Class: 94V-0
- Color: Black
- Unit: mm

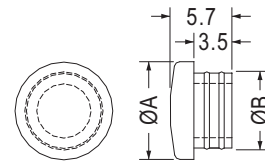

MOUNTING HOLE: ØG

裝配孔尺寸，僅供參考
Mounting holes are for reference only.

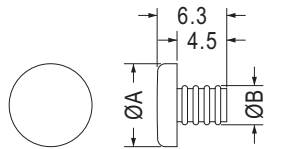

MOUNTING HOLE: ØG or M4
【 MHD-3.3 】

Part No.	A	B	G	Package
MHD-3.3	7.5	3.55	3.3	1000
MHD-4.5	6.0	4.7	4.5	
MHD-5	7.0	5.2	5.0	
MHD-5L	7.0	5.2	5.0	
MHD-5.5	7.0	5.6	5.5	
MHD-5.5I	7.0	5.6	5.5	
MHD-6	8.0	6.2	6.0	
MHD-6.5	8.0	6.9	6.5	
MHD-7	9.0	7.2	7.0	
MHD-7S	9.0	7.3	7.0	
MHD-7.5I	10.0	7.9	7.5	
MHD-8	10.0	8.2	8.0	
MHD-9	11.0	9.4	9.0	
MHD-10L	12.0	10.4	10.0	
MHD-17I	17.0	13.6	12.0	

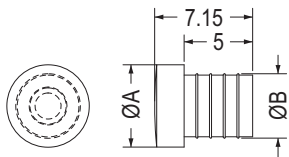

MOUNTING HOLE: ØG
【 MHD-4.5 】

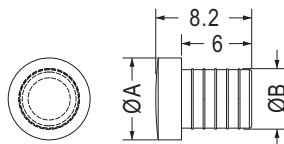

MOUNTING HOLE: ØG
【 MHD-5L 】

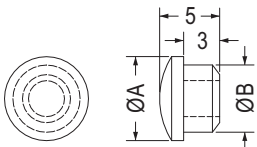

MOUNTING HOLE: ØG
【 MHD-5.5, MHD-5.5I 】

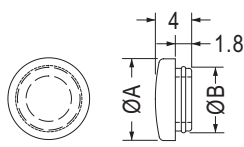

MOUNTING HOLE: ØG
【 MHD-7S 】

• Material: Silicon Rubber

• Material: Silicon Rubber

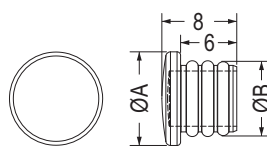

MOUNTING HOLE: ØG
【 MHD-7.5I 】

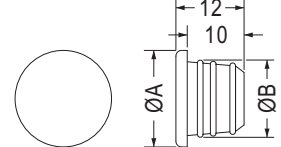

MOUNTING HOLE: ØG
【 MHD-17I 】



• Material: Silicon Rubber

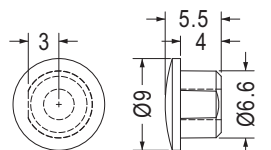

MOUNTING HOLE Ø6.35

Part No.	Package
MHD-6.3I	1000

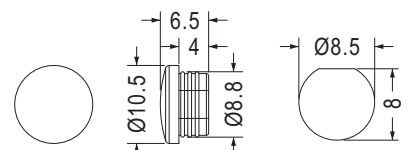

MOUNTING HOLE

Part No.	Package
MHD-16	1000

扣式塞頭 HOLE PLUG

用途：可將多餘的機殼出線口遮蓋，裝配容易。

- Material: Nylon 66 (UL)
- Flame Class: 94V-2/94V-0
- Color: Natural/Black
- Unit: mm

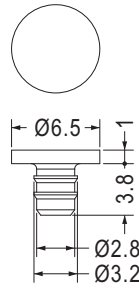

MOUNTING HOLE Ø3.0

Part No.	Package
MBH-1	1000

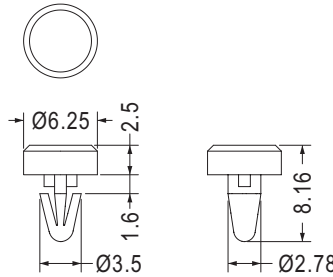

MOUNTING HOLE Ø2.8
THICKNESS 1.2

Part No.	Package
FIXE-1	1000

5

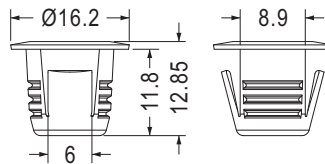

MOUNTING HOLE Ø12.0
CHASSIS THICKNESS 3.0

Part No.	Package
MHF-1	1000

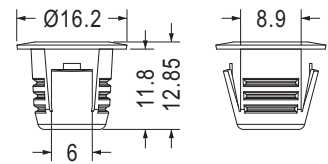

MOUNTING HOLE Ø12.0
CHASSIS THICKNESS 3.0

Part No.	Package
MHF-2	1000

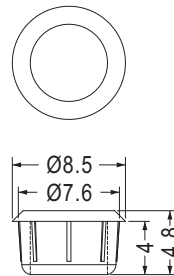

MOUNTING HOLE Ø7.5

Part No.	Package
MHC-1	1000

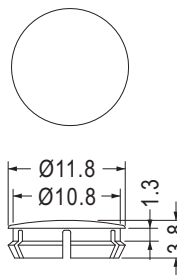

MOUNTING HOLE Ø11.0

Part No.	Package
MHE-11	1000

扣式塞頭 HOLE PLUG

用途：可將多餘的機殼出線口遮蓋，裝配容易，輕微防水。



- Material: Nylon 66 (UL)/TPU
- Flame Class: 94V-2
- Color: Black
- Unit: mm

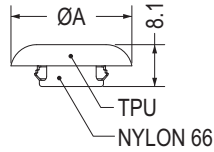
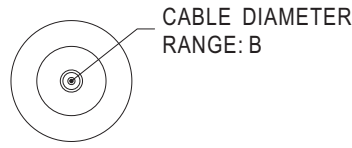

MOUNTING HOLE: ØG
THICKNESS 1.0~1.6

Part No.	A	B	G	Package
MBP-12.7	23.4	2.0~5.1	12.7	1000
MBP-15.9	26.2	3.3~9.5	15.9	
MBP-19.1	29.2	4.4~10.2	19.1	
MBP-22.2	32.5	3.3~11.4	22.2	500
MBP-25.4	36.3	5.1~18.2	25.4	
MBP-27.8	38.9	6.4~19.4	27.8	



- Material: Nylon 66 (UL)
- Flame Class: 94V-2/94V-0
- Color: Natural/Black
- Unit: mm

用途：可將多餘的機殼出線口遮蓋，裝配容易。

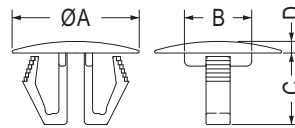

MOUNTING HOLE: ØG
THICKNESS: T

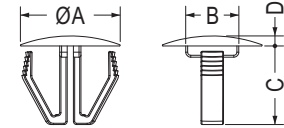

MOUNTING HOLE: ØG
THICKNESS: T

【 MBWK4-1 】

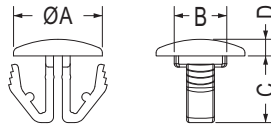

MOUNTING HOLE: ØG
THICKNESS: T

【 MBWK-8 】

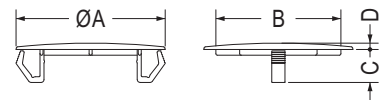

MOUNTING HOLE: ØG
THICKNESS: T

【 MBWK-7 】

Part No.	A	B	C	D	G	T	Package
MBWK-1	18.5	9.8	10.4	1.7	11.0~14.0	0.8~3.5	500
MBWK-2	30.0	15.5	11.6	1.9	22.0~26.0	0.8~3.5	
MBWK4-1	16.0	8.5	12.6	1.6	9.5~11.0	0.8~3.2	200
MBWK-7	52.0	43.6	11.5	2.2	44.7~49.0	0.8~3.2	
MBWK-8	8.0	4.7	6.0	1.5	5.0~6.0	0.8~1.6	500



- Material: POM
- Color: Black
- Unit: mm

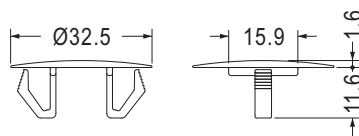

MOUNTING HOLE Ø22.0~Ø25.5
THICKNESS 0.8~3.2

Part No.	Package
MBWK-9	500

扣式塞頭 HOLE PLUG

用途：可將多餘的機殼出線口遮蓋，裝配容易。

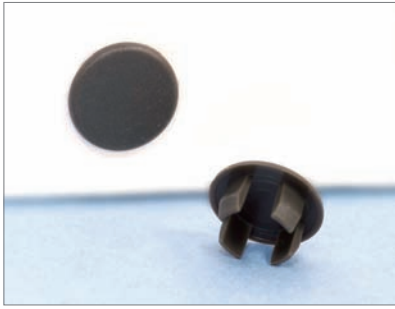

- Material: Nylon 66 (UL)
- Flame Class: 94V-2/94V-0
- Color: Natural/Black
- Unit: mm

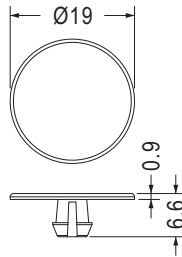

MOUNTING HOLE Ø4.75~Ø5.1
THICKNESS 3.3~3.5

Part No.	Package
MBT-14	1000

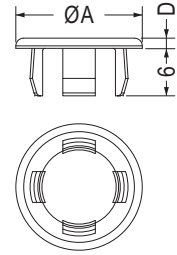

MOUNTING HOLE: ØG
THICKNESS 0.8~3.8

Part No.	A	D	G	Package
MBPP-6	10.4	1.1	6.0	1000
MBPP-6.4	10.4	1.1	6.4	
MBPP-12	16.0	1.3	12.0	



- Material: TPE
- Color: Natural/Black
- Unit: mm

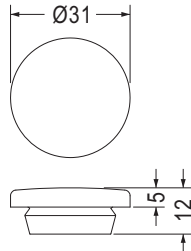

MOUNTING HOLE Ø22.0
THICKNESS 0.8~2.0

Part No.	Package
CDELT-11	500

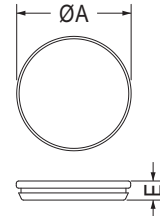

MOUNTING HOLE: ØG
THICKNESS 0.8~1.0

Part No.	A	E	G	Package
CDELT-1	24.0	4.0	22.0	1000
CDELT-4	16.0	3.5	13.0	

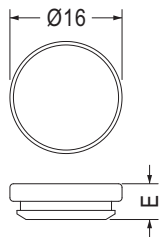

MOUNTING HOLE Ø13.0
THICKNESS: T

Part No.	E	T	Package
CDELT-6	3.5	1.0	1000
CDELT-7	5.1	1.0~1.2	

- Material: TPE (UL)
- Flame Class: 94HB

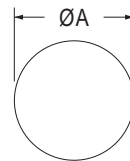

MOUNTING HOLE: ØG
THICKNESS 1.6

Part No.	A	E	G	Package
CDELT-16	38.2	7.5	31.5	200
★CDELT-17	18.7	5.6	12.7	1000



- Material: TPE (UL)
- Flame Class: 94HB
- Color: Black
- Unit: mm

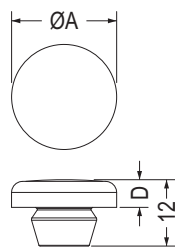

MOUNTING HOLE: ØG
THICKNESS 0.8~2.0

用途：可將多餘的機殼出線口遮蓋，裝配容易。

Part No.	A	D	G	Package
CDELT-12	19.0	5.0	10.0	500
CDELT-13	25.0	5.0	16.0	
CDELT-14	39.0	5.5	30.0	200

扣式塞頭 HOLE PLUG

用途：可將多餘的電源線扣機殼出線口遮蓋，裝配容易。



- Material: Nylon 66 (UL)
- Flame Class: 94V-2/94V-0
- Color: Natural/Black
- Unit: mm

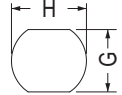
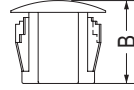
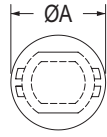

MOUNTING HOLE THICKNESS: T

Part No.	A	B	G	H	T	Package
M9.5U	12.0	10.5	7.9	9.5	0.8~3.5	1000
M11U	14.5	10.6	9.9	11.0	3.3	
M12U	16.2	10.6	11.5	12.7	0.8~3.0	500
M14U	17.8	10.6	13.4	14.3	3.3	
M16U	18.6	10.6	14.0	15.9	0.8~3.5	
M19U	22.7	10.6	16.5	19.0	0.8~3.0	
M22U	25.6	10.6	20.5	22.1	0.8~3.3	

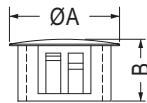
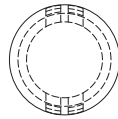

MOUNTING HOLE: ØG
THICKNESS: T

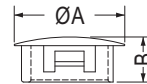
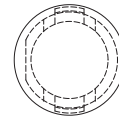

MOUNTING HOLE: ØG
THICKNESS: T

【 M13.5 】



Part No.	A	B	G	T	Package
M04	6.35	5.5	4.8	1.6	2000
M05	6.4	6.0	5.0	0.6~2.0	
M06	7.6	5.6	6.4	1.6	
M07	10.9	7.0	7.0	0.8~1.8	
M07S	8.7	6.4	7.0	1.8	1000
M08	9.5	7.6	8.0	1.6	
M09A	11.5	10.1	9.0	3.3	
M09S	13.0	5.5	9.5	1.4	
M09	11.9	10.1	9.5	3.3	500
M10	11.9	6.4	10.3	1.6	
M11	14.0	10.1	11.0	3.3	
M12	14.3	10.1	12.0	3.3	
M13	14.6	10.1	12.7	3.3	
M13.5	15.2	6.2	13.5	2.2	
M14	16.3	10.1	14.0	3.3	
M15	17.3	10.1	15.0	3.3	
M16	18.7	10.6	16.0	3.3	

Part No.	A	B	G	T	Package
M16S	20.0	7.7	15.9	2.0	1000
M17	19.3	10.1	17.0	3.3	500
M19	23.2	10.3	19.0	3.3	
M20	24.0	10.6	20.0	3.3	200
M22	25.4	11.0	22.2	3.3	
M25	28.4	11.0	25.4	3.3	
M28	32.0	13.5	28.0	3.3	
M30	34.2	11.3	30.0	3.3	
M30L	34.0	11.8	30.1	0.8~3.2	
M32	36.0	12.0	32.0	3.3	
M35	38.1	11.5	35.0	3.2	
M38	42.4	11.8	38.1	3.2	
M44	48.4	11.8	44.5	3.2	
M50	56.4	17.0	50.8	6.4	
M53	57.5	19.0	53.0	0.8~6.5	100
M63	71.2	19.1	63.5	0.8~6.4	200

扣式塞頭 HOLE PLUG

用途：可將多餘的電源線扣機殼出線口遮蓋，裝配容易。



- Material: Nylon 66 (UL)
- Flame Class: 94V-2/94V-0
- Color: Natural/Black
- Unit: mm

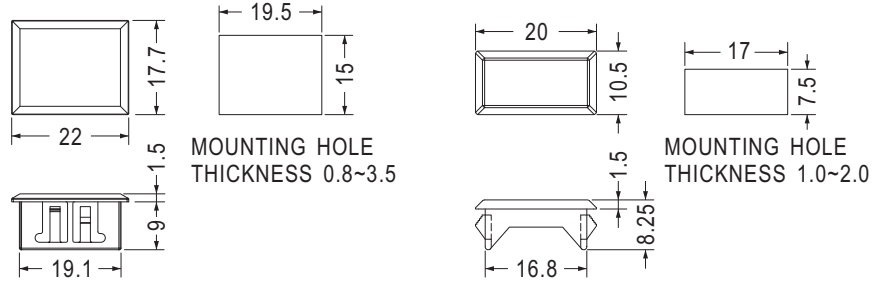

Part No.	Package
MSQ-14	500

Part No.	Package
MSQ-8	500

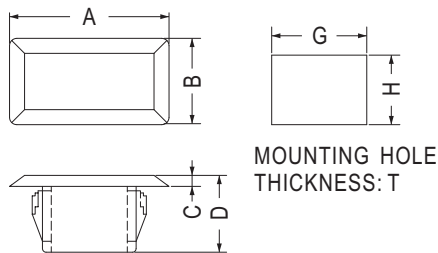

Part No.	A	B	C	D	G	H	T	Package
MSQ-1	21.8	11.8	1.5	10.5	13.0	9.5	0.8~3.5	500
MSQ-2	35.0	11.9	1.5	10.5	26.0	9.5	0.8~3.5	
MSQ-4	16.0	12.0	1.5	10.5	13.0	9.5	1.4~3.5	
MSQ-5	15.0	15.0	2.0	11.0	13.5	13.5	0.75~3.8	
MSQ-6	24.3	14.0	1.5	10.5	16.0	11.5	0.8~3.5	
MSQ-7	18.0	8.0	1.5	10.5	16.5	6.5	0.8~3.5	
MSQ-9	19.3	19.0	1.5	10.5	17.3	17.0	0.8~3.5	
MSQ-10	39.0	15.7	1.5	10.5	35.5	12.2	1.4~3.5	

塞頭 HOLE PLUG

用途：可將多餘的電源線扣機殼出線口遮蓋，裝配容易。



- Material: TPE/TPE (UL)
- Flame Class: 94HB
- Color: Black
- Unit: mm

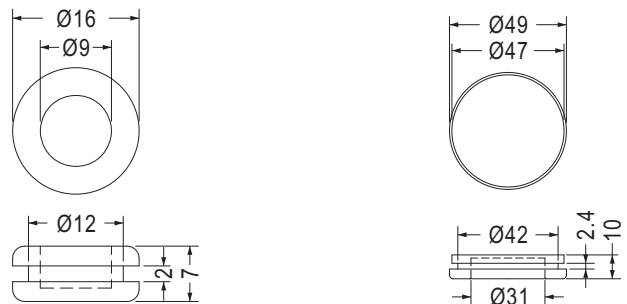

Part No.	Package
DGB-12	1000

Part No.	Package
DGB-42	100

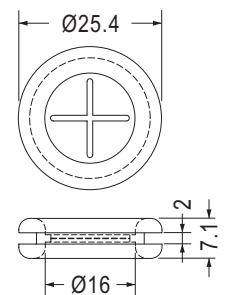
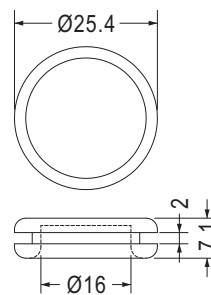
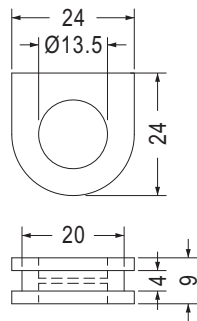
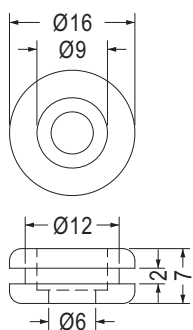

MOUNTING HOLE Ø19.0

MOUNTING HOLE Ø19.0

- Material: Rubber

- Material: Rubber

Part No.	Package
DGBD-12	1000

Part No.	Package
DGBE-1	500

Part No.	Package
DGB-19	500

Part No.	Package
DGB-19A	500

塞頭 HOLE PLUG

用途：可將多餘的電源線扣機殼出線口遮蓋，裝配容易。



裝配孔尺寸，僅供參考
Mounting holes are for reference only.

- Material: Rubber
- Color: Black
- Unit: mm

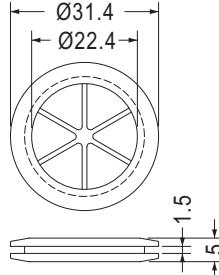

MOUNTING HOLE Ø25.4

Part No.	Package
DGB-25	500

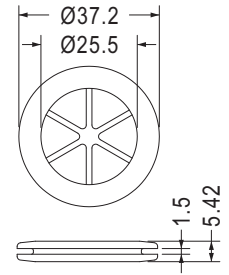

MOUNTING HOLE Ø28.5

Part No.	Package
DGB-26	500

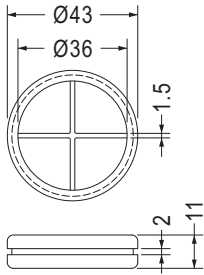

MOUNTING HOLE Ø40.0
THICKNESS 2.0

- Material: Silicon Rubber

Part No.	Package
DGB-40	200

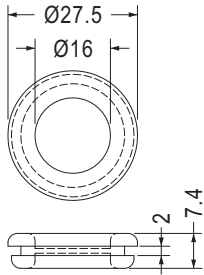

MOUNTING HOLE Ø22.0

- Material: TPE

Part No.	Package
GDBB-1	1000

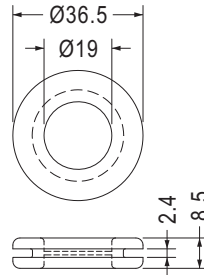

MOUNTING HOLE Ø25.5

- Material: TPE(UL)
- Flame Class: 94HB

Part No.	Package
★GDBB-2	1000

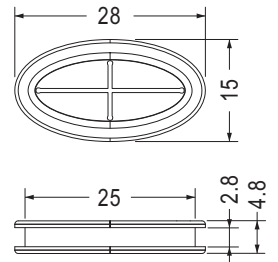

- Material: Silicon Rubber

Part No.	Package
DGDB-1	1000



裝配孔尺寸，僅供參考
Mounting holes are for reference only.

- Material: Silicon Rubber
- Color: Black
- Unit: mm

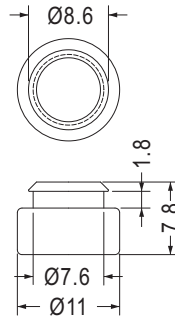

MOUNTING HOLE Ø7.0~Ø7.3
THICKNESS 1.0~1.5

Part No.	Package
TF-140	1000

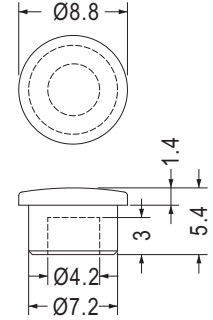

MOUNTING HOLE Ø7.0

Part No.	Package
TF-039	1000



裝配孔尺寸，僅供參考
Mounting holes are for reference only.

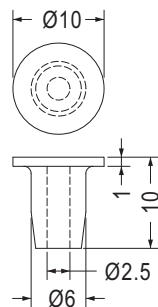

MOUNTING HOLE Ø5.5~Ø5.8

Part No.	Package
TF-618	1000

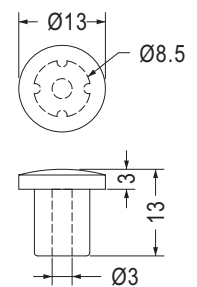

MOUNTING HOLE Ø8.3

Part No.	Package
TF-461	1000

塞頭 HOLE PLUG

用途：做為電纜線出線口之輕微防水及固定。



裝配孔尺寸，僅供參考
Mounting holes are for reference only.

- Material: EPDM
- Color: Black
- Unit: mm

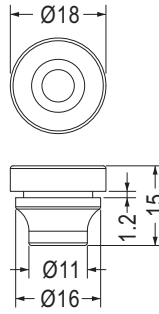

MOUNTING HOLE Ø11.5
THICKNESS 1.2~1.5

Part No.	Package
TF-1643	1000



- Material: EPDM
- Color: Black
- Unit: mm

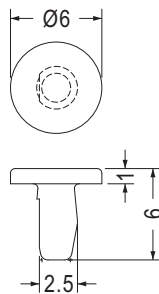

配合 M3 攻牙孔使用
FOR M3 TAPPED

Part No.	Package
TF-222	1000



裝配孔尺寸，僅供參考
Mounting holes are for reference only.

- Material: PE
- Color: Black
- Unit: mm

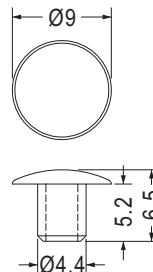

MOUNTING HOLE Ø4.0

Part No.	Package
ACSRA-4.4	1000

用途：用於水管頭之塞頭。

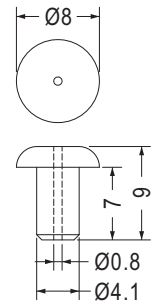

Part No.	Package
ACSRC-4.1	1000



- Material: Nylon 66 (UL)
- Flame Class: 94V-2/94V-0
- Color: Natural/Black
- Unit: mm

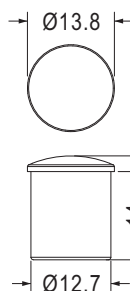

Part No.	Package
ACSRB-12.7	1000

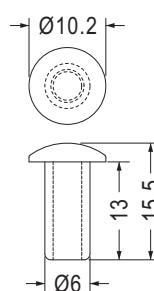

Part No.	Package
ACSRB-6	1000

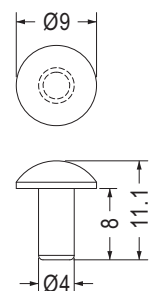

Part No.	Package
ACSRA-4	1000

扣式塞頭 HOLE PLUG

用途：可將多餘的機殼出線口遮蓋，裝配容易。



- Material: Nylon 66 (UL)
- Flame Class: 94V-2/94V-0
- Color: Natural/Black
- Unit: mm

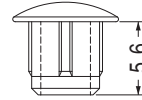
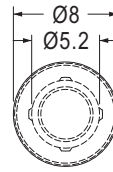

MOUNTING HOLE Ø5.5

裝配孔尺寸，僅供參考
Mounting holes are for reference only.

Part No.	Package
MHCA5.5-5.6	1000

螺絲孔塞頭 SCREW HOLE PLUG

用途：用於內六角螺絲的孔塞。



- Material: PE
- Color: Black
- Unit: mm

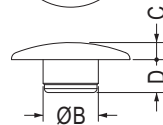
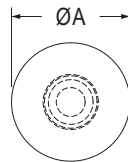

MATING SCREW: S

Part No.	A	B	C	D	S	Package
MHDA4.2-3	9.0	4.2	1.3	2.5	M5	2000
MHDA5.2-3.1	10.0	5.2	1.4	3.1	M6	

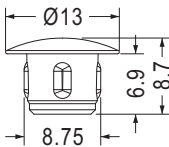
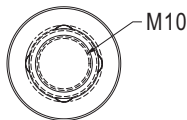

MOUNTING HOLE Ø8.5

- Material: Nylon 66 (UL)
- Flame Class: 94V-2/94V-0

Part No.	Package
MHCA8.5-6.9	1000

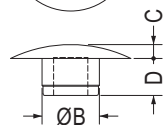
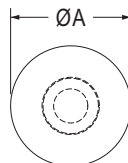

MATING SCREW: S

Part No.	A	B	C	D	S	Package
ACSRD-6.2	13.0	6.2	1.5	4.0	M8	1000
ACSRD-8.2	16.0	8.2	1.6	5.0	M10	
ACSRD-10.3	18.0	10.3	1.8	6.4	M12	

塞頭 HOLE PLUGS

用途：可將多餘的機殼出線口遮蓋，裝配容易。



- Material: Nylon 66 (UL)
- Flame Class: 94V-2/94V-0
- Color: Natural/Black
- Unit: mm

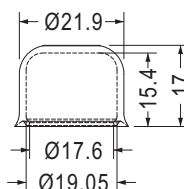

Part No.	Package
KPS-36	1000

螺紋塞頭 THREADED PROTECTION PLUG

用途：可將多餘的機殼出線口遮蓋，裝配容易。



- Material: PE
- Color: Red
- Unit: mm

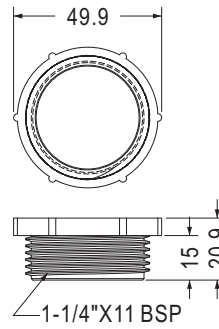

Part No.	Package
10459	250

螺絲孔塞頭 SCREW HOLE PLUG

用途：用於螺絲孔之防水及遮蔽。



- Material: Nylon 66 (UL)
- Flame Class: 94V-2/94V-0
- Color: Black
- Unit: mm

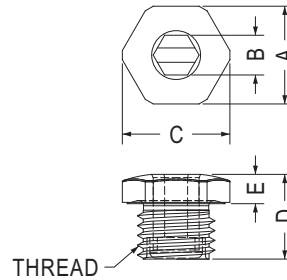

Part No.	A	B	C	D	E	Thread	Package
MOTA-12	15.0	6.1	16.5	13.0	4.5	M12X1.5P	500
MOTA-16	19.0	8.1	20.5	13.0	4.5	M16X1.5P	
MOTA-20	24.0	8.1	25.5	14.5	5.5	M20X1.5P	

- Material: POM
- Color: Black
- Unit: mm

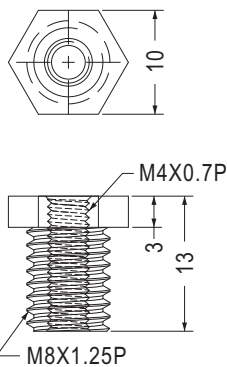

Part No.	Package
MOTB-8	500

- Material: Nylon 66 (UL)
- Flame Class: 94V-2/94V-0
- O-Ring Material: NBR
- Color: Black
- Unit: mm

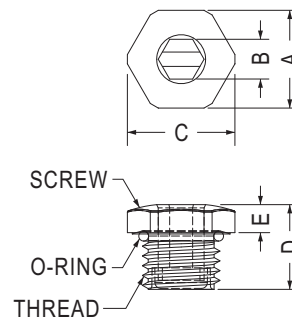

Part No.	A	B	C	D	E	Thread	Package
MOTA-12F	15.0	6.1	16.5	13.0	4.5	M12X1.5P	500
MOTA-16F	19.0	8.1	20.5	13.0	4.5	M16X1.5P	
MOTA-20F	24.0	8.1	25.5	14.5	5.5	M20X1.5P	

螺絲孔塞頭 SCREW HOLE PLUG

用途：可將多餘的機殼出線口遮蓋，具防水功能，裝配容易。



- Material: Nylon 66 (UL)
- Flame Class: 94V-2/94V-0
- Color: Black
- Unit: mm

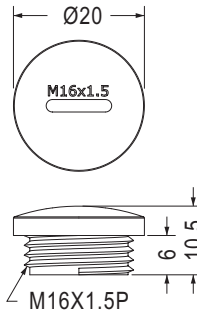

Part No.	Package
SPM-16	500

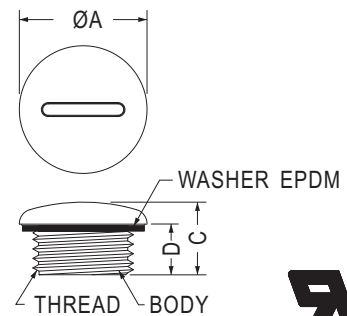
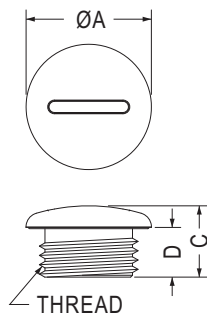

✓通過IP68防水測試

Part No.	A	C	D	Thread	Package
SPMA-10	15.0	12.5	8.5	M10X1.5	500
SPMA-12	15.0	10.0	6.0	M12X1.5	
SPMA-16	20.2	11.5	8.0	M16X1.5	
SPMA-20	24.0	12.5	7.5	M20X1.5	
SPMA-25	30.0	15.0	11.0	M25X1.5	
SPMA-32	37.0	15.7	10.8	M32X1.5	
SPMA-32S	38.0	13.8	10.0	M32X1.5	
SPMA-40	46.0	17.5	12.0	M40X1.5	

Part No.	A	C	D	Thread	Package
SPMB-10	15.0	12.0	8.5	M10X1.5	500
SPMB-12	15.0	10.0	6.0	M12X1.5	
SPMB-16	20.2	11.5	8.0	M16X1.5	
SPMB-20	24.0	12.5	7.5	M20X1.5	
SPMB-25	30.0	15.0	11.0	M25X1.5	
SPMB-32	37.0	15.7	10.8	M32X1.5	
SPMB-32S	38.8	13.8	10.0	M32X1.5	
SPMB-40	46.0	17.5	12.0	M40X1.5	

塞頭 THREADED HOLE PLUG

用途：端子的保護與防塵。



- Material: PC+ABS (UL)
- O-Ring Material: Silicon Rubber
- Flame Class: 94V-0
- Color: Black
- Unit: mm

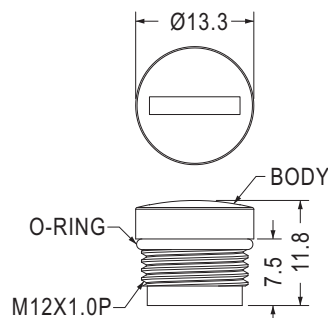

Part No.	組零件(ASSY)	Package
SPMA-12LF	SPMA-12L	500
	OR10.6-1.25I	

電源線扣 STRAIN RELIEF BUSHING

用途：用於電子電器電源出線口，固定扣牢和保護電源免於被機殼刮傷，造成短路。

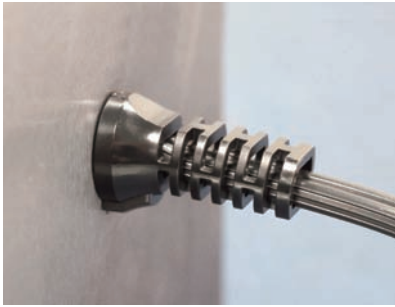

- Material: Nylon 66 (UL)
- Flame Class: 94V-2/94V-0
- Color: Black
- Unit: mm

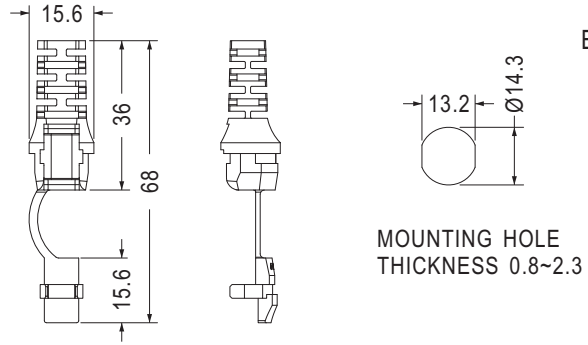

Part No.	Wires Accommodate		適用線材斷面形狀 Section Shape	Package
	UL Type Designation	Size		
SB4F-9	SPT-2	4.6X8	扁線用 Flat Type	500



- Material: Nylon 66 (UL)
- Flame Class: 94V-2/94V-0
- Color: Black
- Unit: mm

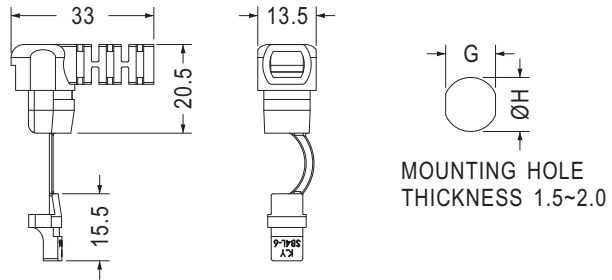

Part No.	Will Fit These Cable		Chassis Dimension		適用線材斷面形狀 Section Shape	Package
	UL Type Designation	Size	G	H		
SB4L-6	SPT-2	3.3X6.6	10.9	12.7	扁線用 Flat Type	500
		3.6X7.2		13.2		



- Material: Nylon 66 (UL)
- Flame Class: 94V-2/94V-0
- Color: Black
- Unit: mm

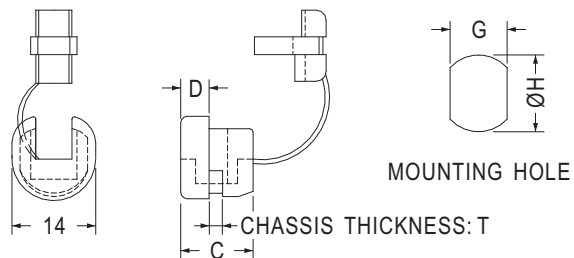

Part No.	Will Fit These Cable		Dimension		Chassis Dimension		Chassis Thickness	Package	UL
	UL/CSA Description	Size	C	D	G	H	T		
SB4F-2	SPT-2	4.1X 8.6	12.4	4.0	11.8	12.7	1.8~2.5	500	UL
SB5P-2	SJT2C#18	Ø6.8~Ø7.8	12.5	4.4	11.8	12.7	0.8~2.6		UL
SB5R-2	SJT3C#16	Ø8.2~Ø9.2	11.5	4.8	11.5	12.7	0.8~1.6		

電源線扣 STRAIN RELIEF BUSHING

用途：用於電子電器電源出線口，固定扣牢和保護電源免於被機殼刮傷，造成短路。

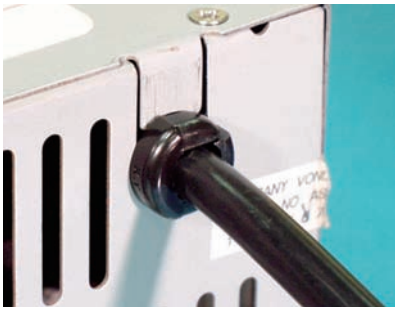

- Material: Nylon 66 (UL)
- Flame Class: 94V-2/94V-0
- Color: Black
- Unit: mm

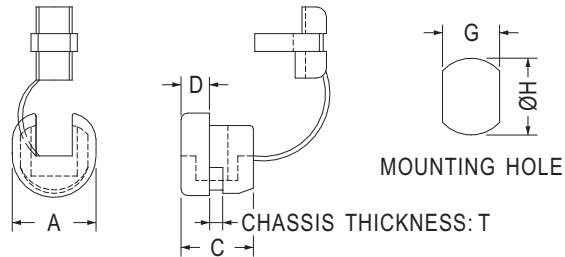

Part No.	Will Fit These Cable		Dimension			Chassis Dimension		Chassis Thickness	Package
	UL/CSA Description	Size	A	C	D	G	H	T	
SB5R-4	SJT3C#16	Ø8.2~Ø9.2	13.4	10.9	4.2	11.5	13.1	0.8~1.6	500
	SJT3C#18	Ø7.6	13.4	10.9	4.2	11.5	12.7	0.8~1.6	
SB5F-4	SPT-3	5.0 X10.0	15.5	15.4	6.2	13.4	14.3	0.8~1.6	250
SB5F-6	SPT-3	5.0 X10.0	15.5	15.4	6.2	13.4	14.3	1.8~3.2	
SB6R-6	SJT3C#16	Ø8.2~Ø9.2	16.6	14.6	5.6	14.0	15.9	0.8~1.6	



- Material: Nylon 66 (UL)
- Flame Class: 94V-2/94V-0
- Color: Black
- Unit: mm

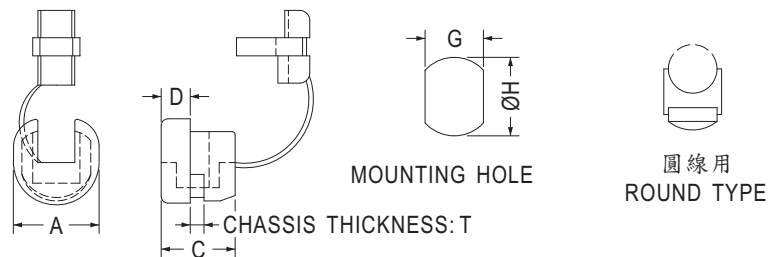

Part No.	Will Fit These Cable			Dimension			Chassis Dimension		Chassis Thickness	適用線材 斷面形狀 Section Shape	Package
	UL Type Designation	AWG Conductor	Size	A	C	D	G	H	T		
SB8R-2	SJT	14/3C	Ø13.5~Ø15.2	22.6	20.4	8.4	21.7	22.0	1.8~2.5	圓線用 Round Type	100
SB9R-2		10/3C	Ø15.2~Ø16.3	27.5	25.2	10.6	25.4	28.0	1.2~7.0		
		10/3C	Ø17.5	27.5	25.2	10.6	25.4	30.2	1.2~7.0		



- Material: Nylon 66 (UL)
- Flame Class: 94V-2/94V-0
- Color: Black
- Unit: mm

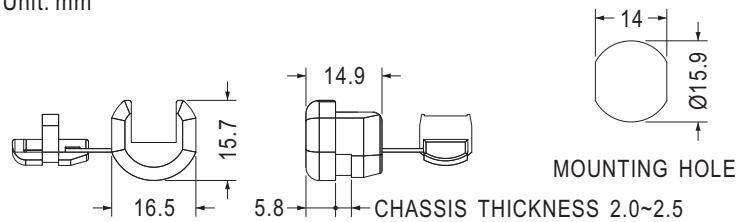

Part No.	Will Fit These Cable			Package
	UL Type Designation	AWG / Conductor	Size	
SB6P4-4	SPT-2	18/3	3.0X7.6	500
		16/3	4.1X10.4	

電源線扣 STRAIN RELIEF BUSHING

用途：用於電子電器電源出線口，固定扣牢和保護電源免於被機殼刮傷，造成短路。



- Material: Nylon 66 (UL)
- Flame Class: 94V-2/94V-0
- Color: Black
- Unit: mm

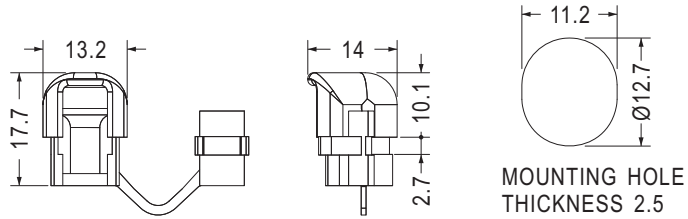

Part No.	Will Fit These Cable		Package
	UL Type Designation	Size	
SB4L-4	SPT-2	3X6.6	500
SB5L-4	SVT	6.0	

5



- Material: Nylon 66 (UL)
- Flame Class: 94V-2/94V-0
- Color: Black
- Unit: mm

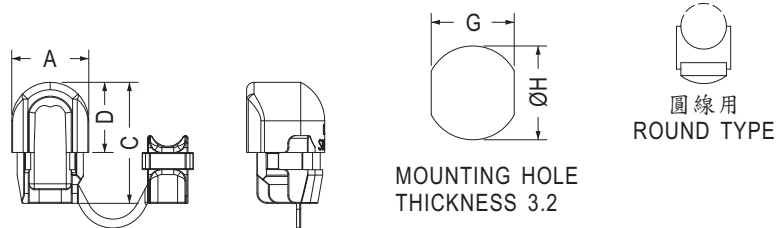

Part No.	Will Fit These Cable			Dimension			Chassis Dimension		適用線材 斷面形狀 Section Shape	Package
	UL Type Designation	AWG / Conductor	Size	A	C	D	G	H		
SB6L-6	SJT	18/3C	Ø7.4~Ø8.2	15.4	24.5	14.2	14.0	15.9	圓線用 Round Type	100
SB7L-2		14/3C	Ø9.2~Ø10.5	19.5	27.8	16.3	16.5	19.0		



- Material: Nylon 66 (UL)
- Flame Class: 94V-2/94V-0
- Color: Black
- Unit: mm

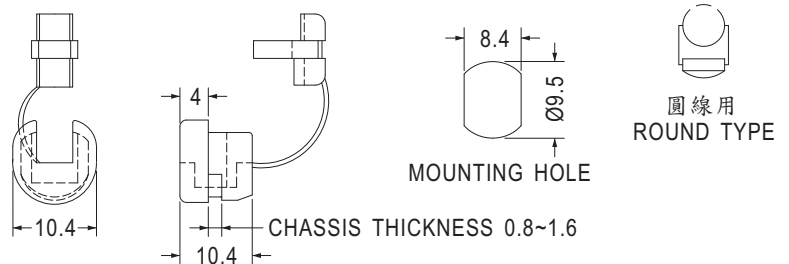

Part No.	Will Fit These Cable		適用線材斷面形狀 Section Shape	Package
	Size			
2P-1	Ø3.0~Ø4.7		圓線用 Round Type	500

電源線扣 STRAIN RELIEF BUSHING

用途：用於電子電器電源出線口，固定扣牢和保護電源免於被機殼刮傷，造成短路。



- Material: Nylon 66 (UL)
- Flame Class: 94V-2/94V-0
- Color: Black
- Unit: mm

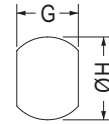
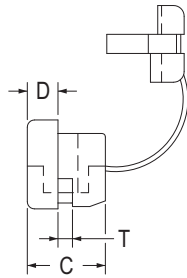
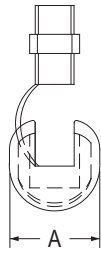

MOUNTING HOLE



圓線用
ROUND TYPE



扁線用
FLAT TYPE

Part No.	Will Fit These Cable			Dimension			Chassis Dimension		Chassis Thickness	適用線材 斷面形狀 Section Shape	Package
	UL Type Designation	AWG Conductor	Size	A	C	D	G	H	T		
2P-4	SPT-1	18/2C	3.0X5.6	10.4	10.4	4.0	8.7	9.5	1.6	扁線用 Flat Type	1000
3P-4		18/2C	3.0X5.6	11.5	10.4	4.0	9.9	11.0	1.6		
3W-1		18/2C	3.0X5.6	11.5	10.4	4.0	9.9	11.0	2.5		
4N-4	SPT-2	18/2C	3.71X7.6	13.3	10.4	4.0	11.8	12.7	1.6		
4K-4		16/2C	3.8X7.6	13.3	10.4	4.0	11.8	13.1	1.6		
		18/2C	3.71X7.6	13.3	10.5	4.0	11.8	12.7	2.5		
4K-4	16/2C	3.8X7.6	13.3	10.5	4.0	11.8	13.1	2.5			
	5N-4	SVT	18/3C	Ø6.4~Ø7.4	13.5	10.9	4.2	11.5	12.7	1.6	圓線用 Round Type
5P-4	18/3C		Ø6.4~Ø7.4	13.5	10.9	4.2	11.5	13.1	1.6		
	6N-4		18/3C	Ø6.4~Ø7.4	13.5	10.9	4.2	11.5	12.7	2.5	
6P-4			18/3C	Ø6.4~Ø7.4	13.5	10.9	4.2	11.5	13.1	2.5	
6N-4	SJT	18/3C	Ø7.6	16.8	14.8	5.6	14.0	15.9	1.6		
6P-4		18/3C	Ø7.6	16.8	14.8	5.6	14.0	15.9	3.2		
6N3-4		16/3C	Ø8.2~Ø9.2	16.2	15.0	5.6	14.0	15.9	1.6		
		16/3C	Ø8.2~Ø9.2	16.2	14.8	5.7	14.0	15.9	3.2		
7N-2		14/3C	Ø9.2~Ø10.5	19.5	19.1	7.8	16.5	19.0	1.6		
		14/3C	Ø11.0	19.5	19.1	7.8	16.5	19.8	1.6		
7P-2		14/3C	Ø9.2~Ø10.5	19.5	19.4	7.8	16.5	19.0	3.2		
		14/3C	Ø11.0	19.5	19.4	7.8	16.5	19.8	3.2		

5



- Material: Nylon 66 (UL)
- Flame Class: 94V-2/94V-0
- Color: Black
- Unit: mm

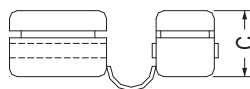
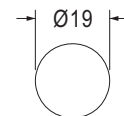
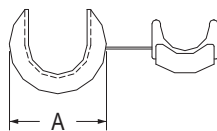

MOUNTING HOLE
THICKNESS 0.8~1.6

Part No.	Will Fit These Cable		Dimension		Package	UL
	UL/CSA Description	Size	A	C		
SB7R-7	SJT3C#10	14.0~17.0	25.0	17.0	100	UL
SB7R-7SP		12.0~15.2	25.3	17.8		

方形線扣 SQUARE STRAIN RELIEF BUSHING

用途：用於電子電器電源出線口，固定扣牢和保護電源免於被機殼刮傷，造成短路。



- Material: Nylon 66 (UL)
- Flame Class: 94V-2/94V-0
- Color: Black
- Unit: mm

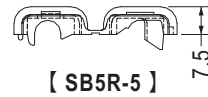
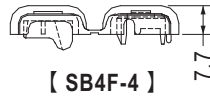
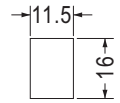
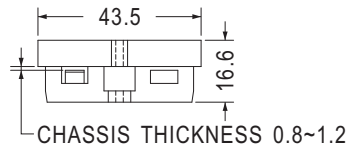
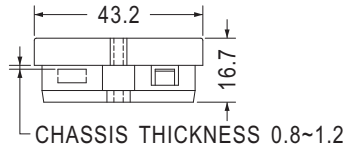

MOUNTING HOLE

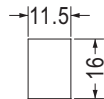
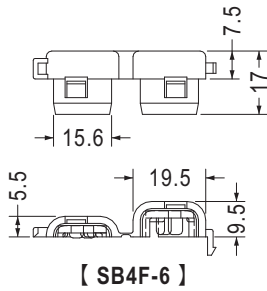

MOUNTING HOLE THICKNESS 0.8~1.2

【 SB4F-6 】

Part No.	Will Fit These Cable		Package
	UL/CSA Description	Size	
SB4F-4	SPT-1, SPT-2	3X5.6, 3.71X7.6	250
SB5R-5	SVT3C#18	Ø6.6~Ø7.2	
SB4F-6	SPT-1, SPT-2	3X5.6, 3.71X7.6	200

5

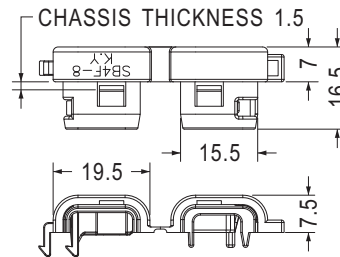

MOUNTING HOLE

Part No.	Will Fit These Cable		Package
	UL/CSA Description	Size	
SB4F-8	SPT-1, SPT-2	3X5.6, 3.71X7.6	200

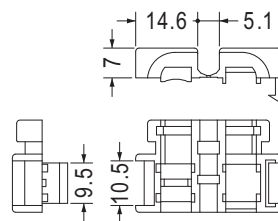

扣合前

Part No.	Package
SBU4-4	1000

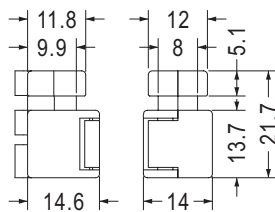

扣合後

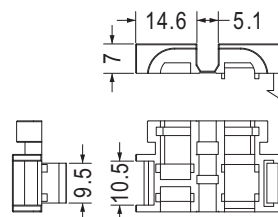

扣合前

Part No.	Package
SBU4-4-1	1000

電線線扣 STARAIN RELIEF BUSHING

用途：用於電子電器電源出線口，固定扣牢和保護電源免於被機殼刮傷，造成短路。



- Material: Nylon 66 (UL)
- Flame Class: 94V-2/94V-0
- Color: Black
- Unit: mm

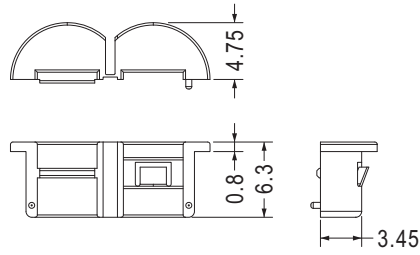

MOUNTING HOLE $\varnothing 7.0$
THICKNESS 0.6~1.1

Part No.	Package
SBU-1	2000

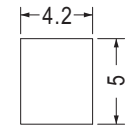
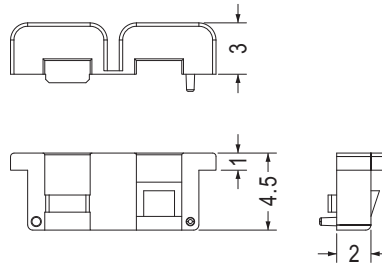
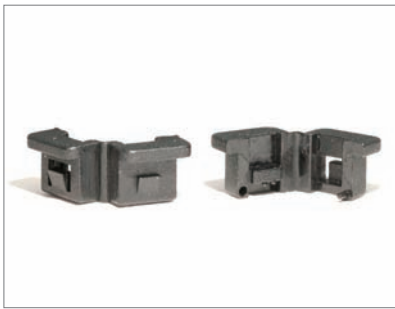

MOUNTING HOLE
THICKNESS 0.8~1.0

Part No.	Package
SBU-2	2000

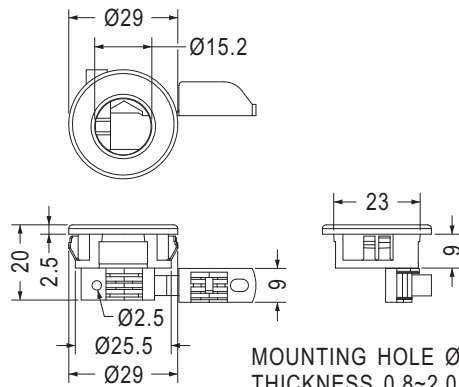

MOUNTING HOLE $\varnothing 26.0$
THICKNESS 0.8~2.0

Part No.	Package
SBB-1	200



- Material: Nylon 66 (UL)
- Flame Class: 94V-2/94V-0
- Color: Natural/Black/Gray
- Unit: mm

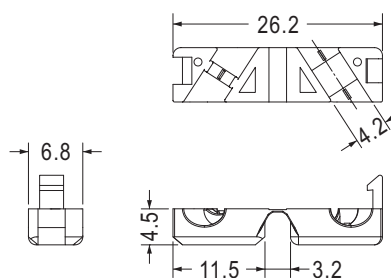

Part No.	Package
SBQC-1	100

電線固定夾 WIRE CLIP

用途：用於機殼的電線出線口，避免電源線被拉出。

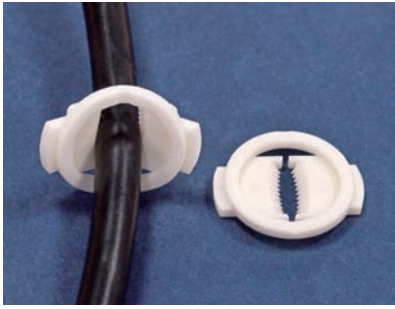

- Material: Nylon 66 (UL)
- Flame Class: 94V-2/94V-0
- Color: Natural/Black
- Unit: mm

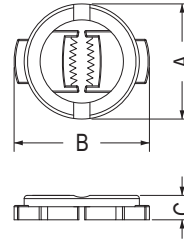

Part No.	A	B	C	Suggested Cable Diameter Range	Package
SBCR-7	17.7	20.8	3.75	Ø7.0	1000
SBCR-9	22.2	25.5	4.0	Ø9.0	

電纜固定頭 CABLE GLAND

用途：電纜防水接頭。

✓通過IP68防水測試

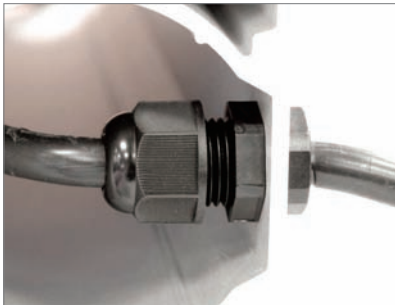

- Material: A,C,E=Nylon 66 (UL)
B,D=EPDM
- Flame Class: 94V-2/94V-0
- Color: Black
- Unit: mm

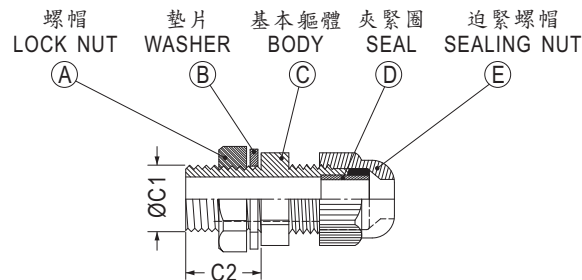

Part No.	標準螺牙 Threaded Entry Metric	適用電纜 Cable Range	螺紋外徑 Threaded O. D. C1	螺紋長度 Threaded Length C2	機板口徑 Panel Mounting Hole	扳手徑 Spanner Size A & E	Package	UL	
KGB12-07	M12X1.5P	Ø6.8~Ø4.0	Ø11.8	15.0	Ø12.0~Ø12.3	18/15	100	UL	
KGB12-07-ST		Ø6.8~Ø4.0	Ø11.8	8.5	Ø12.0~Ø12.3	18/15		UL	
KGB12-08		Ø8.5~Ø4.5	Ø11.8	8.5	Ø12.0~Ø12.3	18/15		UL	
KGB16S-8.5-ST	M16X1.5P	Ø8.5~Ø5.0	Ø15.8	10.0	Ø16.0~Ø16.3	22/22		50	UL
KGB16-10		Ø10.4~Ø6.4	Ø15.8	15.0	Ø16.0~Ø16.3	22/22			UL
KGB16-10-ST		Ø10.4~Ø6.4	Ø15.8	10.0	Ø16.0~Ø16.3	22/22			UL
KGB20-14	M20X1.5P	Ø14.0~Ø8.5	Ø19.8	15.0	Ø20.0~Ø20.3	27/27	200	UL	
KGB20-14-ST		Ø14.0~Ø8.5	Ø19.8	10.0	Ø20.0~Ø20.3	27/27		UL	
KGB25-16	M25X1.5P	Ø16.0~Ø12.0	Ø24.9	15.0	Ø25.0~Ø25.4	33/33		100	UL
KGB25-16-ST		Ø16.0~Ø12.0	Ø24.9	10.0	Ø25.0~Ø25.4	33/33			UL
KGB32-25	M32X1.5P	Ø25.0~Ø18.0	Ø32.0	15.5	Ø32.0~Ø32.4	41/42			UL
KGB32-25-ST		Ø25.0~Ø18.0	Ø32.0	10.5	Ø32.0~Ø32.4	41/42		UL	
KPGB7-5	PG7	Ø5.5~Ø3.0	Ø12.3	8.0	Ø12.5~Ø12.8	17/15	100	UL	
KPGB7-5-1		Ø5.5~Ø3.0	Ø12.3	8.0	Ø12.5~Ø12.8	17/15		UL	
KPGB9-9	PG9	Ø8.0~Ø4.5	Ø15.1	8.5	Ø15.2~Ø15.5	22/19		UL	
KPGB11-7	PG11	Ø7.0~Ø4.0	Ø18.4	10.0	Ø18.6~Ø18.9	24/22	UL		
KPGB13.5-8	PG13.5	Ø9.0~Ø5.0	Ø20.2	10.0	Ø20.4~Ø20.7	27/24	UL		

透氣壓力平衡固定頭 PRESSURE BALANCE GLAND



- Material: A=Nylon 66 (UL)
B=EPDM
C,D=PC (UL)
- Flame Class: 94V-2/94V-0
- Color: Natural/Black
- Unit: mm

用途：用於機器透氣和防水。

✓通過IP68防水測試

✓典型透氣量1.11ml/分鐘 (壓差20mbar)



防水透氣布
測試影片

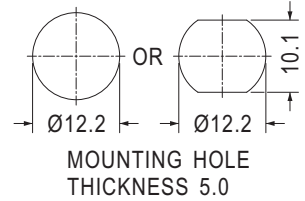
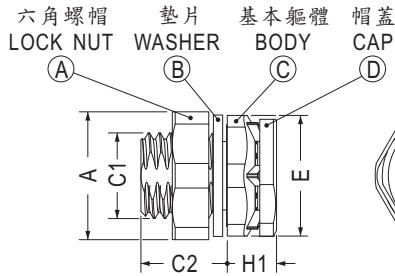

Part No.	標準螺牙 Threaded Entry Metric C1	螺紋長度 Threaded Length C2	高度 Height H1	板手徑 Spanner Size A & E	Package
MOR12-12	M12X1.5P	12.0	7.0	18/17	500

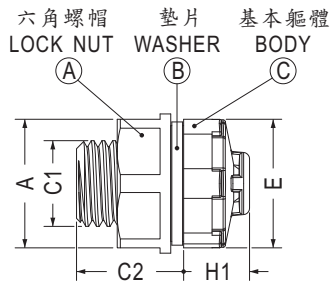

Part No.	標準螺牙 Threaded Entry Metric C1	螺紋長度 Threaded Length C2	高度 Height H1	板手徑 Spanner Size A & E	Package
MOR8-10	M8X1.0P	10.0	6.15	12/12	500

透氣壓力平衡固定扣 PRESSURE BALANCE FASTENER



- Material: A,B=PC (UL)
C=Silicon Rubber
- Flame Class: 94V-0
- Color: Black
- Unit: mm

用途：用於機器透氣和防水。

✓通過IP68防水測試

✓典型透氣量1.11ml/分鐘 (壓差20mbar)

裝配孔尺寸，僅供參考
Mounting holes are for reference only.



防水透氣布
測試影片

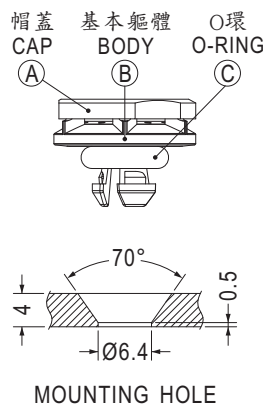
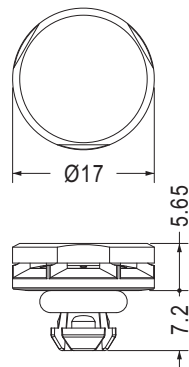

Part No.	Package
MOR-6.4	500

方型護線環 SQUARE SNAP BUSHING

用途：用於鐵板間電線出入刮傷之保護，不易脫落，使用方便，不佔空間之優點。



裝配孔尺寸，僅供參考
Mounting holes are for reference only.

- Material: Nylon 66 (UL)
- Flame Class: 94V-2/94V-0
- Color: Natural/Black
- Unit: mm

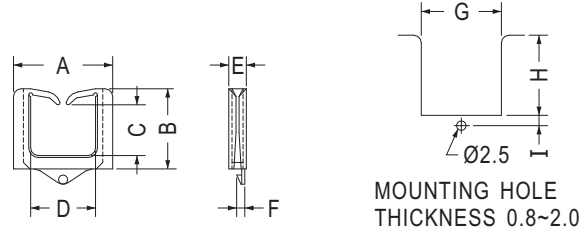

Part No.	A	B	C	D	E	F	G	H	I	Package
SQE-1	19.8	12.1	7.3	11.5	4.5	2.3	14.0	12.3	2.8	1000
SQE-2	26.0	21.0	14.0	17.0	4.6	2.3	21.0	21.0	2.7	500
SQE-2-1	26.0	21.0	14.0	17.0	4.6	1.87	21.0	21.0	2.7	
SQE-3	33.2	28.8	22.4	22.7	4.5	2.3	27.0	29.0	2.8	

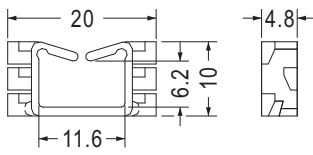

MOUNTING HOLE THICKNESS: T

Part No.	T	Package
SQF-1	0.8~1.2	500
SQF-7	1.9~2.0	

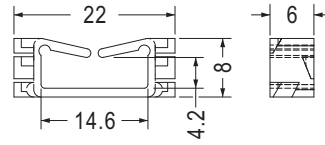

MOUNTING HOLE THICKNESS 1.2~2.8

Part No.	Package
SQF-2	500

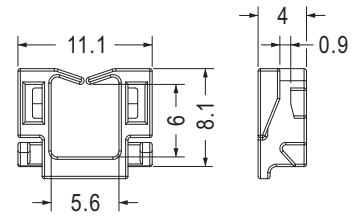

MOUNTING HOLE THICKNESS 1.2

Part No.	Package
SQF-4	500



裝配孔尺寸，僅供參考
Mounting holes are for reference only.

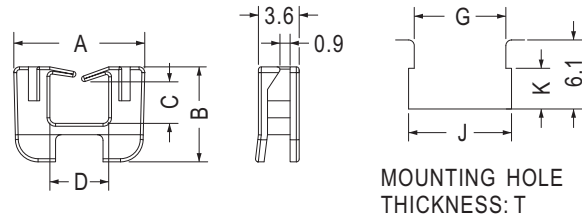

Part No.	A	B	C	D	G	J	K	T	Package
SQF-5	11.6	8.4	3.7	5.2	8.1	9.1	3.6	0.8~1.8	500
SQF-6	16.9	9.1	3.4	10.2	12.8	13.8	3.4	0.9~2.0	
SQF-8	16.9	9.0	3.2	10.2	13.0	14.0	3.4	0.9~2.0	



裝配孔尺寸，僅供參考
Mounting holes are for reference only.

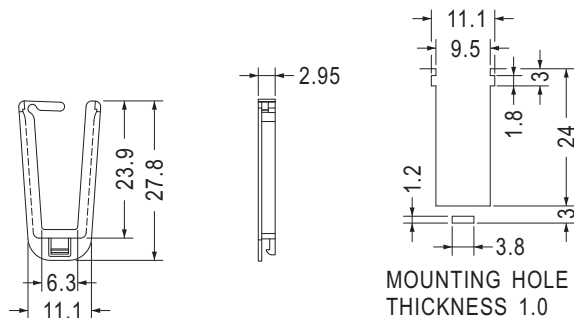

MOUNTING HOLE THICKNESS 1.0

Part No.	Package
SQE-5	500

方型護線環 SQUARE SNAP BUSHING

用途：用於鐵板間電線出入刮傷之保護，不易脫落，使用方便，不佔空間之優點。

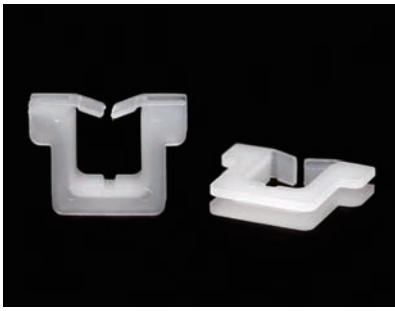

- Material: Nylon 66 (UL)
- Flame Class: 94V-2/94V-0
- Color: Natural/Black
- Unit: mm

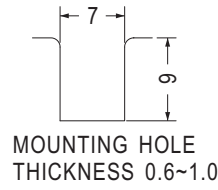
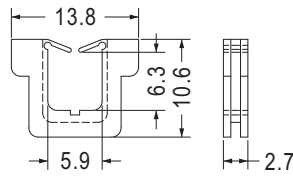

Part No.	Package
SQK-1	1000

裝配孔尺寸，僅供參考
Mounting holes are for reference only.

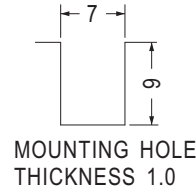
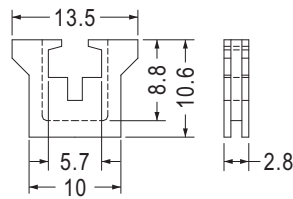

Part No.	Package
SQD-1	1000

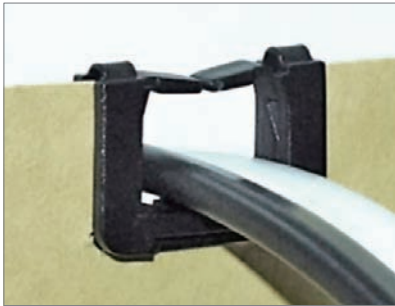

- Material: Nylon 66 (UL)
- Flame Class: 94V-2/94V-0
- Color: Natural/Black
- Unit: mm

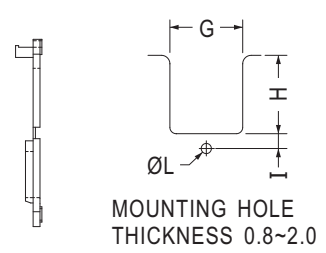
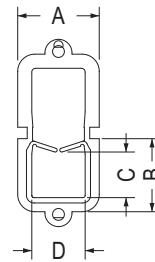

裝配孔尺寸，僅供參考
Mounting holes are for reference only.

Part No.	A	B	C	D	G	H	I	L	Package
SQB-1	18.4	14.5	8.9	11.0	14.0	12.3	2.7	2.7	500
SQB-2	21.5	18.8	11.9	13.9	17.2	18.5	3.5	3.0	

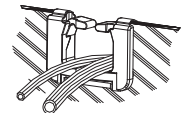
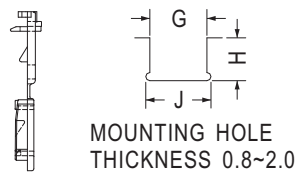
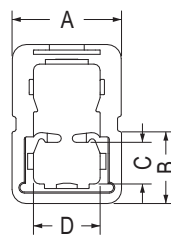
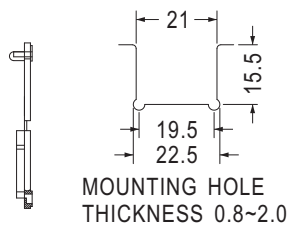
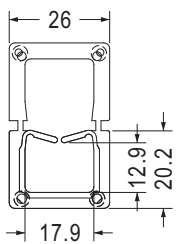

UNIT FOLDED VIEW

Part No.	Package
SQB-3	500

Part No.	A	B	C	D	G	H	J	Package
SQB-4	22.0	14.2	9.0	14.0	17.0	13.5	19.0	500
SQB-5	17.9	11.8	6.8	10.9	14.0	10.5	16.0	1000

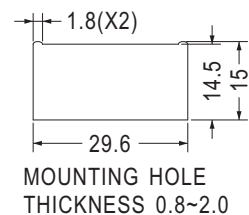
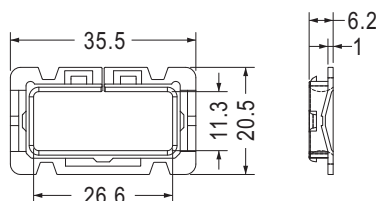

裝配孔尺寸，僅供參考
Mounting holes are for reference only.

Part No.	Package
SQL-1	500

方型護線環 SQUARE SNAP BUSHING

用途：用於鐵板間電線出入刮傷之保護，不易脫落，使用方便，不佔空間之優點。



- Material: Nylon 66 (UL)
- Flame Class: 94V-2/94V-0
- Color: Natural/Black
- Unit: mm

裝配孔尺寸，僅供參考
Mounting holes are for reference only.

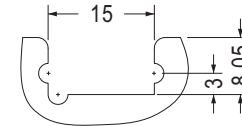
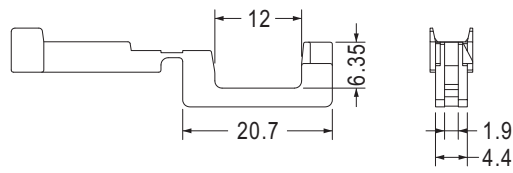

MOUNTING HOLE THICKNESS 1.5

Part No.	Package
SQJ-3	1000

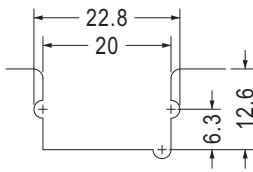
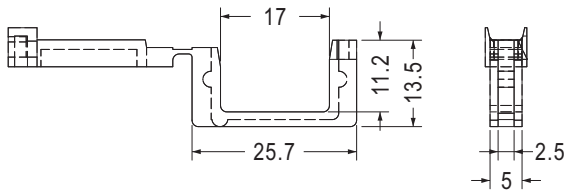

MOUNTING HOLE THICKNESS 2.1

Part No.	Package
SQJ-1	1000

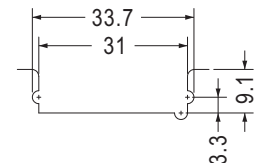
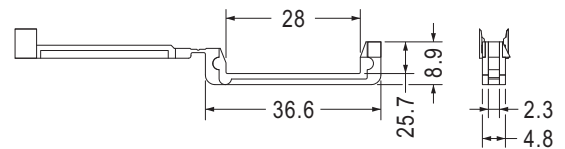

MOUNTING HOLE THICKNESS 2.0

Part No.	Package
SQJ-2	1000

5

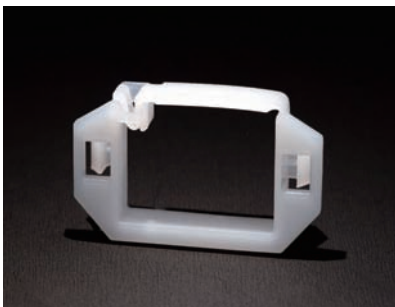

裝配孔尺寸，僅供參考
Mounting holes are for reference only.

- Material: Nylon 66 (UL)
- Flame Class: 94V-2/94V-0
- Color: Natural/Black
- Unit: mm

PANEL MOUNTING DETAILS

THROUGH HOLE INSTALLATION

EDGE INSTALLATION

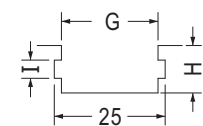
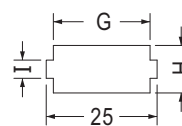

THICKNESS 0.8~1.6

【SQJA-1】

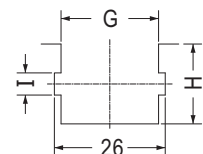
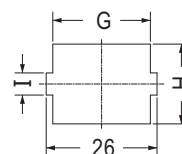

THICKNESS 2.0

【SQJA-2】

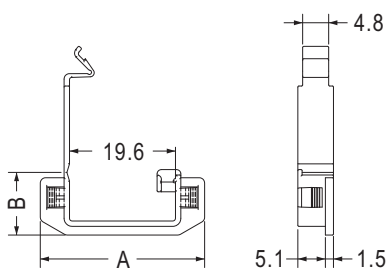

Part No.	A	B	G	H	I	Package
SQJA-1	30.4	11.6	21.8	10.7	4.1	500
SQJA-2	31.0	18.6	22.0	18.0	5.0	

方型護線環 SQUARE SNAP BUSHING

用途：用於鐵板間電線出入刮傷之保護，不易脫落，使用方便，不佔空間之優點。



- Material: Nylon 66 (UL)
- Flame Class: 94V-2/94V-0
- Color: Natural/Black
- Unit: mm

裝配孔尺寸，僅供參考
Mounting holes are for reference only.

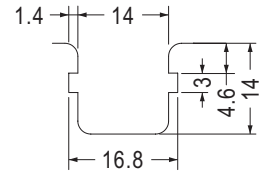
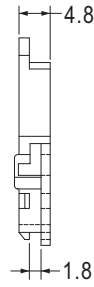
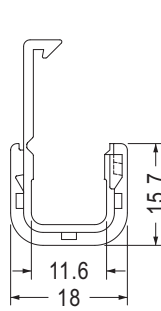

MOUNTING HOLE THICKNESS 0.8~1.8

Part No.	Package
SQI-1	1000

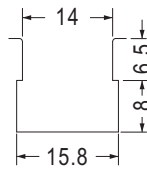
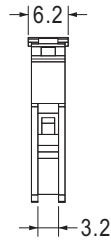
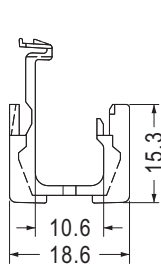

MOUNTING HOLE THICKNESS 0.8~3.0

Part No.	Package
SQA-1	1000

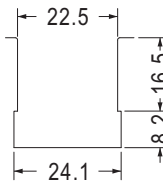
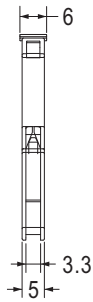
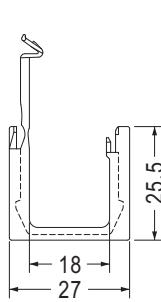

MOUNTING HOLE THICKNESS 0.8~3.0

Part No.	Package
SQA-2	1000

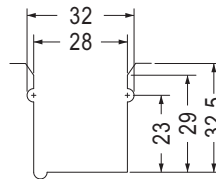
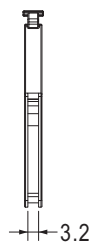
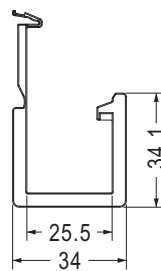

MOUNTING HOLE THICKNESS 3.0

Part No.	Package
SQA-3	1000

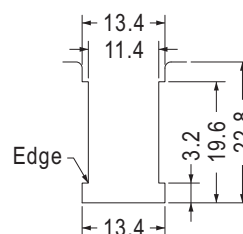
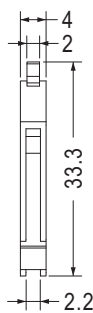
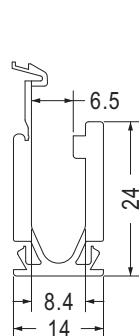

MOUNTING HOLE THICKNESS 2.0

Part No.	Package
SQR-1	500

方型護線環 SQUARE SNAP BUSHING

用途：用於鐵板間電線出入刮傷之保護，不易脫落，使用方便，不佔空間之優點。



- Material: Nylon 66 (UL)
- Flame Class: 94V-2/94V-0
- Color: Natural/Black
- Unit: mm

裝配孔尺寸，僅供參考
Mounting holes are for reference only.

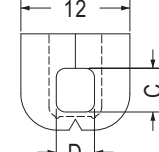
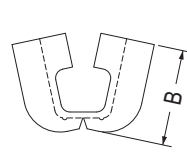
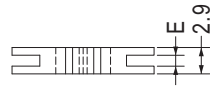

CLOSE PART

MOUNTING HOLE THICKNESS 0.8~1.0

Part No.	B	C	D	E	Package
SQG-1	10.6	4.8	4.2	1.2	1000
SQG-3	10.9	4.5	2.3	1.1	
SQG-4	10.7	4.6	4.6	1.1	
SQG-6	10.9	6.8	2.3	1.2	

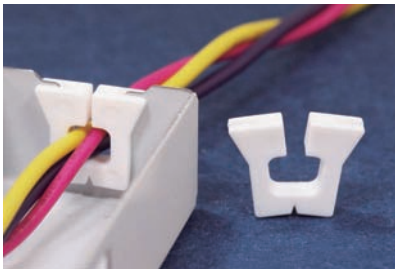

裝配孔尺寸，僅供參考
Mounting holes are for reference only.

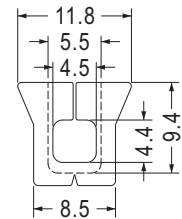
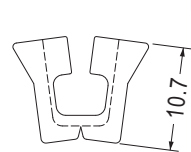

CLOSE PART

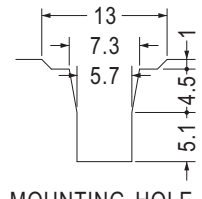

MOUNTING HOLE THICKNESS 0.5~0.8

Part No.	Package
SQG-15	1000



裝配孔尺寸，僅供參考
Mounting holes are for reference only.

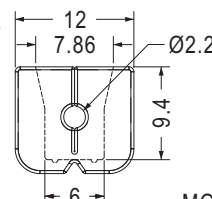
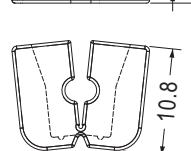

CLOSE PART

MOUNTING HOLE CHASSIS THICKNESS 0.6

Part No.	Package
SQG-9	1000



裝配孔尺寸，僅供參考
Mounting holes are for reference only.

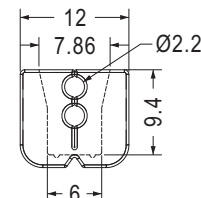
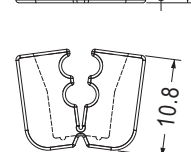

CLOSE PART

MOUNTING HOLE THICKNESS 0.6

Part No.	Package
SQG-10	1000

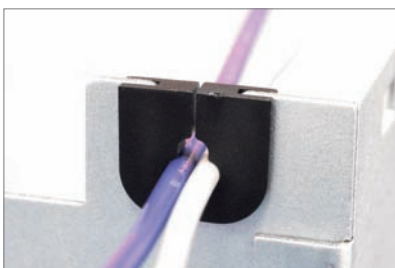

裝配孔尺寸，僅供參考
Mounting holes are for reference only.

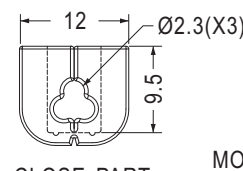
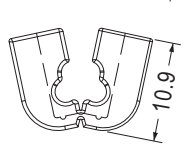
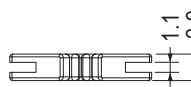

CLOSE PART

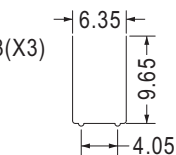

MOUNTING HOLE THICKNESS 0.8~1.0

Part No.	Package
SQG-8	1000

方型護線環 SQUARE SNAP BUSHING

用途：用於鐵板間電線出入刮傷之保護，不易脫落，使用方便，不佔空間之優點。

- Material: Nylon 66 (UL)
- Flame Class: 94V-2/94V-0
- Color: Natural/Black
- Unit: mm

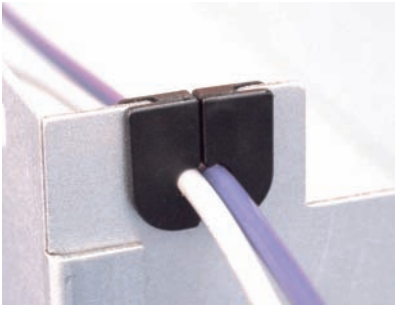

裝配孔尺寸，僅供參考
Mounting holes are for reference only.

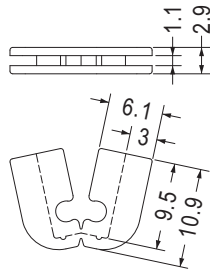

CLOSE PART

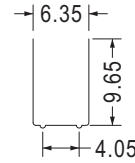

MOUNTING HOLE THICKNESS 0.8~1.0

Part No.	Package
SQG-12	1000



裝配孔尺寸，僅供參考
Mounting holes are for reference only.

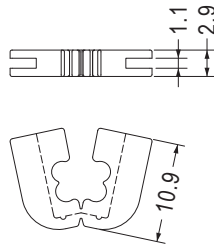

CLOSE PART

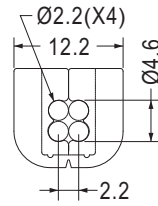

MOUNTING HOLE THICKNESS 0.8~1.0

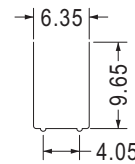

Part No.	Package
SQG-14	1000



裝配孔尺寸，僅供參考
Mounting holes are for reference only.

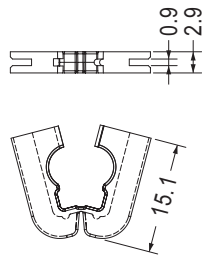

CLOSE PART

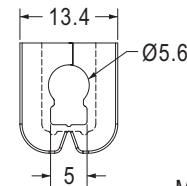

MOUNTING HOLE THICKNESS 0.8~1.0

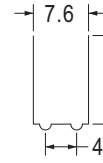

Part No.	Package
SQG-5	1000



裝配孔尺寸，僅供參考
Mounting holes are for reference only.

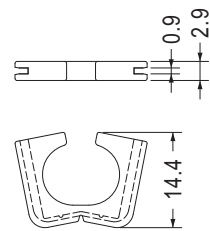

CLOSE PART

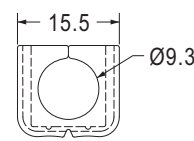

MOUNTING HOLE THICKNESS 0.8

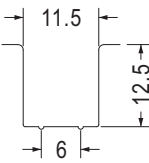

Part No.	Package
SQG-13	1000

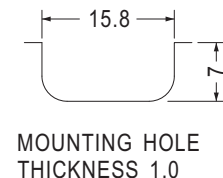
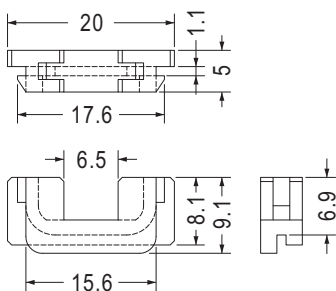

MOUNTING HOLE THICKNESS 1.0
(RECOMMEND FOR REFERENCE ONLY)

Part No.	Package
SQN-1	1000

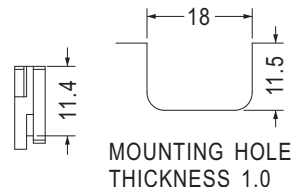
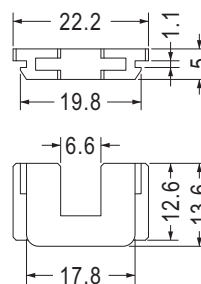

MOUNTING HOLE THICKNESS 1.0

Part No.	Package
SQN-2	1000

護線環 SNAP BUSHING

用途：用於電線、電纜之固定及保護。

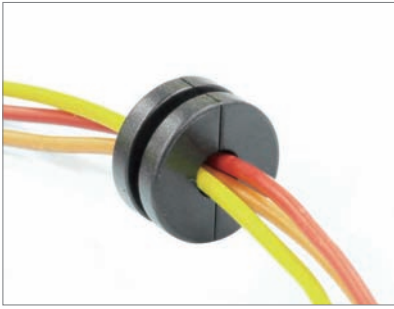

- Material: PC+ABS (UL)
- Flame Class: 94V-2/94V-0
- Color: Black
- Unit: mm

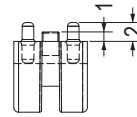
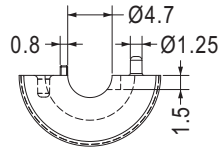
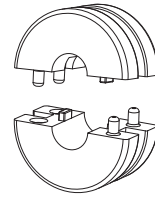
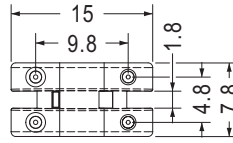

Part No.	Package
SBUT-1	1000

U型護線環 U TYPE SNAP BUSHING

用途：用於鐵板間電線出入刮傷之保護，不易脫落，使用方便，不佔空間之優點。

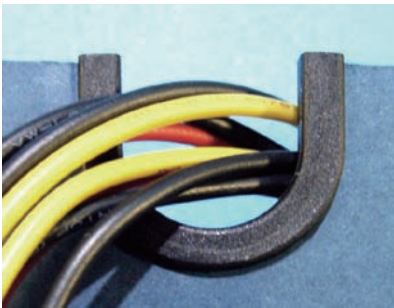

- Material: Nylon 66 (UL)
- Flame Class: 94V-2/94V-0
- Color: Natural/Black
- Unit: mm

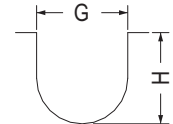
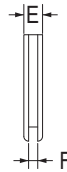
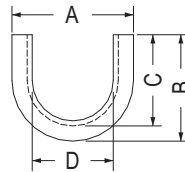

MOUNTING HOLE THICKNESS: T

裝配孔尺寸，僅供參考
Mounting holes are for reference only.

Part No.	A	B	C	D	E	F	G	H	T	Package
SQH-1	24.0	21.0	18.0	16.0	3.7	1.8	18.0	18.0	1.7~1.8	1000
SQH-2	24.3	27.0	24.5	17.5	3.9	1.9	19.3	24.5	1.7~1.8	
SQH-2L	24.3	27.0	24.5	17.5	4.1	2.1	19.3	24.5	2.0	
★SQH-6	28.3	29.5	26.5	20.7	4.0	2.0	22.0	26.7	1.6~1.8	

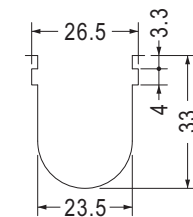
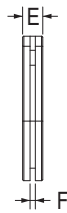
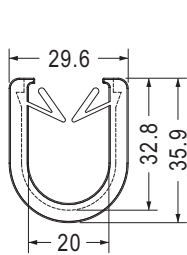

MOUNTING HOLE THICKNESS: T

Part No.	E	F	T	Package
SQM-1	5.0	1.3	0.8~1.2	1000
SQM-1L	5.8	2.1	2.0	

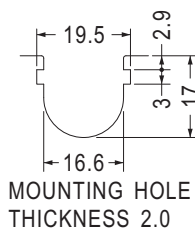
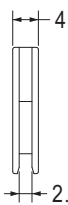
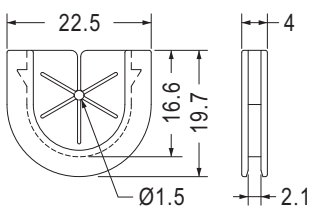

MOUNTING HOLE THICKNESS 2.0

- Material: PE
- Color: Natural
- Unit: mm

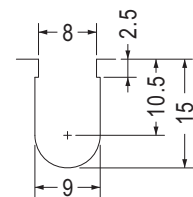
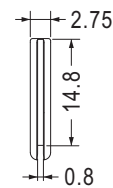
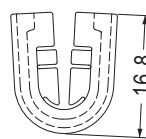

MOUNTING HOLE THICKNESS 0.6

Part No.	Package
SQHB-14	1000

Part No.	Package
SQHB-10	1000

U型護線環 U TYPE SNAP BUSHING

用途：用於鐵板間電線出入刮傷之保護，不易脫落，使用方便，不佔空間之優點。

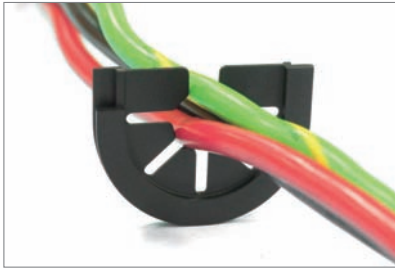

裝配孔尺寸，僅供參考
Mounting holes are for reference only.

- Material: Nylon 66 (UL)
- Flame Class: 94V-2/94V-0
- Color: Natural/Black
- Unit: mm

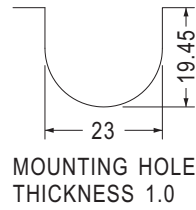
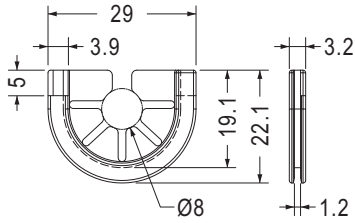

Part No.	Package
SQHB-1	1000

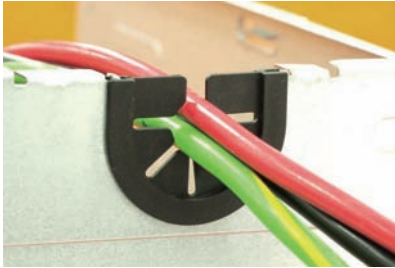

裝配孔尺寸，僅供參考
Mounting holes are for reference only.

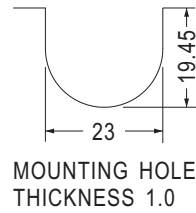
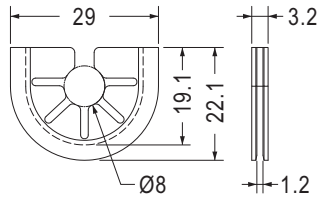

Part No.	Package
SQHB-7	1000



裝配孔尺寸，僅供參考
Mounting holes are for reference only.

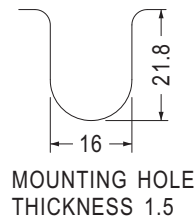
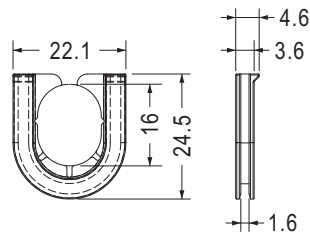

Part No.	Package
SQHB-5	1000



裝配孔尺寸，僅供參考
Mounting holes are for reference only.

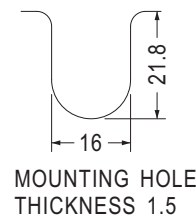
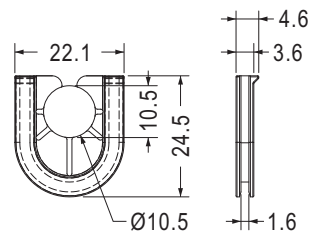

Part No.	Package
SQHB-6	1000



裝配孔尺寸，僅供參考
Mounting holes are for reference only.

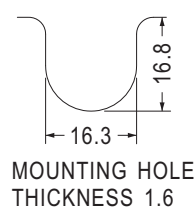
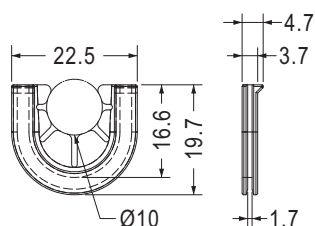

Part No.	Package
SQHB-3	1000

U型護線環 U TYPE SNAP BUSHING



裝配孔尺寸，僅供參考
Mounting holes are for reference only.

- Material: Nylon 66 (UL)
- Flame Class: 94V-2/94V-0
- Color: Natural/Black
- Unit: mm

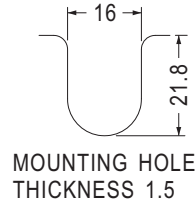
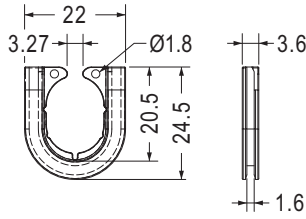

Part No.	Package
SQHB-8	1000

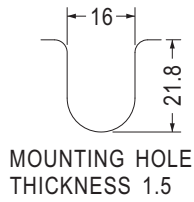
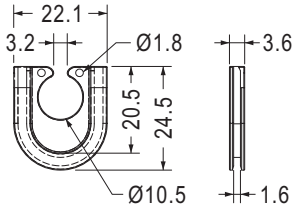

Part No.	Package
SQHB-9	1000

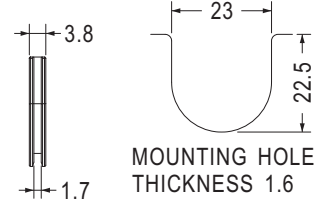
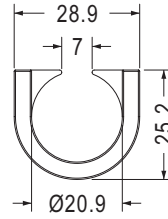

Part No.	Package
SQHB-13	1000

方型護線環 SQUARE SNAP BUSHING



裝配孔尺寸，僅供參考
Mounting holes are for reference only.

- Material: Nylon 66 (UL)
- Flame Class: 94V-2/94V-0
- Color: Natural/Black
- Unit: mm

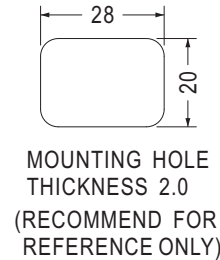
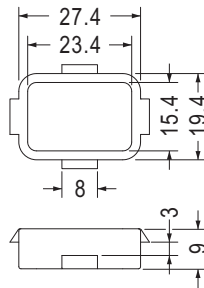

Part No.	Package
SQS-1	500

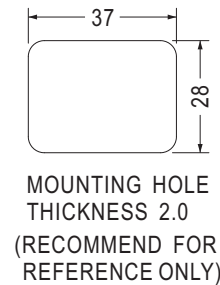
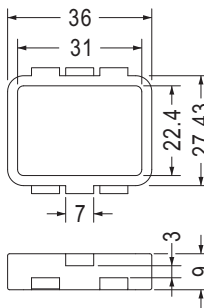
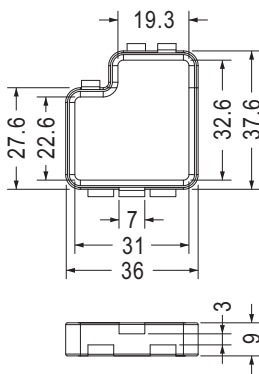

Part No.	Package
SQS-2	500

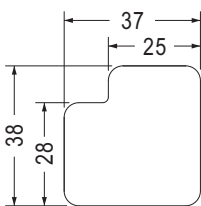

MOUNTING HOLE THICKNESS 2.0
(RECOMMEND FOR REFERENCE ONLY)

Part No.	Package
SQS-3	1000

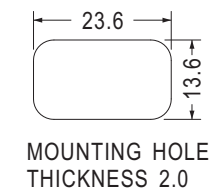
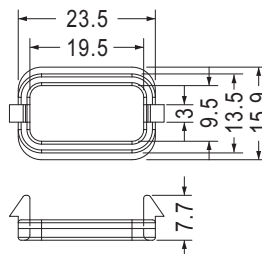

Part No.	Package
SQS-4	500

用途：用於鐵板間電線出入刮傷之保護，不易脫落，使用方便，不佔空間之優點。

用途：用於鐵板間電線出入刮傷之保護，不易脫落，使用方便，不佔空間之優點。

電線束線帶 CABLE TIE

用途：捆紮電線、物品。
✓本產品有成品UL安規。

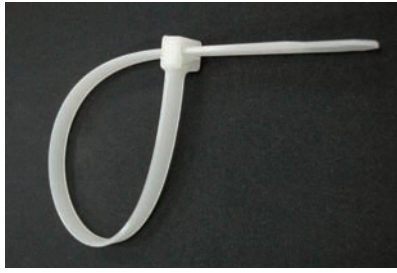

- Material: Nylon 66 (UL)
- Flame Class: 94V-2
- Color: Natural/Black
- Unit: mm
- UL Recognized

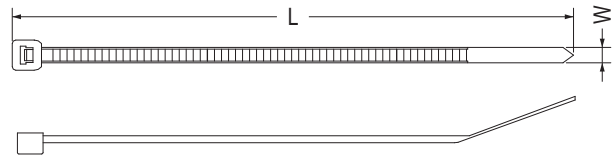

【 Self-Locking Tie 】

New Part No.	Part No.	Approx. Length	Approx. Width	Max. Bundle	Min. Loop Tensile Strength	Package	
		mm(in)	mm(in)				
		L	W				
GT-80M	YJ-80	80(3.15")	2.5(0.10")	17(0.67")	8(18)	1000	
GT-90M	YJ-90	90(3.54")	2.5(0.10")	21(0.83")	8(18)		
GT-100M	YJ-98	98(3.86")	2.5(0.10")	22(0.87")	8(18)		
GT-100M	YJ-100	100(4.00")	2.5(0.10")	23(0.91")	8(18)		
GT-120M	YJ-120	120(4.72")	2.5(0.10")	30(1.18")	8(18)		
GT-140M	YJ-142S	142(5.59")	2.5(0.10")	36(1.42")	8(18)		
GT-160M	YJ-160	160(6.30")	2.5(0.10")	42(1.66")	8(18)		
-----	YJ-181	181(7.13")	2.5(0.10")	49(1.92")	8(18)		
GT-200M	YJ-203S	203(8.00")	2.5(0.10")	56(2.21")	8(18)		
-----	YJ-102	102(4.00")	3.6(0.14")	22(0.87")	18(40)		
GT-120I	YJ-122	122(4.80")	3.6(0.14")	29(1.14")	18(40)	500	
GT-140I	YJ-142	142(5.59")	3.6(0.14")	34(1.34")	18(40)	1000	
-----	YJ-163	163(6.41")	3.6(0.14")	40(1.57")	18(40)	500	
GT-180I	YJ-185	185(7.28")	3.6(0.14")	47(1.85")	18(40)		
GT-200I	YJ-203	203(8.00")	3.6(0.14")	55(2.17")	18(40)		
GT-250I	YJ-232	232(9.13")	3.6(0.14")	63(2.48")	18(40)		
GT-250I	YJ-249	249(9.13")	3.6(0.14")	63(2.48")	18(40)		
-----	YJ-263	263(10.35")	3.6(0.14")	73(2.87")	18(40)		
GT-300I	YJ-295	295(11.61")	3.6(0.14")	83(3.27")	18(40)		
-----	YJ-331	331(13.00")	3.6(0.14")	96(3.78")	18(40)		
GT-370I	YJ-370	370(14.57")	3.6(0.14")	108(4.25")	18(40)		
GT-120ST	YJ-115	115(4.53")	4.8(0.19")	29(1.15")	23(50)		500
GT-150ST	YJ-140	140(5.50")	4.8(0.19")	34(1.34")	23(50)		
GT-160ST	YJ-162	162(6.38")	4.8(0.19")	42(1.66")	23(50)		
GT-190ST	YJ-188	188(7.40")	4.8(0.19")	49(1.93")	23(50)		
GT-200ST	YJ-201	201(8.00")	4.8(0.19")	53(2.08")	23(50)		
GT-216ST	YJ-216	216(8.50")	4.8(0.19")	58(2.28")	23(50)		
GT-250ST	YJ-242	242(9.53")	4.8(0.19")	66(2.60")	23(50)		
GT-266ST	YJ-266	266(10.47")	4.8(0.19")	72(2.84")	23(50)		
GT-300ST	YJ-292	292(11.50")	4.8(0.19")	82(3.23")	23(50)		
-----	YJ-330	330(13.00")	4.8(0.19")	93(3.66")	23(50)		
GT-370ST	YJ-368	368(14.49")	4.8(0.19")	106(4.17")	23(50)		
GT-430ST	YJ-410	410(16.14")	4.8(0.19")	122(4.80")	23(50)		
GT-450ST	YJ-450	450(17.72")	4.8(0.19")	135(5.31")	23(50)		
-----	YJ-148	148(5.83")	7.6(0.30")	36(1.42")	54(120)	100	
GT-200HD	YJ-182	182(7.17")	7.6(0.30")	46(1.81")	54(120)		
-----	YJ-215	215(8.46")	7.6(0.30")	59(2.32")	54(120)		
GT-250HD	YJ-254	254(10.00")	7.6(0.30")	71(2.80")	54(120)		
GT-300HD	YJ-293	293(11.54")	7.6(0.30")	84(3.30")	54(120)		
-----	YJ-332	332(13.00")	7.6(0.30")	95(3.74")	54(120)		
GT-370HD	YJ-368L	368(14.49")	7.6(0.30")	109(4.29")	54(120)		
-----	YJ-420	420(16.54")	7.6(0.30")	124(4.88")	54(120)		
-----	YJ-470	470(18.50")	7.6(0.30")	140(5.51")	54(120)		
-----	YJ-520	520(20.47")	7.6(0.30")	156(6.14")	54(120)		
-----	YJ-178	178(7.00")	9.0(0.35")	45(1.76")	80(175)		
-----	YJ-229	229(9.00")	9.0(0.35")	61(2.40")	80(175)		
-----	YJ-280	280(11.00")	9.0(0.35")	77(3.03")	80(175)		
-----	YJ-329	329(13.00")	9.0(0.35")	93(3.66")	80(175)		
-----	YJ-382	382(15.00")	9.0(0.35")	110(4.33")	80(175)		
-----	YJ-458	458(18.00")	9.0(0.35")	135(5.32")	80(175)		
GT-530HD	YJ-530	530(20.87")	9.0(0.35")	155(6.10")	80(175)		
-----	YJ-655	655(25.79")	9.0(0.35")	194(7.64")	80(175)		
GT-780HD	YJ-780	780(30.71")	9.0(0.35")	234(9.21")	80(175)		
GT-830HD	YJ-815	815(32.00")	9.0(0.35")	247(9.72")	80(175)		



- Material: Nylon 66 (UL)
- Flame Class: 94V-2
- Color: Natural/Black
- Unit: mm

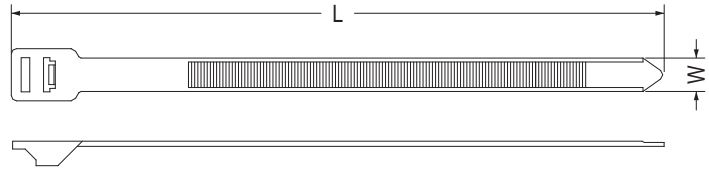

【 Self-Locking Tie 】

Part No.	Approx. Length mm(in)	Approx. Width mm(in)	Max. Bundle mm(in)	Min. Loop Tensile Strength kgs.(lbs.)	Package
	L	W			
YJ-228	228(9.00")	12.7(0.50")	54(2.12")	114(250)	100
YJ-256	256(10.00")		62(2.44")		
YJ-279	279(11.00")		70(2.75")		
YJ-305	305(12.00")		78(3.07")		
YJ-328	328(13.00")		86(3.38")		
YJ-355	355(14.00")		94(3.70")		
YJ-380	380(15.00")		102(4.00")		
YJ-405	405(16.00")		110(4.33")		
YJ-430	430(17.00")		118(4.64")		
YJ-455	455(18.00")		127(5.00")		
YJ-485	485(19.00")		135(5.31")		
YJ-510	510(20.00")		143(5.62")		
YJ-534	534(21.00")		151(5.94")		
YJ-560	560(22.00")		159(6.25")		
YJ-585	585(23.00")		167(6.57")		
YJ-610	610(24.00")		175(6.88")		
YJ-635	635(25.00")		183(7.20")		
YJ-660	660(26.00")		191(7.51")		
YJ-685	685(27.00")		199(7.83")		
YJ-710	710(28.00")		207(8.14")		
YJ-735	735(29.00")	215(8.46")			
YJ-760	760(30.00")	224(8.81")			
YJ-790	790(31.00")	232(9.13")			
YJ-813	813(32.00")	243(9.57")			
YJ-915	915(36.00")	274(10.79")			
YJ-1042	1042(41.00")	314(12.36")			



- Material: Nylon 66 (UL)
- Flame Class: 94V-2
- Color: Natural/Black
- Unit: mm

用途：捆紮電線、物品，此系列為可重複性使用。

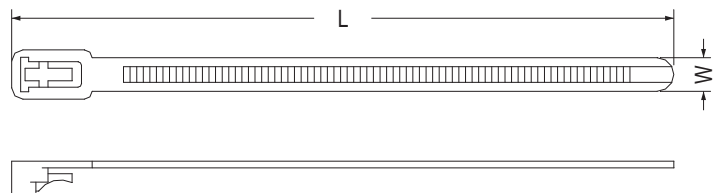

【 Releasable Tie 】

Part No.	Approx. Length mm(in)	Approx. Width mm(in)	Max. Bundle mm(in)	Min. Loop Tensile Strength kgs.(lbs.)	Package
	L	W			
YJ-R150	150(5.90")	7.5(0.295")	39(1.54")	23(50)	100
YJ-R200	200(7.87")		56(2.21")		
YJ-R250	250(9.84")		72(2.83")		

電線束線帶 CABLE TIE

用途：捆紮電線、物品，此系列為可重複性使用。



- Material: Nylon 66 (UL)
- Flame Class: 94V-2
- Color: Natural/Black
- Unit: mm

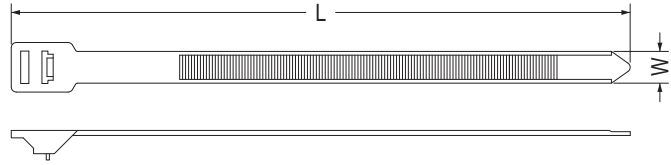

【 Releasable Tie 】

Part No.	Approx. Length	Approx. Width	Max. Bundle	Min. Loop Tensile Strength	Package
	mm(in)				
	L	W	mm(in)	kgs.(lbs.)	
YJ-R228	228(9.00")	12.7(0.50")	54(2.12")	114(250)	100
YJ-R256	256(10.00")		62(2.44")		
YJ-R279	279(11.00")		70(2.75")		
YJ-R305	305(12.00")		78(3.07")		
YJ-R328	328(13.00")		86(3.38")		
YJ-R355	355(14.00")		94(3.70")		
YJ-R380	380(15.00")		102(4.00")		
YJ-R405	405(16.00")		110(4.33")		
YJ-R430	430(17.00")		118(4.64")		
YJ-R455	455(18.00")		127(5.00")		
YJ-R485	485(19.00")		135(5.31")		
YJ-R510	510(20.00")		143(5.62")		
YJ-R534	534(21.00")		151(5.94")		
YJ-R560	560(22.00")		159(6.25")		
YJ-R585	585(23.00")		167(6.57")		
YJ-R610	610(24.00")		175(6.88")		
YJ-R635	635(25.00")		183(7.20")		
YJ-R660	660(26.00")		191(7.51")		
YJ-R685	685(27.00")		199(7.83")		
YJ-R710	710(28.00")		207(8.14")		
YJ-R735	735(29.00")	215(8.46")			
YJ-R760	760(30.00")	224(8.81")			
YJ-R790	790(31.00")	232(9.13")			
YJ-R813	813(32.00")	243(9.57")			
YJ-R915	915(36.00")	274(10.79")			
YJ-R1042	1042(41.00")	314(12.36")			

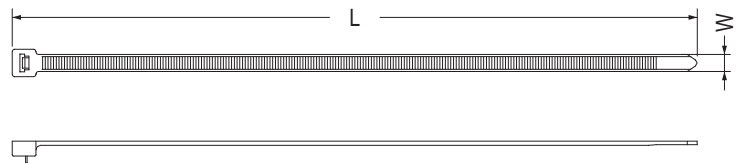

【 Releasable Tie 】

Part No.	Approx. Length	Approx. Width	Max. Bundle	Min. Loop Tensile Strength	Package
	mm(in)				
	L	W	mm(in)	kgs.(lbs.)	
YJ-R300	300(11.81")	7.6(0.30")	86(3.38")	23(50)	100
YJ-R350	350(13.87")		102(4.02")		
YJ-R400	400(15.75")		118(4.65")		
YJ-R655	655(25.79")	9.0(0.35")	194(7.64")	80(175)	
YJ-R780	780(30.71")		234(9.21")		
YJ-R815	815(32.00")		247(9.72")		

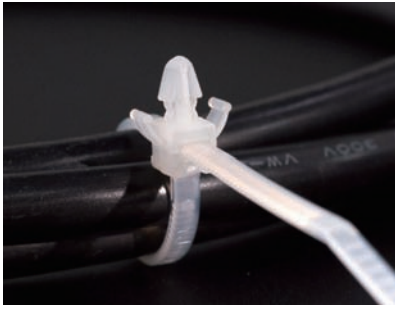

- Material: Nylon 66 (UL)
- Flame Class: 94V-2
- Color: Natural/Black
- Unit: mm

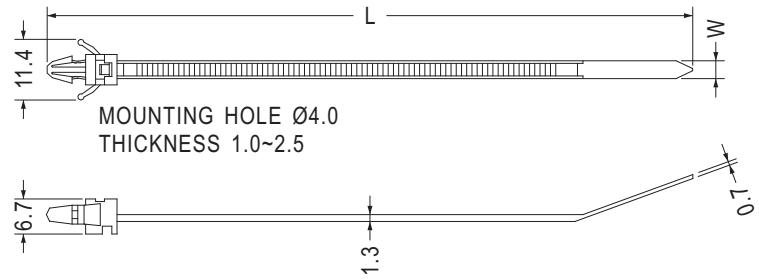

【 Push Self-Locking Tie 】

Part No.	Approx. Length	Approx. Width	Max. Bundle	Min. Loop	Package
	mm(in)	mm(in)			
YJ-123	L	W	mm(in)	kgs.(lbs.)	
YJ-123	123(4.84")	3.4(0.13")	25.4(1.00")	18(40)	500



- Material: Nylon 66 (UL)
- Flame Class: 94V-2
- Color: Natural/Black
- Unit: mm

用途：捆紮電線、物品，此系列為可重複性使用。

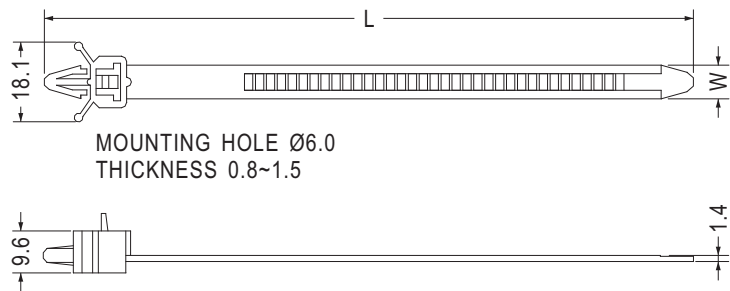

【 Push Releasable Tie 】

Part No.	Approx. Length	Approx. Width	Max. Bundle	Min. Loop	Package
	mm(in)	mm(in)			
YJ-R151	L	W	mm(in)	kgs.(lbs.)	
YJ-R151	151(6.00")	7.8(0.30")	37(1.45")	40(88)	100
YJ-R191	191(7.50")		49(1.92")		
YJ-R231	231(9.00")		62(2.44")		

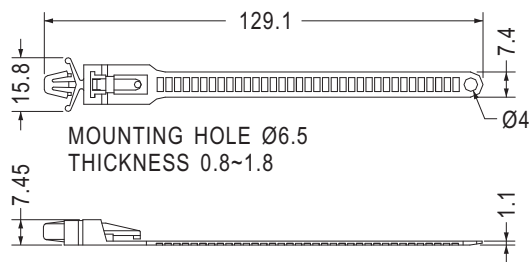

Part No.	Package
KYCB-129	250

電線束線帶 CABLE TIE

用途：捆紮電線、物品。
 ✓本產品有成品UL安規。

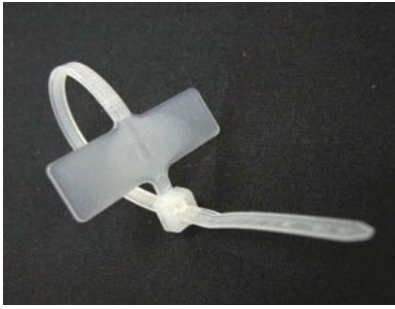

- Material: Nylon 66 (UL)
- Flame Class: 94V-2
- Color: Natural/Black
- Unit: mm
- UL Recognized

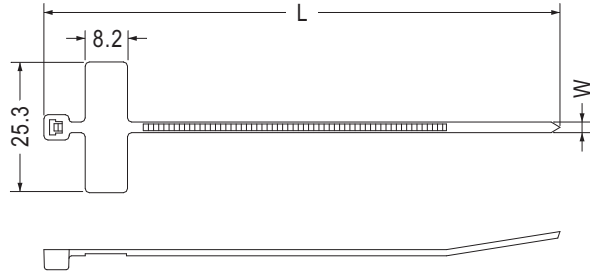

【 Marker Tie 】

Part No.	Approx. Length mm(in)	Approx. Width mm(in)	Max. Bundle mm(in)	Min. Loop Tensile Strength kgs.(lbs.)	Package
	L	W			
YJ-98X	100(4.00")	2.5(0.10")	22(0.87")	8(18)	500

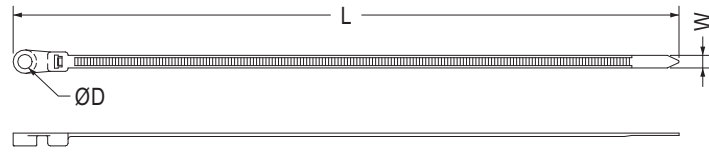

【 Clamp Mounting Tie 】

Part No.	D	Approx. Length mm(in)	Approx. Width mm(in)	Max. Bundle mm(in)	Min. Loop Tensile Strength kgs.(lbs.)	Package
		L	W			
YJ-110	3.2	110(4.33")	2.8(0.11")	23(0.91")	10(22)	500
YJ-156	4.2	156(6.14")	3.6(0.14")	35(1.38")	18(40)	1000
YJ-205	5.4	205(8.00")	4.8(0.19")	51(2.01")	23(50)	
YJ-255	5.4	255(10.00")	4.8(0.19")	67(2.64")	23(50)	
YJ-304	5.4	304(12.00")	4.8(0.19")	83(3.27")	23(50)	500
YJ-356	5.4	356(14.00")	4.8(0.19")	101(3.98")	23(50)	
YJ-406	5.4	406(16.00")	4.8(0.19")	118(4.64")	23(50)	
YJ-230	6.4	230(9.00")	7.6(0.30")	58(2.28")	54(120)	100
YJ-306	6.4	306(12.00")	7.6(0.30")	84(3.31")	54(120)	
YJ-381	6.4	381(15.00")	7.6(0.30")	108(4.25")	54(120)	
YJ-460	6.4	460(18.00")	7.6(0.30")	133(5.24")	54(120)	
YJ-535	6.4	535(21.00")	7.6(0.30")	155(6.10")	54(120)	

電線束線帶 CABLE TIE

用途：捆紮電線、物品。
 ✓本產品有成品UL安規。

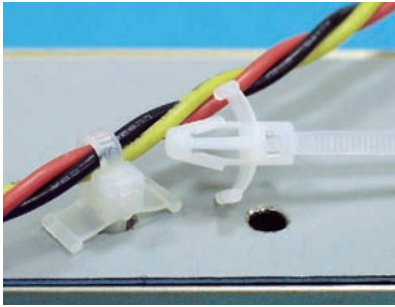

- Material: Nylon 66 (UL)
- Flame Class: 94V-2
- Color: Natural/Black
- Unit: mm
- UL Recognized

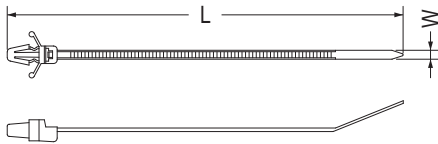

[GTP-130ST, GTP-170ST, GTP-190ST, GTP-110M]

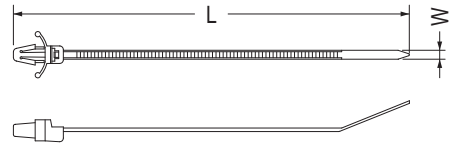

[GTP-110MA]

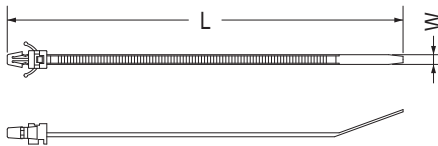

[GTP-130I]

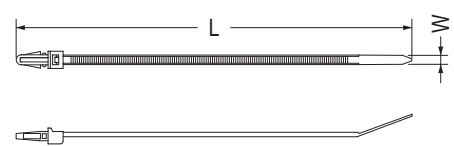

[GTP-150I, GTP-200ST]

Part No.	Approx. Length mm(in)	Approx. Width mm(in)	Max. Bundle mm(in)	Min. Loop Tensile Strength kgs.(lbs.)	Hole Diameter Chassis mm(in)	Max. Panel Thickness mm(in)	Package
	L	W					
GTP-130ST	132(5.12")	4.8(0.19")	25(0.98")	22.2(50)	6.4(0.252")	3.2(0.126")	1000
GTP-170ST	175(6.69")	4.8(0.19")	38(1.50")	22.2(50)	6.4(0.252")	3.2(0.126")	
GTP-190ST	200(7.68")	4.8(0.19")	45(1.77")	22.2(50)	6.4(0.252")	3.2(0.126")	
GTP-110M	110(4.33")	2.5(0.10")	22(0.87")	8.1(18)	4.8~5.0 (0.189")~(0.197")	0.8~2.4 (0.03")~(0.09")	
GTP-110MA							
GTP-130I	130(5.12")	3.2(0.13")	28(1.10")	13.6(30)	4.0(0.157")	1.0~2.0	
GTP-150I	150(5.91")	3.6(0.14")	32(1.26")	13.6(30)	5.2(0.205")	1.0~2.8	
GTP-200ST	200(7.87")	4.8(0.19")	46(1.81")	22.2(50)	6.3(0.248")	3.6(0.141")	



- Material: Nylon 66 (UL)
- Flame Class: 94V-2
- Color: Natural/Black
- Unit: mm

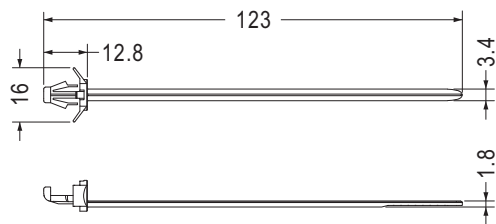

MOUNTING HOLE Ø5.4
 THICKNESS 2.0~3.2

Part No.	Package
STCC-123	500

電源線收線帶 STRAP TIE

用途：捆紮電線、物品。

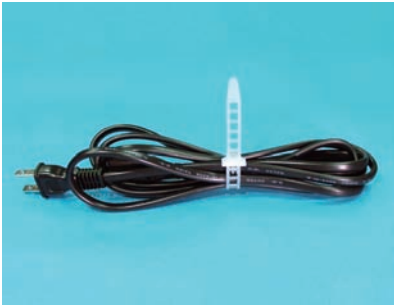

- Material: Nylon 66 (UL)/PE
- Flame Class: 94V-2
- Color: Natural/Black
- Unit: mm

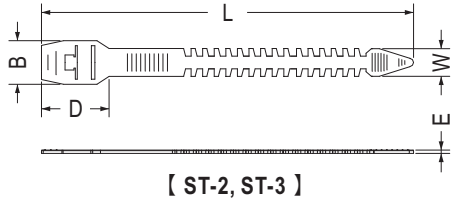
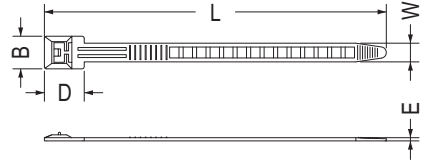

Part No.	B	D	E	L	W	Package
ST-1SN	15.0	18.3	1.5	157.0	8.6	500
ST-1	15.0	18.3	1.5	157.0	8.6	
ST-2	15.8	21.4	1.2	135.0	10.0	
ST-3	15.4	24.5	1.2	140.0	10.0	
ST-4	15.0	18.3	1.7	205.0	8.6	
ST-5	13.0	16.0	1.45	125.0	7.5	
ST-5NS	13.0	16.0	1.0	125.0	7.5	
ST-11N	15.0	18.3	1.7	300.0	8.6	



- Material: TPE
- Color: Black/Blue
- Unit: mm

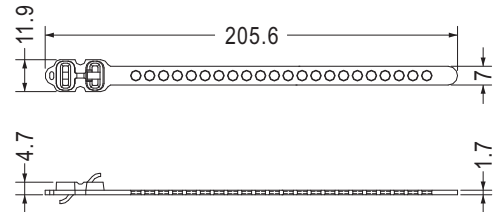

Part No.	Package
ST-6	250

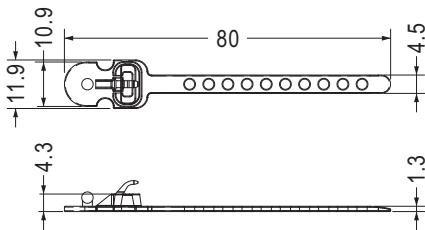

Part No.	Package
ST-13	500

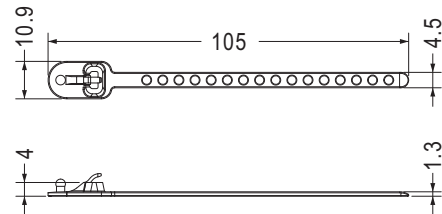

Part No.	Package
ST-15	500



- Material: PE
- Color: Natural
- Unit: mm

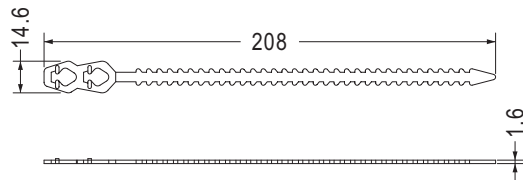

Part No.	Package
ST-7	500

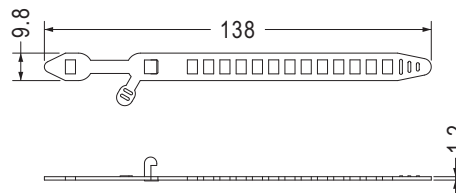

- Color: Black

Part No.	Package
ST-8	500

珠型束線帶 STRAP TIE

用途：捆紮電線、物品。



- Material: PP (UL)
- Flame Class: 94HB
- Color: Natural
- Unit: mm

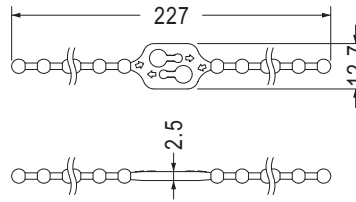

Part No.	Package
ST-23	200



- Material: Nylon 66 (UL)
- Flame Class: 94V-2/94V-0
- Color: Natural/Black
- Unit: mm

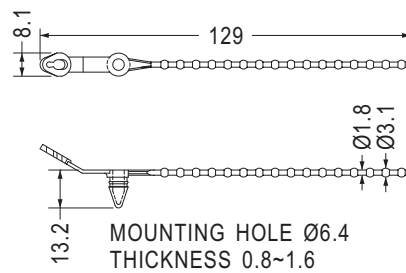

Part No.	Package
ST-9	500

5

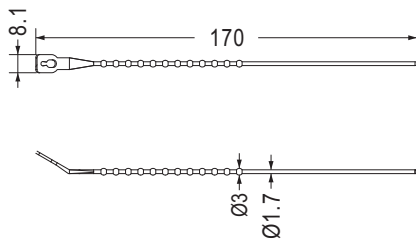

Part No.	Package
ST-19	500

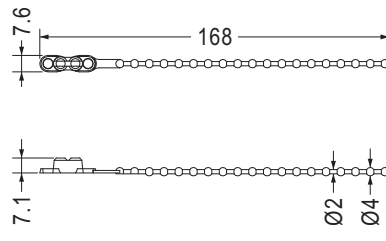

Part No.	Package
STO-166	500

- Material: PE
- Color: Natural

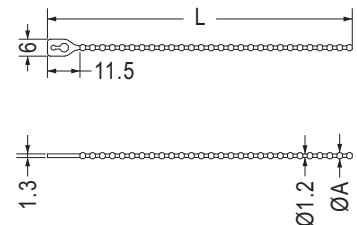

Part No.	A	L	Package
GTB-70	2.4	70.0	1000
GTB-100	2.3	112.0	

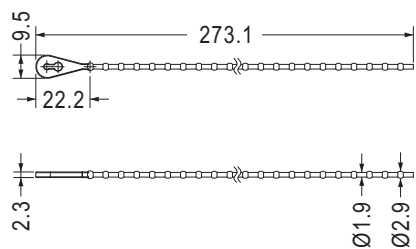

Part No.	Package
GTBA-273	500

- Material: PP
- Color: Natural

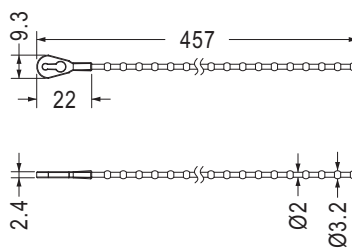

Part No.	Package
GTBA-457	500

- Material: PP (UL)
- Flame Class: 94HB
- Color: Natural

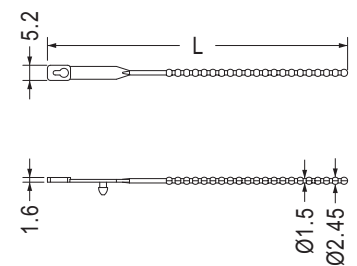

MOUNTING HOLE Ø3.0
THICKNESS 0.6~1.8

Part No.	L	Package
GTB-85	85.0	1000
GTB-103	103.0	

電線束線帶 CABLE TIE

用途：捆紮電線、物品。

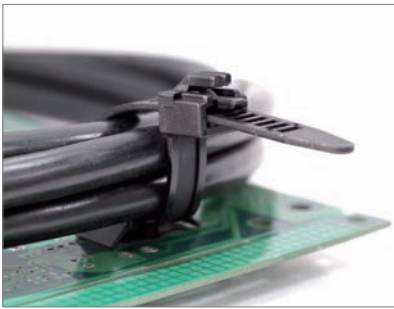

- Material: Nylon 66 (UL)
- Flame Class: 94V-2/94V-0
- Color: Natural/Black
- Unit: mm

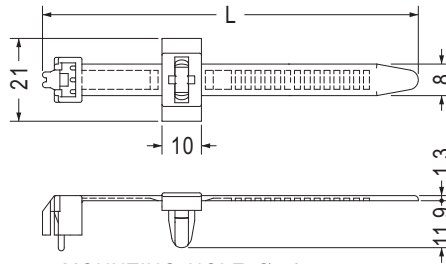

MOUNTING HOLE Ø7.0
THICKNESS 4.0

Part No.	L	Package
STC-115	115.3	200
STC-175	175.0	

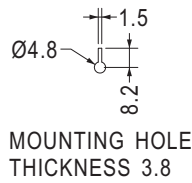
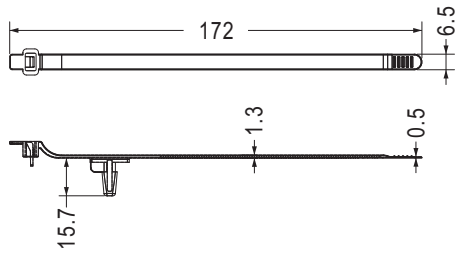

MOUNTING HOLE Ø4.8
THICKNESS 3.8

Part No.	Package
STC-173	200

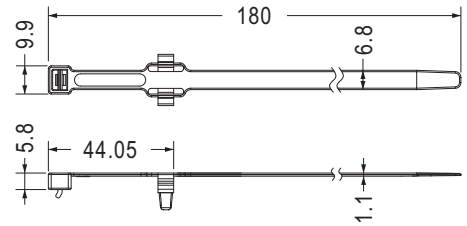

MOUNTING HOLE Ø5.5
THICKNESS: T

Part No.	T	Package
STC-180	0.8~2.0	200
STC-180L	2.3~2.5	

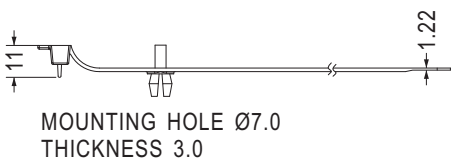

MOUNTING HOLE Ø7.0
THICKNESS 3.0

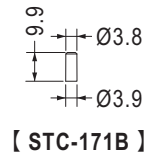

【 STC-171B 】

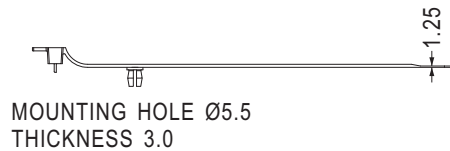

MOUNTING HOLE Ø5.5
THICKNESS 3.0

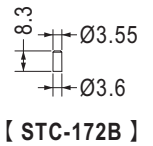

【 STC-172B 】

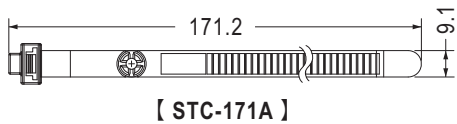

【 STC-171A 】

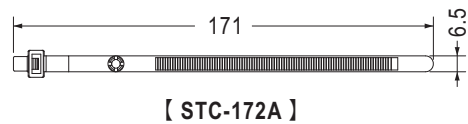

【 STC-172A 】

Part No.	組 合 件 (ASSY)	Package
STC-171	STC-171A+STC-171B	250

Part No.	Part No.	Package
STC-172	STC-172A	100
	STC-172B	
此為子母包:內容物包含右方零件		

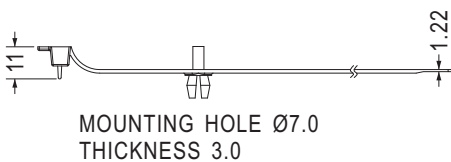

MOUNTING HOLE Ø7.0
THICKNESS 3.0

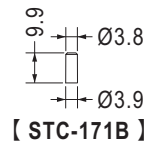

【 STC-174B 】

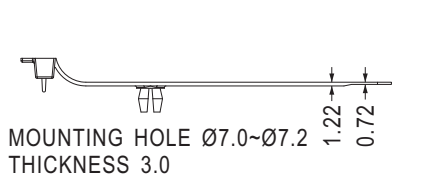

MOUNTING HOLE Ø7.0~Ø7.2
THICKNESS 3.0

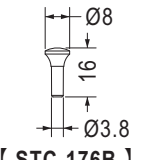

【 STC-176B 】

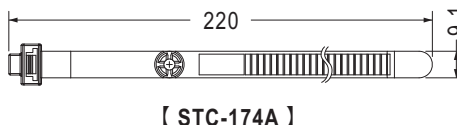

【 STC-174A 】

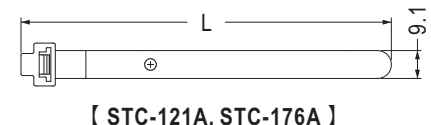

【 STC-121A, STC-176A 】

Part No.	Part No.	Package
STC-174	STC-174A	100
	STC-174B	
此為子母包:內容物包含右方零件		

Part No.	Part No.	L	Package
STC-121	STC-121A	121.0	100
	STC-176B		
STC-176	STC-176A	171.2	100
	STC-176B		
此為子母包:內容物包含右方零件			

電線束線帶 CABLE TIE

用途：捆紮電線、物品。

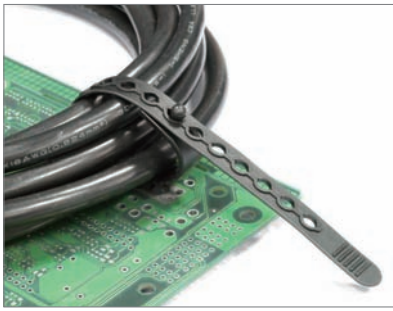

- Material: PE
- Color: Black
- Unit: mm

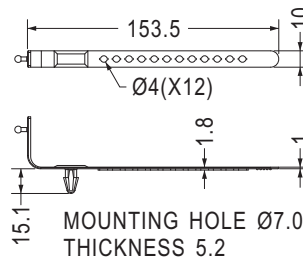

Part No.	Package
STCA-161	500

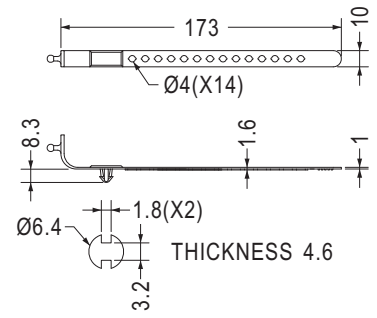

Part No.	Package
STCA-172	500



- Material: Nylon 66 (UL)
- Flame Class: 94V-2/94V-0
- Color: Natural/Black
- Unit: mm

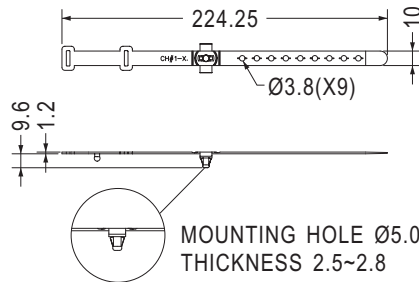

Part No.	Package
STCA-224	500

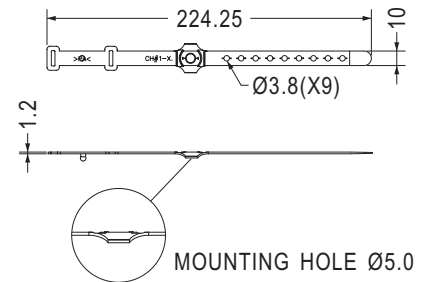

Part No.	Package
STCA-225	500

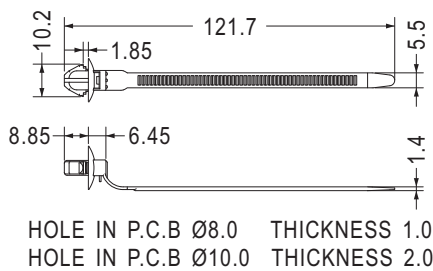

Part No.	Package
STCB-110	1000

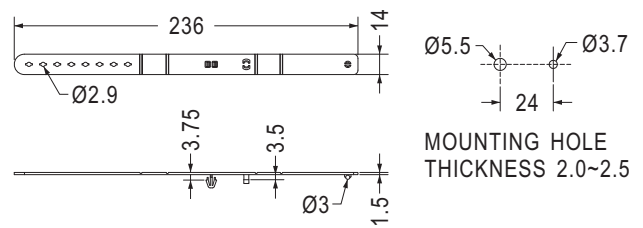

Part No.	Package
STCA-235	500

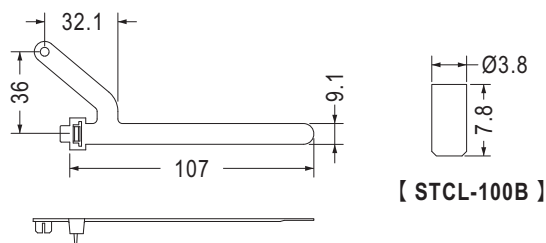

Part No.	組合物(ASSY)	Package
STCL-100	STCL-100A+STCL-100B	100

電源線束線帶 STRAP TIE

用途：捆紮電線、物品。

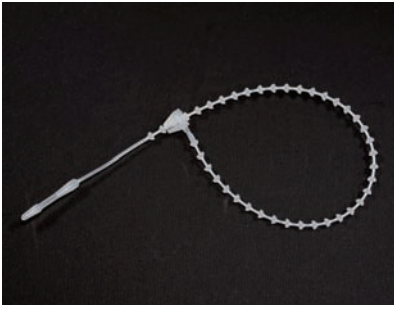

- Material: Nylon 66 (UL)
- Flame Class: 94V-2/94V-0
- Color: Natural/Black
- Unit: mm

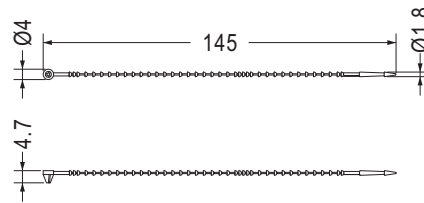

Part No.	Package
LOCK-145	1000

- Material: PP
- Color: Natural
- Unit: mm

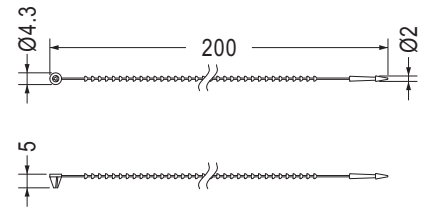

Part No.	Package
LOCK-200	1000

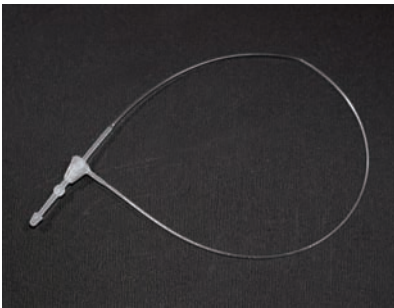

- Material: PP
- Color: Natural
- Unit: mm

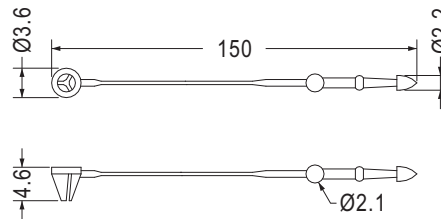

Part No.	Package
LOCK-150	1000

5

水管座 PIPE MOUNT TIE

用途：車用管材之固定。



- Material: Nylon 66 (UL)
- Flame Class: 94V-2/94V-0
- Color: Black
- Unit: mm

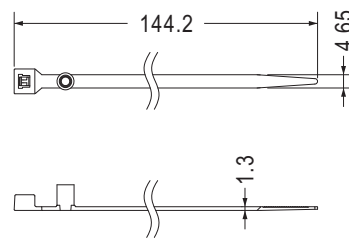

【 SWPK-15A 】

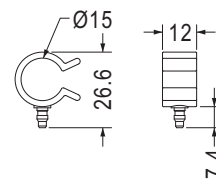

【 SWPK-1B 】

Part No.	組零件(ASSY)	Package
SWPK-15F	SWPK-15A+SWPK-1B	100

吊勾 HANDLE GRIP

用途：用於電線之固定。

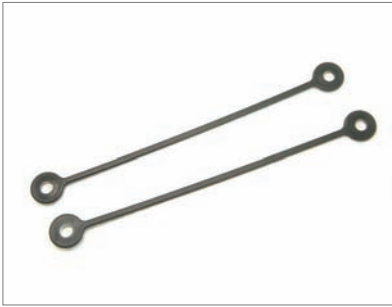

- Material: PE
- Color: White/Black
- Unit: mm

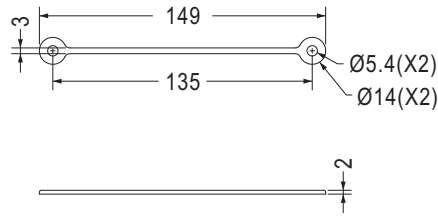

Part No.	Package
SFA-1	1000

束線座 CABLE MOUNT

用途：配合寬度2.5mm束線帶，可固定電線於機板上。

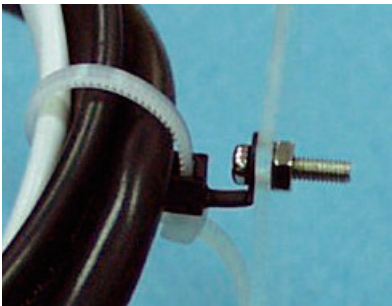

- Material: Nylon 66 (UL)
- Flame Class: 94V-2/94V-0
- Color: Natural/Black
- Unit: mm

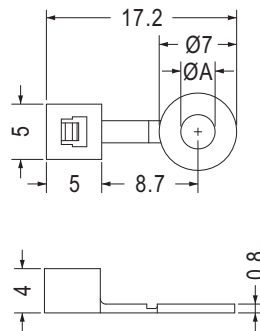

Part No.	A	Package
ASUS-1	2.8	2000
ASUS-3	3.1	

束線帶扣 CABLE TIE BUCKLE

用途：用於束線帶定位與固定用。

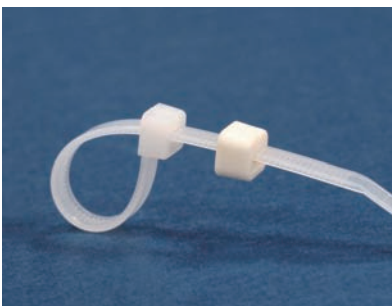

- Material: Nylon 66 (UL)
- Flame Class: 94V-2/94V-0
- Color: Natural/Black
- Unit: mm

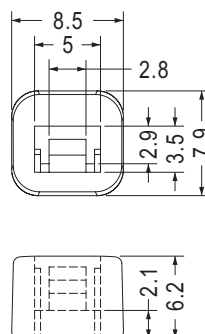

Part No.	Package
YJHH-4.8	1000

黏扣帶 VELCRO

用途：捆紮電線、物品。

依不同尺寸，可接受訂製。
Different size available per request.



- Material: Nylon/Nylon(UL)
- Flame Class: 94V-2
- Color: Black
- Unit: mm

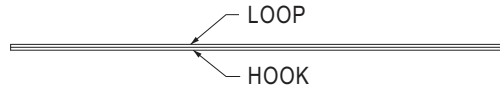
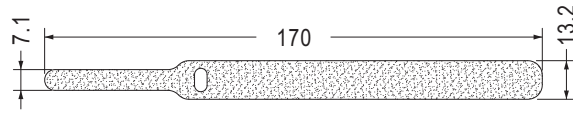

Part No.	Package
VCO-7NL	500

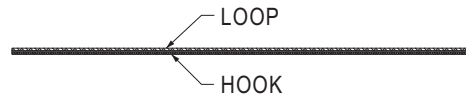
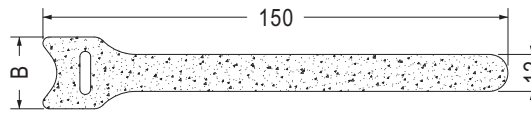
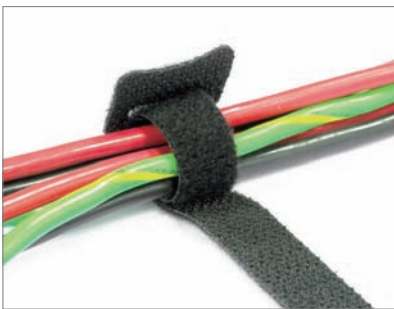

Part No.	B	Package
VCO15023	23.3	500
★VCO-39	24.0	

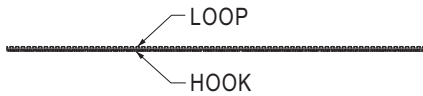
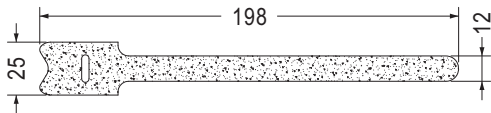

Part No.	Package
VCO19812	500

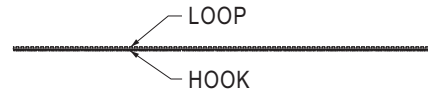
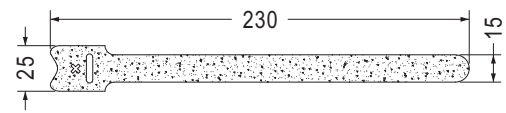

Part No.	Package
VCO23015	500

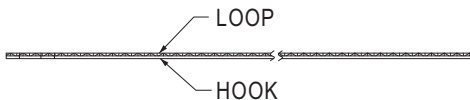
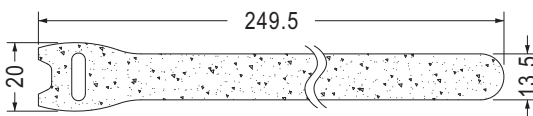

Part No.	Package
VCO25020	500

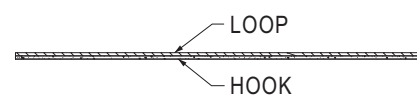
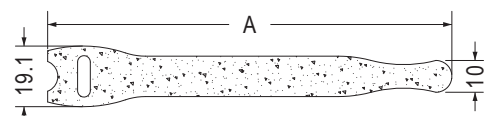

Part No.	A	Package
VCO-888	127.0	500
VCO-888-1	155.0	

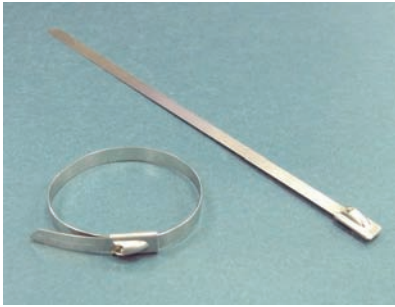

- Material: SUS
- Unit: mm

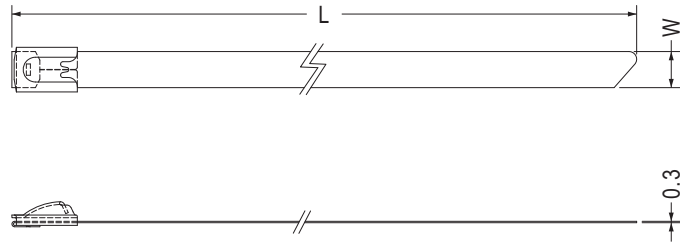

【 Self-Locking Tie 】

Part No.	Max. Bundle mm(in)	Approx. Length	Approx. Width	Min. Loop Tensile Strength kgs.(lbs.)	Package
		mm(in) L	mm(in) W		
STB-152S	25(1.00")	152(6.00")	4.5(0.177")	45.3(100)	100
STB-200S	50(2.00")	200(8.00")			
STB-360S	102(4.00")	360(14.0")			
STB-520S	152(6.00")	520(20.0")			
STB-680S	203(8.00")	680(27.0")			
STB-840S	254(10.0")	840(33.0")			
STB-1050S	318(12.5")	1050(41.0")			50

Part No.	Max. Bundle mm(in)	Approx. Length	Approx. Width	Min. Loop Tensile Strength kgs.(lbs.)	Package
		mm(in) L	mm(in) W		
STB-152M	25(1.00")	152(6.00")	8.0(0.315")	113.3(250)	100
STB-200M	50(2.00")	200(8.00")			
STB-360M	102(4.00")	360(14.0")			
STB-520M	152(6.00")	520(20.0")			
STB-680M	203(8.00")	680(27.0")			
STB-840M	254(10.0")	840(33.0")			
STB-1050M	318(12.5")	1050(41.0")			50

Part No.	Max. Bundle mm(in)	Approx. Length	Approx. Width	Min. Loop Tensile Strength kgs.(lbs.)	Package
		mm(in) L	mm(in) W		
STB-290L	80(3.10")	290(11.0")	12.0(0.472")	272.0(600)	50
STB-360L	102(4.00")	360(14.0")			
STB-430L	121(4.70")	430(17.0")			
STB-520L	152(6.00")	520(20.0")			
STB-600L	175(6.80")	600(24.0")			
STB-680L	203(8.00")	680(27.0")			
STB-750L	230(8.70")	750(30.0")			
STB-840L	254(10.0")	840(33.0")			
STB-910L	273(10.7")	910(36.0")			
STB-1000L	302(11.9")	1000(39.0")			25
STB-1070L	325(12.8")	1070(42.0")			
STB-1200L	351(13.8")	1200(47.0")			

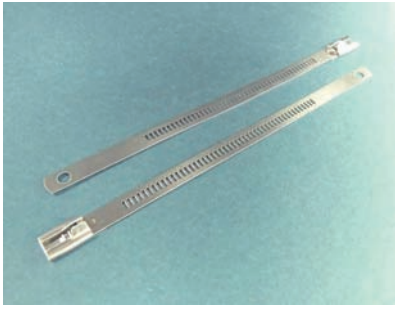

- Material: SUS
- Unit: mm

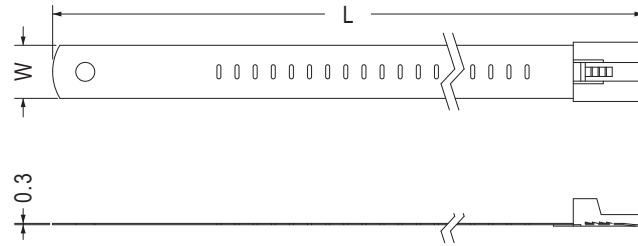

【 Self-Locking Tie 】

Part No.	Max. Bundle mm(in)	Approx. Length mm(in)	Approx. Width mm(in)	Min. Loop Tensile Strength kgs.(lbs.)	Package
		L	W		
STL-150S	22(0.86")	150(5.90")	7.0(0.28")	113.4(250)	100
STL-195S	45(1.70")	195(8.00")			
STL-255S	64(2.50")	255(10.0")			
STL-335S	89(3.50")	335(13.0")			
STL-490S	139(5.40")	490(19.0")			
STL-635S	185(7.20")	635(25.0")			

Part No.	Max. Bundle mm(in)	Approx. Length mm(in)	Approx. Width mm(in)	Min. Loop Tensile Strength kgs.(lbs.)	Package
		L	W		
STL-150M	22(0.86")	150(5.90")	12.0(0.472")	113.4(250)	100
STL-195M	45(1.70")	195(8.00")			
STL-255M	64(2.50")	255(10.0")			
STL-335M	89(3.50")	335(13.0")			
STL-490M	139(5.40")	490(19.0")			
STL-635M	185(7.20")	635(25.0")			

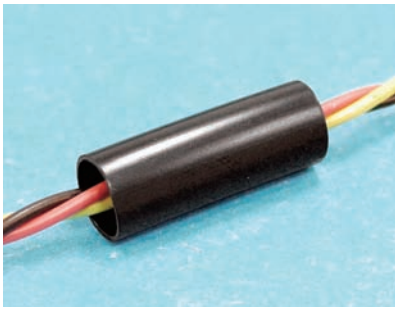

- Material: P.V.C (UL)
- Flame Class: VW-1
- Color: Black/Transparent
- Unit: mm

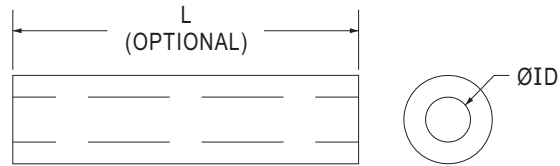

Package			
Part No.	Feet/1 Roll	M/1 Roll	mm/1 Roll
P0.864~P5.94	1000	304.8	304800
P6.68~P11.1B	500	152.4	152400
P12.7B			
P11.1	250	76.2	76200
P12.7			

Part No.	Size AWG	Inside Diameter	Cat.No. DEV-300(300V.105°C)			Cat.No. DEV-600 (600V.105°C)		
			Outside Diameter	Average Thickness	Min. Thickness At Any Point	Outside Diameter	Average Thickness	Min. Thickness At Any Point
P0.864	20	0.864	1.70	0.40	0.330	2.10	0.60	0.431
P0.965	19	0.965	1.80	0.40	0.330	2.20		
P1.067	18	1.067	1.90	0.40	0.330	2.30		
P1.19	17	1.19	2.00	0.40	0.330	2.60		
P1.34	16	1.34	2.15	0.40	0.330	2.75		
P1.50	15	1.5	2.30	0.40	0.330	2.90		
P1.68	14	1.68	2.50	0.40	0.330	3.10		
P1.93	13	1.93	2.70	0.40	0.330	3.35		
P2.16	12	2.16	3.00	0.40	0.330	3.60		
P2.41	11	2.41	3.20	0.40	0.330	3.80		
P2.69	10	2.69	3.50	0.40	0.330	4.10	0.70	0.559
P3.00	9	3.00	4.10	0.55	0.431	4.40		
P3.38	8	3.38	4.50	0.55	0.431	4.80		
P3.76	7	3.76	4.90	0.55	0.431	5.20		
P4.22	6	4.22	5.35	0.55	0.431	5.65		
P4.72	5	4.72	5.85	0.55	0.431	6.15		
P5.28	4	5.28	6.40	0.55	0.431	6.70		
P5.94	3	5.94	7.05	0.55	0.431	7.35		
P6.68	2	6.68	7.80	0.55	0.431	8.10		
P7.47	1	7.47	8.60	0.55	0.431	8.90		
P8.38	0	8.38	9.50	0.55	0.431	9.80		
P7.92	5/16"	7.92				9.35		
P9.53	3/8"	9.53				10.95		
P11.1	7/16"	11.10				12.50		
P12.7	1/2"	12.70				14.10		

熱縮套管 HEAT SHRINK TUBING

用途：用於電線、零件接頭之絕緣。

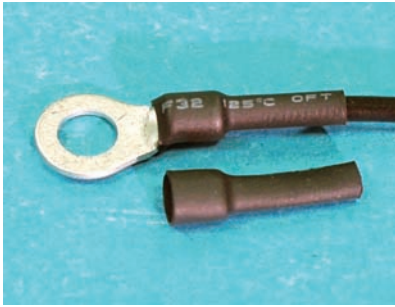

- Material: Polyolefin (UL)
- Flame Class: VW-1
- Color: Black
- Unit: mm

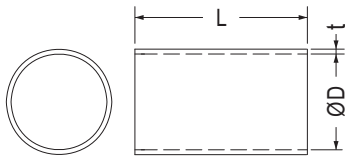

Part No.	收縮前狀態 Dimensions Before Shrinkage		收縮後狀態 Dimensions After Shrinkage		Package	
	內徑(D) Inside Dia.	管壁厚度(t) Thickness	內徑 Inside Dia.	管壁厚度(t) Thickness	M/1 Roll	mm/1 Roll
Ø1.0	1.3	0.2	0.5	0.33	200	200000
Ø1.5	2.0	0.2	0.75	0.36		
Ø2.0	2.5	0.2	1.0	0.44		
Ø2.5	3.0	0.25	1.25	0.44		
Ø3.0	3.5	0.25	1.5	0.44		
Ø3.5	4.0	0.25	1.75	0.44		
Ø4.0	4.5	0.25	2.0	0.44	100	100000
Ø5.0	5.4	0.25	2.5	0.56		
Ø6.0	6.4	0.25	3.0	0.56		
Ø7.0	7.4	0.25	3.5	0.56		
Ø8.0	8.4	0.25	4.0	0.56		
Ø9.0	9.4	0.25	4.5	0.56		
Ø10.0	10.4	0.25	5.0	0.56	50	50000
Ø11.0	11.4	0.25	5.5	0.56		
Ø12.0	12.4	0.25	6.0	0.56		
Ø13.0	13.5	0.3	6.5	0.69		
Ø14.0	14.5	0.3	7.0	0.69		
Ø15.0	15.5	0.3	7.5	0.69		
Ø16.0	16.8	0.3	8.0	0.69		
Ø18.0	18.7	0.35	9.0	0.77		
Ø20.0	21.2	0.35	10.0	0.77		
Ø22.0	23.2	0.4	11.0	0.77		
Ø25.0	26.1	0.4	12.5	0.87		
Ø28.0	29.0	0.5	14.0	0.87		
Ø30.0	32.0	0.5	14.8	0.87		
Ø35.0	37.0	0.5	17.5	0.87		
Ø40.0	43.0	0.5	20.0	0.97		
Ø50.0	53.0	0.5	24.7	0.97		

織布管 SILICON FIBERGLASS SLEEVING

用途：用於電線之絕緣。

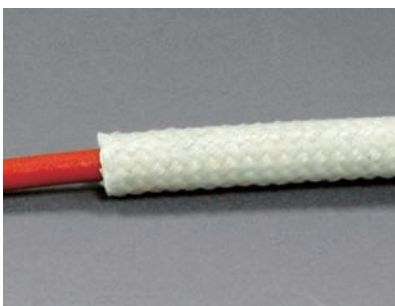

- Material: Glass-Fiber
- Color: White
- Unit: mm

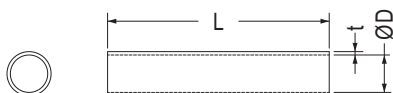

Part No.	內徑(D) Inside Diameter	管壁厚度(t) Thickness	Package	
			M/1 Roll	mm/1 Roll
T1	1.0	0.28	200	200000
T2	2.0	0.28		
T3	3.0	0.28		
T4	4.0	0.30	100	100000
T5	5.0	0.30		
T6	6.0	0.30		
T7	7.0	0.30		
T8	8.0	0.35	50	50000
T9	9.0	0.35		
T10	10.0	0.35		
T12	12.0	0.36		
T14	14.0	0.36		
T16	16.0	0.36		

把手 HANDLE

用途：用於PC板之拉拔。

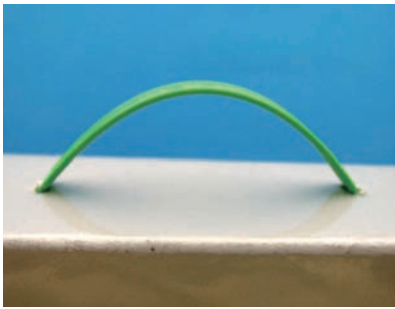

- Material: Nylon 66 (UL)
- Flame Class: 94V-2/94V-0
- Color: Natural/Black/Green
- Unit: mm

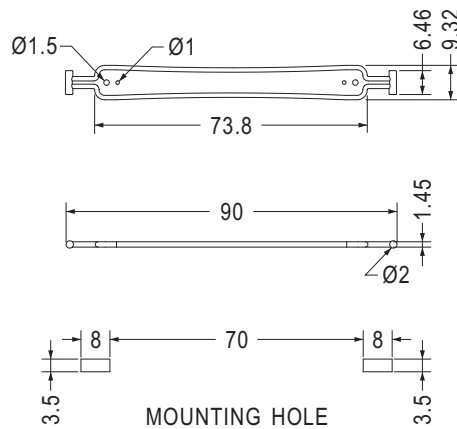

Part No.	Package
HAND-7	500



- Material: PE
- Color: Natural/Black
- Unit: mm

用途：用於包裝盒上，HAND-1配合 HAND-2或HAND-65使用，組裝方便。

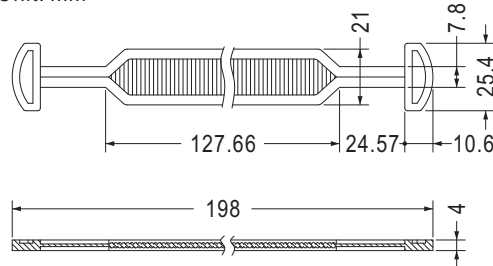

Part No.	Package
HAND-1	100

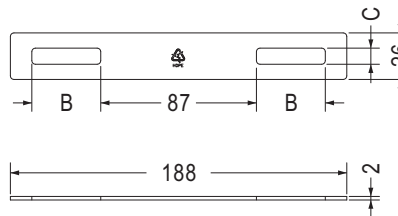
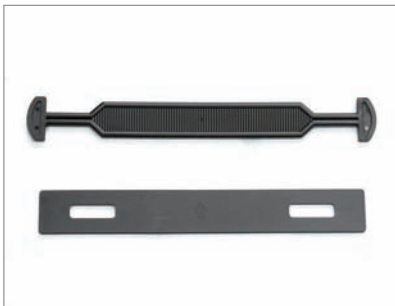

Part No.	B	C	Package
HAND-2	38.5	9.0	100
HAND-65	26.2	8.4	



- Material: PE
- Color: Black
- Unit: mm

用途：用於包裝盒上，HAND-12配合 HAND-13使用，組裝方便。

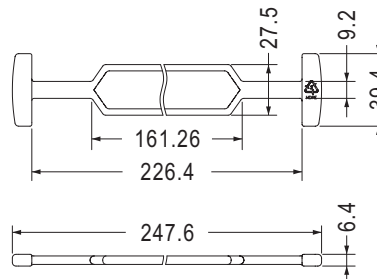

Part No.	Package
HAND-12	100

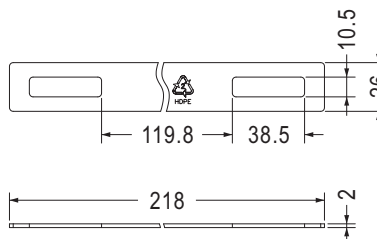

Part No.	Package
HAND-13	100

把手 HANDLE

用途：用於包裝盒上，HAND-23A配合
HAND-23B使用，組裝方便。

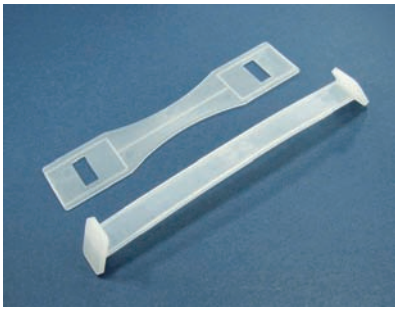

- Material: PE/PP
- Color: Natural
- Unit: mm

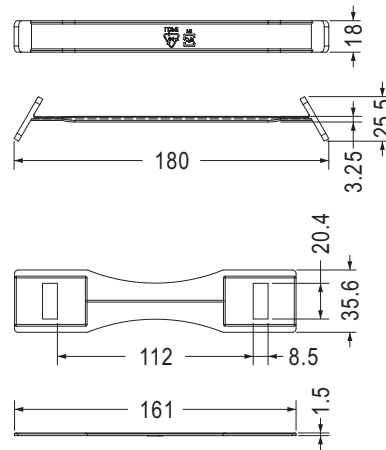

Part No.	Package
HAND-23A	100

Part No.	Package
HAND-23B	100



- Material: PE
- Color: Natural
- Unit: mm

用途：用於包裝盒上，HAND-14A配合
HAND-14B使用，組裝方便。

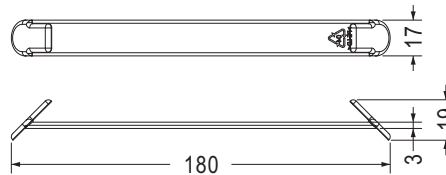

Part No.	Package
HAND-14A	100

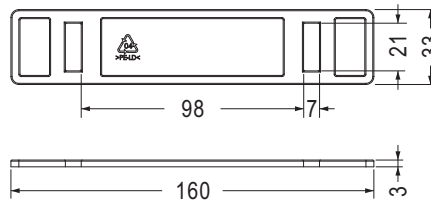
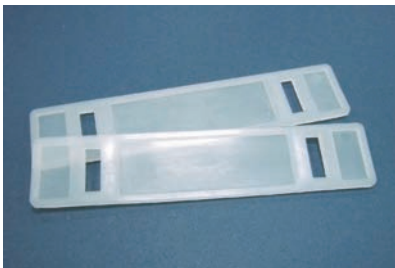

Part No.	Package
HAND-14B	100



- Material: PE
- Color: Natural
- Unit: mm

用途：用於包裝盒上，HAND-75A配合
HAND-75B使用，組裝方便。

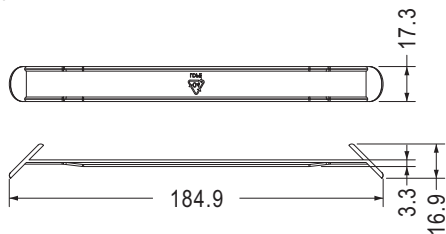

Part No.	Package
HAND-75A	100

- Material: PP
- Color: Natural
- Unit: mm

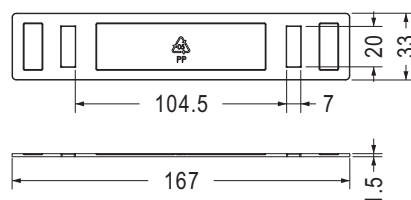

Part No.	Package
HAND-75B	100

把手 HANDLE

用途：用於包裝盒上，HANDN26A配合HAND-26B使用，組裝方便。



- Material: PE
- Color: Natural
- Unit: mm

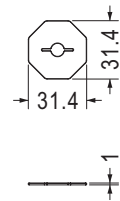
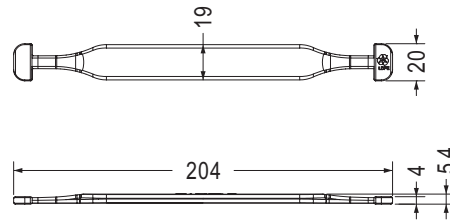

Part No.	Package
HANDN26A	100

Part No.	Package
HAND-26B	100



- Material: Nylon 66 (UL)
- Flame Class: 94V-2/94V-0
- Color: Natural/Black
- Unit: mm

用途：做為把手使用。

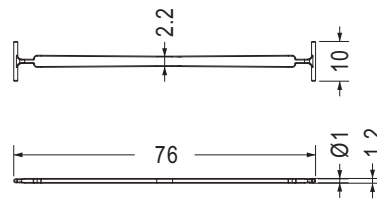

Part No.	Package
HAND-40	500



- Material: Nylon 66 (UL)
- Flame Class: 94HB
- Color: Black
- Unit: mm

用途：用於大型機殼之拉拔，耐負重。

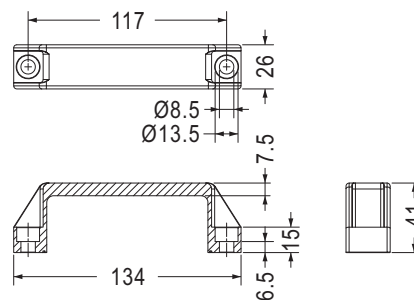

Part No.	Package
HAND-70	100



- Material: PC+ABS (UL)
- Flame Class: 94V-0
- Color: Black
- Unit: mm

用途：用於機殼之拉拔。

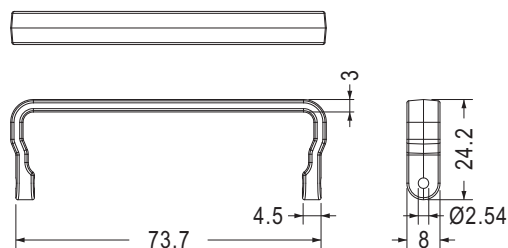

Part No.	Package
HAND-73	100

把手 HANDLE

用途：用於機殼之拉拔。



- Material: PC+ABS (UL)
- Flame Class: 94V-2/94V-0
- Color: Black
- Unit: mm

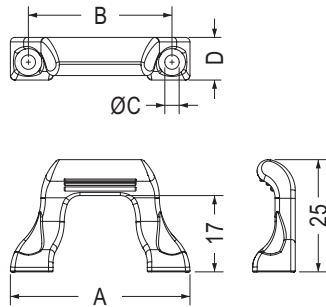

Part No.	A	B	C	D	Package
HAND-25	40.0	32.0	3.2	9.5	250
HAND-25-1	40.0	32.0	4.1	9.5	
HAND-38	38.0	30.0	3.2	9.5	
HAND-41	38.0	30.0	4.0	9.5	
HAND-41L	38.3	30.0	4.05	9.8	
HAND-47	40.0	32.0	4.2	9.5	

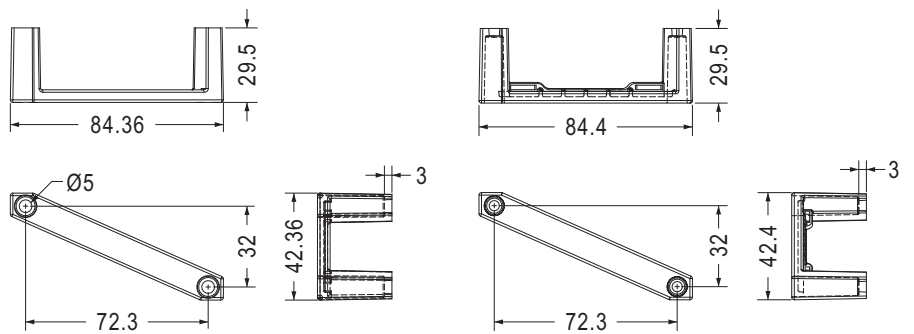

Part No.	Package
HAND-27	100

Part No.	Package
HAND-34	250

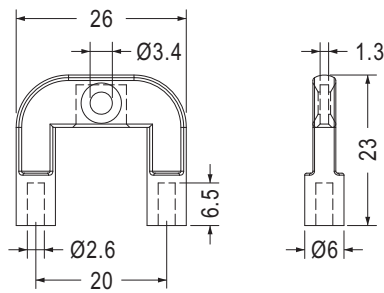

- Material: Nylon 66 (UL)
- Flame Class: 94V-2/94V-0
- Color: Black/Blue

Part No.	Package
HAND-87	1000

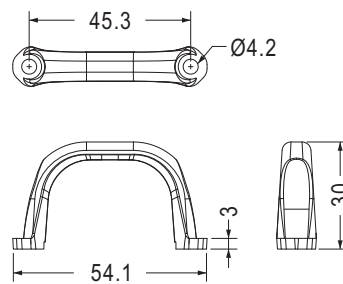

Part No.	Package
HAND-53	100

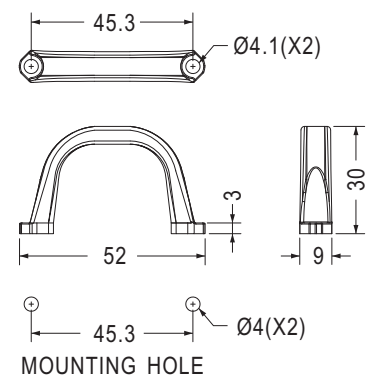

Part No.	Package
HANU-92	250

把手 HANDLE

用途：用於機殼之拉拔。

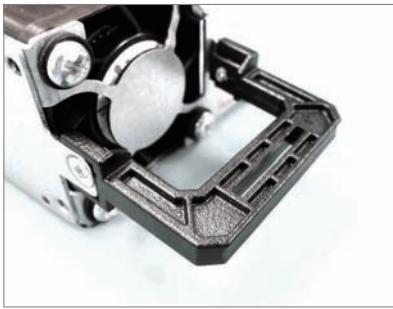

- Material: PC (UL)
- Flame Class: 94V-2/94V-0
- Color: Black
- Unit: mm

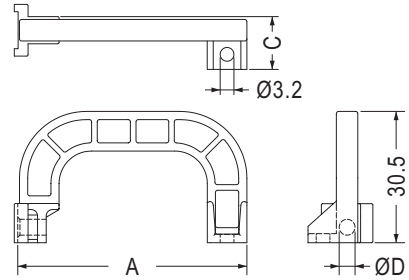

Part No.	A	C	D	Package
HAND-10	53.4	12.5	3.7	250
HAND-74	51.5	11.6	3.6	

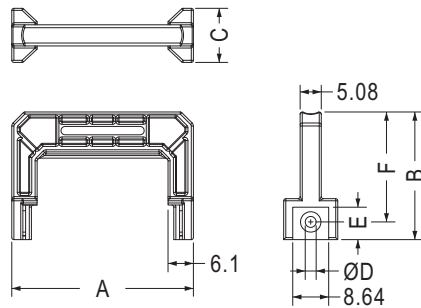

Part No.	A	B	C	D	E	F	Package
HAND-51	43.63	29.97	11.68	2.62	7.4	26.41	250
HAND-51L	43.63	30.67	13.0	2.62	7.8	26.41	
HAND-54	41.63	29.98	11.68	2.62	7.4	26.42	
HAND-55	34.59	29.98	11.68	2.6	7.1	26.42	

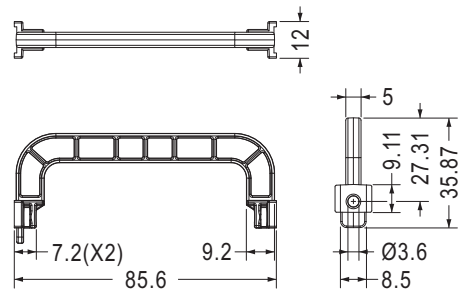

Part No.	Package
HAND-82	100

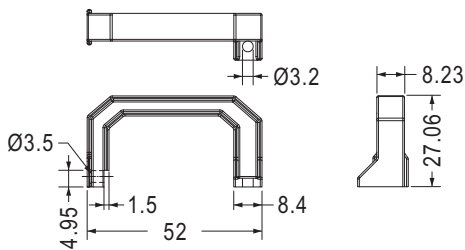

Part No.	Package
HAND-79	250

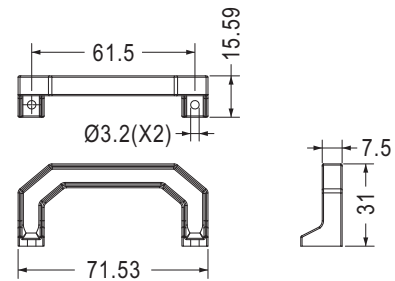

Part No.	Package
HAND-80-1	250

- Material: PC+ABS (UL)
- Flame Class: 94V-0
- Color: Black
- Unit: mm

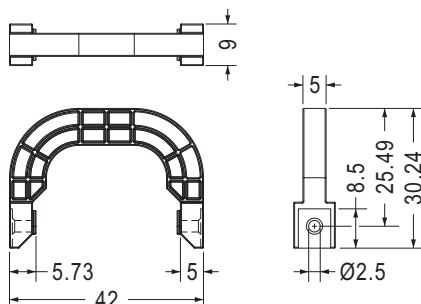

Part No.	Package
HAND-50	250

- Material: PC+ABS (UL)
- Flame Class: 94V-0
- Color: Juniper Blue/Juniper Orange
- Unit: mm

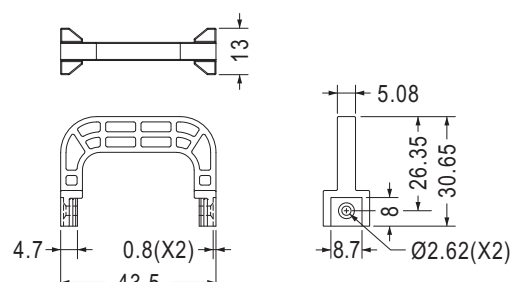

Part No.	Package
HAND-99	100

把手 HANDLE

用途：用於機殼之拉拔。



- Body Material: PC+ABS (UL)
- Metal Material: Zinc Plated SPCC
- Body Flame Class: 94V-2/94V-0
- Color: Black
- Unit: mm

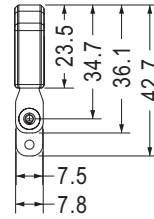
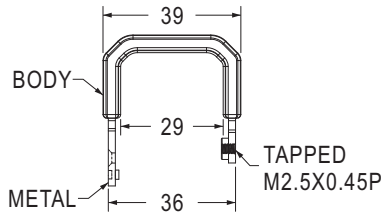

Part No.	Package
HAND-29	250

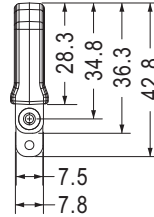
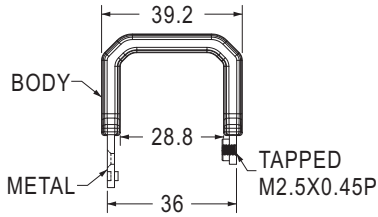

Part No.	Package
HAND-84	250



- Body Material: Silicon Rubber
- Metal Material: Zinc Plated SPCC
- Color: Black
- Unit: mm

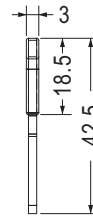
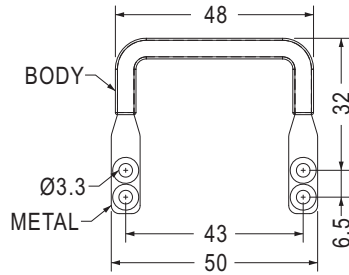

Part No.	Package
HAND-71	500



- Body Material: PC+ABS (UL)
- Metal Material: Zinc Plated SPCC
- Body Flame Class: 94V-2/94V-0
- Color: Black
- Unit: mm

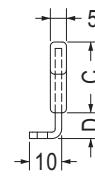
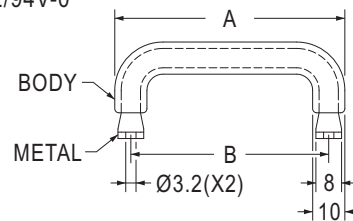

Part No.	A	B	C	D	Package
HAND-30	71.5	61.5	22.0	8.0	250
HAND-31	51.6	41.6	21.0	9.0	



- Body Material: PC+ABS (UL)
- Metal Material: SGCC
- Body Flame Class: 94V-0
- Color: Black
- Unit: mm

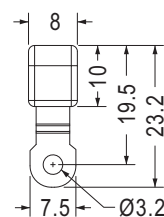
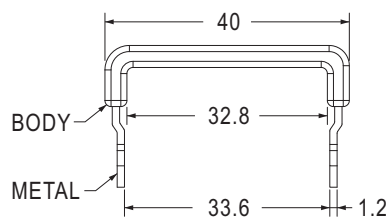

Part No.	Package
HANU-83	1000

把手 HANDLE

用途：用於機殼之拉拔。



- Material: Nylon 66 (UL)
- Flame Class: 94V-2/94V-0
- Color: Black
- Unit: mm

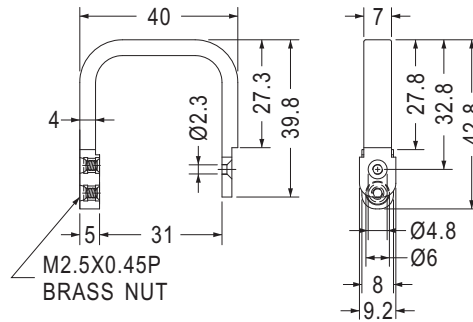

Part No.	Package
HANU-34	100



- Material: PC+ABS (UL)
- Flame Class: 94V-0
- Color: Black
- Unit: mm

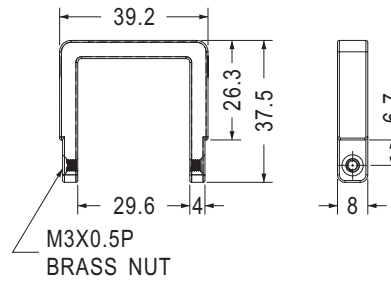

Part No.	Package
HANU-139	250

5

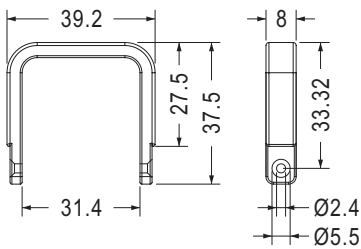

Part No.	Package
HANU-71	250

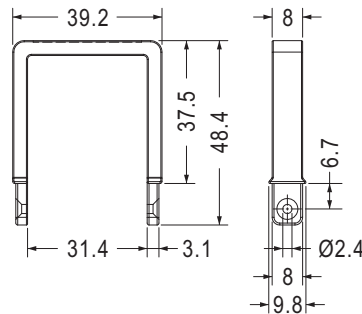

Part No.	Package
HANU-138	250

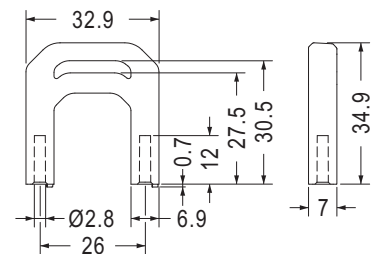

Part No.	Package
HANU-27U	250



- Material: Nylon 66 (UL)
- Flame Class: 94V-0
- Color: Black
- Unit: mm

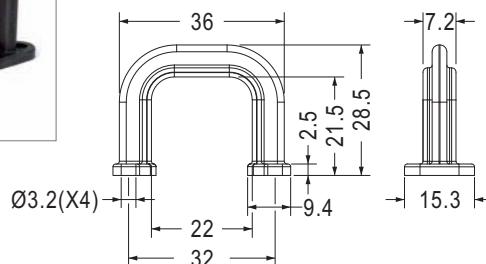

Part No.	Package
HANU-73	250

- Material: PC+ABS (UL)
- Flame Class: 94V-0
- Color: Gray
- Unit: mm

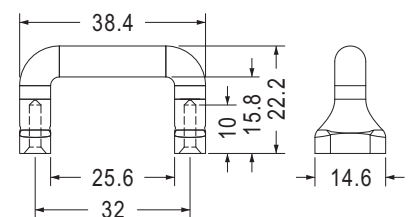

Part No.	Package
HANU-82	250

把手 HANDLE

用途：用於機殼之拉拔。



- Material: PC+ABS (UL)
- Flame Class: 94V-0
- Color: Black
- Unit: mm

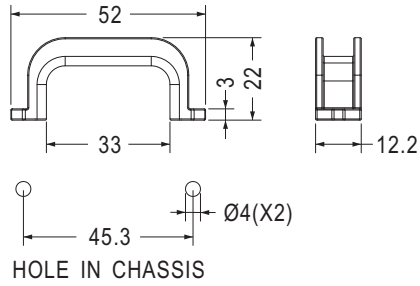

Part No.	Package
HANU-91	250



- Material: Nylon 66 (UL)/PC+ABS (UL)/PC (UL)
- Flame Class: 94HB/94V-2/94V-0
- Color: Black
- Unit: mm

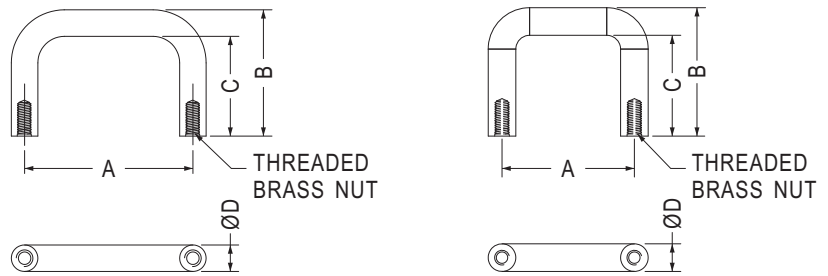

[HANU-130, HANU-154, HANU-155]

Part No.	A	B	C	D	Thread	Package
HANU-40	40.0	30.0	23.7	6.3	M3X0.5P	250
HANU-48	48.0	32.0	25.7	6.3		
HANU-51	51.0	32.0	25.7	6.3		
HANU-70-1	51.0	38.7	31.7	7.0		
HANU-70	51.0	38.7	31.7	7.0	6-32 UNC	200
HANU-72	51.5	45.0	38.0	7.3	M3X0.5P	250
HANU-76-632	32.0	22.5	15.5	7.0		
HANU-76	32.0	22.5	15.5	7.0		
HANU-77	32.0	29.3	23.0	6.3		
HANU-97	32.0	23.3	17.0	6.3	M3X0.5P	250
HANU-107	32.0	40.0	33.0	7.0		

Part No.	A	B	C	D	Thread	Package
HANU-109	29.0	40.0	33.0	7.0	M3X0.5P	40
HANU-111	40.0	30.0	24.0	6.0		250
HANU-115	54.0	29.9	23.0	6.9		100
HANU-123	48.0	26.0	19.7	6.3	M3X0.5P	250
HANU-125	26.0	25.0	19.5	5.5		
HANU-126	45.3	22.5	17.0	5.5		
HANU-128	25.0	28.5	22.2	6.3		
HANU-130	30.2	29.3	23.0	6.3		
HANU-154	31.3	29.0	22.6	6.4		
HANU-155	29.9	49.0	42.0	7.0		



- Material: PC+ABS (UL)/PC (UL)
- Flame Class: 94V-2/94V-0
- Color: Black
- Unit: mm

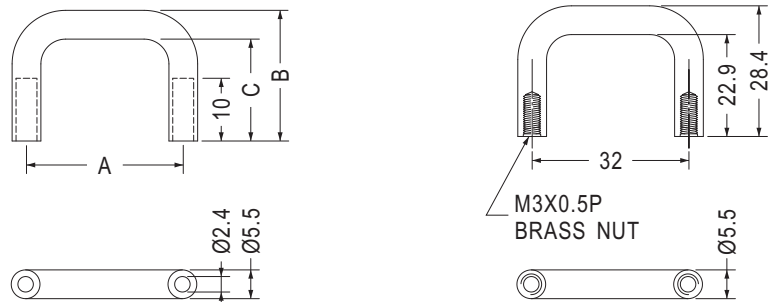

Part No.	A	B	C	Package
HANU-30PN	30.0	25.0	19.5	250
HANU-32VB	32.0	28.4	22.9	

Part No.	Package
HANU-32PVB	250

把手 HANDLE

用途：用於機殼之拉拔。



- Material: PC+ABS (UL)
- Flame Class: 94V-0
- Color: Black
- Unit: mm
- Patented (專利品)

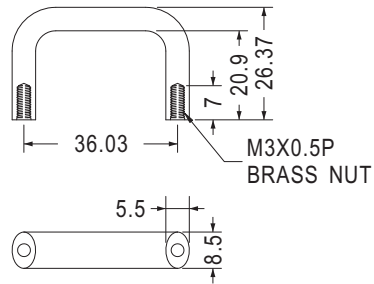

Part No.	Package
HANU-142	250



- Body Material: PC+ABS (UL)
- Metal Material: Steel Zinc Plated
- Body Flame Class: 94V-0
- Color: Black
- Unit: mm

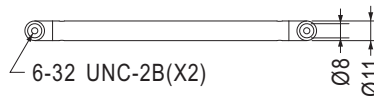
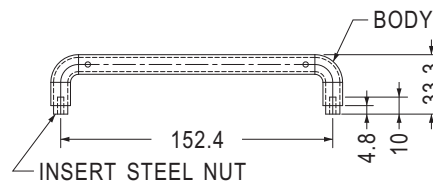

Part No.	Package
HANU-141	100

5



- Material: PC+ABS (UL)
- Flame Class: 94V-0
- Color: Gray
- Unit: mm

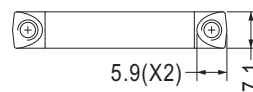
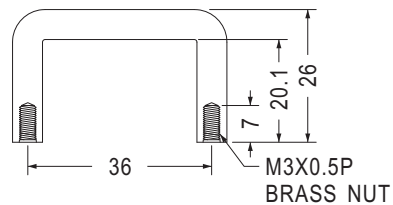

Part No.	Package
HANU-137	250



- Material: PC+ABS (UL)
- Flame Class: 94V-0
- Color: Black
- Unit: mm

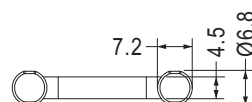
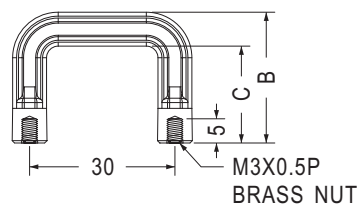

Part No.	B	C	Package
HANU-108	27.0	20.0	250
HANU-114	34.0	27.0	

把手 HANDLE

用途：用於機殼之拉拔。



- Material: PC+ABS (UL)
- Flame Class: 94V-0
- Color: Black
- Unit: mm

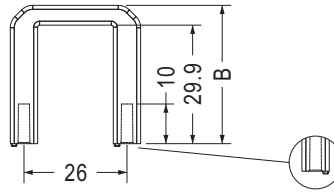

【 HANU-102-1 】

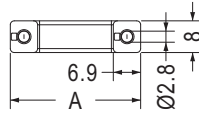

Part No.	A	B	Package
HANU-102	32.9	34.9	250
HANU-102-1	33.0	35.0	



- Material: PC+ABS (UL)
- Flame Class: 94V-0
- Color: Black
- Unit: mm

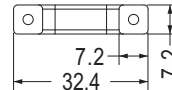
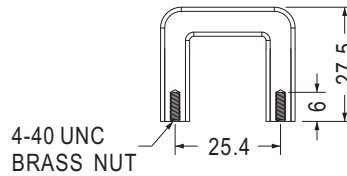

Part No.	Package
HANU-103	250



- Material: PC (UL)
- Flame Class: 94V-2/94V-0
- Color: Transparent
- Unit: mm

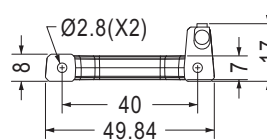
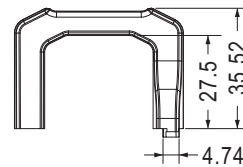

Part No.	Package
HANU-80	200

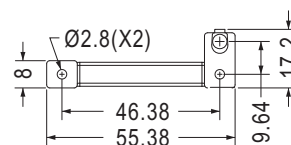
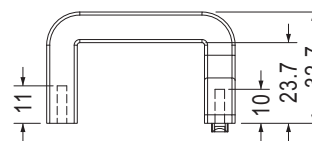

Part No.	Package
HANU-117	100

把手 HANDLE

用途：用於機殼之拉拔，不使用時可折疊，大量節省空間。



- Body Material: Nylon 66 (UL)+GF
- Flame Class: 94V-0
- Screw Material: Brass(Nickel Plated)
- Color: Black
- Unit: mm

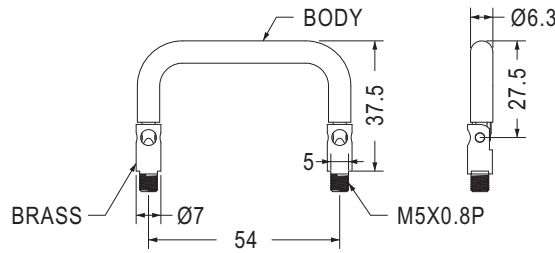

Part No.	Package
HANUL-2F	100

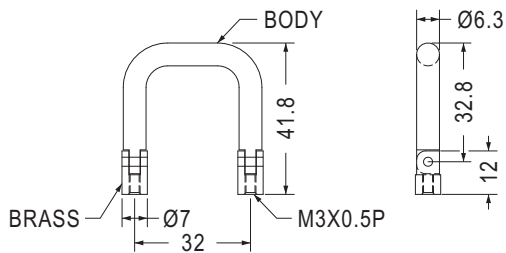

Part No.	Package
HANUL-3NF	100

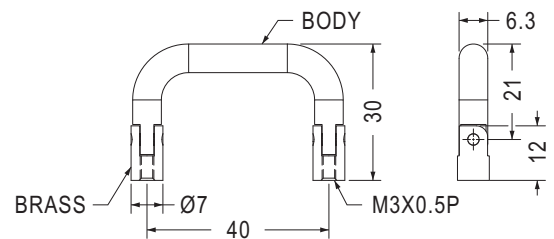

Part No.	Package
HANUL-16F	100

5



- Material: PC (UL)
- Flame Class: 94V-2
- Color: Black
- Unit: mm

用途：用於機殼之拉拔。

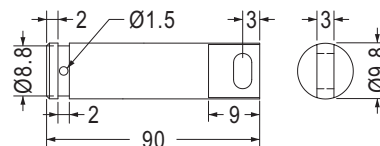

Part No.	Package
HANI-90	100



- Material: PC+ABS (UL)
- Flame Class: 94V-0
- Color: Black
- Unit: mm

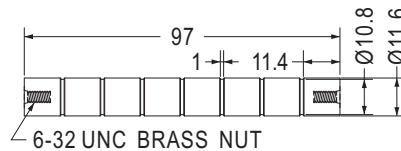

Part No.	Package
HANI-96	100

- Material: PC (UL)
- Flame Class: 94V-0
- Color: Black
- Unit: mm

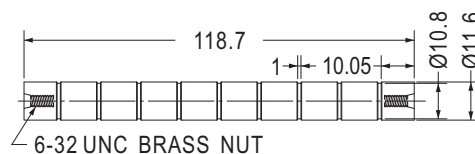

Part No.	Package
HANI-119	50

拉柄 LATCH CAP

用途：用於機殼之拉拔。



裝配件尺寸，僅供參考
Assembly parts are for reference only.

- Material: TPE (UL)
- Flame Class: 94V-0
- Color: Black
- Unit: mm

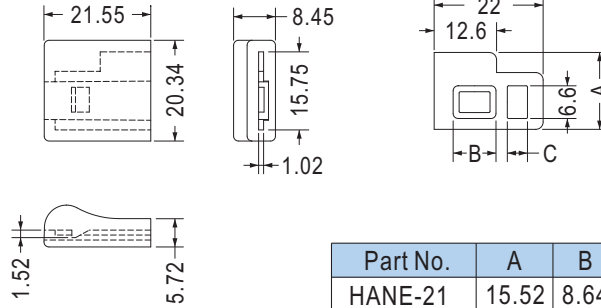

Assembly Part

Part No.	A	B	C	Package
HANE-21	15.52	8.64	4.06	250
HANE-21L	15.2	9.2	3.9	



裝配件尺寸，僅供參考
Assembly parts are for reference only.

- Material: Santopren
- Color: Black
- Unit: mm

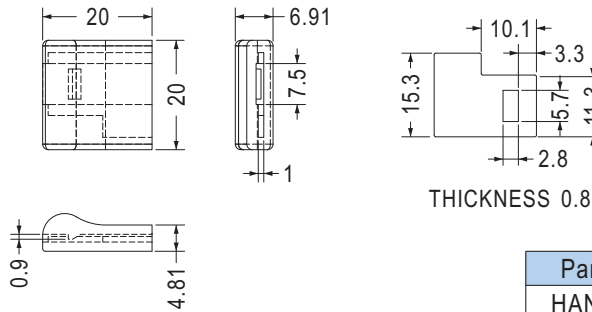

Assembly Part

THICKNESS 0.8

Part No.	Package
HANE-35	250

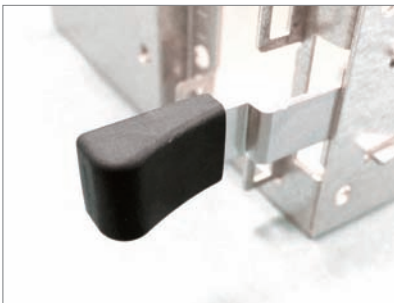

裝配件尺寸，僅供參考
Assembly parts are for reference only.

- Material: TPR
- Color: Black
- Unit: mm

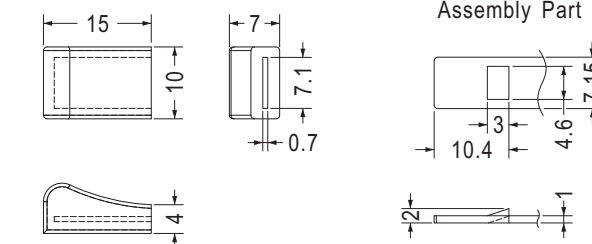

Assembly Part

Part No.	Package
HANE-59	500

拉柄 LATCH CAP

用途：用於機殼之拉拔。



裝配件尺寸，僅供參考
Assembly parts are for reference only.

- Material: PC+ABS (UL)
- Flame Class: 94V-2/94V-0
- Color: Black
- Unit: mm

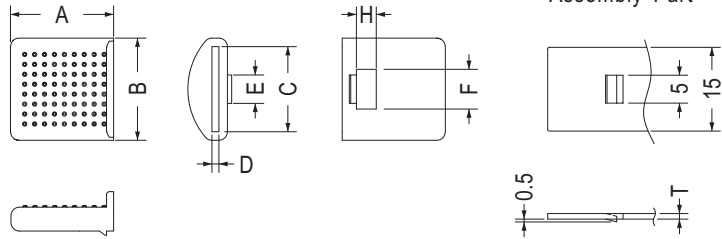

Part No.	A	B	C	D	E	F	H	T	Package
HANE18	18.47	18.29	15.24	1.24	5.08	7.11	3.56	1.0	250
HANE18LV	18.47	18.29	15.24	1.4	5.08	7.11	3.56	1.2	
HANE29	18.5	18.3	15.1	1.2	5.1	7.0	3.2	1.0	



裝配件尺寸，僅供參考
Assembly parts are for reference only.

- Material: Nylon 66 (UL)
- Flame Class: 94V-2/94V-0
- Color: Black
- Unit: mm

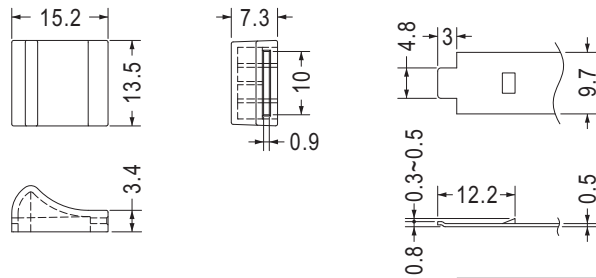

Part No.	Package
HANE-77	1000

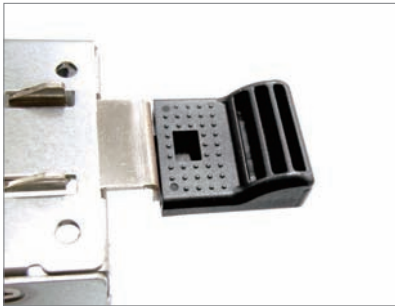

裝配件尺寸，僅供參考
Assembly parts are for reference only.

- Material: PC+ABS (UL)
- Flame Class: 94V-2/94V-0
- Color: Black
- Unit: mm

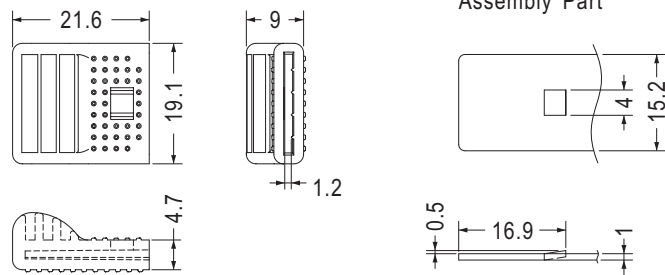

Part No.	Package
HANE-24	250

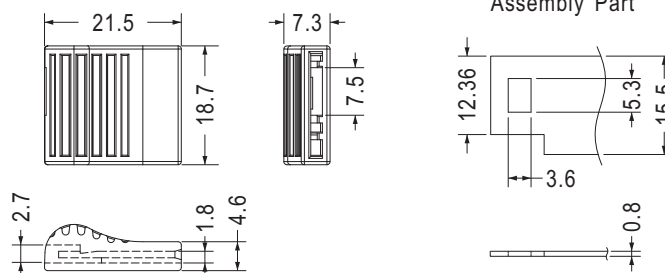

Part No.	Package
HANE-40	1000

- Color: Black/Green

拉柄 LATCH CAP

用途：用於機殼之拉拔。

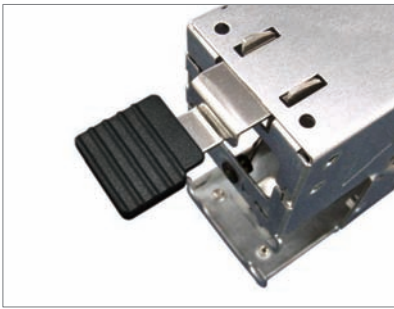

裝配件尺寸，僅供參考
Assembly parts are for reference only.

- Material: PC+ABS (UL)
- Flame Class: 94V-2/94V-0
- Color: Black
- Unit: mm

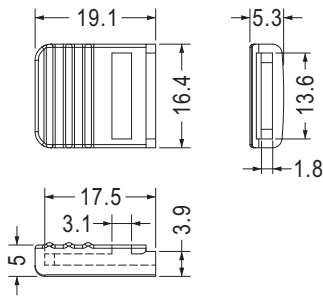

Assembly Part

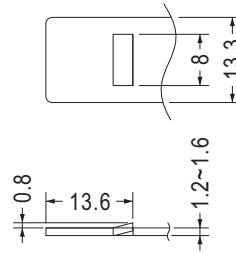

Part No.	Package
HANE-32	1000

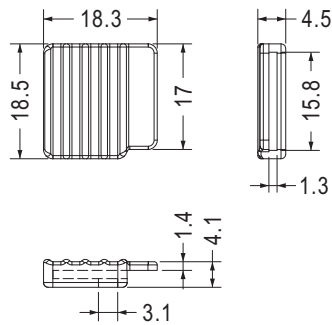

Assembly Part

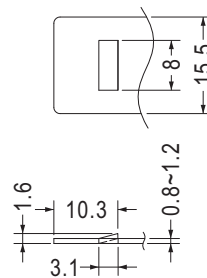

Part No.	Package
HANE-33	1000

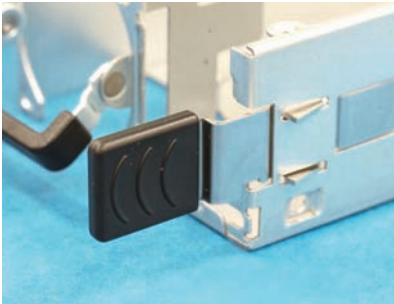

裝配件尺寸，僅供參考
Assembly parts are for reference only.

- Material: PC+ABS (UL)
- Flame Class: 94V-2/94V-0
- Color: Black/Blue/Purple/Green
- Unit: mm

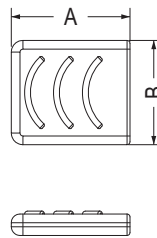

Assembly Part

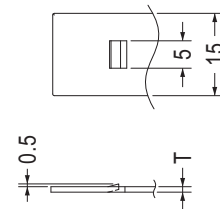

Part No.	A	B	C	D	T	Package
HANE-36	20.5	18.0	4.0	1.0	0.8~1.0	1000
HANE-48	20.5	18.0	4.0	1.2	1.2	
HANE-55	20.5	18.0	3.7	1.0	0.8~1.0	
HANE-69	20.7	18.2	4.0	1.0	1.0	



裝配件尺寸，僅供參考
Assembly parts are for reference only.

- Material: PC (UL)
- Flame Class: 94V-0
- Color: Red/Blue
- Unit: mm

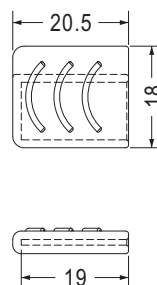

Assembly Part

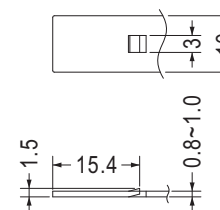

Part No.	Package
HANE-113	1000

拉柄 LATCH CAP

用途：用於機殼之拉拔。

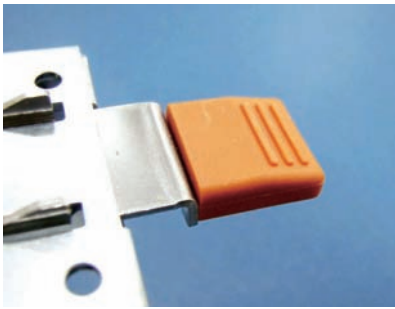

裝配件尺寸，僅供參考
Assembly parts are for reference only.

- Material: TPE
- Color: Black/Orange
- Unit: mm

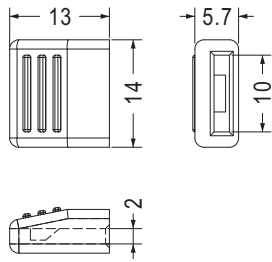

Assembly Part

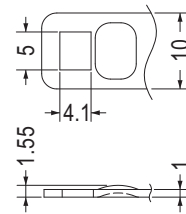

Part No.	Package
HANE-23	1000

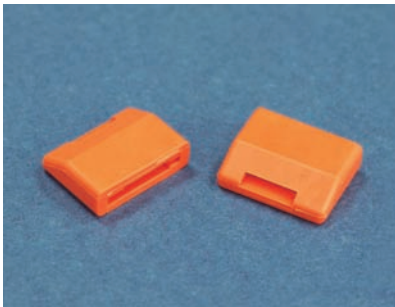

裝配件尺寸，僅供參考
Assembly parts are for reference only.

- Material: TPE (UL)
- Flame Class: 94V-0
- Color: Black/Orange
- Unit: mm

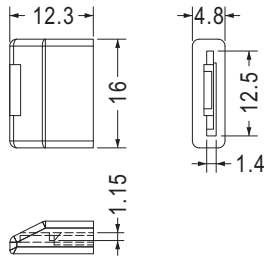

Assembly Part

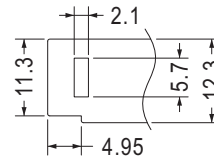

THICKNESS 0.8

Part No.	Package
HANE-37	1000



裝配件尺寸，僅供參考
Assembly parts are for reference only.

- Material: TPE (UL)
- Flame Class: 94V-0
- Color: Black/Orange
- Unit: mm

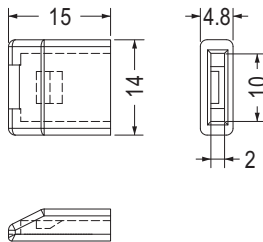

Assembly Part

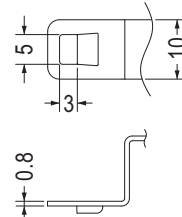

Part No.	Package
HANE-75	1000



裝配件尺寸，僅供參考
Assembly parts are for reference only.

- Material: PP (UL)
- Flame Class: 94V-0
- Color: Blue
- Unit: mm

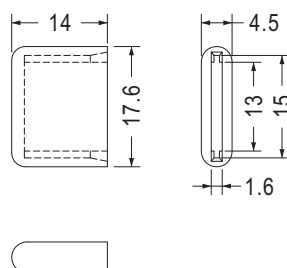

Assembly Part

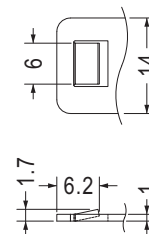

Part No.	Package
HANE-111	1000

拉柄 LATCH CAP

用途：用於機殼之拉拔。

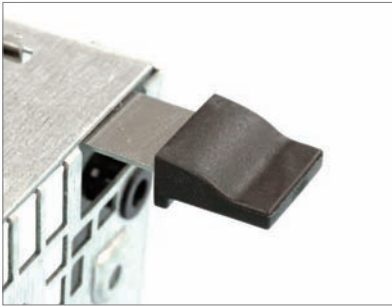

裝配件尺寸，僅供參考
Assembly parts are for reference only.

- Material: Nylon 66 (UL)
- Flame Class: 94V-2/94V-0
- Color: Black
- Unit: mm

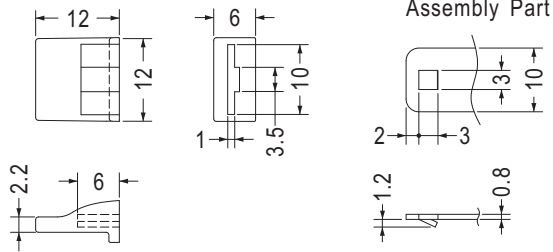

Part No.	Package
HANE-26	1000

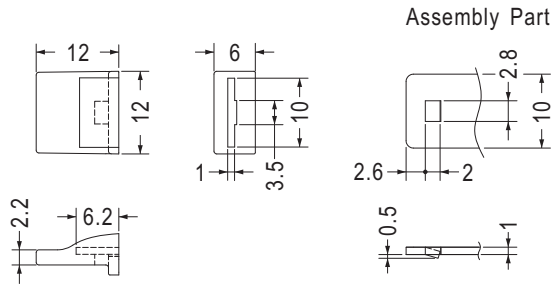

Part No.	Package
HANE-38	1000

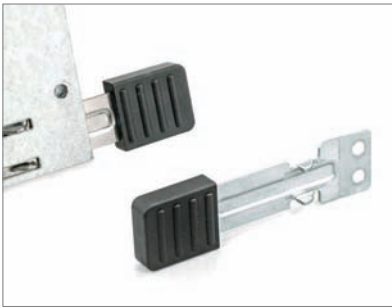

裝配件尺寸，僅供參考
Assembly parts are for reference only.

- Material: PC+ABS (UL)
- Flame Class: 94V-0
- Color: Black/Blue
- Unit: mm

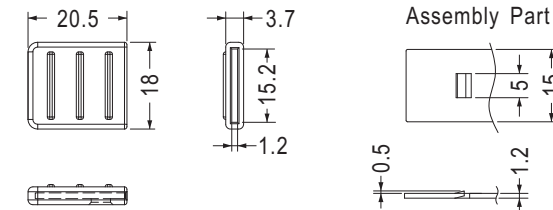

Part No.	Package
HANE-74	1000

- Material: Nylon 66 (UL)
- Flame Class: 94V-2/94V-0
- Color: Black
- Unit: mm

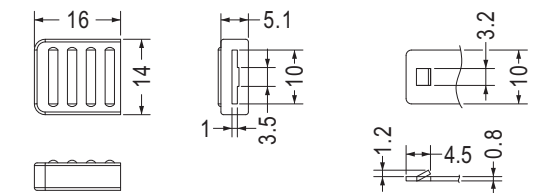

Part No.	Package
HANE-49	1000



裝配件尺寸，僅供參考
Assembly parts are for reference only.

- Material: PC+ABS (UL)
- Flame Class: 94V-0
- Color: Black
- Unit: mm

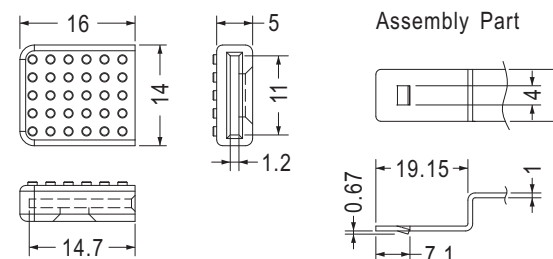

Part No.	Package
HANE-97	1000

拉柄 LATCH CAP

用途：用於機殼之拉拔。

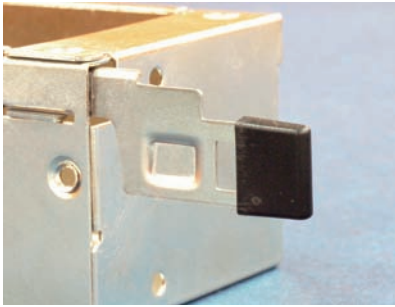

裝配件尺寸，僅供參考
Assembly parts are for reference only.

- Material: PC+ABS
- Color: Black
- Unit: mm

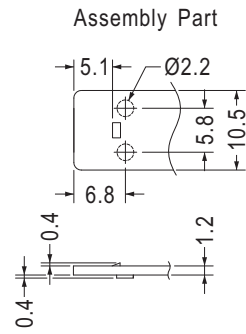
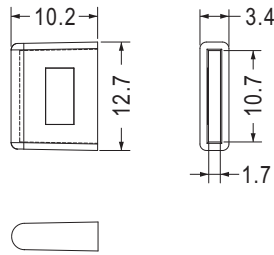

Part No.	Package
HANE-27	1000

- Material: Nylon 66 (UL)
- Flame Class: 94V-2/94V-0
- Color: Black
- Unit: mm

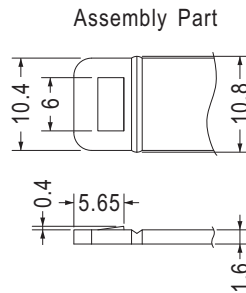
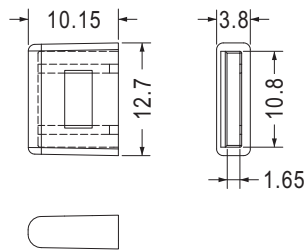

Part No.	Package
HANE-72	1000



裝配件尺寸，僅供參考
Assembly parts are for reference only.

- Material: PC+ABS (UL)
- Flame Class: 94V-2
- Color: Black/Gray
- Unit: mm

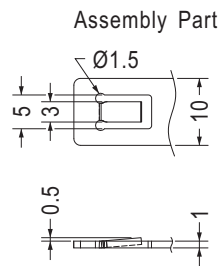
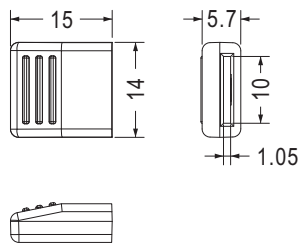

Part No.	Package
HANE-58	1000



裝配件尺寸，僅供參考
Assembly parts are for reference only.

- Material: PC+ABS (UL)
- Flame Class: 94V-0
- Color: Black
- Unit: mm

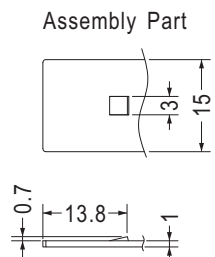
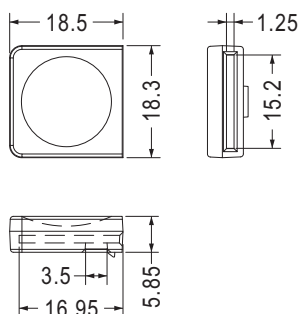

Part No.	Package
HANE-98	1000

拉柄 LATCH CAP

用途：用於機殼之拉拔。



裝配件尺寸，僅供參考
Assembly parts are for reference only.

- Material: PC (UL)/ABS
- Flame Class: 94V-2/94V-0
- Color: Black/Orange
- Unit: mm

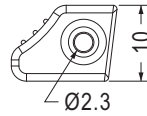
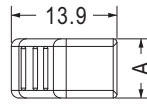

Assembly Part

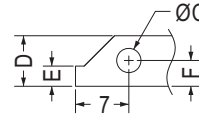

THICKNESS: T

Part No.	A	C	D	E	F	T	Package
HANE-46	7.8	3.2	6.6	2.6	3.4	0.6	1000
HANE-76	5.0	4.0	7.0	3.0	3.5	0.7	
HANE-108	5.2	4.0	7.0	3.0	3.5	0.8	



裝配件尺寸，僅供參考
Assembly parts are for reference only.

- Material: TPV
- Color: Black
- Unit: mm

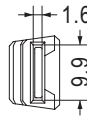
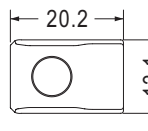

Assembly Part

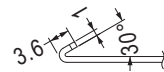
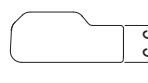
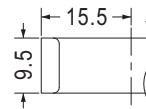

Part No.	Package
HANE-22	250

- Material: PC+ABS (UL)
- Flame Class: 94V-0
- Color: Black
- Unit: mm

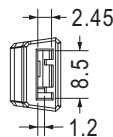
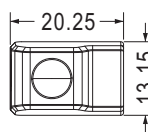

Assembly Part

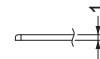
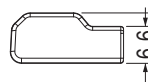
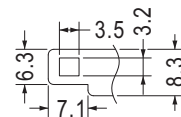

Part No.	Package
HANE-41	250



裝配件尺寸，僅供參考
Assembly parts are for reference only.

- Material: PC+ABS (UL)
- Flame Class: 94V-2/94V-0
- Color: Black/Orange
- Unit: mm

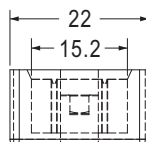
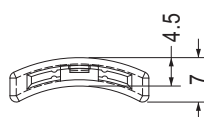

Assembly Part

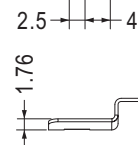
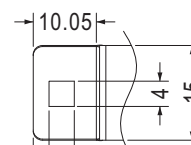

Part No.	Package
HANE-34	1000

拉柄 LATCH CAP

用途：用於機殼之拉拔。



裝配件尺寸，僅供參考
Assembly parts are for reference only.

- Material: Nylon 66 (UL)
- Flame Class: 94V-2/94V-0
- Color: Black
- Unit: mm

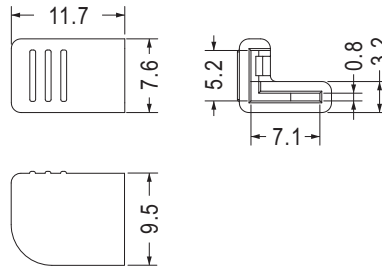

Assembly Part

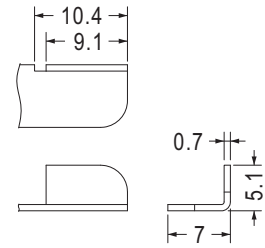

Part No.	Package
HANE-30	1000



裝配件尺寸，僅供參考
Assembly parts are for reference only.

- Material: Nylon 66 (UL)
- Flame Class: 94V-2/94V-0
- Color: Black
- Unit: mm

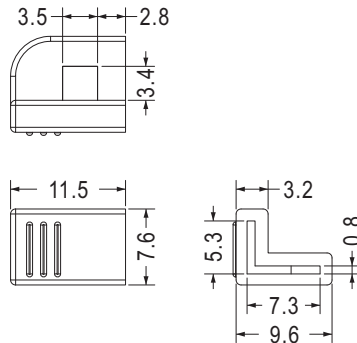

Assembly Part

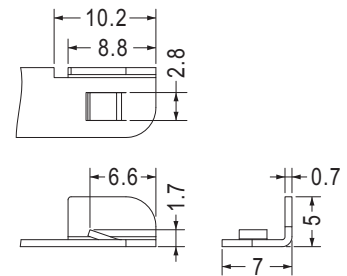

Part No.	Package
HANE-103	1000



裝配件尺寸，僅供參考
Assembly parts are for reference only.

- Material: Nylon 66 (UL)
- Flame Class: 94V-2/94V-0
- Color: Black
- Unit: mm
- Patented (專利品)

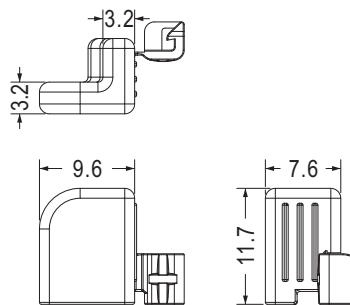

Assembly Part

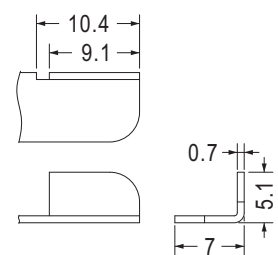

Part No.	Package
HANE-86	1000

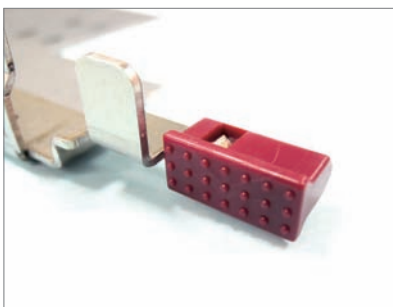

- Material: PC+ABS (UL)
- Flame Class: 94V-2/94V-0
- Color: Hot Plug Red
- Unit: mm

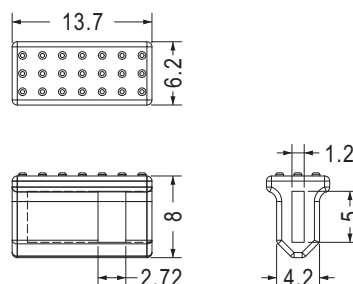

Assembly Part

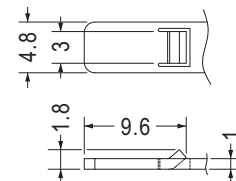

Part No.	Package
HANE-53	1000

拉柄 LATCH CAP

用途：用於機殼之拉拔。

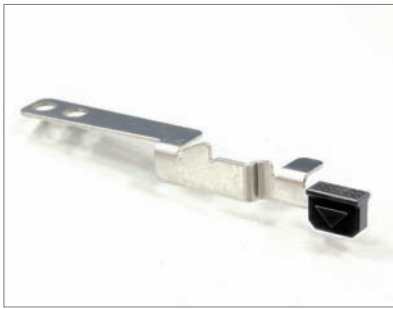

- Material: PC+ABS (UL)
- Flame Class: 94V-0
- Color: Black
- Unit: mm

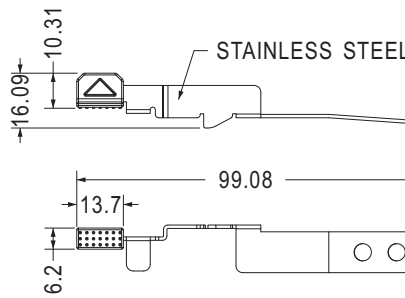

Part No.	Package
HANE-64	200

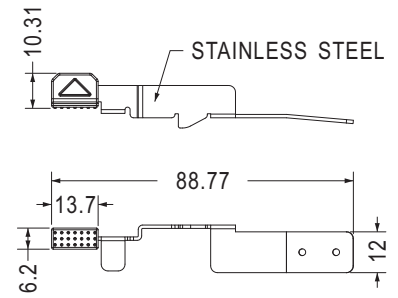

- Color: Red

Part No.	Package
HANE-104	200

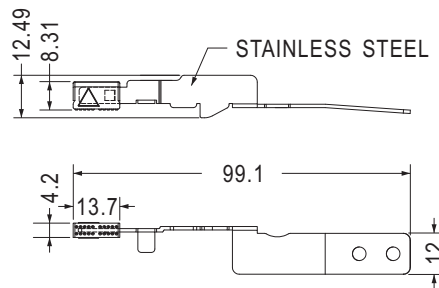
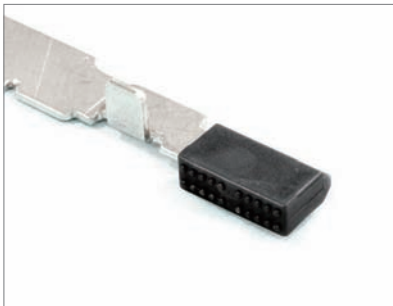

- Color: Black/Red

Part No.	Package
HANE-67	200

把手 HANDLE

用途：用於PC板或機殼之拉拔。

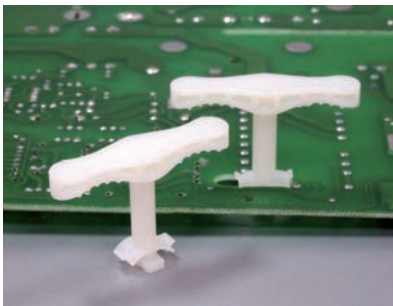

- Material: Nylon 66 (UL)
- Flame Class: 94V-2/94V-0
- Color: Natural/Black
- Unit: mm
- Patented (專利品)

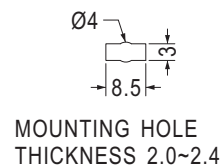
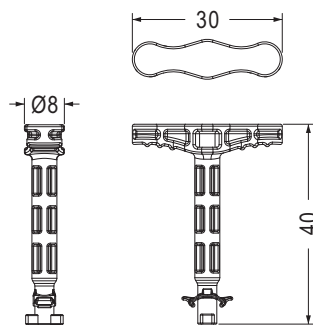

Part No.	Package
HANT-1	1000

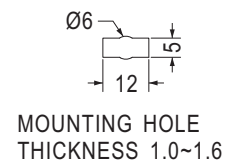
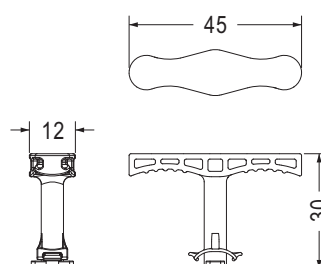

Part No.	Package
HANT-2	1000

外箱扣 BOX HANDLE

用途：用於包裝盒上，組裝方便。



- Material: PP
- Color: Natural/Black
- Unit: mm

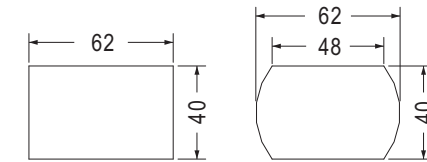
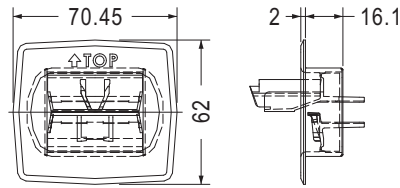

MOUNTING HOLE MOUNTING HOLE

裝配孔以上兩者皆可

Part No.	Package
CABOX-1	50

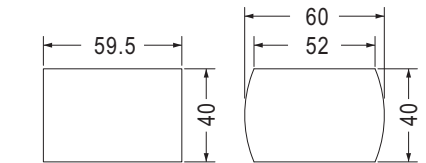
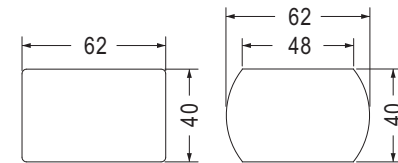
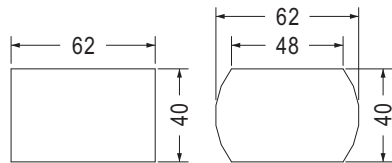
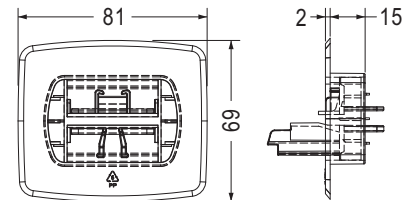
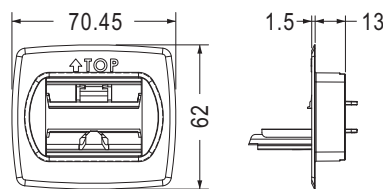
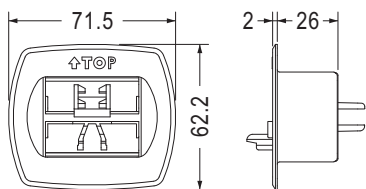

MOUNTING HOLE MOUNTING HOLE

裝配孔以上兩者皆可

MOUNTING HOLE MOUNTING HOLE

裝配孔以上兩者皆可

MOUNTING HOLE MOUNTING HOLE

裝配孔以上兩者皆可

Part No.	Package
CABOX-3	50

Part No.	Package
CABOX-5	50

Part No.	Package
CABOX-6	40

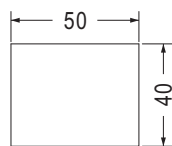
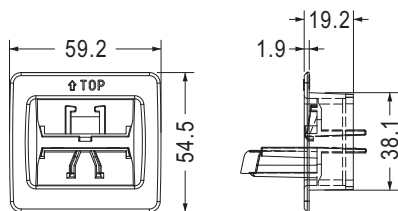

MOUNTING HOLE

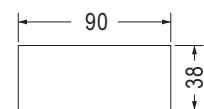
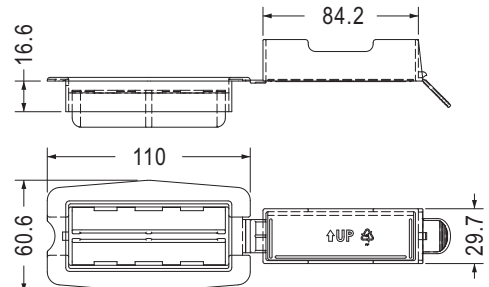

MOUNTING HOLE

Part No.	Package
CABOX-7	50

Part No.	Package
CABOX-2	25

打包扣 PACKING FASTENER

用途：用於打包繩束線用，整齊美觀方便拆卸。



- Material: PP
- Color: Natural
- Unit: mm

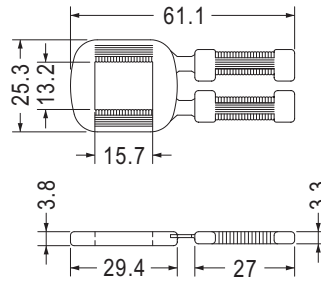

Part No.	Package
CTBX-1	250

外箱護腳墊 BOX PLASTIC FOOT

用途：用於外箱打包機，避免外箱打凹變形。



- Material: PP
- Color: Black
- Unit: mm

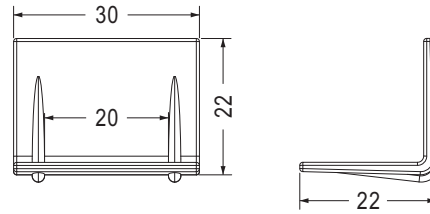

Part No.	Package
CTBXA-1	1000

護線套 MOVEABLE BUSHING

用途：用於電線出線口，防止電線機殼刮傷。



- Material: Nylon 6
- Color: Natural
- Unit: mm

- Material: Nylon 6 (UL)
- Flame Class: 94V-2

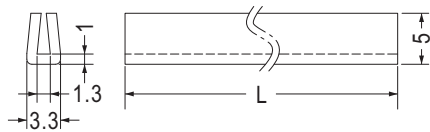

CHASSIS THICKNESS 0.8~1.2

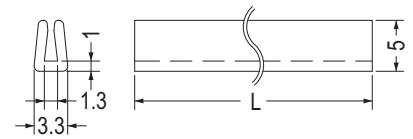

CHASSIS THICKNESS 1.0~1.2

Part No.	L	Package
KGA13-185	185.0	500
KGA13-260	260.0	

Part No.	L	Package
KGC-013-45	45.0	500
KGC-013-70	70.0	



- Material: Nylon 66 (UL)
- Flame Class: 94V-2/94V-0
- Color: Natural
- Unit: mm

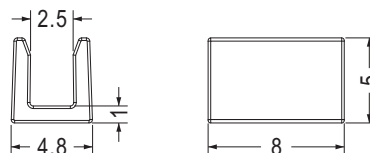

Part No.	Package
KGC-025-8	500

活用護線套 MOVEABLE BUSHING

用途：用於電線出線口，防止電線機殼刮傷。

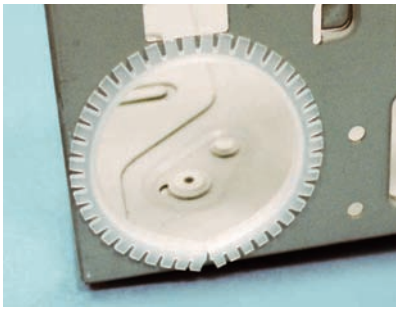

- Material: PE
- Color: Natural
- Unit: mm

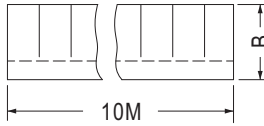

切型
【KG-16S】

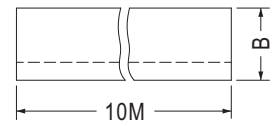

平面型
【KG-016C】

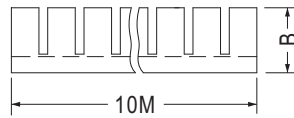
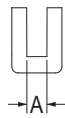

THICKNESS: T

Part No.	A	B	T	Package
KG-010	1.1	5.2	0.9~1.1	10M
KG-012	1.3	5.4	1.1~1.3	
KG-016	1.7	5.4	1.45~1.75	
KG-016S	1.6	5.3	1.45~1.75	
KG-016C	1.7	5.4	1.45~1.75	
KG-020	2.2	5.4	1.8~2.2	
KG-024	2.7	5.7	2.25~2.6	
KG-030	3.3	6.1	2.85~3.25	
KG-040	4.3	6.5	3.85~4.25	

5



- Material: Nylon 66 (UL)
- Flame Class: 94V-2/94V-0
- Color: Natural
- Unit: mm

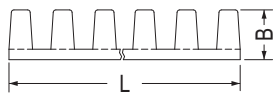
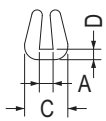

CHASSIS THICKNESS: T

Part No.	A	B	C	D	L	T	Package
KG-006N	0.6	3.8	3.1	0.8	260.0	0.5~0.7	500
KG-008N	0.8	3.8	3.1	0.8	260.0	0.7~0.9	
KG-010N	1.0	3.8	3.3	0.8	260.0	0.9~1.1	
KG-012N	1.2	3.8	3.5	0.8	260.0	1.1~1.3	
KG-014N	1.4	3.8	3.65	0.8	260.0	1.3~1.5	
KG-014N-290	1.4	3.8	3.65	0.8	290.0	1.3~1.5	
KG-016N	1.6	3.8	3.9	0.8	260.0	1.4~1.7	
KG-016LN	1.6	5.3	4.5	0.8	256.0	1.0~1.5	
KG-016LV-2600	1.6	5.3	4.5	1.4	260.0	1.0~1.5	
KG-020N	2.0	3.8	4.3	0.8	260.0	1.8~2.0	
KG-025N	2.5	3.8	4.8	0.8	260.0	2.0~2.5	
KG-030N	3.0	4.8	6.2	0.8	260.0	2.5~3.0	

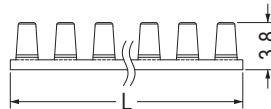
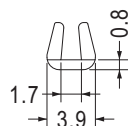

APPLICABLE BOARD THICKNESS 1.4~1.7

Part No.	L	Package
KG-016N-0180	18.0	1000
KG-016N-0930	93.0	500
KG-016N-1080	108.0	

黏貼標誌貼紙 WIRE LABEL

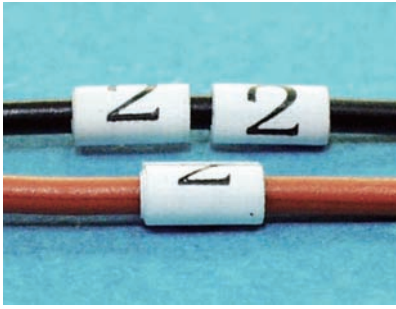

- Material: Vinyl Chloride
- Identical Mark: 0~9 A~Z
- Unit: mm
- 100 pcs of 1 digit on one sheet.

用途：軟式背膠，上印有文字，數字及符號可貼於不同規格電線電纜上，做為電線之標示。

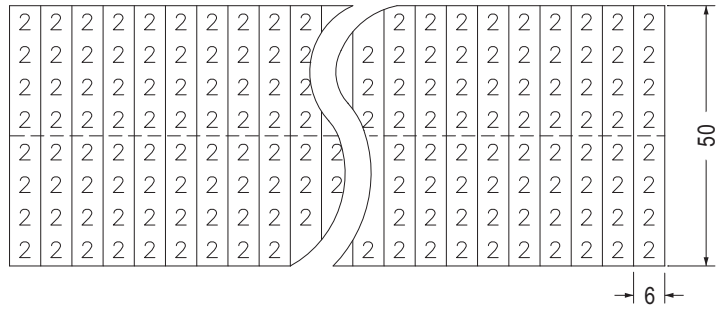

捲式保護帶 SPIRAL WRAPPING BAND

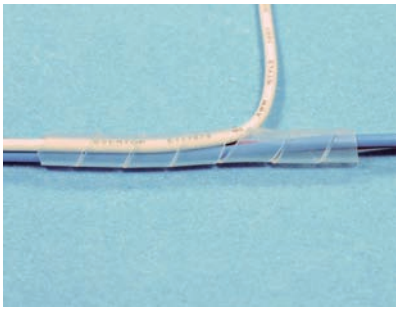

- Material: PE
- Color: Natural
- Unit: mm

用途：引導電線彎曲，電線不易磨損，外觀整齊美觀。

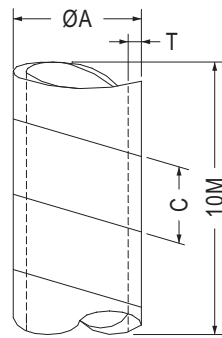

Part No.	A	C	T	Package
SWB-2	3.0	4.6	0.4	10M
SWB-3	4.0	7.6	0.5	
SWB-4S	5.0	8.5	0.5	
SWB-4	6.0	8.5	0.6	
SWB-6	8.0	13.0	0.7	
SWB-7.5	10.0	13.0	0.8	
SWB-9	12.0	15.0	0.85	
SWB-12	15.0	17.0	1.0	
SWB-16	19.0	19.0	1.2	
SWB-20	24.0	21.0	1.5	

快速捲束帶 FAST SPIRAL WRAPPING BAND AND CLAMP



- Spiral Wrap Material: PE
- Spiral Wrap Color: Natural
- Clamp Material: ABS
- Unit: mm

用途：快速引導包覆電線，電線不易磨損，外觀整齊美觀。

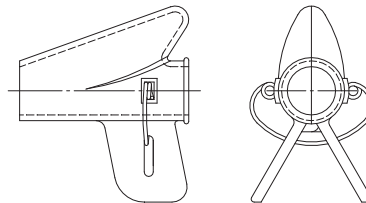

Part No.	The Suitable For Fast Spiral Wrapping Band
KST-08	KYST-8
KST-15	KYST-15
KST-20	KYST-20
KST-25	KYST-25

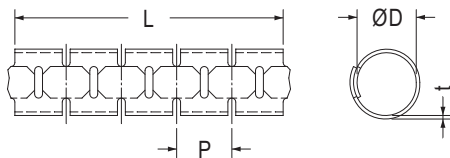

Part No.	Internal ØD (mm)	MAX. DIA (mm)	Pitch P (mm)	Thickness t (mm)	Length L (M)
KYST-08	8.0	10.0	10.0	0.8	5
KYST-15	15.0	16.0	14.0	0.8	
KYST-20	20.0	23.0	17.0	0.9	
KYST-25	25.0	29.0	20.0	1.0	



線扣工具 Bushing Tool	Part No. HT-205-1
----------------------	----------------------



進口束線槍 Cable Tie Gun	Part No. TGN-1
------------------------	-------------------



旗型端子工具 Crimp Tool for flag terminal	Part No. KY-1
---	------------------



國產束線槍 Cable Tie Gun	Part No. TGN-2
------------------------	-------------------



非絕緣端子工具 Non-Isolating Terminal Tool	Part No. KY-2
---	------------------



絕緣端子工具 Isolating Terminal Tool	Part No. HT-301H
--------------------------------------	---------------------

6



- 電晶體墊片
Transistor Washer
- 電晶體座
Transistor Housing
- 零件墊座
Parts Housing
- 華司
Washer
- 矽膠帽套
Silicon Insulator Cover
- 軟質端子保護套
Terminal Soft Sleeves
- 末端套管
VCP Cap
- 保護蓋
Insulated Cap
- 開關蓋
Tact Switch Cap
- 麥克風套
Mic Holder



電晶體蓋 TRANSISTOR COVER

用途：鎖於散熱片上之晶體外殼，絕緣性特佳，防止高壓跳火耐高溫，提高可靠度，增進美觀。

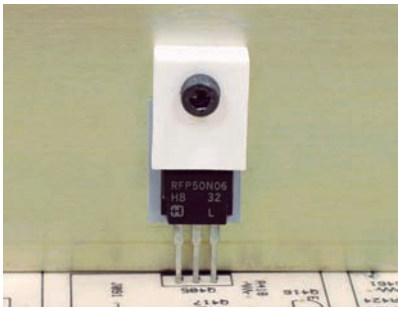

- Material: PBT (UL)/Nylon 66 (UL)
- Flame Class: 94V-2/94V-0
- Color: Natural/Black
- Unit: mm

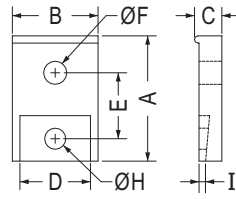

【 TC-1, TC-1A, TC-1C, TC-2, TC-16, TC-18, TC-19 】

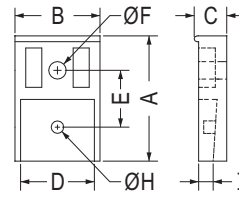

【 TC-3 】

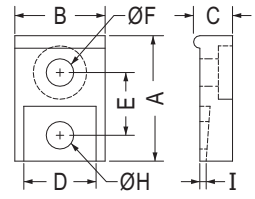

【 TC-4 】

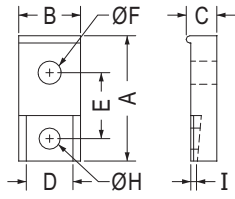

【 TC-5A 】

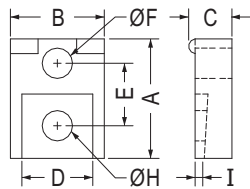

【 TC-6, TC-7, TC-10, TC-11, TC-22, TC-56 】

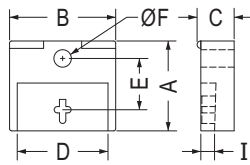

【 TC-8 】

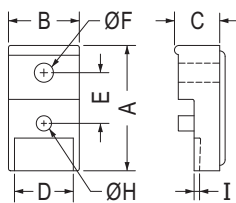

【 TC-9 】

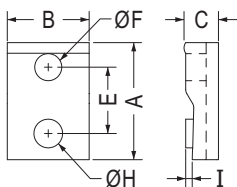

【 TC-13 】

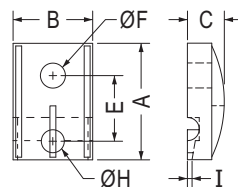

【 TC-20 】

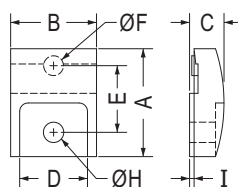

【 TC-23, TC-45 】

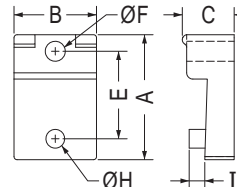

【 TC-35 】

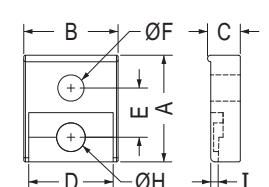

【 TC-38 】

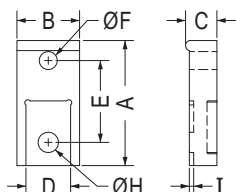

【 TC-40 】

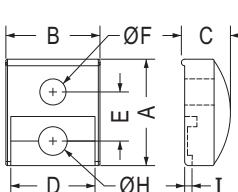

【 TC-46 】

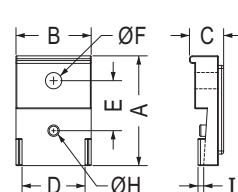

【 TC-73 】

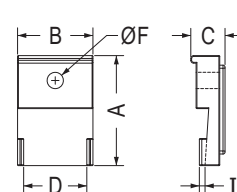

【 TC-74 】

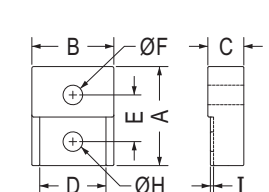

【 TC-75 】

Part No.	A	B	C	D	E	F	H	I	適用晶體	Package
TC-1	16.0	13.0	6.2	10.7	8.0	3.5	3.4	0.8	TO-220	500
TC-1A	19.3	13.0	6.2	10.7	10.0	3.6	3.2	0.8		
TC-1C	17.8	13.0	6.3	10.7	9.3	3.5	3.3	0.9		
TC-2	19.0	18.0	8.0	16.0	10.5	3.5	3.5	1.0	TO-218	
TC-3	28.0	19.0	8.8	16.5	12.8	3.9	2.9	4.0	TO-3P	200
TC-4	16.0	13.0	6.2	10.7	8.0	3.5	3.5	0.8	TO-220	1000
TC-5A	16.0	13.0	6.2	10.5	8.0	3.5	3.5	0.8		
TC-6	13.0	13.2	6.2	10.7	6.8	3.3	3.3	0.8		
TC-7	13.0	13.2	7.0	10.7	6.8	3.3	3.0	2.1		
TC-8	20.0	25.4	7.0	22.5	12.7	3.3	/	2.6	整流器	
TC-9	23.0	12.9	8.3	10.8	9.3	3.5	2.8	1.0	TO-220	500
TC-10	14.3	13.2	6.2	10.5	8.2	3.3	3.2	1.0		
TC-11	14.3	13.2	7.0	10.7	8.2	3.3	2.7	2.1	/	
TC-13	14.3	10.0	4.2	/	8.1	3.3	3.5	0.8		
TC-16	22.5	13.0	6.3	10.5	15.0	3.5	3.5	0.8	TO-220	
TC-18	16.0	13.0	6.2	10.7	8.0	3.5	3.5	0.5	TO-3P	200
TC-19	30.0	18.0	8.0	15.7	17.0	3.6	2.8	2.0		
TC-20	17.7	12.1	5.6	/	10.0	3.8	3.5	0.7	TO-220	500
TC-22	13.0	13.2	6.7	10.7	7.1	3.3	2.8	2.0		
TC-23	19.1	15.2	6.1	12.0	11.8	3.5	3.6	0.8		
TC-35	20.0	13.2	8.3	/	14.0	3.2	3.0	2.5	/	500
TC-38	13.0	11.5	4.0	10.3	6.0	3.2	3.5	0.9		
TC-40	21.55	10.8	5.4	8.3	14.1	3.1	3.5	0.75		
TC-45	22.2	15.2	6.1	12.0	14.9	3.6	3.5	0.8		
TC-46	13.0	11.5	6.0	10.3	6.0	3.2	3.5	0.9	TO-220	
TC-56	14.3	13.2	6.2	10.5	8.2	3.3	3.2	0.5	TO-3P	
TC-73	27.0	18.5	8.4	15.5	12.3	4.0	2.8	1.4		
TC-74	27.0	18.5	8.4	15.5	/	4.0	/	1.4	TO-220	1000
TC-75	15.7	13.0	5.7	10.5	7.4	3.1	3.1	0.5		

【 TC-40 】

【 TC-46 】

【 TC-73 】

【 TC-74 】

【 TC-75 】

電晶體蓋 TRANSISTOR COVER

用途：鎖於散熱片上之晶體外殼，絕緣性特佳，防止高壓跳火耐高溫，提高可靠度，增進美觀。

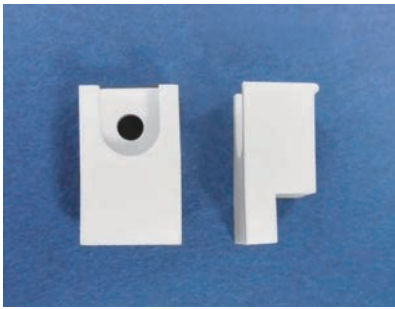

- Material: PBT (UL)
- Flame Class: 94V-0
- Color: Natural
- Unit: mm

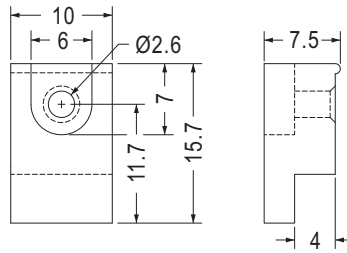

Part No.	Package
TC-39	1000

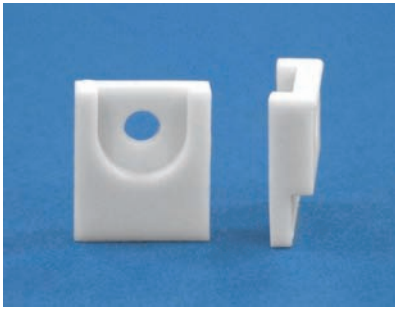

- Material: Nylon 66 (UL)
- Flame Class: 94V-2/94V-0

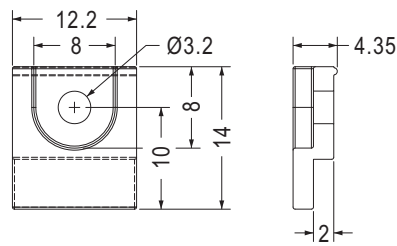

Part No.	Package
TC-41	1000

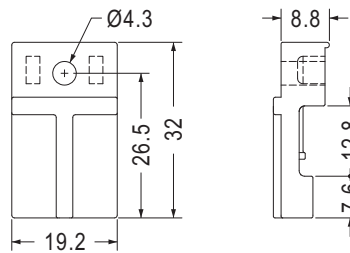
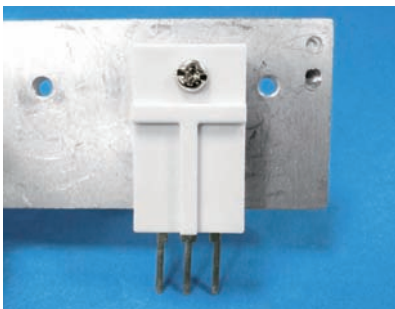

Part No.	Package
TC-52	1000

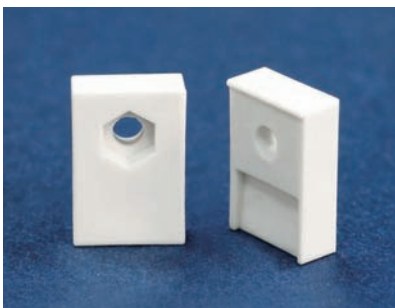

- Material: PBT (UL)
- Flame Class: 94V-0
- Color: Natural
- Unit: mm

用途：用於TO-220功率晶體，鎖於散熱片上之晶體外殼，絕緣性特佳，防止高壓跳火，耐高溫，提高可靠度，增進美觀。

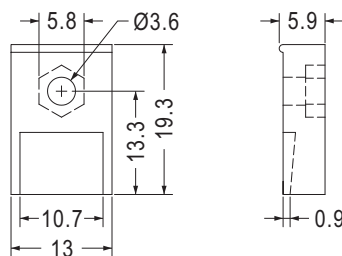

Part No.	Package
TC-21	1000

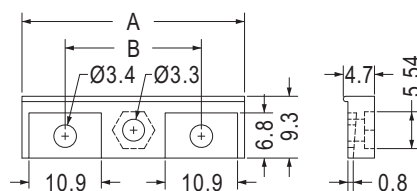
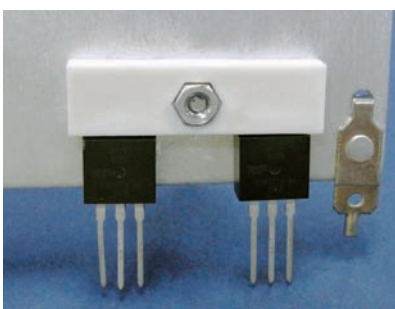

Part No.	A	B	Package
TC-29	33.5	20.5	1000
TC-53	34.3	21.7	

電晶體蓋 TRANSISTOR COVER

用途：用於TO-220功率晶體，鎖於散熱片上之晶體外殼，絕緣性特佳，防止高壓跳火，耐高溫，提高可靠性，增進美觀。

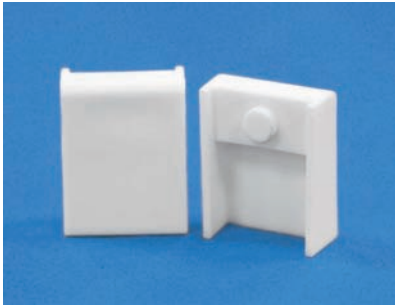

- Material: PBT (UL)
- Flame Class: 94V-0
- Color: Natural
- Unit: mm

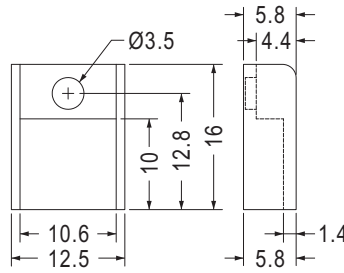

Part No.	Package
TC-58	1000

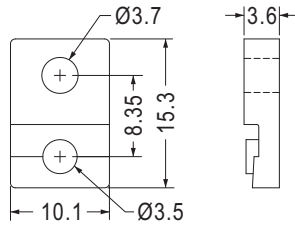

- Color: Natural/Black

Part No.	Package
TC-49	1000

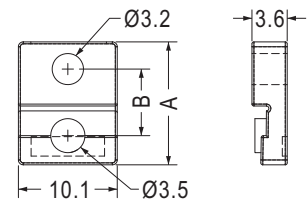

- Color: Natural/Black

Part No.	A	B	Package
TC-70	12.65	6.85	1000
TC-71	11.45	5.65	

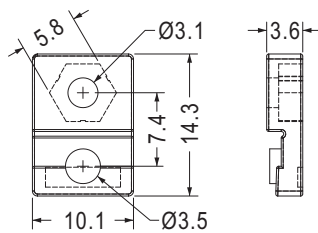
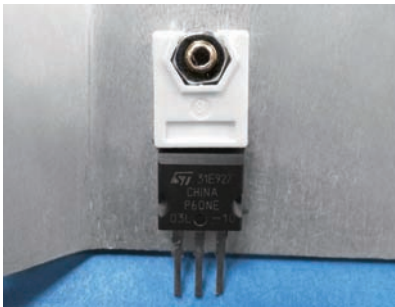

Part No.	Package
TC-50	1000

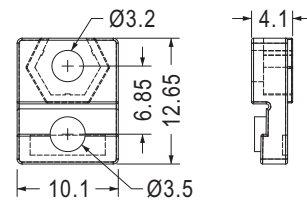

Part No.	Package
TC-51	1000



- Material: Nylon 66 (UL)
- Flame Class: 94V-2/94V-0
- Color: Natural
- Unit: mm

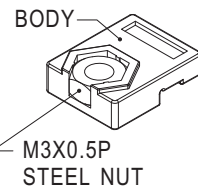
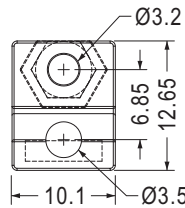

Part No.	Package
TC-76F	1000



- Material: Nylon 66 (UL)
- Flame Class: 94V-2/94V-0
- Color: Natural
- Unit: mm

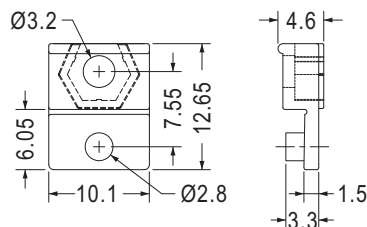

Part No.	Package
TC-77	1000

電晶體蓋 TRANSISTOR COVER

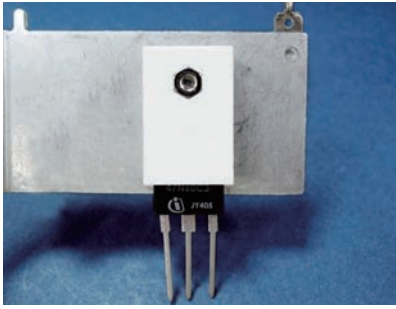

- Material: PBT (UL)
- Flame Class: 94V-0
- Color: Natural
- Unit: mm

用途：用於TO-3P功率晶體，鎖於散熱片上之晶體外殼，絕緣性特佳，防止高壓跳火，耐高溫，提高可靠度，增進美觀。

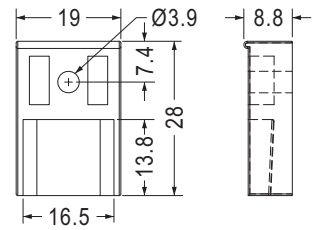
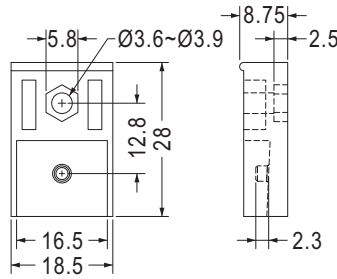

Part No.	Package
TC-48	250

Part No.	Package
TC-68	1000

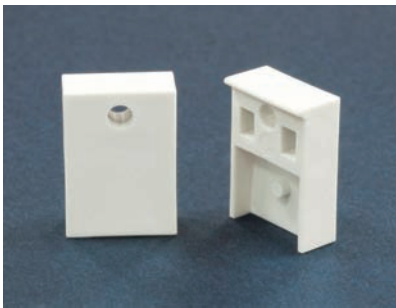

- Material: PBT (UL)
- Flame Class: 94V-0
- Color: Natural
- Unit: mm

用途：用於TO-247功率晶體，鎖於散熱片上之晶體外殼，絕緣性特佳，防止高壓跳火，耐高溫，提高可靠度，增進美觀。

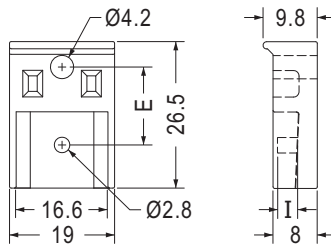

Part No.	E	I	Package
TC-60	14.1	1.8	200
TC-67	14.1	3.3	
TC-72	16.5	3.3	

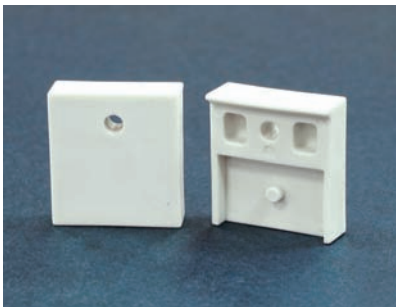

- Material: PBT (UL)
- Flame Class: 94V-0
- Color: Natural
- Unit: mm

用途：用於TO-264功率晶體，鎖於散熱片上之晶體外殼，絕緣性特佳，防止高壓跳火，耐高溫，提高可靠度，增進美觀。

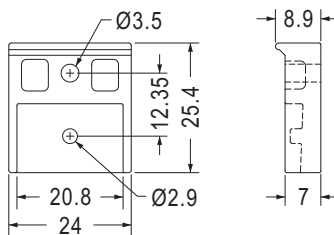

Part No.	Package
TC-61	1000

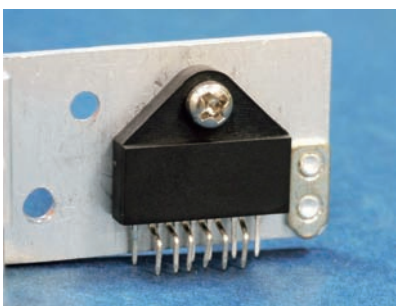

- Material: PBT (UL)
- Flame Class: 94V-0
- Color: Black
- Unit: mm

用途：鎖於散熱片上之功率IC外殼絕緣性特佳，防止高壓跳火耐高溫，提高可靠度，增進美觀。

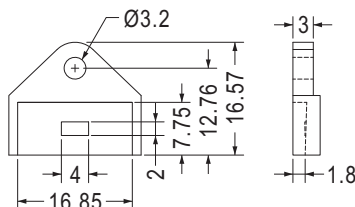

Part No.	Package
TC-62	1000

橋式整流蓋 BRIDGE RECTIFIER COVER

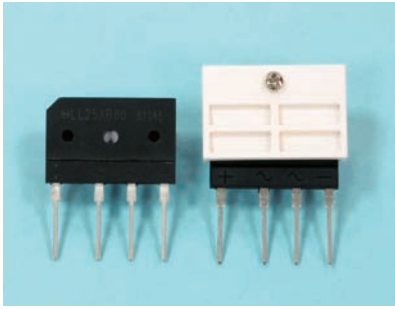

- Material: PBT (UL)
- Flame Class: 94V-0
- Color: Natural
- Unit: mm

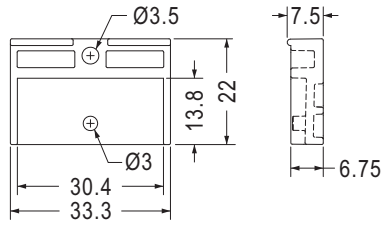

Part No.	Package
TC-59	500

用途：鎖於散熱片上之橋式整流器外殼，絕緣性特佳，防止高壓跳火耐高溫，提高可靠度，增進美觀。

功率IC蓋 POWER IC COVER

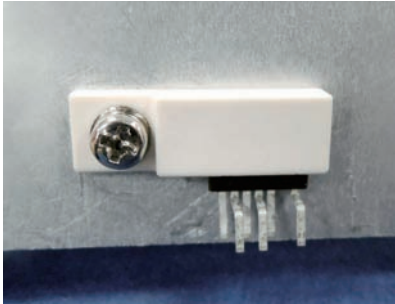

- Material: Nylon 66 (UL)/PBT (UL)
- Flame Class: 94V-2/94V-0
- Color: Natural
- Unit: mm

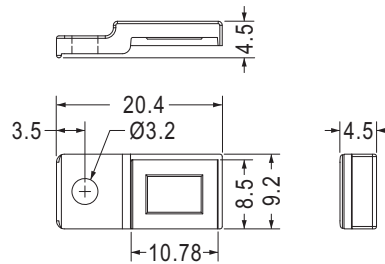

Part No.	Package
TC-26	1000

用途：鎖於散熱片上之功率IC外殼絕緣性特佳，防止高壓跳火耐高溫，提高可靠度，增進美觀。

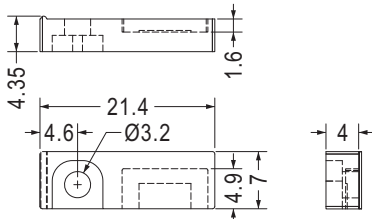

Part No.	Package
TC-31	1000

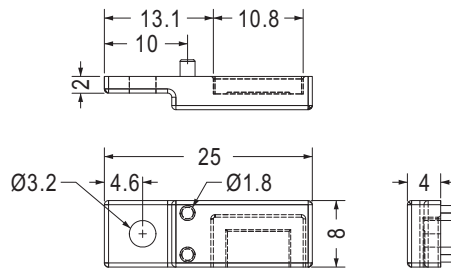

MOUNTING HOLE

Part No.	Package
PH-44	1000

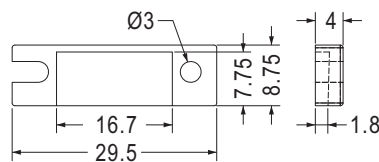
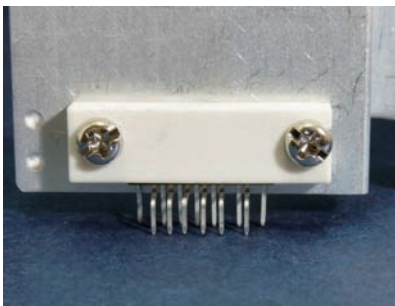
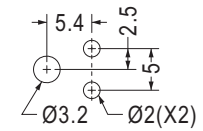

MOUNTING HOLE
M3X0.5P

Part No.	Package
TC-42	1000

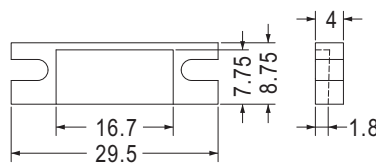

MOUNTING HOLE
M3X0.5P OR Ø3.2

Part No.	Package
TC-47	1000

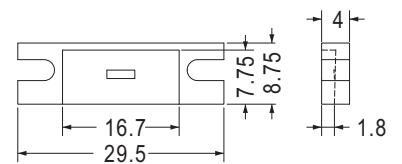

MOUNTING HOLE
M3X0.5P OR Ø3.2

Part No.	Package
TC-63	1000

功率IC蓋 POWER IC COVER

用途：鎖於散熱片上之功率IC外殼絕緣性特佳，防止高壓跳火耐高溫，提高可靠度，增進美觀。

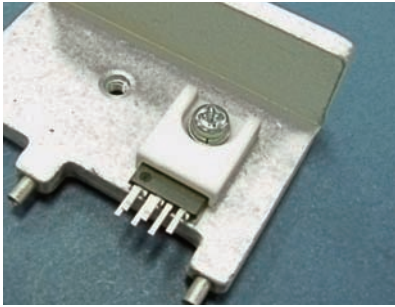

- Material: Nylon 66 (UL)/PBT (UL)
- Flame Class: 94V-2/94V-0
- Color: Natural
- Unit: mm

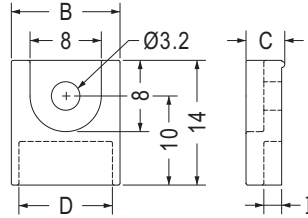

【 TC-24, TC-30 】

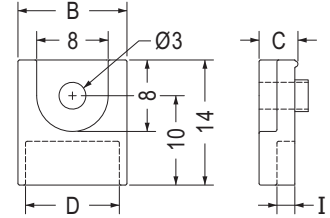

【 TC-25 】

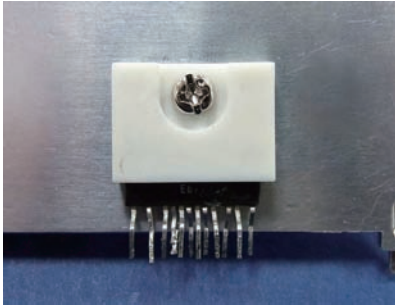

Part No.	B	C	D	I	Package
TC-24	12.2	4.4	10.5	2.0	500
TC-25	12.2	4.35	10.5	2.0	1000
TC-30	19.0	4.35	17.0	1.6	

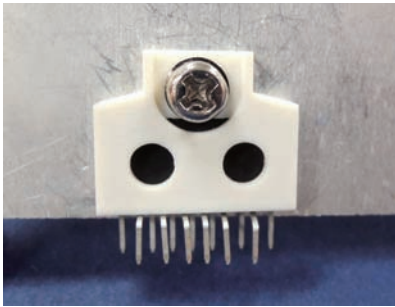

- Material: PBT (UL)
- Flame Class: 94V-0
- Color: Natural
- Unit: mm

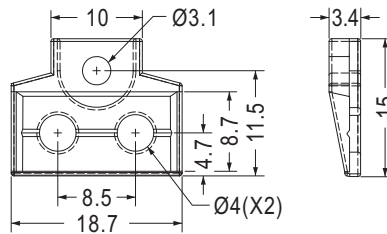

Part No.	Package
TC-54	1000

電晶體蓋 TRANSISTOR COVER

用途：用於功率晶體之外殼絕緣。

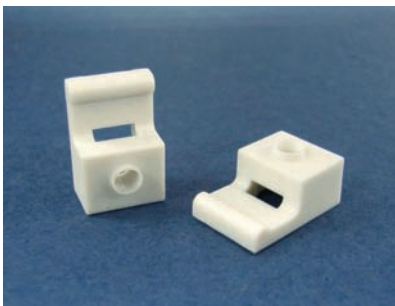

- Material: PBT (UL)
- Flame Class: 94V-0
- Color: Natural
- Unit: mm

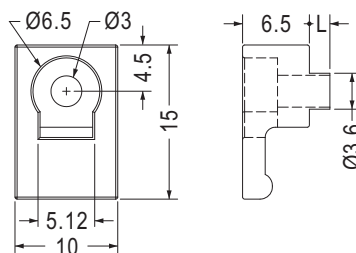

Part No.	L	Package
TC-28-1	1.0	2000
TC-28-2	2.0	

電晶體座 TRANSISTOR COVER

用途：鎖於散熱片上之功率IC外殼絕緣性特佳，防止高壓跳火耐高溫，提高可靠度，增進美觀。

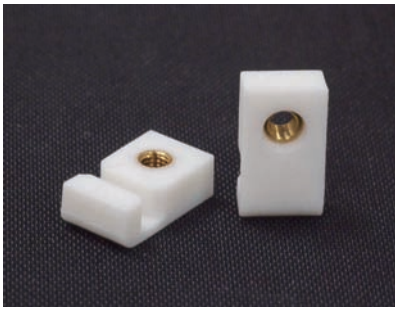

- Material: Nylon 66 (UL)
- Flame Class: 94V-2/94V-0
- Color: Natural
- Unit: mm

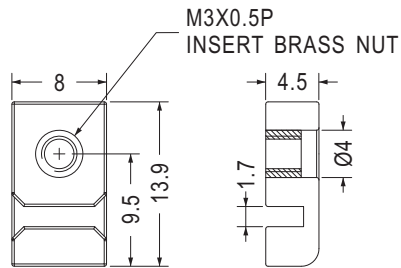

Part No.	Package
TC-65	1000



- Body Material: Nylon 66 (UL)/PPS (UL)
- Flame Class: 94V-2/94V-0
- Clip Material: SUS
- Color: Black
- Unit: mm

用途：鎖於散熱片之晶體外殼，絕緣性特性，防止高壓跳火耐高溫，提高可靠度，增進美觀。

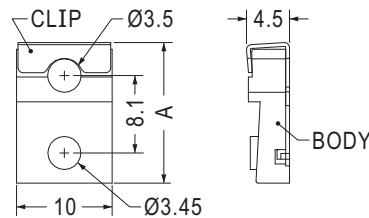

Part No.	A	Package
TCSE-1	14.5	1000
TCSE-7	14.7	



- Body Material: PPS (UL)
- Flame Class: 94V-0
- Clip Material: SUS
- Color: Black
- Unit: mm

用途：用於TO-220功率晶體，鎖於散熱片上之晶體外殼，絕緣性特佳，防止高壓跳火，耐高溫，提高可靠度，增進美觀。

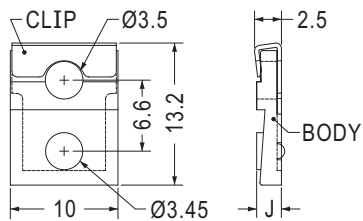

Part No.	J	Package
TCSE-2F	2.1	1000
TCSE-3F	2.2	



- Material: Nylon 66 (UL)
- Flame Class: 94V-2/94V-0
- Clip Material: Nickel Plated Steel
- Color: Black
- Unit: mm

用途：用於TO-3P功率晶體，保護晶體立於PC板上，使接腳不彎曲、折斷、短路，且高度一致。

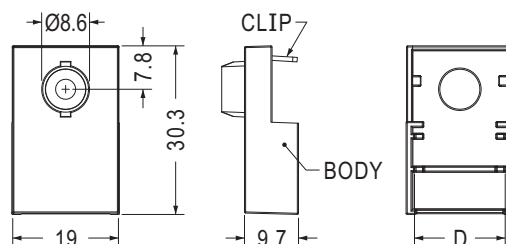

Part No.	D	Package
TCSE-8F	15.8	1000
TCSE-8SF	15.5	

壓板 DEPRESSOR

用途：用於壓著電子零件或功率晶體。

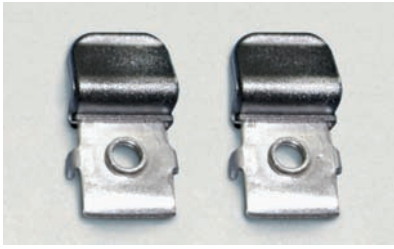

- Material: Nylon 66 (UL) 94V-2
- Metal Material: SUS
- Color: Black
- Unit: mm

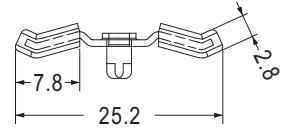
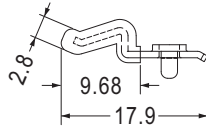
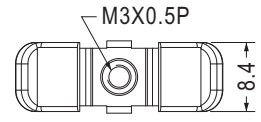
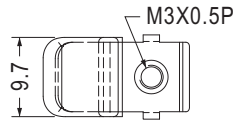

Part No.	Package
TRK-17AF	1000

Part No.	Package
TRK-16F	1000

功率晶體壓板 POWER TRANSISTOR CLAMP DEPRESSOR

用途：可將功率晶體快速固定於散熱片上，方便、耐高壓。



- Material: Nylon 66 (UL)
- Flame Class: 94V-2/94V-0
- Color: Black
- Unit: mm

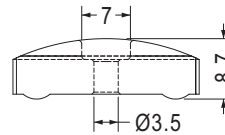
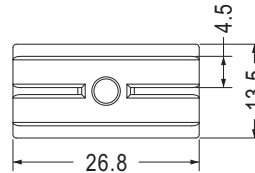

Part No.	Package
TRK-35	500



- Material: PBT (UL)
- Metal Material: Steel Zinc Plated
- Flame Class: 94V-0
- Color: Black
- Unit: mm

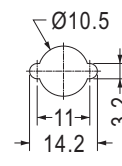
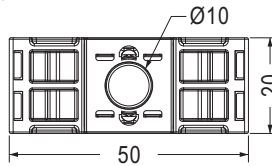

RECOMMEND MOUNTING HOLE



• Patent Pending(專利申請中)

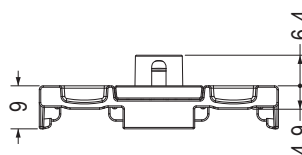

Part No.	Package
TCSF-2F	200

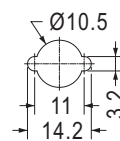
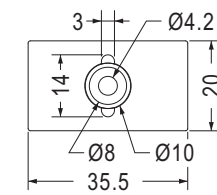

RECOMMEND MOUNTING HOLE

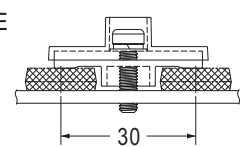
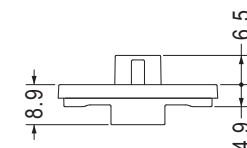
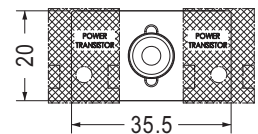

Part No.	Package
★TCSF-3F	500

功率晶體壓板 POWER TRANSISTOR CLAMP DEPRESSOR

用途：可將功率晶體快速固定於散熱片上，方便、耐高壓。



- Material: Zinc Plated SPCC
- Unit: mm

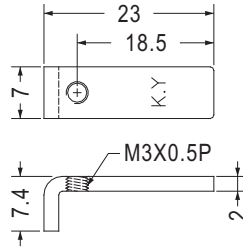

Part No.	Package
TRK-11	500

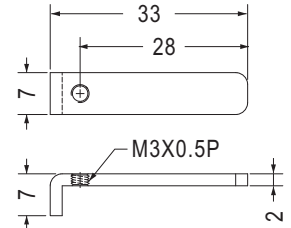

Part No.	Package
TRK-54	500

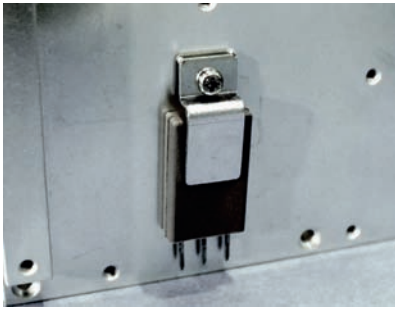

- Material: Zinc Plated Steel
- Unit: mm

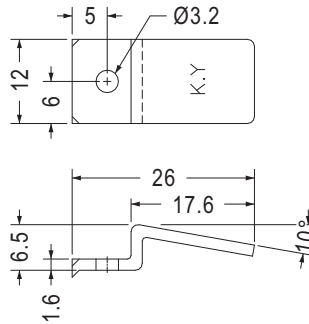

Part No.	Package
TRK-1	250

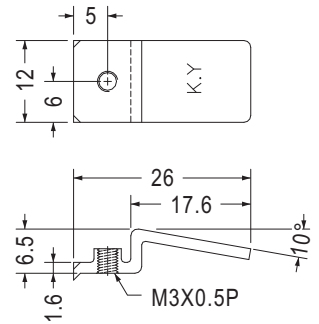

Part No.	Package
TRK-2	250



- Material: SUS
- Unit: mm

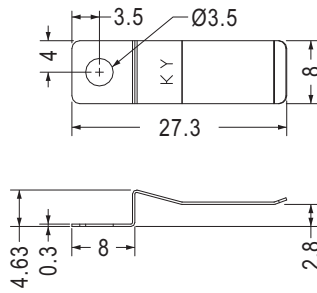

Part No.	Package
TRK-6	1000

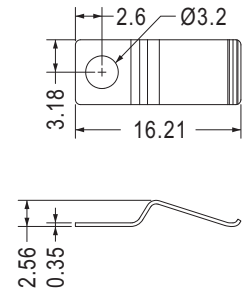

Part No.	Package
TRK-67	1000



- Material: SUS
- Unit: mm

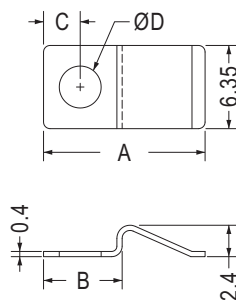

Part No.	A	B	C	D	Package
TRK-24	12.33	6.0	2.8	3.2	2000
TRK-52	12.73	6.8	3.2	3.4	

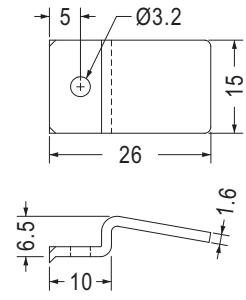

Part No.	Package
TRK-56	1000

- Material: Zinc Plated Steel

功率晶體壓板 POWER TRANSISTOR CLAMP DEPRESSOR

用途：可將功率晶體快速固定於散熱片上，方便、耐高壓。



- Material: Zinc Plated Spring Stainless
- Unit: mm

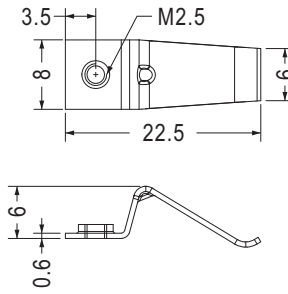

Part No.	Package
TRK-40	500



- Material: SUS
- Unit: mm

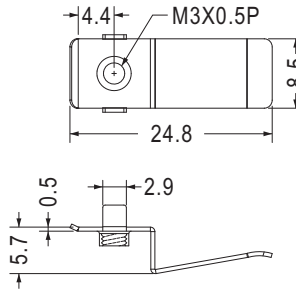

Part No.	Package
TRK-22	1000



- Material: Zinc Plated SK5
- Unit: mm

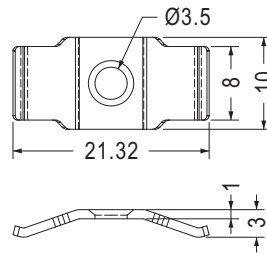

Part No.	Package
TRK-12	1000

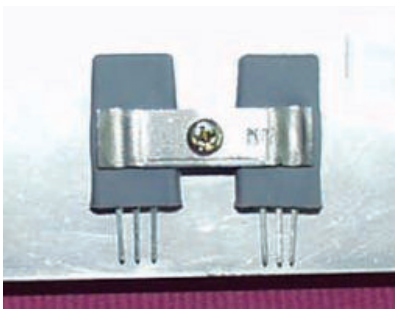

- Material: Zinc Plated Steel
- Unit: mm

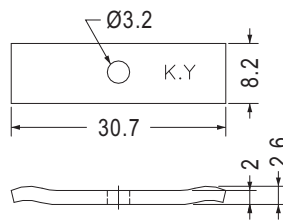

Part No.	Package
TRK-8	500

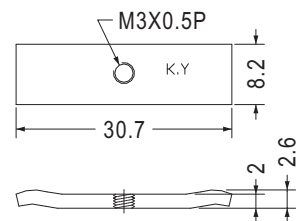

Part No.	Package
TRK-9	500

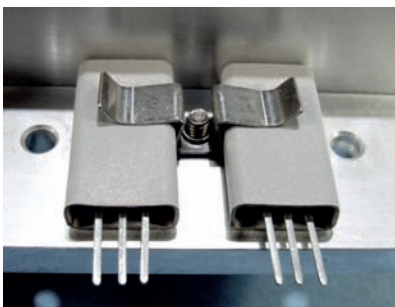

- Material: SUS
- Unit: mm

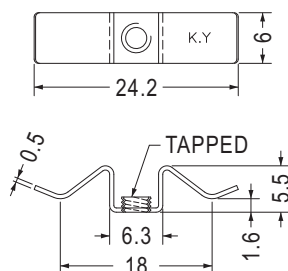

Part No.	Tapped	Package
TRK-10	M3X0.5P	1000
TRK-10(M4)	M4X0.8P	
TRK-10(632)	6-32 UNC	

熱敏電阻座 NTC THERMISTOR SENSOR HOUSING

用途：用於熱敏電阻接腳之固定與保護。

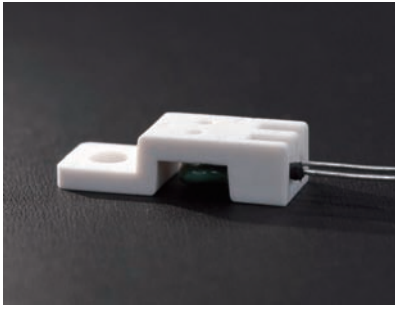

- Material: PBT (UL)
- Flame Class: 94V-0
- Color: Natural
- Unit: mm

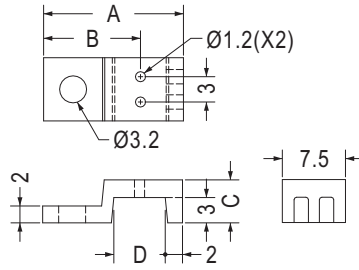

Part No.	A	B	C	D	Package
PH-1A	16.6	11.5	5.1	6.1	1000
PH-11	17.15	11.8	4.6	6.7	

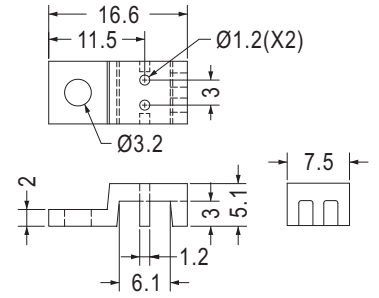

Part No.	Package
PH-24	1000

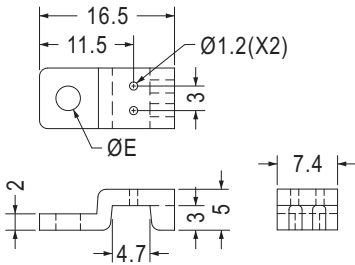

Part No.	E	Package
PH-1	3.2	1000
PH-47	5.15	

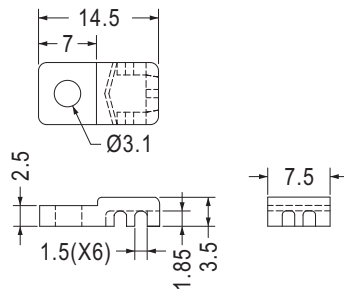

Part No.	Package
PH-2	1000

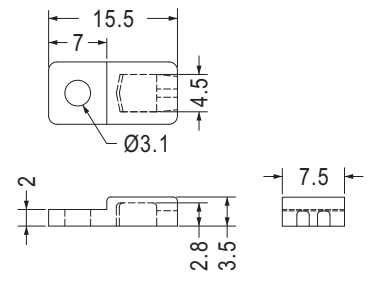

Part No.	Package
PH-2A	1000

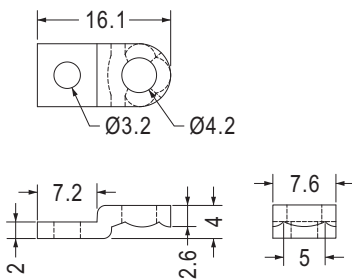

Part No.	Package
PH-3	1000

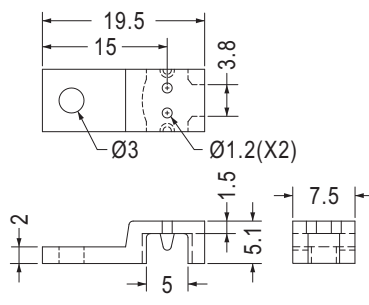

Part No.	Package
PH-7	1000

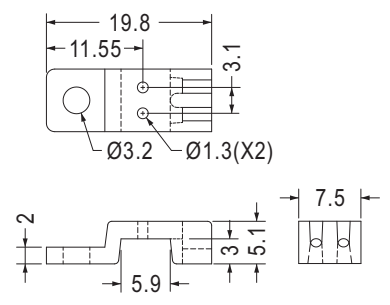

Part No.	Package
PH-5	1000

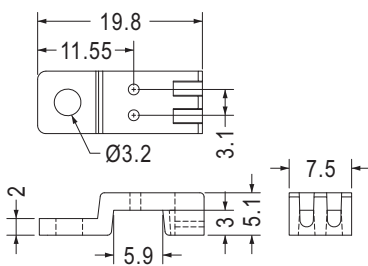

Part No.	Package
PH-53	1000

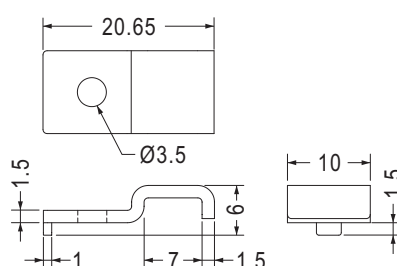

Part No.	Package
PH-12	1000

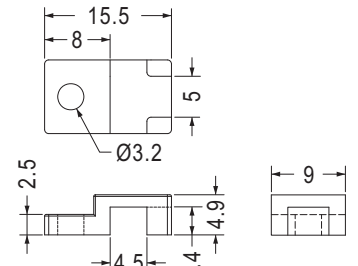

Part No.	Package
PH-14	1000

熱敏電阻座 NTC THERMISTOR SENSOR HOUSING

用途：用於熱敏電阻接腳之固定與保護。



- Material: PBT (UL)
- Flame Class: 94V-0
- Color: Natural
- Unit: mm

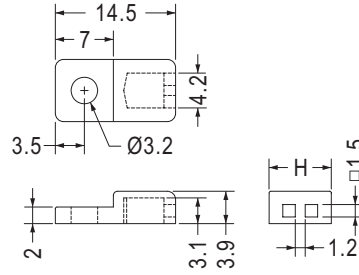

Part No.	H	Package
PH-16	7.5	1000
PH-18	6.3	

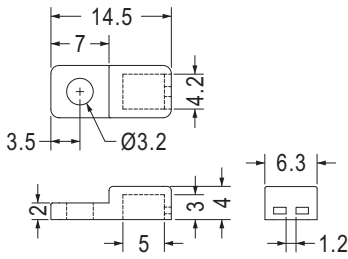

Part No.	Package
PH-20	1000

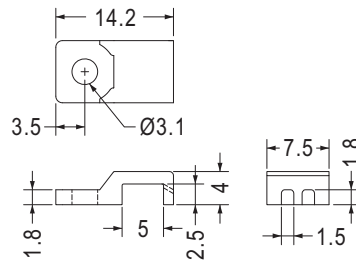

Part No.	Package
PH-46	1000

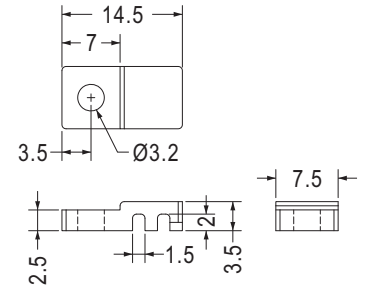

Part No.	Package
PH-50	1000

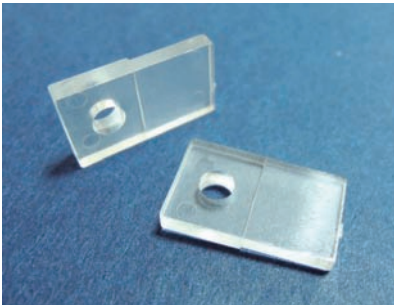

- Material: PC (UL)
- Flame Class: 94V-2/94V-0
- Color: Natural
- Unit: mm

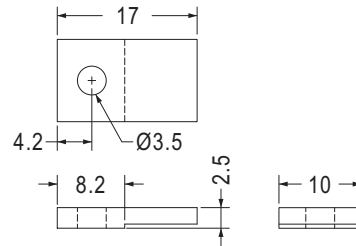

Part No.	Package
PH-13	1000

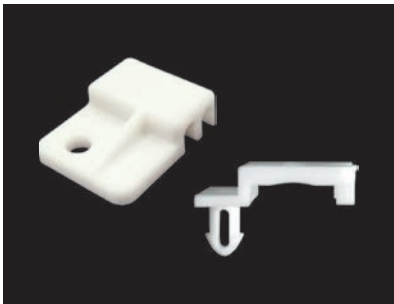

- Material: Nylon 66 (UL)
- Flame Class: 94V-2/94V-0
- Color: Natural/Black
- Unit: mm

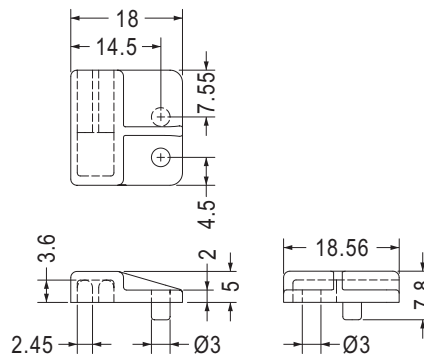

Part No.	Package
PH-21	1000

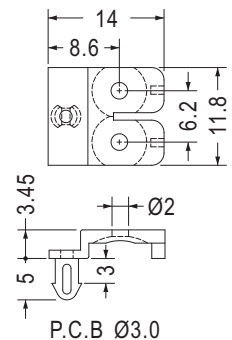

Part No.	Package
PHK-1	1000

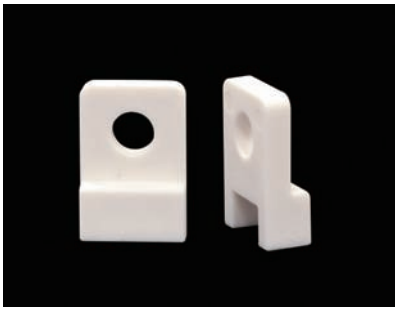

- Material: PBT (UL)
- Flame Class: 94V-0
- Color: Natural
- Unit: mm

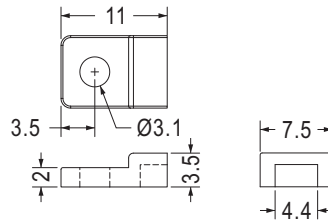

Part No.	Package
PH-49	1000

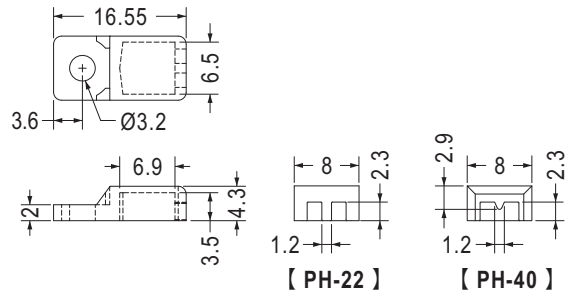

Part No.	Package
PH-22	1000
PH-40	



- Material: Nylon 66 (UL)/PBT (UL)
- Flame Class: 94V-2/94V-0
- Color: Natural/Black
- Unit: mm

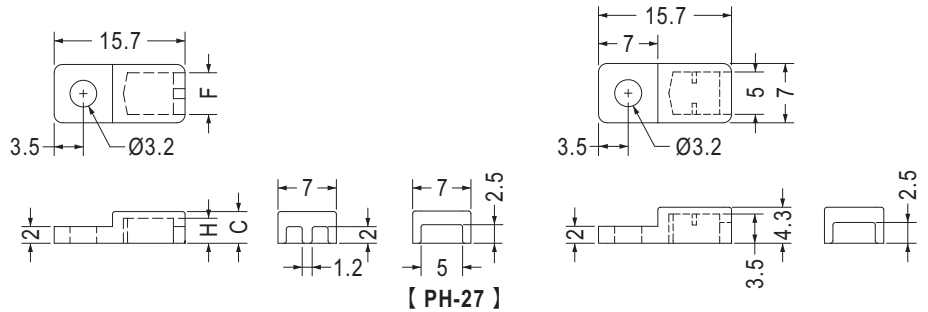

Part No.	C	F	H	Package
PH-23	3.8	5.0	3.0	1000
PH-23L	3.8	5.4	3.4	
PH-27	4.3	5.0	3.5	

Part No.	Package
PH-31	1000



- Material: PC (UL)
- Flame Class: 94V-0
- Color: Black
- Unit: mm

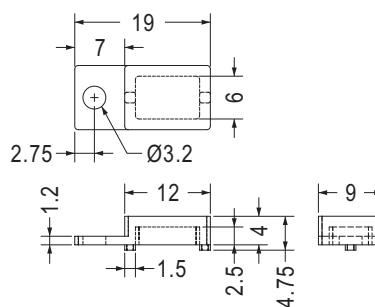

Part No.	Package
PH-30	1000

熱敏電阻座 NTC THERMISTOR SENSOR HOUSING

用途：用於熱敏電阻接腳之固定與保護。

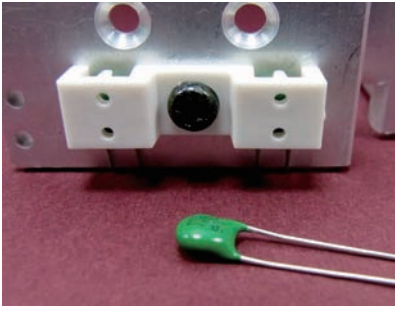

- Material: PC (UL)
- Flame Class: 94V-0
- Color: Natural
- Unit: mm

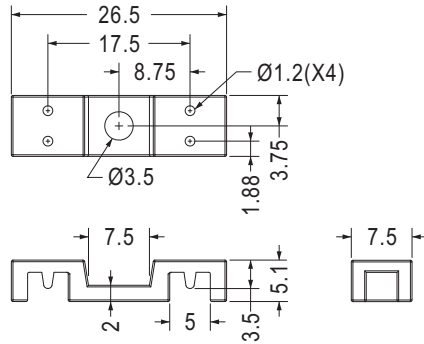

Part No.	Package
PH-37	1000

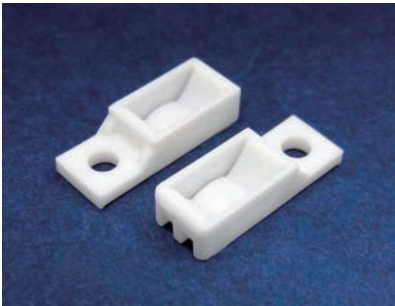

- Material: Nylon 66 (UL)
- Flame Class: 94V-2/94V-0
- Color: Natural/Black
- Unit: mm

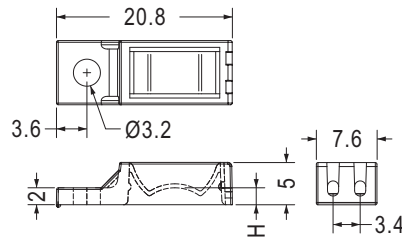

Part No.	H	Package
PHG-2	2.0	1000
PHG-3	0.71	

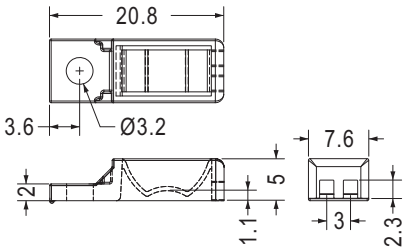

Part No.	Package
PHG-6	1000

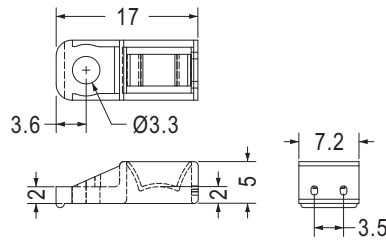

Part No.	Package
PHG-4	1000

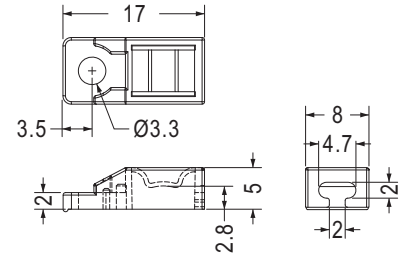

Part No.	Package
PHG-11	1000

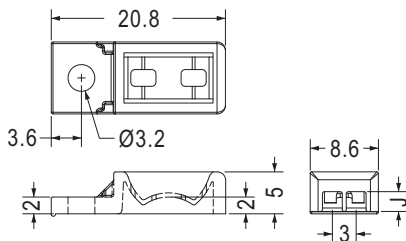

Part No.	J	Package
PHG-8	1.2	1000
PHG-10	2.5	

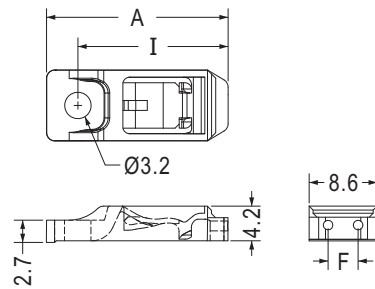

Part No.	A	F	I	Package
PHG-12	22.0	3.8	18.2	1000
PHG-14	21.5	3.5	17.7	

熱敏電阻座 NTC THERMISTOR SENSOR HOUSING

用途：用於熱敏電阻接腳之固定與保護。



- Material: PBT (UL)
- Flame Class: 94V-0
- Color: Natural
- Unit: mm

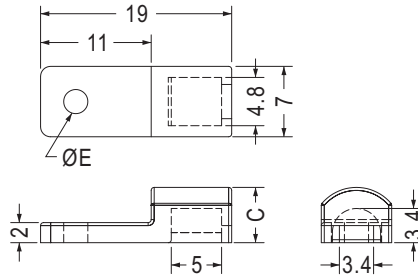

Part No.	C	E	Package
PH-28	5.5	2.4	1000
PH-48	3.4	3.2	

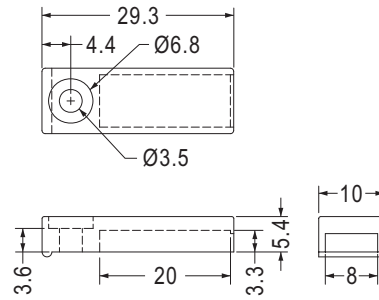
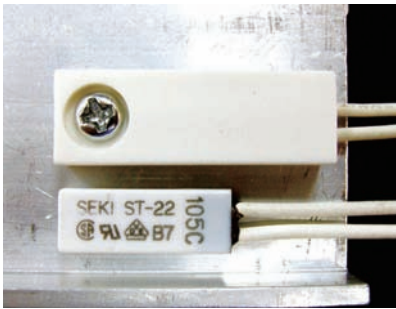

Part No.	Package
PH-15	1000

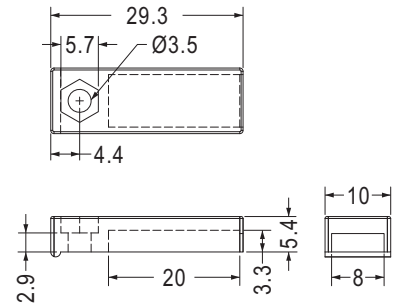

Part No.	Package
PH-43	1000

6



- Material: Nylon 66 (UL)
- Flame Class: 94V-2/94V-0
- Color: Natural/Black
- Unit: mm

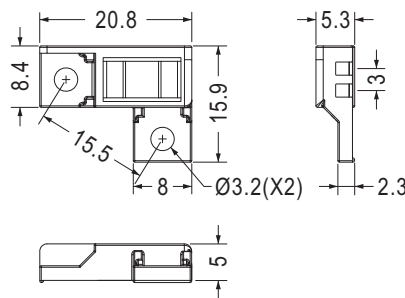

Part No.	Package
PHG-7	1000

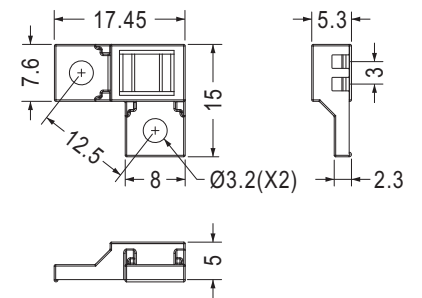

Part No.	Package
PHG-15	1000

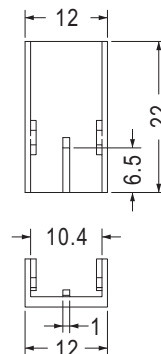

Part No.	Package
PH-34	1000

熱敏電阻座 THERMISTOR HOLDER

用途：用於熱敏電阻之固定。



- Material: Nickel Plated Brass
- Unit: mm

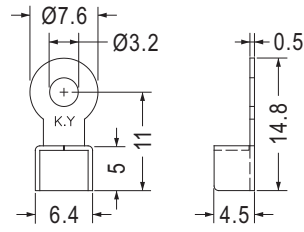

Part No.	Package
GND-27	1000

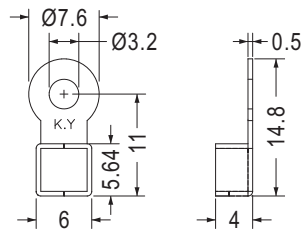

Part No.	Package
GND-48	1000

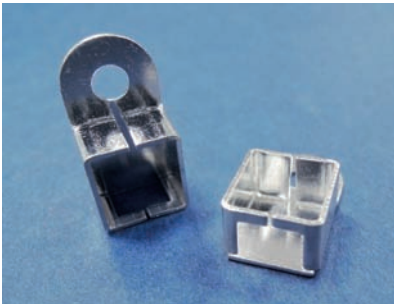

- Material: Bright Tin Plated Brass
- Unit: mm

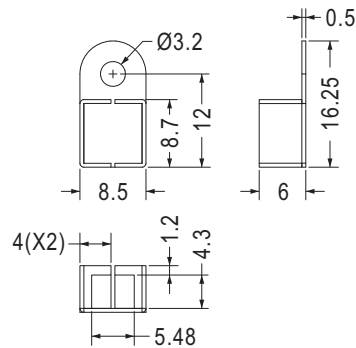

Part No.	Package
GND-75	1000

電晶體墊片 TRANSISTOR WASHER

用途：用於功率晶體之固定。



- Material: PBT (UL)
- Flame Class: 94V-0
- Color: Natural
- Unit: mm

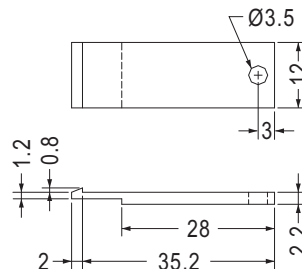

Part No.	Package
TCP-1	1000

電晶體墊片 TRANSISTOR WASHER

用途：鎖於電晶體上，避免晶體外殼與散熱片間造成短路。



- Material: PBT/PC V-2/PC V-0/POM/PPS/N46 V-0/N6 V-2/N66 V-2/N66 V-0
- Color: Natural/Black
- Unit: mm

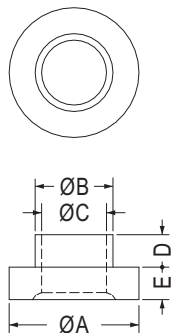
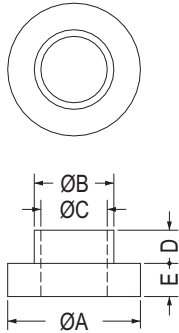

【 TW-6A 】

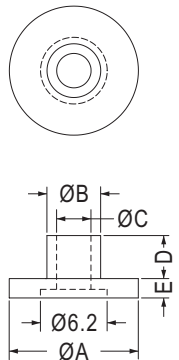

【 TW-66 】

Part No.	A	B	C	D	E	Package
TW-1	6.0	3.6	3.0	1.5	1.5	2000
TW-2	6.2	3.5	3.0	3.0	1.5	
TW-3	6.2	3.55	3.0	2.5	2.0	
TW-4	6.0	3.5	3.0	2.0	2.0	
TW-5	6.2	3.5	3.0	1.2	1.0	
TW-6	6.2	3.5	3.0	1.4	1.2	
TW-6A	6.2	3.55	3.0	1.4	1.2	
TW-7	8.0	3.8	3.1	2.8	1.2	
TW-8	8.0	3.8	3.1	1.2	1.2	
TW-9	10.0	6.0	5.0	5.0	1.0	
TW-10	10.0	5.0	4.0	4.0	1.0	1000
TW-11	9.5	6.3	4.5	1.2	1.2	
TW-12	9.5	6.3	4.1	0.8	1.7	
TW-14	9.9	8.3	6.5	1.5	1.0	
TW-15	6.2	3.6	3.0	2.4	1.9	
TW-16	6.1	3.5	3.0	1.6	1.4	
TW-17	6.1	3.55	3.0	1.5	2.0	
TW-18	6.35	5.15	3.5	1.6	0.6	
TW-20	6.5	3.5	3.0	4.0	0.9	
TW-21	7.0	5.0	3.0	5.8	2.0	
TW-22	11.9	7.9	4.0	3.0	2.6	2000
TW-23	7.1	5.0	3.0	2.3	2.0	
TW-24	6.4	3.55	2.95	2.0	1.3	
TW-25	7.92	4.83	3.05	0.8	1.14	
TW-26	6.0	3.6	3.0	5.2	1.0	
TW-27	6.0	3.55	2.95	1.4	1.4	
TW-29	14.0	7.5	6.0	1.8	1.2	
TW-30	14.0	9.8	6.6	1.7	0.9	
TW-31	16.0	11.4	10.0	0.8	0.7	
TW-33	6.0	3.5	2.5	7.2	5.0	
TW-34	6.0	3.5	2.5	11.0	5.0	
TW-35	6.0	3.55	2.95	1.2	1.3	
TW-36	15.7	9.7	4.5	6.5	5.0	1000
TW-37	6.0	3.55	2.95	3.2	2.0	2000
TW-38	6.1	3.5	2.95	1.5	1.1	
TW-39	5.46	3.43	2.95	0.81	1.02	
TW-41	6.6	4.95	2.6	6.0	1.5	
TW-42	6.35	4.78	3.94	1.57	3.18	1000
TW-43	25.4	11.0	8.3	2.29	1.58	
TW-48	11.0	8.0	5.5	8.0	1.3	2000
TW-49	6.4	3.53	3.0	2.0	1.2	
TW-53	11.8	6.0	4.0	1.9	0.5	
TW-57	10.0	4.3	3.45	3.0	1.0	
TW-58	6.2	3.5	3.0	2.5	2.7	
TW-59	6.2	3.5	3.0	2.5	2.0	
TW-60	6.4	3.5	3.0	2.0	1.3	
TW-61	6.0	3.5	3.0	3.2	2.0	
TW-62	6.1	3.5	3.0	1.5	1.1	
TW-63	10.0	5.0	3.95	4.0	0.5	
TW-64	4.0	2.7	2.1	0.8	0.8	2000
TW-65	6.0	3.55	3.0	4.6	2.0	
TW-66	12.0	5.0	3.2	4.0	1.8	
TW-70	6.2	3.6	2.95	2.9	1.9	
TW-73	9.0	6.0	4.5	8.0	2.0	
TW-75	7.0	4.4	3.2	7.5	0.5	
TW-77	5.0	4.1	2.2	1.2	1.2	
TW-78	21.0	17.4	16.2	2.8	0.8	
TW-79	6.0	3.6	2.95	2.4	1.2	
TW-80	6.0	3.6	2.95	4.8	1.2	

電晶體墊片 TRANSISTOR WASHER

用途：鎖於電晶體上，避免晶體外殼與散熱片間造成短路。



- Material: PBT/PC V-2/PC V-0/POM/
PPS/N46 V-0/N6 V-2/
N66 V-2/N66 V-0
- Color: Natural/Black
- Unit: mm

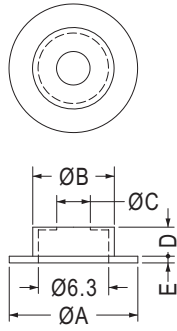
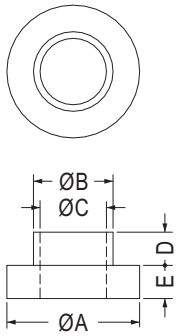

【 TW-105 】

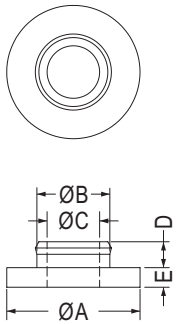

【 TW-109 】

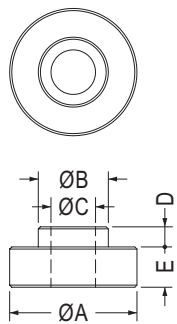

【 TW-131, TW-148, TW-179 】

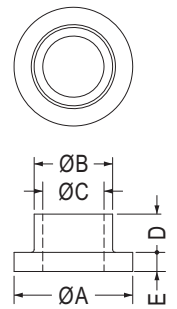

【 TW-149, TW-192 】

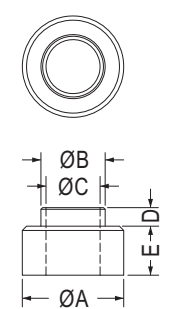

【 TW-182 】

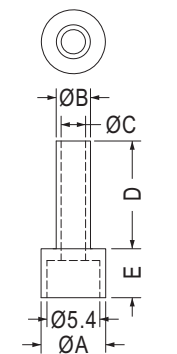

【 TW-164 】

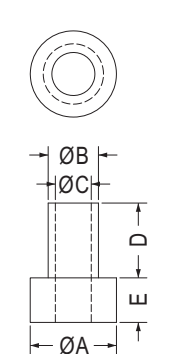

【 TW-185, TW-186 】

Part No.	A	B	C	D	E	Package
TW-84	6.2	3.6	2.95	12.0	1.9	2000
TW-85	6.1	3.5	2.9	1.85	1.4	
TW-88	6.0	3.5	3.0	2.3	1.8	
TW-90	6.3	3.5	3.0	2.6	1.2	
TW-97	9.0	3.5	3.0	3.5	1.0	
TW-99	6.0	3.8	3.1	6.5	1.2	
TW-100	6.1	3.5	3.0	2.1	1.4	
TW-101	6.1	3.5	3.0	2.7	1.4	
TW-102	12.7	6.7	4.3	1.5	1.46	
TW-104	15.0	7.9	6.2	4.0	1.5	
TW-105	11.5	7.3	3.1	2.6	0.6	
TW-106	9.5	6.5	5.1	10.7	1.5	
TW-107	6.2	3.5	3.0	2.9	1.9	
TW-108	6.4	3.5	3.0	2.0	1.2	
TW-109	17.0	9.3	6.7	3.3	2.5	
TW-110	9.5	6.0	3.7	1.5	1.0	
TW-111	6.0	3.4	2.7	2.5	1.0	
TW-113	6.0	3.55	3.0	1.6	1.3	
TW-115	6.3	3.5	3.0	2.6	2.0	
TW-123	8.2	4.65	4.05	3.6	0.5	
TW-127	6.2	3.5	3.0	4.1	2.0	
TW-131	12.0	6.6	4.2	1.9	3.8	
TW-135	13.0	7.9	6.6	2.4	1.7	
TW-136	6.2	3.55	3.0	0.6	1.2	
TW-143	6.3	3.9	3.2	1.5	2.5	
TW-145	12.0	8.0	3.0	3.0	1.4	
TW-146	14.0	8.1	3.1	1.8	2.5	
TW-148	7.6	3.9	3.1	4.0	2.0	
TW-149	6.2	4.1	3.2	2.0	1.0	
TW-150	7.6	3.5	3.1	4.0	2.0	
TW-151	6.1	3.5	3.0	2.25	2.0	
TW-153	6.1	3.5	3.0	0.8	2.0	
TW-156	6.0	3.5	3.0	0.9	1.3	
TW-157	6.2	3.5	3.0	4.6	2.0	
TW-159	25.0	10.0	8.2	12.0	4.5	
TW-160	4.0	2.7	2.1	0.7	0.8	
TW-161	6.5	4.25	3.2	4.0	3.0	
TW-162	13.0	6.5	4.5	8.0	5.0	
TW-163	24.0	11.2	9.0	3.0	1.1	
TW-164	6.6	3.5	2.5	11.0	5.0	
TW-165	12.0	7.6	6.1	16.5	2.0	
TW-168	6.2	3.5	3.0	2.0	1.9	
TW-169	14.0	8.6	7.95	5.0	2.0	
TW-171	13.0	7.9	6.6	6.4	1.7	
TW-172	10.36	6.1	5.59	4.75	1.57	
TW-173	6.0	4.2	3.2	3.5	0.6	
TW-175	10.0	6.3	4.2	10.5	7.0	
TW-176	10.0	6.3	4.2	15.5	7.0	
TW-177	11.0	8.2	5.5	15.0	2.0	
TW-179	14.0	7.6	5.2	2.0	3.0	
TW-182	6.0	3.8	3.2	1.1	2.9	
TW-185	6.0	3.5	2.5	5.2	3.1	
TW-186	6.0	3.5	2.5	8.6	3.1	
TW-188	15.75	10.0	6.5	19.0	3.0	
TW-189	15.75	10.0	6.5	39.0	3.0	
TW-192	6.2	4.3	3.1	2.0	1.0	
TW-194	5.0	3.6	2.95	4.8	1.2	
TW-198	8.7	5.4	4.6	6.5	2.0	
TW-199	8.1	3.6	2.95	2.5	1.3	



- Material: PBT/PC V-2/PC V-0/POM/
PPS/N46 V-0/N6 V-2/
N66 V-2/N66 V-0
- Color: Natural/Black
- Unit: mm

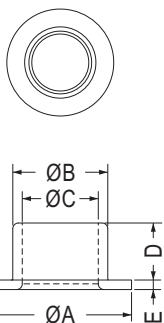
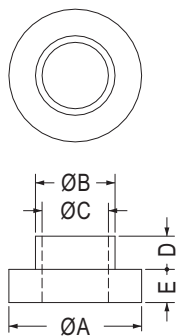

【 TW-211, TW-212 】

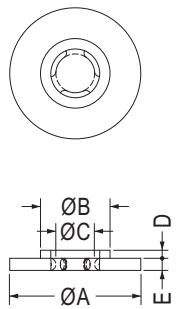

【 TW-214 】

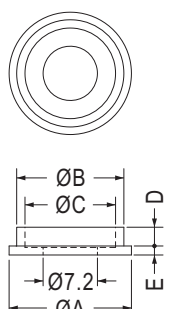

【 TW-238 】

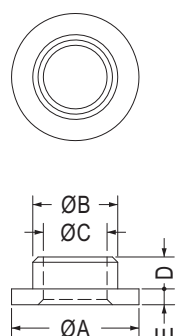

【 TW-239 】

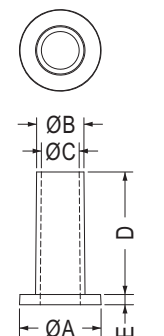

【 TW-240 】

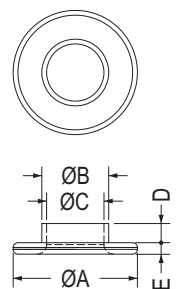

【 TW-288 】

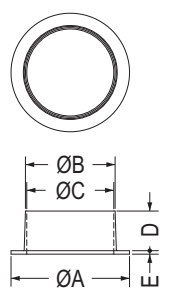

【 TW-289 】

Part No.	A	B	C	D	E	Package	
TW-202	4.8	3.0	2.6	3.5	1.2	2000	
TW-203	3.0	2.0	0.9	3.5	0.5		
TW-204	6.2	3.55	2.95	8.0	2.2		
TW-207	11.0	6.2	5.0	4.9	1.0		
TW-208	11.1	6.35	5.1	6.35	7.9		
TW-209	8.0	4.25	3.2	3.0	2.0		
TW-211	15.0	10.0	8.0	6.0	1.0		
TW-212	9.0	5.0	4.2	3.0	1.0		
TW-213	6.5	5.4	5.1	2.5	1.0		
TW-214	13.0	6.0	3.85	0.8	1.2		
TW-215	9.0	6.0	4.0	6.3	2.0		
TW-219	4.6	3.0	2.3	1.6	1.2		
TW-222	3.0	1.8	0.9	1.0	0.5		
TW-223	6.0	3.1	2.6	1.5	1.0		
TW-224	20.0	11.9	6.5	2.5	3.0	1000	
TW-225	11.0	8.0	5.5	8.0	3.0	2000	
TW-226	4.2	3.0	2.6	1.0	2.25		
TW-227	23.7	13.0	10.0	13.0	2.0	500	
TW-228	23.7	13.0	10.0	23.0	2.0	1000	
TW-229	20.0	11.0	8.1	8.0	2.0		
TW-230	20.0	11.0	8.1	13.0	2.0	500	
TW-234	8.0	4.4	3.2	0.9	2.0	2000	
TW-235	13.0	7.9	6.6	1.6	1.7		
TW-237	13.0	9.8	4.5	10.3	2.0	1000	
TW-238	16.2	14.2	12.0	2.49	1.19	2000	
TW-239	2.4	1.6	1.2	0.6	0.3		
TW-240	8.0	4.65	3.7	12.0	1.0		
TW-242	6.1	3.55	3.0	1.5	0.9		
TW-243	10.5	9.5	8.0	0.7	1.0		
TW-245	11.5	7.5	6.7	2.0	1.0		
TW-246	15.0	7.9	4.2	2.0	1.5		
TW-249	8.5	5.75	5.2	3.0	1.2		
TW-250	8.7	5.2	4.4	0.8	1.6		
TW-252	16.0	8.0	5.0	1.55	0.85		
TW-253	22.0	16.0	10.5	4.5	1.5		1000
TW-256	8.7	5.2	4.4	4.7	1.6		2000
TW-257	12.0	9.0	6.0	6.0	2.0		
TW-258	20.0	12.0	8.0	10.0	3.0	1000	
TW-259	20.0	12.0	8.0	7.0	2.0		
TW-260	10.0	7.0	5.0	10.0	1.0	2000	
TW-261	20.0	10.0	8.0	3.0	3.0	1000	
TW-262	20.0	12.0	10.0	2.0	3.0		
TW-263	25.0	12.0	10.0	5.0	1.0		
TW-264	18.0	16.0	12.0	9.0	1.0		
TW-266	15.0	7.9	6.2	2.0	2.0	2000	
TW-268	15.0	9.9	8.2	2.0	1.5		
TW-270	20.0	10.0	8.0	12.0	3.0	1000	
TW-273	15.0	8.9	6.2	3.0	1.5	2000	
TW-274	16.0	12.0	10.0	4.0	2.0		
TW-275	10.0	7.0	5.0	2.0	1.0	1000	
TW-276	26.0	16.0	14.0	5.0	5.0		
TW-278	12.0	8.0	5.0	7.0	2.0	2000	
TW-279	12.0	6.0	4.0	15.0	2.0	1000	
TW-282	12.0	8.0	6.0	3.0	1.0	2000	
TW-283	14.0	8.0	6.0	3.0	3.0		
TW-284	16.0	12.0	10.0	3.0	1.0		
TW-287	16.0	8.0	6.0	6.0	5.0		
TW-288	13.0	7.0	6.0	2.0	1.2		
TW-289	27.5	20.8	20.2	9.2	0.8		1000
TW-291	12.0	7.0	5.0	6.0	2.0	2000	
TW-292	5.5	3.5	3.0	2.6	0.6		

電晶體墊片 TRANSISTOR WASHER

用途：鎖於電晶體上，避免晶體外殼與散熱片間造成短路。



- Material: PBT/PC V-2/PC V-0/POM/PPS/N46 V-0/N6 V-2/N66 V-2/N66 V-0
- Color: Natural/Black
- Unit: mm

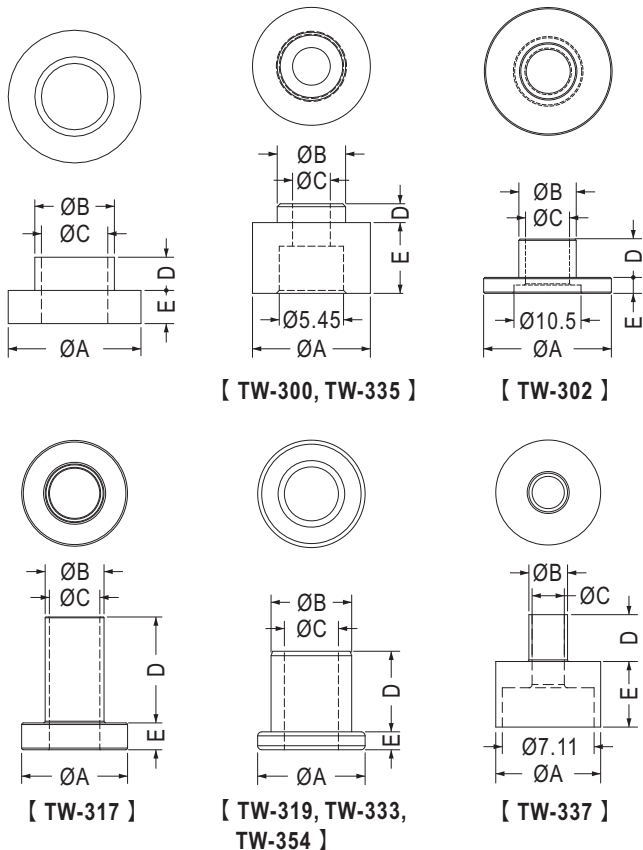

Part No.	A	B	C	D	E	Package
TW-300	10.0	5.8	3.2	1.6	6.0	2000
TW-301	19.0	9.4	8.2	1.7	0.8	1000
TW-302	20.0	9.0	6.9	6.0	2.5	
TW-304	7.4	4.3	3.6	1.6	1.2	
TW-308	6.0	3.7	2.9	6.4	1.2	2000
TW-311	7.9	4.5	3.65	6.0	1.2	
TW-313	20.0	11.0	8.0	4.0	2.0	1000
TW-317	6.3	3.5	3.0	6.3	1.6	
TW-319	12.0	9.0	6.0	9.0	2.0	
TW-321	12.0	7.9	4.2	6.0	2.2	
TW-322	20.7	7.6	6.0	7.7	0.8	
TW-323	6.35	4.75	3.66	0.81	1.57	
TW-324	7.92	4.75	3.66	0.81	1.57	2000
TW-328	6.1	3.5	2.9	1.6	2.4	
TW-329	11.5	7.5	5.5	8.0	1.0	
TW-330	8.7	5.2	4.4	3.2	1.6	
TW-331	10.0	3.9	3.1	1.7	1.3	
TW-332	6.3	3.5	3.0	7.3	1.6	
TW-333	12.0	9.0	6.0	8.0	2.0	1000
TW-335	8.7	5.2	4.4	6.4	1.6	
TW-336	6.0	3.7	2.9	9.5	1.2	
TW-337	8.13	3.0	2.5	3.63	5.08	
TW-339	6.4	4.7	3.0	1.3	0.8	
TW-340	8.7	5.2	4.4	1.6	1.6	
TW-341	9.5	7.9	6.4	1.5	0.8	
TW-342	12.5	7.92	6.6	1.98	0.81	
TW-343	10.15	6.6	5.1	6.35	3.2	2000
TW-345	15.0	8.9	4.2	2.0	1.5	
TW-346	10.0	3.9	2.6	1.7	1.3	
TW-347	18.0	10.9	10.2	2.5	1.5	
TW-350	6.0	3.3	2.1	1.5	1.0	
★TW-351	7.4	4.3	3.6	6.4	1.2	
★TW-352	18.0	11.9	6.2	2.5	1.5	
★TW-353	10.0	4.9	3.1	1.7	1.3	
★TW-354	12.0	9.0	6.0	4.0	2.0	

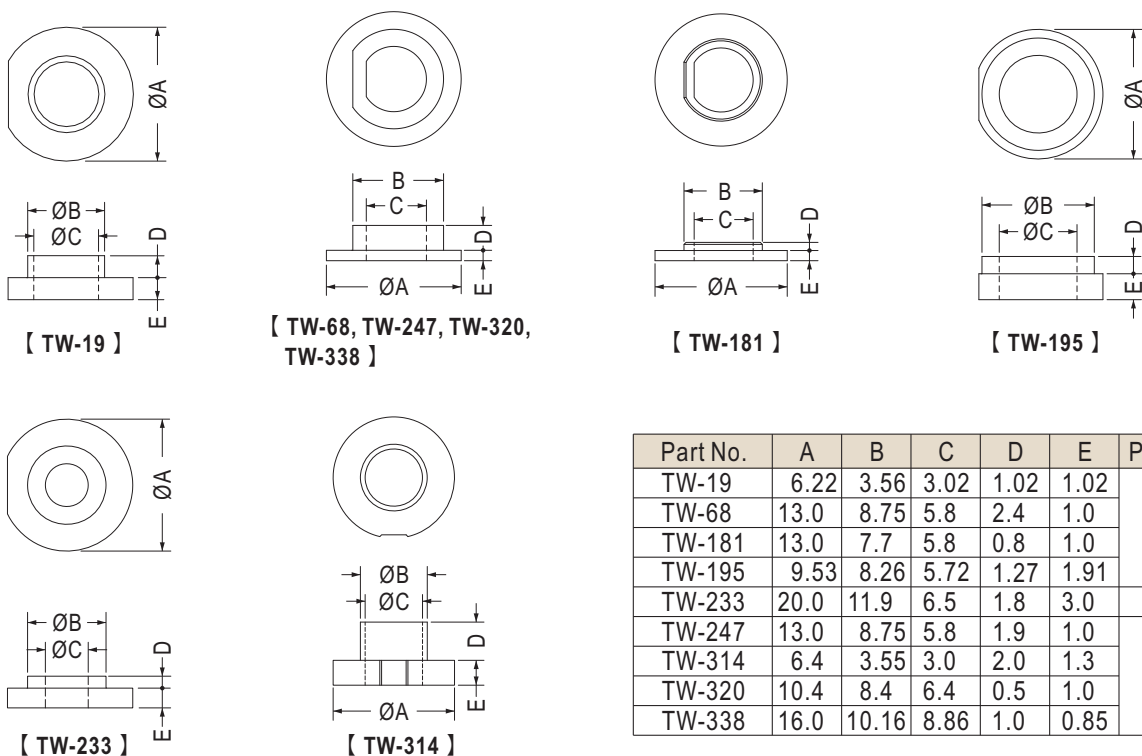

Part No.	A	B	C	D	E	Package
TW-19	6.22	3.56	3.02	1.02	1.02	
TW-68	13.0	8.75	5.8	2.4	1.0	2000
TW-181	13.0	7.7	5.8	0.8	1.0	
TW-195	9.53	8.26	5.72	1.27	1.91	
TW-233	20.0	11.9	6.5	1.8	3.0	1000
TW-247	13.0	8.75	5.8	1.9	1.0	
TW-314	6.4	3.55	3.0	2.0	1.3	2000
TW-320	10.4	8.4	6.4	0.5	1.0	
TW-338	16.0	10.16	8.86	1.0	0.85	

電晶體墊片 TRANSISTOR WASHER

用途：鎖於電晶體上，避免晶體外殼與散熱片間造成短路。



- Material: PPS (UL)
- Flame Class: 94V-0
- Color: Natural(Brown)/Black
- Unit: mm

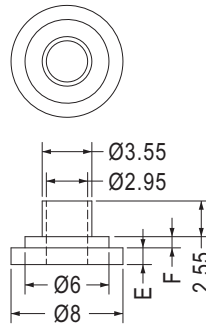

Part No.	E	F	Package
TW-147	1.2	0.8	2000
TW-297	1.0	1.6	

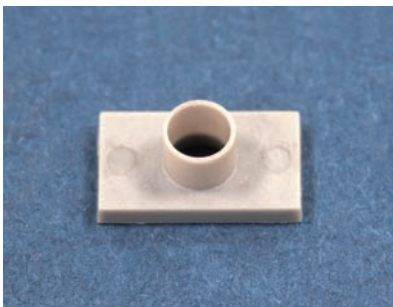

- Material: PET
- Color: Gray
- Unit: mm

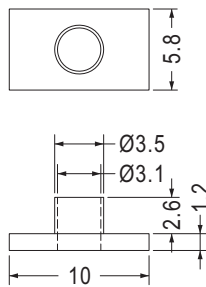

Part No.	Package
TW-241	1000



- Material: PPS (UL)
- Flame Class: 94V-0
- Color: Black
- Unit: mm

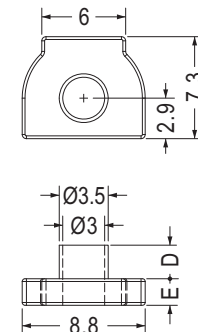

Part No.	D	E	Package
TW-298	2.4	1.9	1000
TW-299	1.6	1.3	

絕緣柱 ROUND SPACER

用途：用於零件之絕緣使用。



- Material: Nylon 66 (UL)
- Flame Class: 94V-2/94V-0
- Color: Natural/Black
- Unit: mm

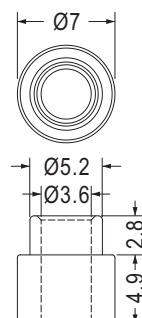

Part No.	Package
TW-133	2000

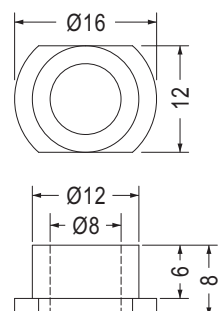

Part No.	Package
TW-125	1000

零件墊片 WASHER

用途：做為零件之墊片。



- Material: Nylon 66 (UL)
- Flame Class: 94V-2/94V-0
- Color: Natural/Black
- Unit: mm

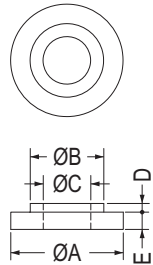

Part No.	A	B	C	D	E	Package
TWC-7	7.6	5.84	3.25	1.27	0.38	2000
TWC-12	19.2	9.4	6.5	0.8	1.2	
TWC-13	15.0	10.0	5.5	1.2	2.5	
TWC-16	15.0	9.9	4.2	2.0	1.5	
TWC-21	9.52	6.35	4.32	0.81	0.81	
★TWC-22	25.0	13.8	12.2	2.0	2.0	1000
★TWC-23	10.0	5.9	5.2	1.7	1.3	2000
★TWC-24	25.0	15.8	14.2	2.0	2.0	1000
★TWC-25	25.0	17.8	16.2	2.0	2.0	
★TWC-26	25.0	15.8	12.2	2.0	2.0	
★TWC-27	15.0	6.9	3.1	2.0	1.5	2000
★TWC-28	15.0	8.9	6.2	2.0	1.5	
★TWC-29	9.52	7.82	4.98	0.81	1.57	

- Material: PC+ABS(UL)

Part No.	A	B	C	D	E	Package
TWC-3	13.0	8.5	5.5	1.0	2.0	2000
TWC-5	13.0	8.5	5.5	1.0	7.0	
TWC-6	14.6	10.1	4.5	0.4	1.9	

Part No.	A	B	C	D	E	Package
FUG-1	16.8	12.5	9.5	2.0	2.0	1000
FUG-3	11.1	7.9	6.4	0.81	0.81	

電晶體墊片 TRANSISTOR WASHER

用途：用於零件之絕緣使用。

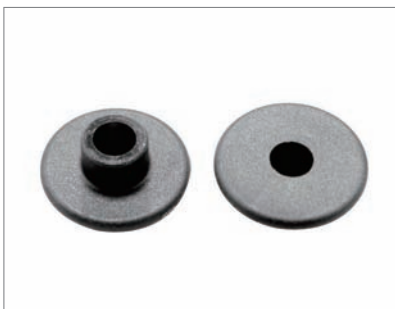

- Material: PC
- Color: Black
- Unit: mm

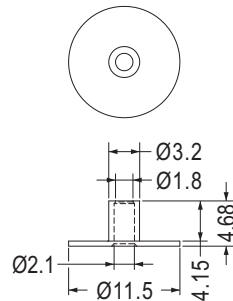

Part No.	Package
TW-210	1000

- Material: Nylon 66 (UL)
- Flame Class: 94V-2/94V-0
- Color: Natural/Black
- Unit: mm

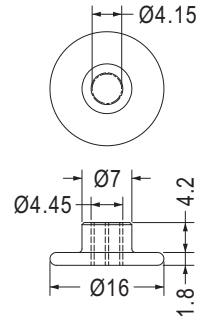

Part No.	Package
TW-178	1000



- Material: Nylon 46 (UL)/PPS (UL)
- Flame Class: 94V-0
- Color: Natural/Black
- Unit: mm

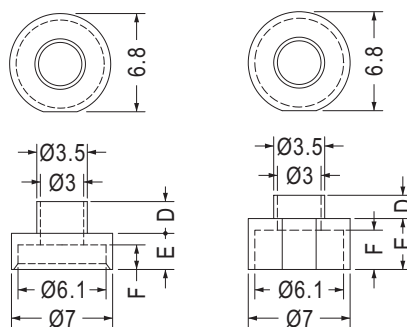

【 TW-124 】

用途：鎖於電晶體上，避免晶體外殼與散熱片間造成短路。

Part No.	D	E	F	Package
TW-71	2.4	6.5	4.6	2000
TW-92	1.6	3.5	2.7	
TW-93	2.2	3.8	3.0	
TW-98	1.6	3.5	2.1	
TW-103	2.4	3.9	2.0	
TW-114	1.6	5.0	4.2	
TW-118	2.4	4.9	3.0	
TW-119	1.6	3.8	3.0	
TW-120	1.6	2.8	2.0	
TW-124	2.2	2.5	1.7	
TW-201	3.2	5.0	4.2	
TW-309	2.8	4.2	3.4	

電晶體墊片 TRANSISTOR WASHER



- Material: PPS (UL)
- Flame Class: 94V-0
- Color: Natural(Brown)
- Unit: mm

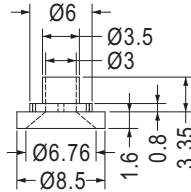

Part No.	Package
TW-180	2000

用途：鎖於電晶體上，避免晶體外殼與散熱片間造成短路。

- Material: Nylon 6T (UL)
- Flame Class: 94V-0
- Color: Natural

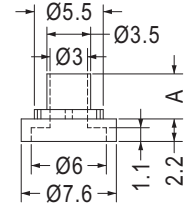

Part No.	A	Package
TW-236	3.6	2000
TW-277	4.2	



- Material: POM
- Color: Black
- Unit: mm

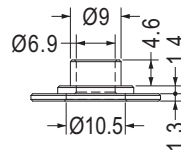

Part No.	Package
TW-312	1000

絕緣柱 ROUND SPACER

用途：用於螺絲之絕緣使用。



- Material: Nylon 46 (UL)/PPS (UL)
- Flame Class: 94V-0
- Color: Natural
- Unit: mm

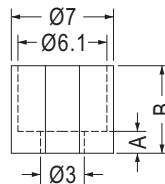

Part No.	A	B	Package
UT-1	1.5	6.0	2000
UT-3	1.4	3.5	
UT-5	0.8	3.8	
UT-6	0.3	2.3	
UT-12	0.3	2.3	
UT-13	0.3	1.9	

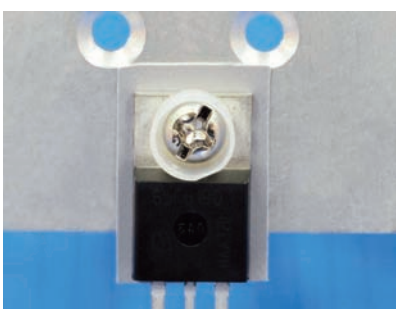

- Material: Nylon 46 (UL)
- Flame Class: 94V-0
- Color: Natural
- Unit: mm

用途：用於M3螺絲或螺母之絕緣使用。

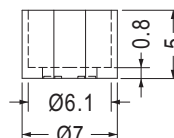
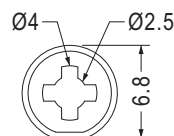

Part No.	Package
UT-17	1000

絕緣柱 ROUND SPACER

用途：用於M3螺母之絕緣使用。

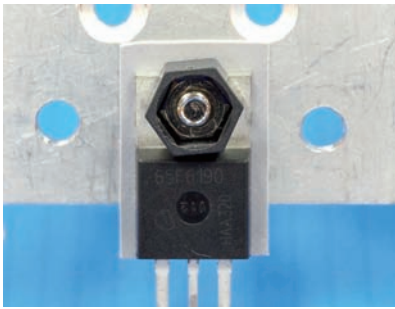

- Material: Nylon 46 (UL)
- Flame Class: 94V-0
- Color: Natural
- Unit: mm

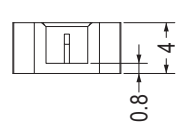
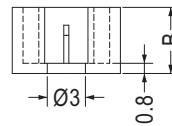
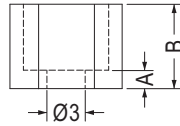
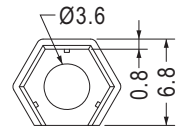
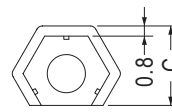
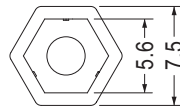

Part No.	Material	A	B	Package
UT-2	Nylon 46	1.5	6.4	2000
UT-8	PPS	0.8	5.2	

Part No.	B	C	Package
UT-4	5.2	6.25	2000
UT-7	4.0	5.8	
UT-11	4.0	6.25	

Part No.	Package
UT-19	2000

電晶體墊片 TRANSISTOR WASHER

用途：鎖於電晶體上，避免晶體外殼與散熱片間造成短路。



- Material: Nylon 46 (UL)
- Flame Class: 94V-0
- Color: Natural
- Unit: mm

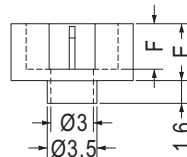
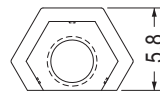

Part No.	E	F	Package
TW-190	4.0	3.2	2000
TW-191	5.0	4.2	

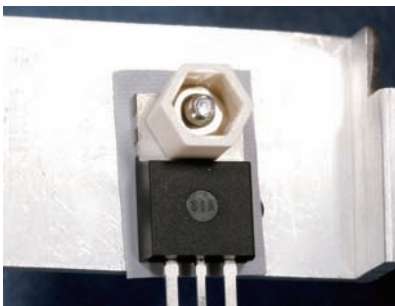

- Material: Nylon 66 (UL)
- Flame Class: 94V-2/94V-0
- Color: Natural/Black
- Unit: mm

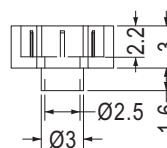

Part No.	Package
TW-290	2000

- Material: Nylon 46 (UL)/PPS (UL)
- Flame Class: 94V-0
- Color: Natural/Black
- Unit: mm

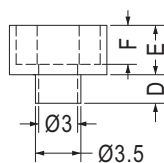
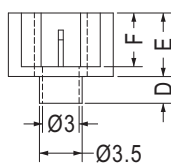
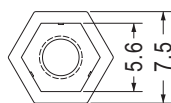

【 TW-285 】

Part No.	D	E	F	Package
TW-72	1.6	6.4	5.0	2000
TW-94	1.6	5.0	4.2	
TW-95	2.2	5.2	4.4	
TW-112	1.6	4.0	3.2	
TW-121	2.4	6.3	4.4	
TW-122	1.6	5.2	4.4	
TW-248	1.6	3.4	2.6	
TW-285	2.2	3.8	3.0	

絕緣柱 ROUND SPACER



- Material: PC (UL)
- Flame Class: 94V-2
- Color: Natural
- Unit: mm

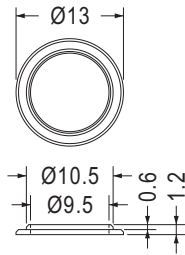

Part No.	Package
UPD-1	1000

用途：用於零件之絕緣使用。

- Material: Nylon 66 (UL)
- Flame Class: 94V-2/94V-0
- Color: Natural/Black
- Unit: mm

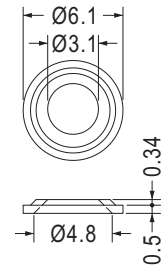

Part No.	Package
TWC-2	2000

零件墊片 WASHER



- Material: Nylon 66 (UL)
- Flame Class: 94V-2/94V-0
- Color: Natural/Black
- Unit: mm

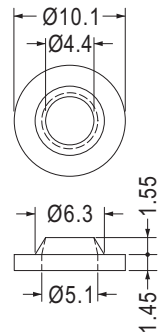

Part No.	Package
TWC-1	2000

用途：做為零件之墊片。

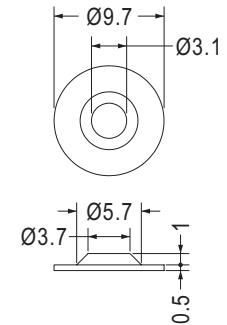

Part No.	Package
TWC-19	1000

6



- Material: PPS (UL)
- Flame Class: 94V-0
- Color: Natural(Brown)/Black
- Unit: mm

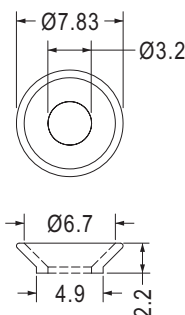

Part No.	Package
TWC-15	2000

- Material: Nylon 66 (UL)
- Flame Class: 94V-2/94V-0
- Color: Natural/Black
- Unit: mm

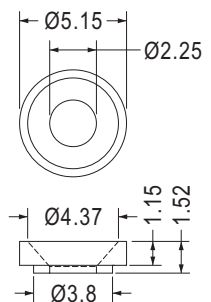

Part No.	Package
TWC-8	1000

華司 WASHER

用途：做為螺絲之墊片。

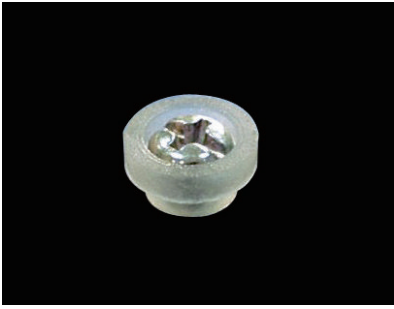

- Material: PC (UL)
- Flame Class: 94V-2/94V-0
- Color: Natural
- Unit: mm

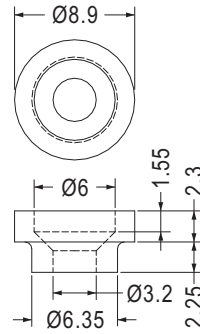

Part No.	Package
WSF-3	2000

零件墊片 WASHER

用途：做為零件之墊片。



- Material: Nylon 66 (UL)
- Flame Class: 94V-2/94V-0
- Color: Natural/Black
- Unit: mm

- Material: PC+ABS (UL)
- Flame Class: 94V-2/94V-0
- Color: Natural/Black
- Unit: mm

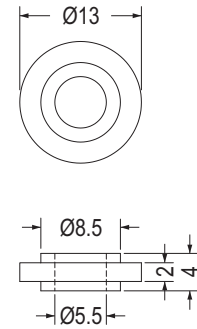
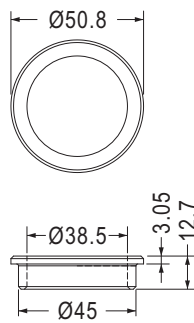

Part No.	Package
TWC-14	1000

Part No.	Package
TWC-4	2000



- Material: Nylon 66 (UL)
- Flame Class: 94V-2/94V-0
- Color: Natural/Black
- Unit: mm

用途：螺絲墊片，耐熱性良好。

- Material: POM (UL)
- Flame Class: 94HB

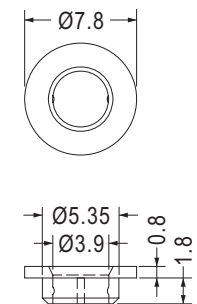
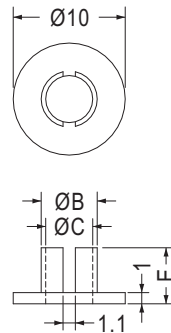

• 可配合M4螺絲

Part No.	B	C	E	Package
TWU-1	5.0	4.2	5.0	2000
TWU-3	6.0	5.0	6.0	

Part No.	Package
TWU-2	2000

絕緣柱 ROUND SPACER

用途：用於零件之絕緣使用。



- Material: Nylon 66 (UL)
- Flame Class: 94V-2/94V-0
- Color: Natural/Black
- Unit: mm

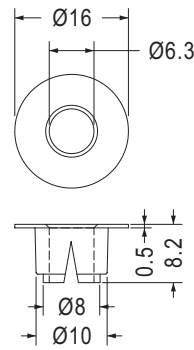

Part No.	Package
GLIN-10	1000

滾輪 ROLLER

用途：用於機櫃當滾輪使用。



- Material: PC (UL)/PBT (UL)/POM/
Nylon 66 (UL)
- Flame Class: 94V-2/94V-0
- Color: Black
- Unit: mm

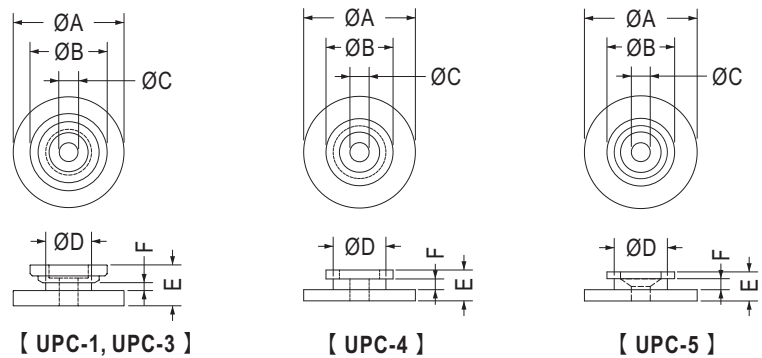

Part No.	Material	A	B	C	D	E	F	Package
UPC-1	PC	25.4	17.67	4.3	11.07	9.36	1.79	1000
UPC-3		25.4	17.7	4.3	11.0	9.4	1.95	
UPC-4	PBT	25.0	15.0	4.3	11.8	6.9	2.4	
	POM	24.2	14.7	4.1	11.4	6.6	2.4	
UPC-5	NYLON 66	25.0	15.0	4.2	11.8	6.45	2.45	

零件墊片 WASHER

用途：做為零件之墊片。



- Material: Nylon 66 (UL)
- Flame Class: 94V-2/94V-0
- Color: Natural/Black
- Unit: mm

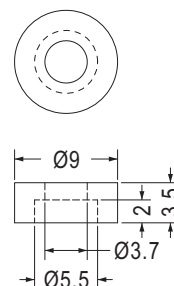

Part No.	Package
TWC-17	2000

絕緣柱 SPACER SUPPORT

用途：做為PC板與機板之絕緣用。



- Material: Nylon 66 (UL)/
Nylon 6 (UL)/PC (UL)
- Flame Class: 94V-2/94V-0
- Color: Natural/Black
- Unit: mm

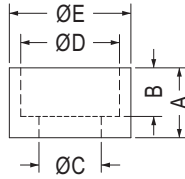

Part No.	A	B	C	D	E	Package
U-4	4.9	3.8	3.2	5.7	7.0	2000
U-5	4.6	3.2	4.1	6.5	8.0	
U-6	10.0	7.0	3.0	8.5	11.0	1000
U-7	3.1	2.1	3.0	5.5	7.5	2000
U-8	3.0	1.5	3.7	7.4	9.4	
U-10	4.6	3.6	3.6	7.6	9.1	
U-11	4.0	3.0	2.9	6.3	7.8	
U-12	4.2	2.7	3.2	5.3	8.74	
U-14	6.5	6.0	6.0	8.0	9.0	
U-15	7.1	5.1	4.8	8.9	15.7	
U-16	5.1	4.0	7.0	10.0	12.0	
U-17	3.8	3.05	3.2	5.4	7.0	
U-18	6.4	3.4	3.2	5.0	7.0	
U-19	6.0	3.0	2.8	5.1	7.5	
U-23	3.8	2.25	3.4	5.95	8.0	
U-25	4.8	2.5	6.8	4.5	12.5	
U-27	4.5	3.75	3.1	4.2	6.0	
U-28	4.8	3.3	3.4	6.5	9.5	
U-29	6.5	6.0	3.5	6.0	8.0	
U-30	3.75	2.65	3.2	5.4	7.0	
U-31	2.3	1.7	3.25	5.5	6.7	
U-33	5.0	4.6		4.5	5.2	
U-37	2.5	2.0	3.5	6.0	7.0	
U-39	5.1	4.0	3.2	10.0	12.0	
U-40	3.5	3.0		6.8	8.7	
U-42	20.0	17.5	5.2	14.0	17.0	500

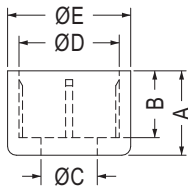
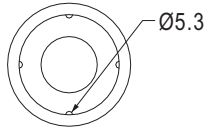

【 U-4 】

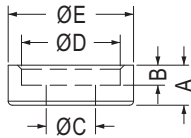
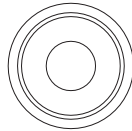

【 U-8, U-12, U-23 】

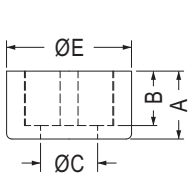
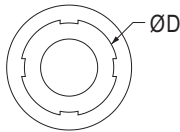

【 U-17, U-18, U-19 】

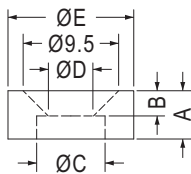
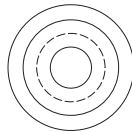

【 U-25 】

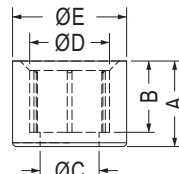
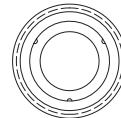

【 U-27 】

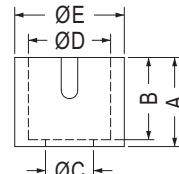
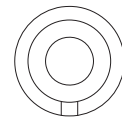

【 U-29 】

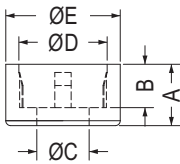
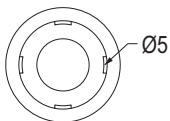

【 U-30 】

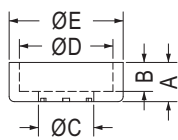
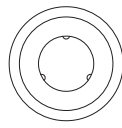

【 U-31 】

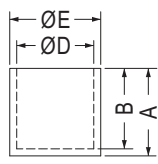

【 U-33 】

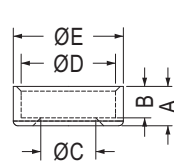
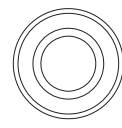

【 U-37 】

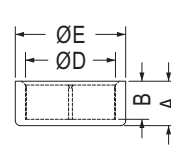
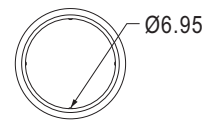

【 U-40 】



- Material: Nylon 46 (UL)/PPS (UL)
- Flame Class: 94V-0
- Color: Natural/Black
- Unit: mm

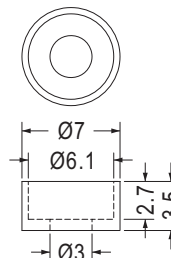

Part No.	Package
UT-14	2000

絕緣柱 ROUND SPACER

用途：用於零件之絕緣使用。



- Material: Nylon 66 (UL)
- Flame Class: 94V-2/94V-0
- Color: Natural/Black
- Unit: mm

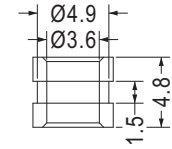
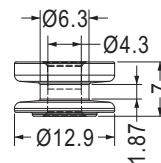
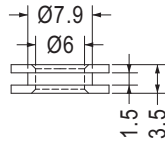
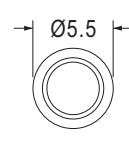
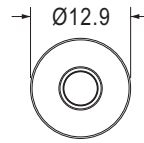
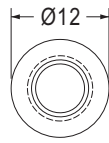

- Material: POM

Part No.	Package
UPA-1	1000

Part No.	Package
UPA-2	1000

Part No.	Package
UPA-4	1000

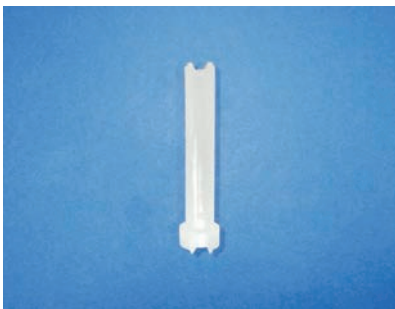

- Material: PC (UL)
- Flame Class: 94V-2/94V-0
- Color: Transparent
- Unit: mm

用途：做為PC板與機板之絕緣用。

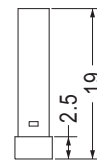
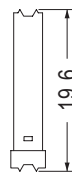
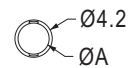
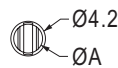

Part No.	A	Package
EM-580	3.5	1000
EM-582	3.0	

Part No.	A	Package
EM-581	3.5	1000
EM-583	3.0	

電晶體墊片 TRANSISTOR WASHER

用途：保護TO-05晶體立於PC板上，使接腳不彎曲、折斷、短路，且高度一致，增加可靠度。

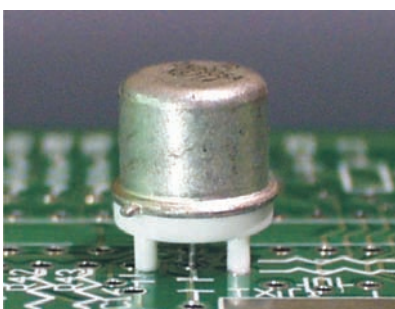

- Material: Nylon 66 (UL)/PBT (UL)
- Flame Class: 94V-2/94V-0
- Color: Natural/Black
- Unit: mm

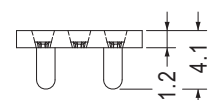
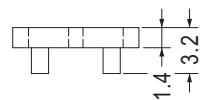
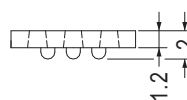
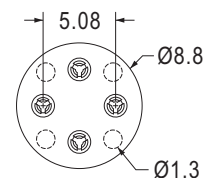
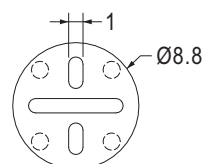
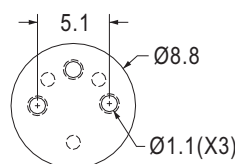

Part No.	Package
TO-05S	2000

Part No.	Package
TO-05	1000

Part No.	Package
TO-05C	1000

電晶體墊片 TRANSISTOR WASHER

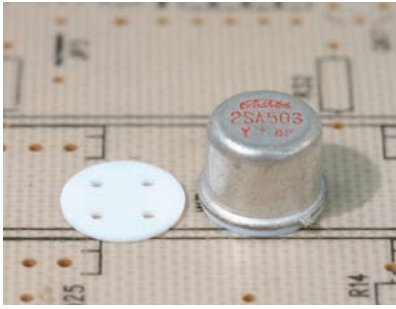

- Material: Nylon 66 (UL)
- Flame Class: 94V-2/94V-0
- Color: Natural/Black
- Unit: mm

用途：保護TO-05晶體立於PC板上，且高度一致，不斷腳。

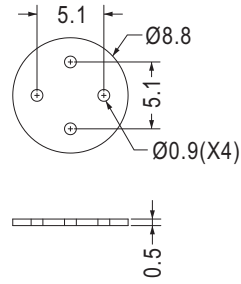

Part No.	Package
TO-05-1	1000



- Material: Nylon 66 (UL)/PBT (UL)
- Flame Class: 94V-2/94V-0
- Color: Natural/Black
- Unit: mm

用途：保護TO-18晶體立於PC板上，使接腳不彎曲、折斷、短路，且高度一致，增加可靠度。

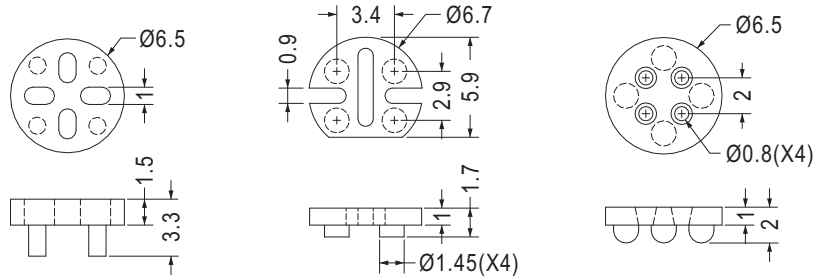

Part No.	Package
TO-18	1000

Part No.	Package
TO-18S	1000

Part No.	Package
TO-18M	2000



- Material: Nylon 66 (UL)
- Flame Class: 94V-2/94V-0
- Color: Natural/Black
- Unit: mm

用途：保護TO-92功率晶體立於PC板上，高度一致，不斷腳。

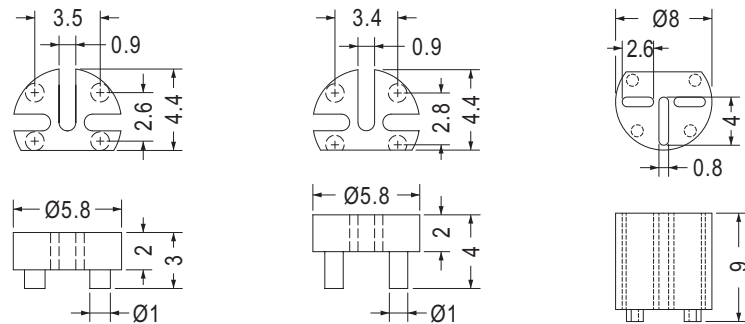

Part No.	Package
TO-92	2000

Part No.	Package
TO-92-4	2000

Part No.	Package
TO-92-9	1000

電晶體座 TRANSISTOR HOUSING



- Material: Nylon 66 (UL)
- Flame Class: 94V-2/94V-0
- Color: Natural/Black
- Unit: mm

用途：保護TO-92功率晶體立於PC板上，使接腳不彎曲、折斷、短路，且高度一致。

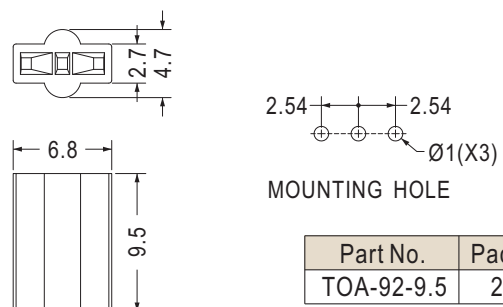

Part No.	Package
TOA-92-9.5	2000

電晶體墊片 TRANSISTOR WASHER

用途：用於橋式整流器或電晶體之墊高。

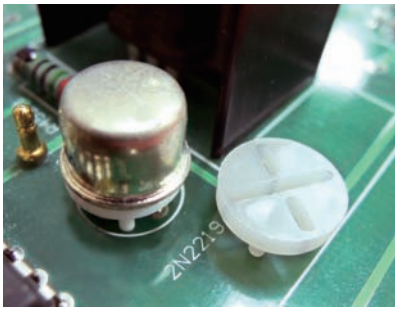

- Material: Nylon 66 (UL)
- Flame Class: 94V-2/94V-0
- Color: Natural/Black
- Unit: mm

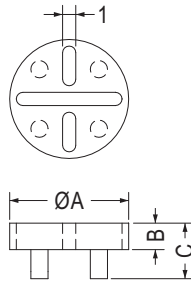

Part No.	A	B	C	Package
BW-1	9.0	2.0	4.2	2000
BW-2	14.0	1.0	2.1	

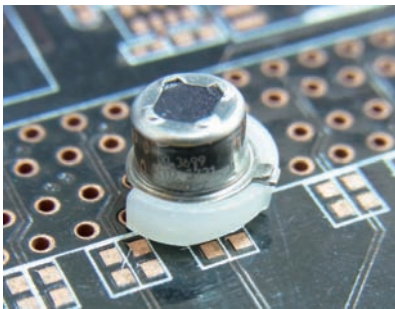

- Material: Nylon 66 (UL)
- Flame Class: 94V-2/94V-0
- Color: Natural/Black
- Unit: mm

用途：保護晶體立於PC板上，使接腳不彎曲、折斷、短路，且高度一致，增加可靠度。

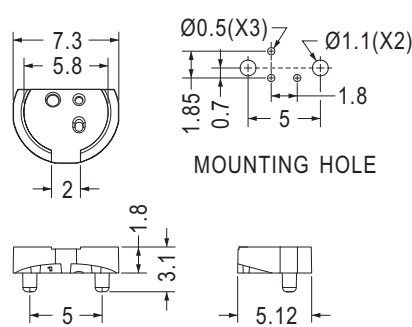

Part No.	Package
TRB-2	2000

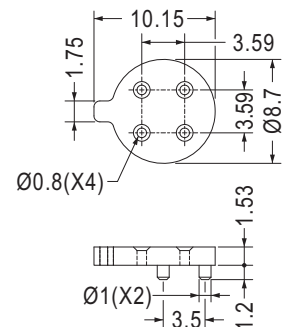

Part No.	Package
TRB-19	2000

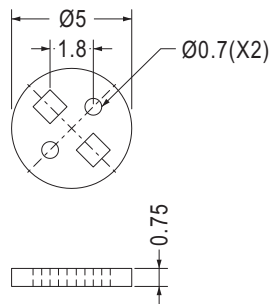

Part No.	Package
TRB-1	2000

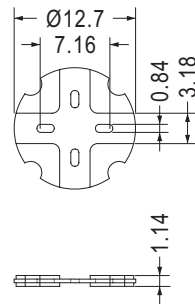

Part No.	Package
TO-5	1000

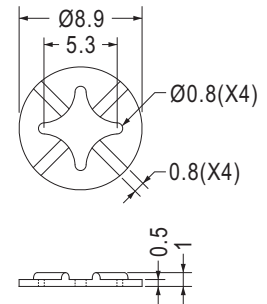

Part No.	Package
TO-5-1	1000

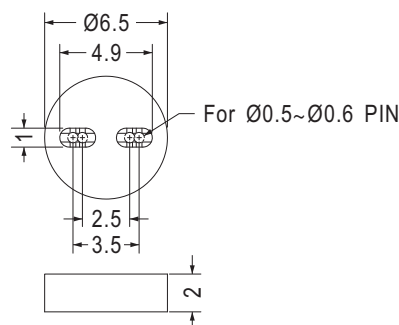
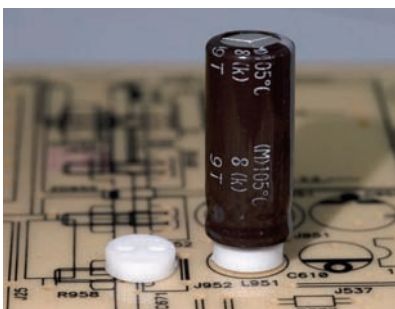

Part No.	Package
TRB-21	2000

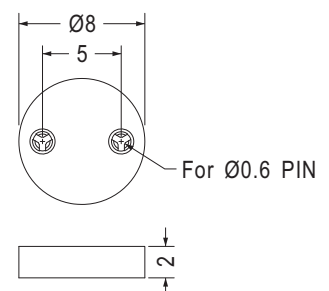

Part No.	Package
TRB-22	2000

IC座 IC HOUSING

用途：8PIN鐵殼IC之架高與絕緣。



- Material: Nylon 66 (UL)
- Flame Class: 94V-2/94V-0
- Color: Natural/Black
- Unit: mm

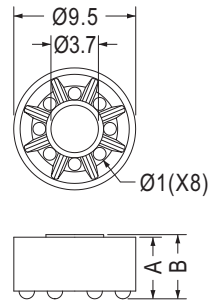

Part No.	A	B	Package
ICV-1	2.0	2.2	1000
ICV-2	4.8	5.0	

TO-3電晶體座 TRANSISTOR HOUSING

用途：鎖於TO-3功率晶體與散熱片之間，作為絕緣與保護之用。



- Material: Nylon 66 (UL)
- Flame Class: 94V-2/94V-0
- Color: Natural/Black
- Unit: mm

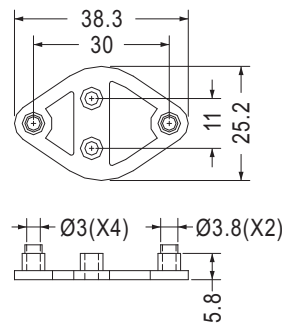

Part No.	Package
TR-4	500

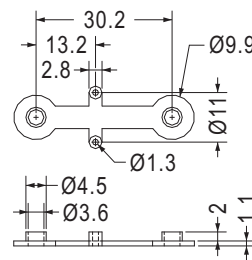

Part No.	Package
TR-6	1000

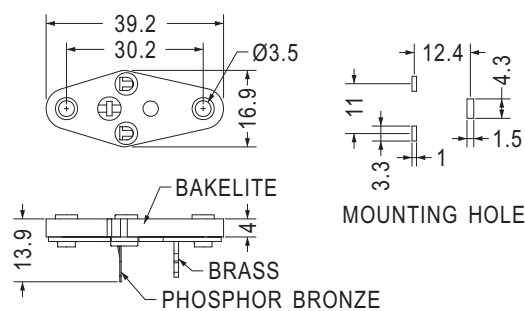

Part No.	Package
TO-3APF	1000

電晶體蓋 TRANSISTOR COVER

用途：用於TO-3功率晶體之外殼絕緣。



- Material: Nylon 66 (UL)
- Flame Class: 94V-2/94V-0
- Color: Natural/Black
- Unit: mm

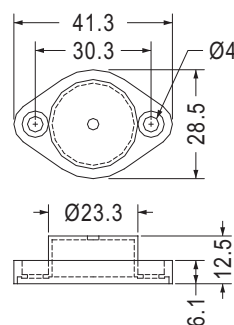

Part No.	Package
TRC-1	200



- Material: Nylon 46 (UL)
- Flame Class: 94V-0
- Color: Natural/Black
- Unit: mm

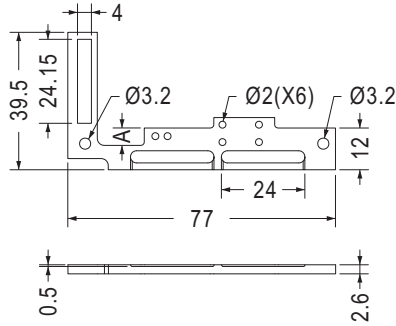

Part No.	A	Package
EM-51	5.0	500
EM-63	5.5	



- Material: Nylon 6T (UL)
- Flame Class: 94V-0
- Color: Natural/Black
- Unit: mm

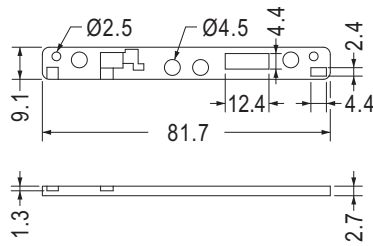

Part No.	Package
EMD-106	500

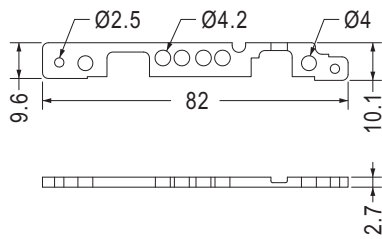

Part No.	Package
EMD-42	500

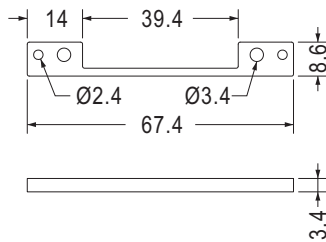

Part No.	Package
EMD-142	500

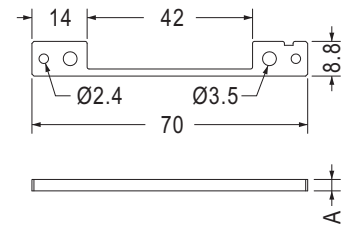

Part No.	A	Package
EMD-108	2.9	500
EMD-109	3.4	

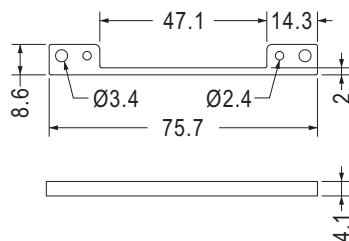

Part No.	Package
EMD-260	1000

- Material: Nylon 46 (UL)
- Flame Class: 94V-0
- Color: Natural/Black
- Unit: mm

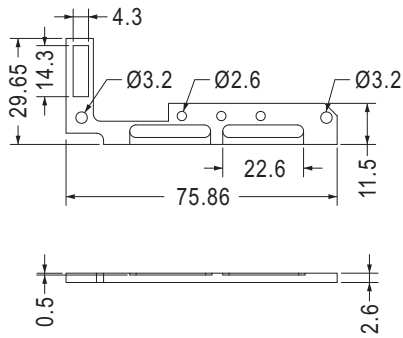

Part No.	Package
EML-7	200

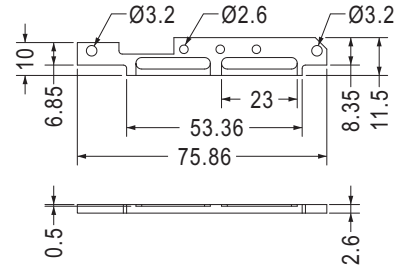

Part No.	Package
EML-10	500

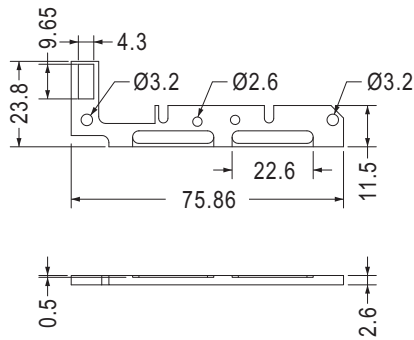
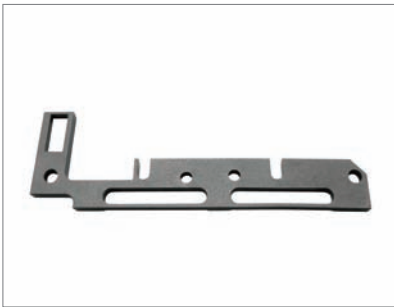

Part No.	Package
EML-13	200

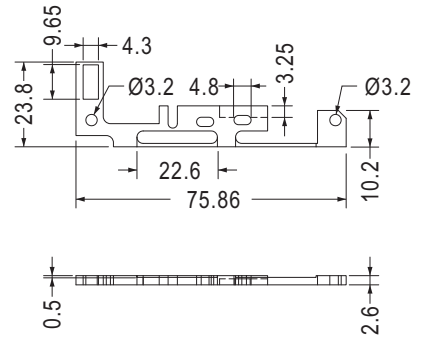

Part No.	Package
EML-23	200

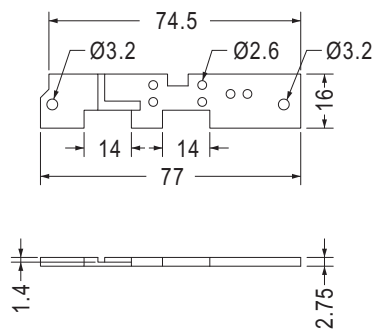

Part No.	Package
EML-22	500

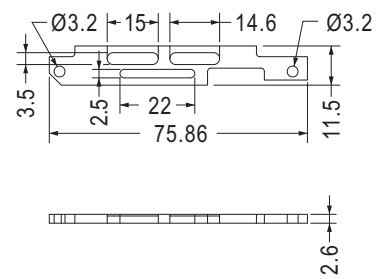

Part No.	Package
EML-52	500

零件墊座 PARTS HOUSING

用途：用於電源供應器，球擊測試的保護。

- Material: PC (UL)
- Flame Class: 94V-0
- Color: Black
- Unit: mm

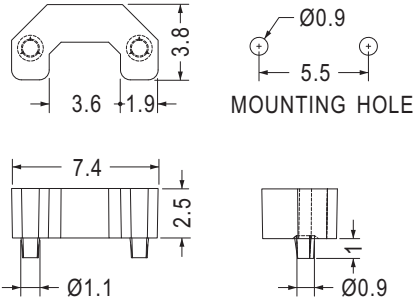

Part No.	Package
EMD-25	2000

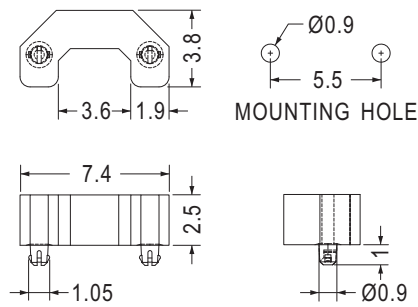

Part No.	Package
EMD-118	2000

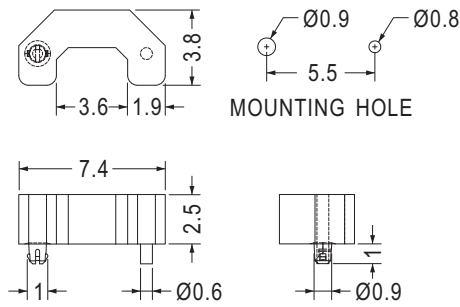

Part No.	Package
EMD-203	2000

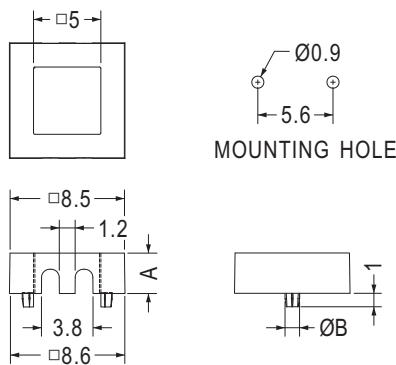

Part No.	A	B	Package
EMD-14	2.5	0.9	2000
EMD-136	3.0	1.08	

零件墊座 PARTS HOUSING

用途：用於電源供應器，球擊測試的保護。

- Material: PC (UL)
- Flame Class: 94V-0
- Color: Black
- Unit: mm

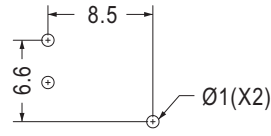
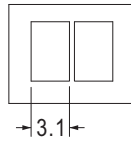
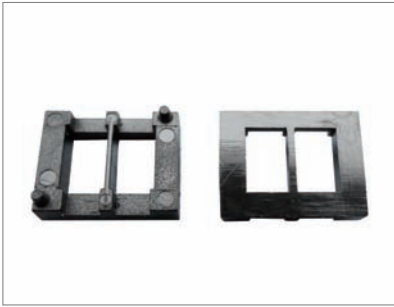

MOUNTING HOLE

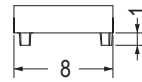
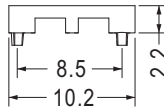

Part No.	Package
EMD-29	2000

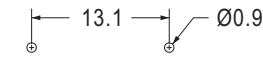
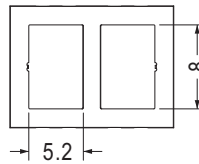
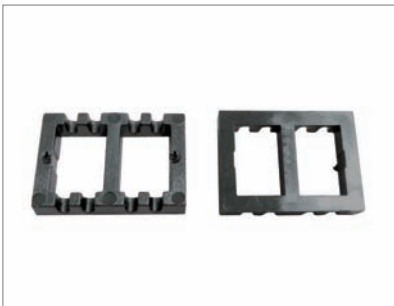

MOUNTING HOLE

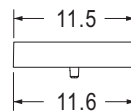
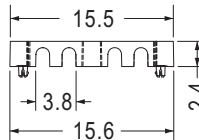

Part No.	Package
EMD-147	1000

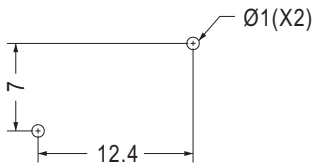
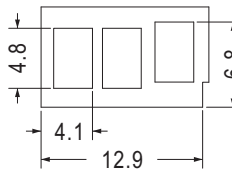

MOUNTING HOLE

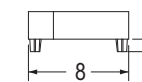
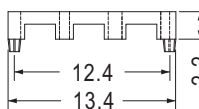

Part No.	Package
EMD-131	1000

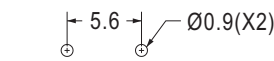
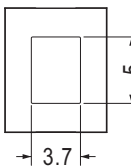

MOUNTING HOLE

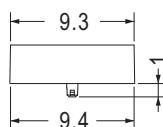
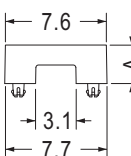

Part No.	A	Package
EMD-129	2.4	2000
EMD-140	2.9	

球擊緩衝墊片 IMPACT BUFFER PAD

用途：做為球擊測試之緩衝墊片。

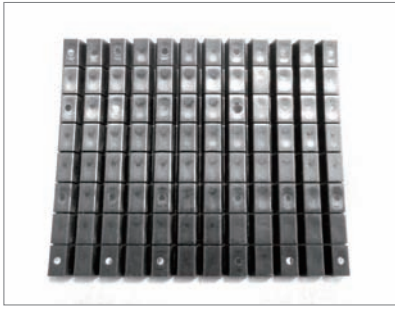

- Material: Nylon 66 (UL)
- Flame Class: 94V-2/94V-0
- Color: Black
- Unit: mm

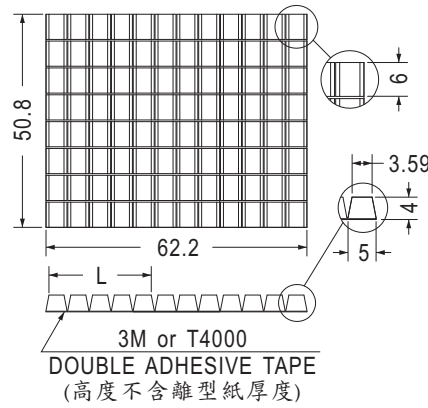

Part No.	L	Package
EMD-10-1	3.59	96PCS
EMD-10-2	8.79	
EMD-10-3	13.99	
EMD-10-4	19.19	
EMD-10-5	24.39	
EMD-10-6	29.59	

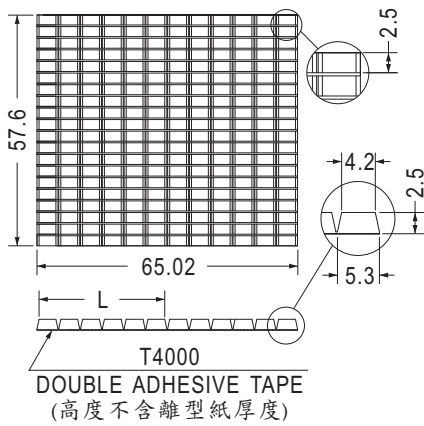

Part No.	L	Package
EM-18-1	4.2	240PCS
EM-18-2	9.65	
EM-18-3	15.1	
EM-18-4	20.5	
EM-18-5	25.95	
EM-18-6	31.4	

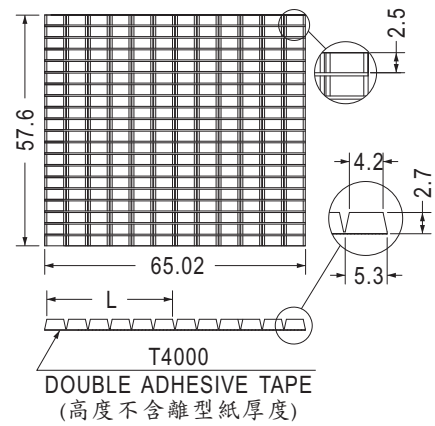

Part No.	L	Package
EMD-78-1	4.2	240PCS
EMD-78-2	9.65	
EMD-78-3	15.1	
EMD-78-4	20.5	
EMD-78-5	25.95	
EMD-78-6	31.4	

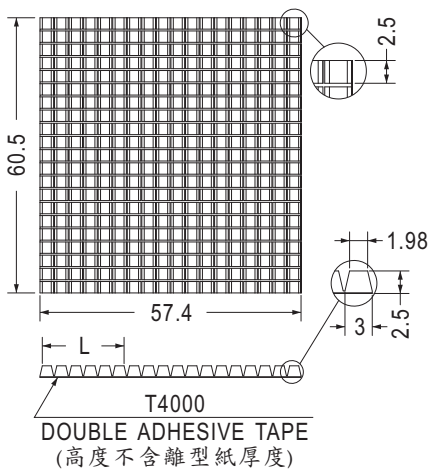

Part No.	L	Package
EM-40-1	1.98	378PCS
EM-40-2	5.18	
EM-40-3	8.38	
EM-40-4	11.58	
EM-40-5	14.78	
EM-40-6	17.98	

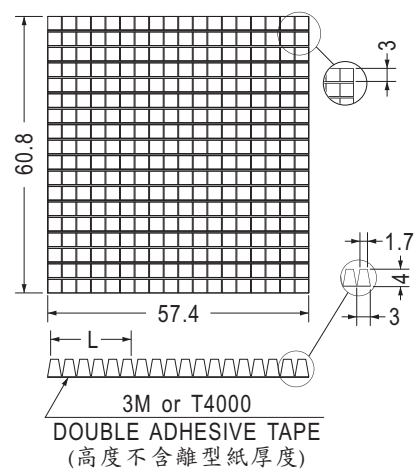

Part No.	L	Package
EM-535-1	1.7	324PCS
EM-535-2	4.9	
EM-535-3	8.1	
EM-535-4	11.3	
EM-535-5	14.5	
EM-535-6	17.7	

TO-220電晶體座 TRANSISTOR HOUSING

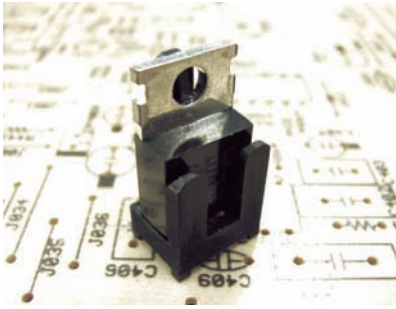

- Material: Nylon 66 (UL)
- Flame Class: 94V-2/94V-0
- Color: Natural/Black
- Unit: mm

用途：保護TO-220包裝之晶體立於PC板上，使接腳不彎曲、折斷、短路、且高度一致，增加可靠性。

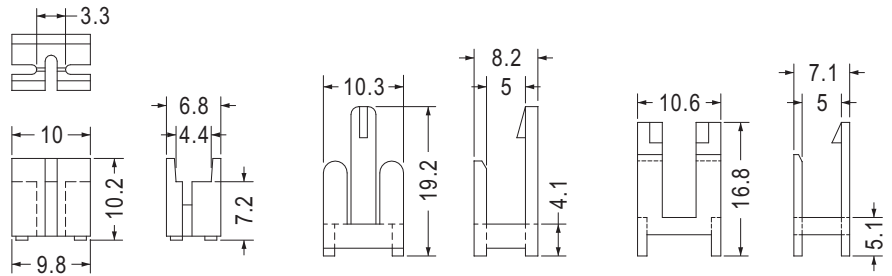

Part No.	Package
TR-1	1000

Part No.	Package
TR-2	1000

Part No.	Package
TR-5	1000

電晶體座 TRANSISTOR HOUSING

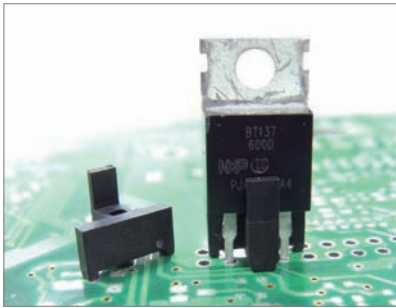

- Material: PBT (UL)
- Flame Class: 94V-0
- Color: Black
- Unit: mm

用途：保護晶體立於PC板上，使接腳不彎曲、折斷、短路，且高度一致。

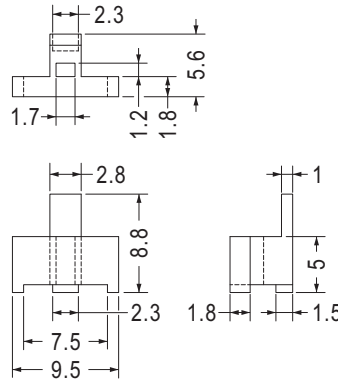

Part No.	Package
TR-30	1000

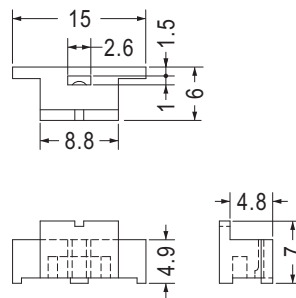
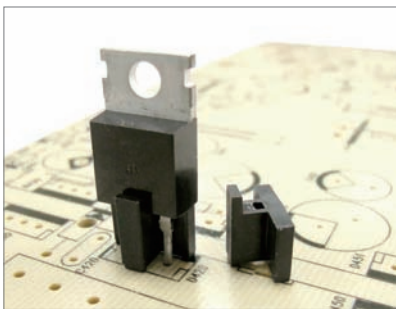

Part No.	Package
TR-7	1000

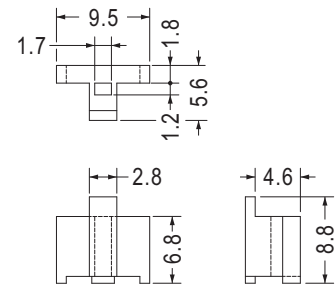

Part No.	Package
TR-8	1000

TO-3電晶體座 TRANSISTOR HOUSING

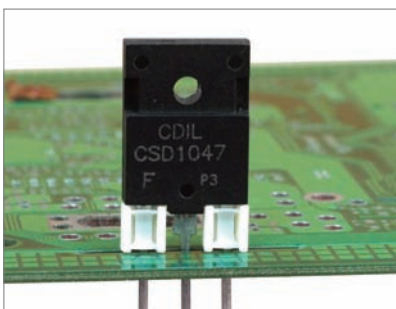

- Material: Nylon 66 (UL)
- Flame Class: 94V-2/94V-0
- Color: Natural/Black
- Unit: mm

用途：保護TO-3P功率晶體，保護晶體立於PC板上，使接腳不彎曲、折斷、短路，且高度一致。

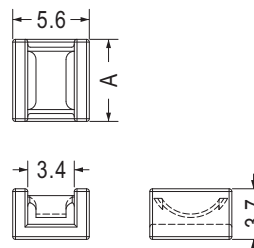

Part No.	A	Package
TR-34	4.2	1000
TR-36	6.0	
TR-38	4.6	

電晶體座 TRANSISTOR HOUSING

用途：保護晶體立於PC板上，使接腳不彎曲、折斷、短路，且高度一致。

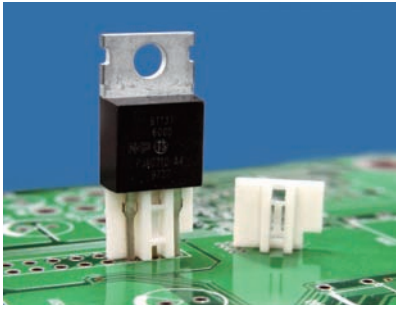

- Material: PBT (UL)
- Flame Class: 94V-0
- Color: Natural
- Unit: mm

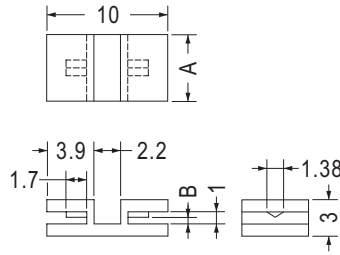

Part No.	A	B	Package
TR-10A	5.5	0.5~0.6	1000
TR-10S	5.5	0.4	
TR-17	7.5	0.5~0.6	

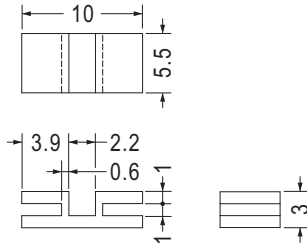

Part No.	Package
TR-10	1000

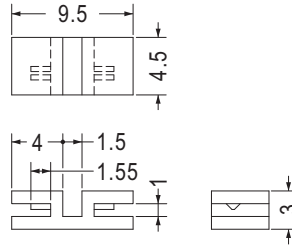

Part No.	Package
TR-11	1000

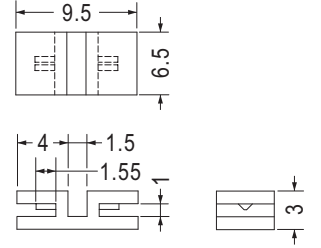

Part No.	Package
TR-13	1000

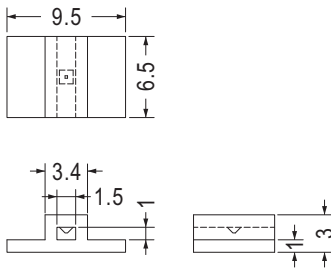

Part No.	Package
TR-14	1000

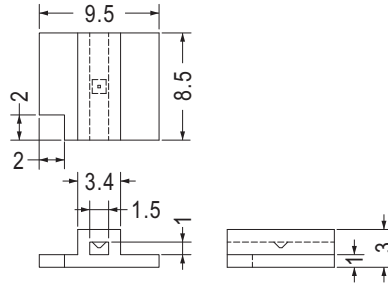

Part No.	Package
TR-16	1000

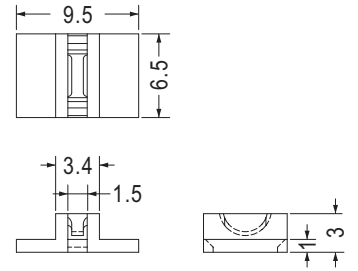

Part No.	Package
TR-21	1000

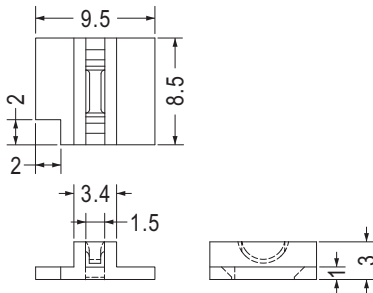

Part No.	Package
TR-22	1000

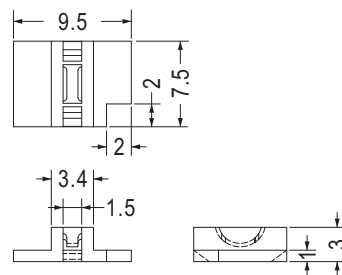

Part No.	Package
TR-29	1000

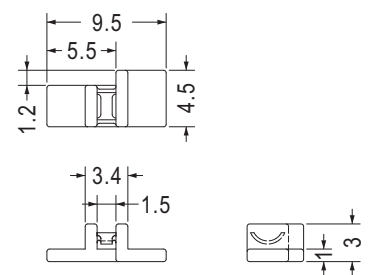

Part No.	Package
TR-35	1000

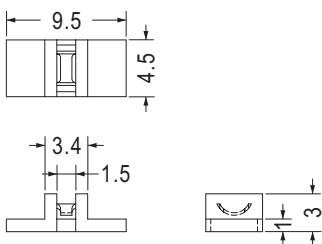

Part No.	Package
TR-23	1000

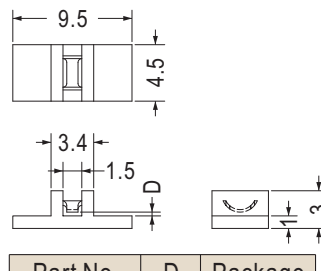

Part No.	D	Package
TR-23S	0.3	1000
TR-26	0.5	

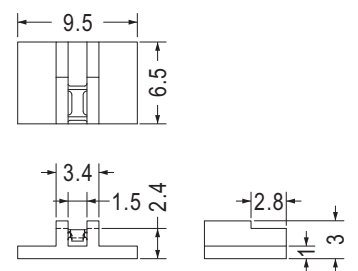

Part No.	Package
TR-45	1000

電晶體座 TRANSISTOR HOUSING

用途：保護晶體立於PC板上，使接腳不彎曲、折斷、短路，且高度一致。

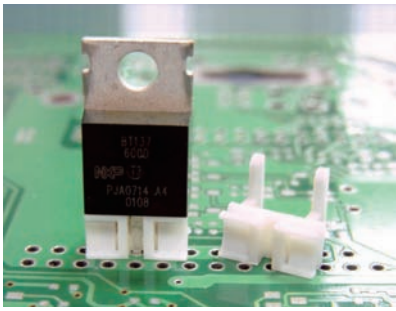

- Material: Nylon 66 (UL)
- Flame Class: 94V-2/94V-0
- Color: Natural/Black
- Unit: mm

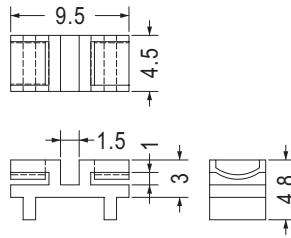

Part No.	Package
TR-24	1000

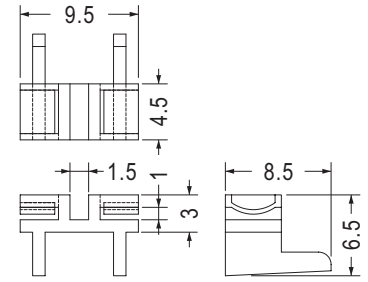

Part No.	Package
TR-25	1000

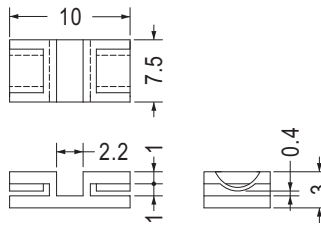
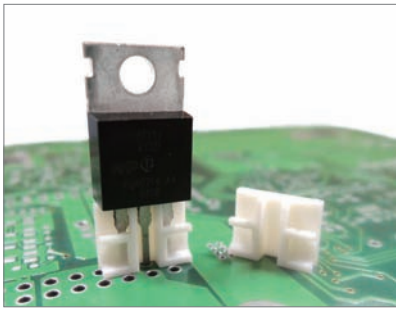

Part No.	Package
TR-18	1000

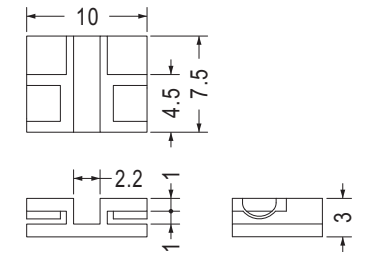

Part No.	Package
TR-37	1000



- Material: Nylon 66 (UL)/PBT (UL)
- Flame Class: 94V-2/94V-0
- Color: Natural/Black
- Unit: mm

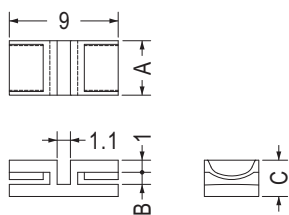

【 TRG-4.5L 】

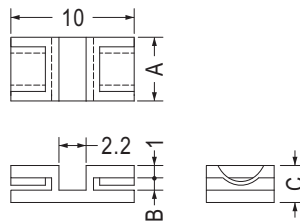

Part No.	A	B	C	Package
TRG-3.5	3.5	1.0	3.0	1000
TRG-4	4.0	1.0	3.0	
TRG-4.5	4.5	1.0	3.0	
TRG-4.5L	4.5	1.0	3.0	
TRG-5	5.0	1.0	3.0	
TRG-5.5	5.5	1.0	3.0	
TRG-6	6.0	1.0	3.0	
TRG-6.5	6.5	1.0	3.0	
TRG-6.5L	6.5	1.3	3.3	
TRG-7	7.0	1.0	3.0	
TRG-7.5	7.5	1.0	3.0	
TRG-8	8.0	1.0	3.0	
TRG-8.5	8.5	1.0	3.0	
TRG-9	9.0	1.0	3.0	
TRG-9.5	9.5	1.0	3.0	
TRG-10	10.0	1.0	3.0	

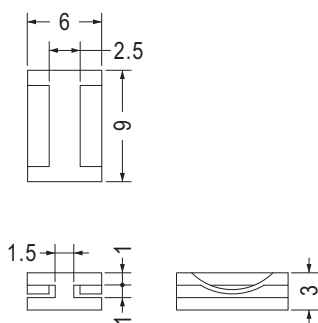

Part No.	Package
TRGS-9	1000

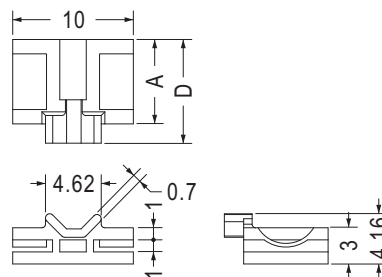

Part No.	A	D	Package
TRGV-5	5.0	6.6	1000
TRGV-6.7	6.7	8.3	
TRGV-7	7.0	8.6	

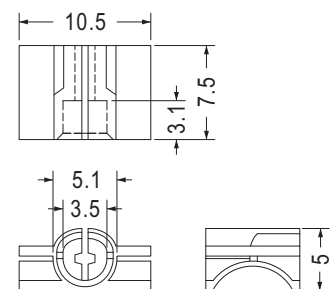

Part No.	Package
TRO-7.5	1000

電晶體座 TRANSISTOR HOUSING

用途：保護晶體立於PC板上，使接腳不彎曲、折斷、短路，且高度一致。

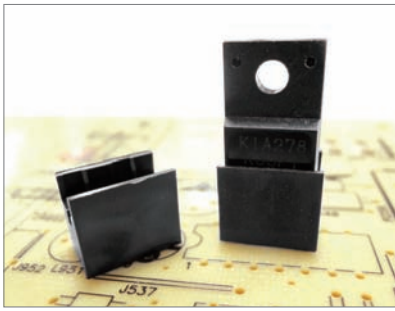

- Material: Nylon 66 (UL)
- Flame Class: 94V-2/94V-0
- Color: Natural/Black
- Unit: mm

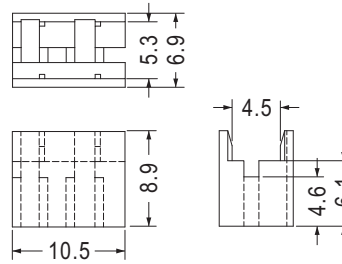

Part No.	Package
TRD-1	1000

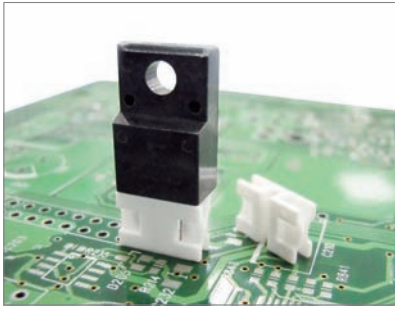

- Material: Nylon 66 (UL)/PBT (UL)
- Flame Class: 94V-2/94V-0
- Color: Natural/Black
- Unit: mm

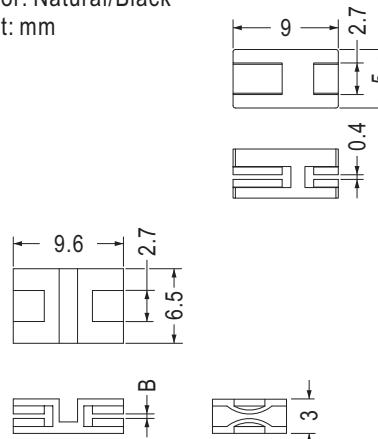

Part No.	B	Package
TRU-6.5	0.4	1000
TRU-6.5PV05	0.5	

Part No.	Package
TRS-5	500

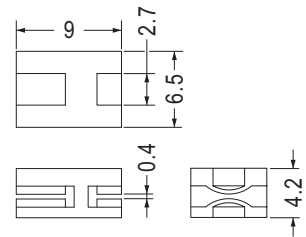

Part No.	Package
TRS-6.5	500

6

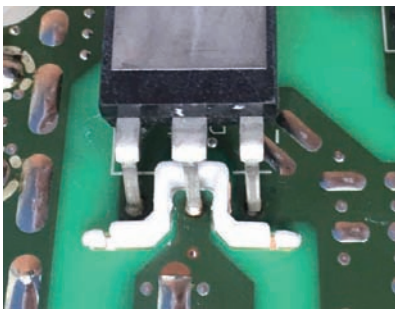

- Material: Nylon 66 (UL)
- Flame Class: 94V-2/94V-0
- Color: Natural/Black
- Unit: mm

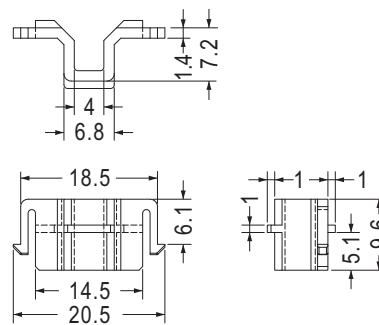

Part No.	Package
TRGL-1	1000

用途：保護電晶體接腳間之絕緣，不使接腳短路。

TO-220電晶體座 TRANSISTOR HOUSING

用途：用於TO-220功率晶體組裝。

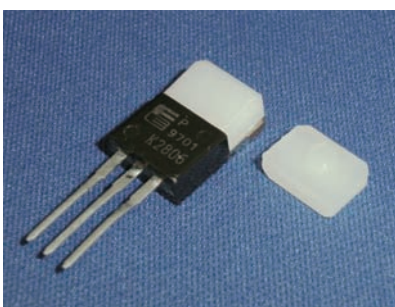

- Material: Nylon 66 (UL)
- Flame Class: 94V-2/94V-0
- Color: Natural/Black
- Unit: mm

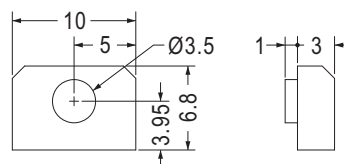

Part No.	Package
TRF-1	2000

TO-3電晶體座 TRANSISTOR HOUSING



- Material: Nylon 66 (UL)
- Flame Class: 94V-2/94V-0
- Color: Natural/Black
- Unit: mm

用途：保護TO-3功率晶體，保護晶體立於PC板上，使接腳不彎曲、折斷、短路，且高度一致。

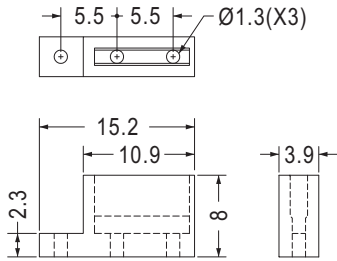

Part No.	Package
TRWA-1	1000

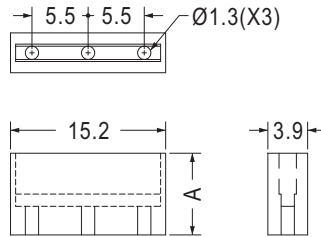

Part No.	A	Package
TRW-8	8.0	1000
TRW-10	10.0	

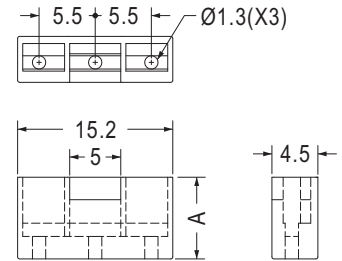

Part No.	A	Package
TRWF-8	8.0	1000
TRWF-10	10.0	

電晶體座 TRANSISTOR HOUSING

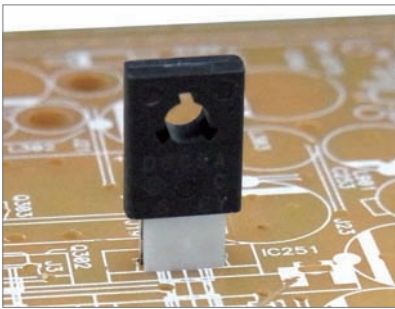

- Material: Nylon 66 (UL)
- Flame Class: 94V-2/94V-0
- Color: Natural/Black
- Unit: mm

用途：保護晶體立於PC板上，使接腳不彎曲、折斷、短路，且高度一致。

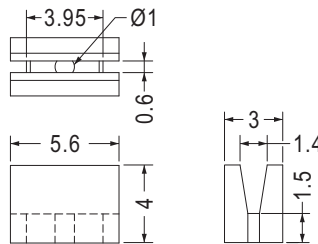

Part No.	Package
TR-9	1000

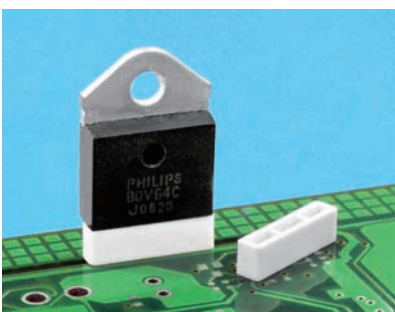

- Material: PBT (UL)
- Flame Class: 94V-0
- Color: Natural
- Unit: mm

用途：適用於TO-247功率晶體，保護晶體立於PC板上，使接腳不彎曲、折斷、短路，且高度一致。

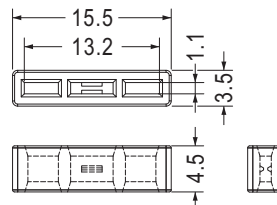

Part No.	Package
TRW3-2	1000

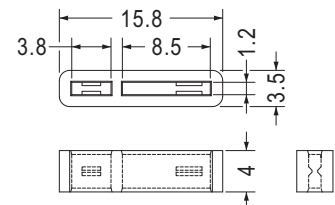

Part No.	Package
TRW3-6	1000

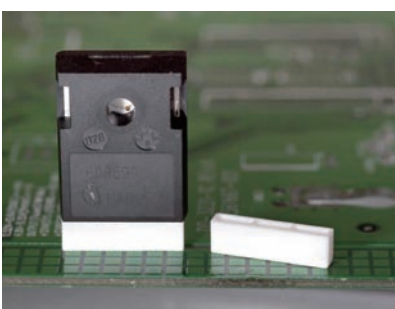

- Material: Nylon 66 (UL)
- Flame Class: 94V-2/94V-0
- Color: Natural/Black
- Unit: mm

用途：適用於功率晶體，保護晶體立於PC板上，使接腳不彎曲、折斷、短路，且高度一致。

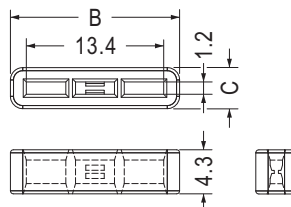

Part No.	B	C	Package
TRW3-3	16.5	4.0	1000
★ TRW3-7	15.0	2.8	

電晶體座 TRANSISTOR HOUSING

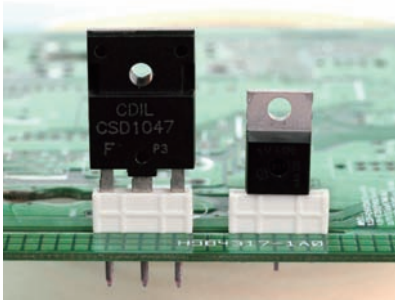

- Material: PBT (UL)
- Flame Class: 94V-0
- Color: Natural/White
- Unit: mm

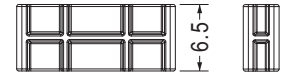
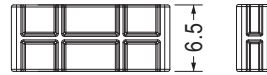
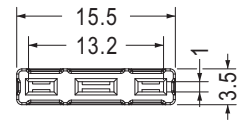
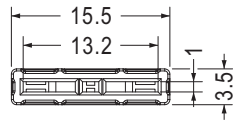

Part No.	Package
TRW3-4	1000

Part No.	Package
TRW3-5	1000

用途：保護晶體立於PC板上，使接腳不彎曲、折斷、短路，且高度一致。

TO-220電晶體座 TRANSISTOR HOUSING



- Material: Nylon 66 (UL)
- Flame Class: 94V-2/94V-0
- Color: Natural/Black
- Unit: mm

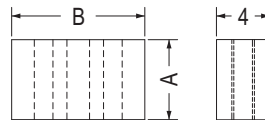
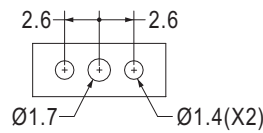

用途：保護TO-220晶體立於PC板上，使接腳不彎曲、折斷、短路，且高度一致，增加可靠度。

Part No.	A	B	Package
TR3-3S	3.0	9.8	1000
TR3-3	3.7	9.8	
TR3-4	4.0	9.8	
TR3-5	5.0	10.0	
TR-3	6.0	9.8	
TR3-7	7.0	9.8	
TR3-8.5	8.5	9.8	
TR3-9	9.0	9.8	
TR3-9.5	9.5	9.8	

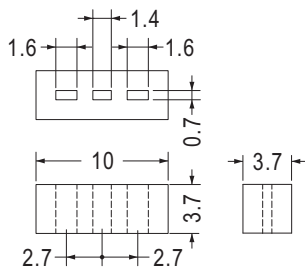

Part No.	Package
TR-19	2000

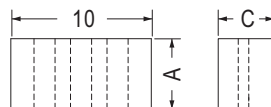
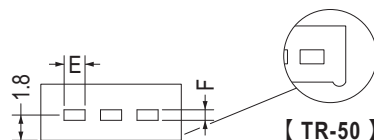

Part No.	A	C	E	F	Package
TR-12	5.0	4.0	1.5	0.75	1000
TR-31	3.0	3.0	1.5	0.75	
TR-50	5.0	4.3	1.7	1.0	

電晶體座 TRANSISTOR HOUSING



- Material: Nylon 66 (UL)
- Flame Class: 94V-2/94V-0
- Color: Natural/Black
- Unit: mm

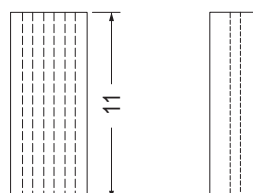
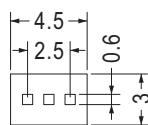

用途：保護晶體立於PC板上，使接腳不彎曲、折斷、短路，且高度一致。

Part No.	Package
TR3-11-1	1000

電晶體座 TRANSISTOR HOUSING

用途：保護晶體立於PC板上，使接腳不彎曲、折斷、短路，且高度一致。

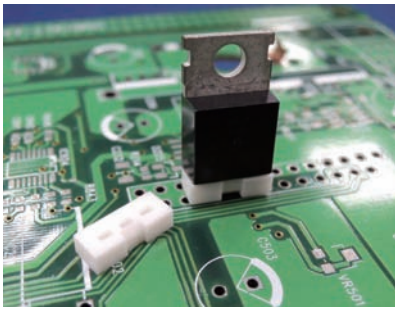

- Material: Nylon 66 (UL)
- Flame Class: 94V-2/94V-0
- Color: Natural/Black
- Unit: mm

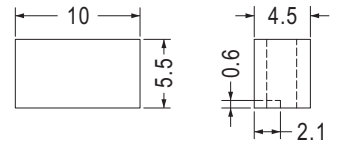
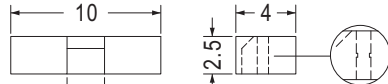
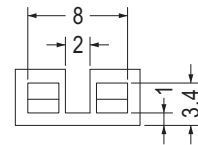
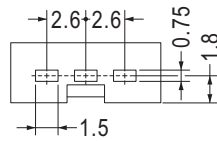

【TR-41】

Part No.	Package
TR-32	1000
TR-41	1000

Part No.	Package
TR-43	1000

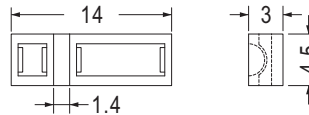
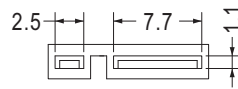
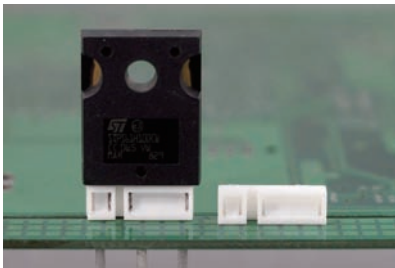

Part No.	Package
TRGC-4.5	1000



- Material: Nylon 66 (UL)
- Flame Class: 94V-2/94V-0
- Color: Natural/Black
- Unit: mm

用途：用於電晶體或零件之墊高與保護。

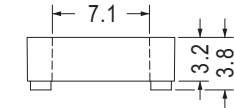
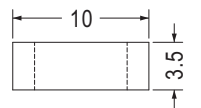
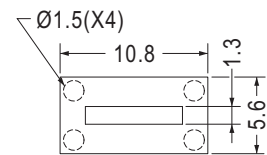
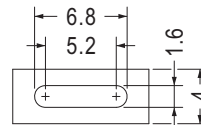

Part No.	Package
TR-33	1000

Part No.	Package
TR-42	1000

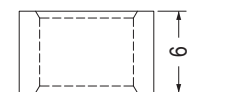
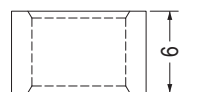
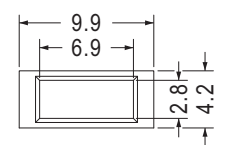
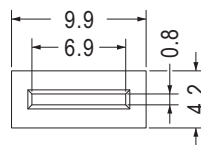
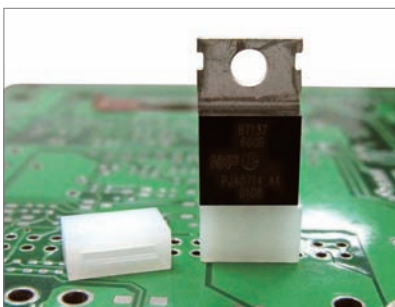

Part No.	Package
SUMA-6	1000

Part No.	Package
SUM-6	1000

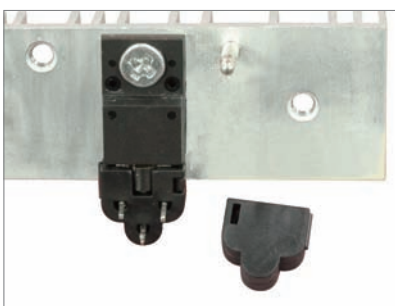

- Material: Nylon 66 (UL)
- Flame Class: 94V-2/94V-0
- Color: Natural/Black
- Unit: mm
- Patented (專利品)

用途：用於功率晶體之絕緣與防塵。

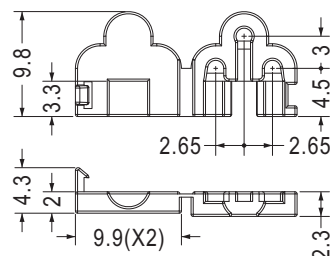

Part No.	Package
TRGB-1	1000

橋式整流座 BRIDGE RECTIFIER HOUSING

用途：保護橋式整流器立於PC板上使接腳不彎曲、折斷、短路且高度一致。

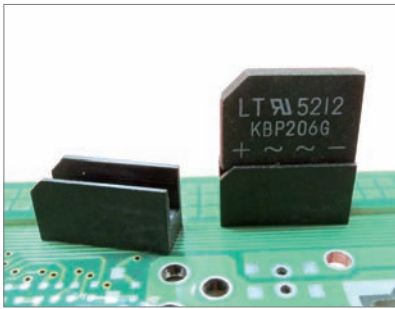

- Material: PBT (UL)
- Flame Class: 94V-0
- Color: Natural/ Black
- Unit: mm

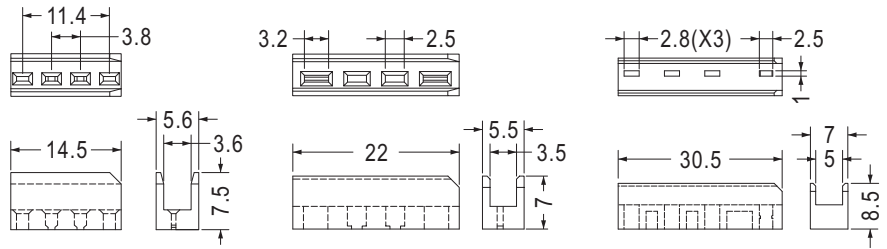

Part No.	Package
BGCV-15	500

Part No.	Package
BGCV-22	500

Part No.	Package
BGCV-30	500



- Material: Nylon 66 (UL)
- Flame Class: 94V-2/94V-0
- Color: Natural/Black
- Unit: mm

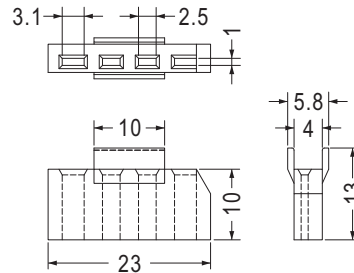

Part No.	Package
BGCV-23	500

6

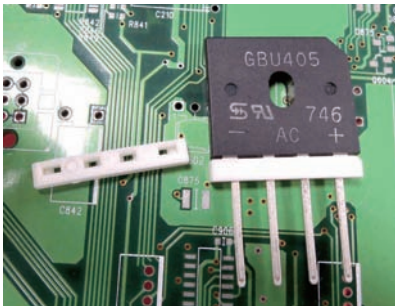

- Material: PBT (UL)
- Flame Class: 94V-0
- Color: Natural
- Unit: mm

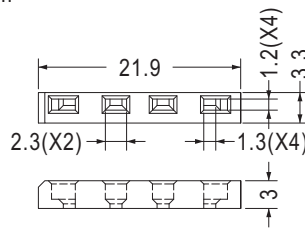

Part No.	Package
BGCA-22	1000

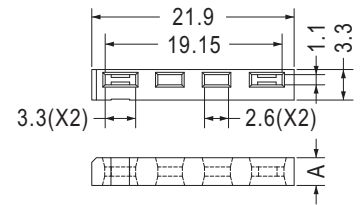

Part No.	A	Package
BGCC-22	3.0	1000
★BGCC-22-5	5.0	

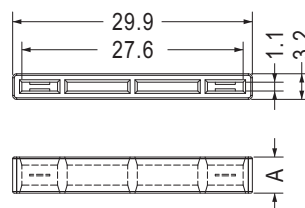

- Color: White

Part No.	A	Package
BGCB-30	4.5	1000
BGCB-30-8.5	8.5	

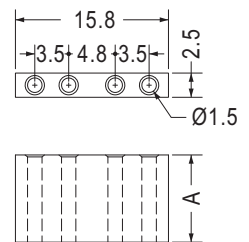

- Color: Black

Part No.	A	Package
BWC-1	9.0	1000
BWC-2	18.0	

霍爾晶體座 HALL SENSOR HOUSING

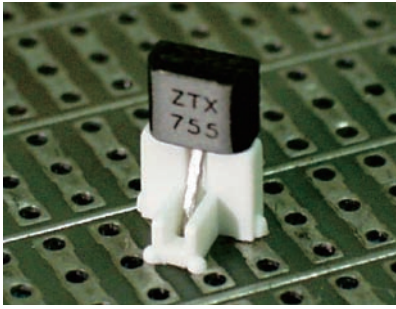

- Material: Nylon 66 (UL)
- Flame Class: 94V-2/94V-0
- Color: Natural/Black
- Unit: mm

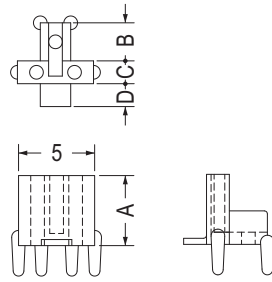

用途：保護霍爾晶體立於PC板上，使接腳不彎曲、折斷、短路且高度一致。

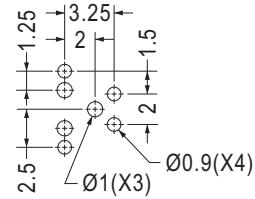

MOUNTING HOLE

Part No.	A	B	C	D	Package
HLS-1	4.6	2.5	1.5	1.5	2000
HLS-2	10.5	2.4	1.7	1.4	

可變電阻蓋 VARIABLE RESISTOR COVER



- Material: Nylon 66 (UL)
- Flame Class: 94V-2/94V-0
- Color: Natural/Black
- Unit: mm

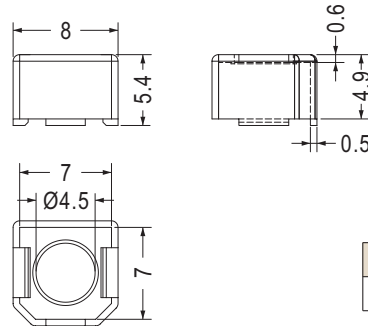

用途：可變電阻調整好，避免誤觸。

Part No.	Package
VRCV-1	2000

熱敏電阻座 THERMISTOR HOLDER



- Material: Nylon 66 (UL)
- Flame Class: 94V-2/94V-0
- Color: Natural/Black
- Unit: mm

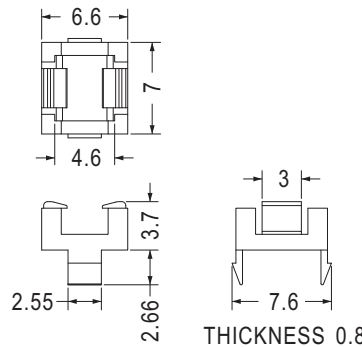

用途：用於熱敏電阻接腳之固定與保護。

Part No.	Package
TRE-1-1	2000

IR晶體座 IR RECEIVER HOLDER



- Material: Nylon 66 (UL)
- Flame Class: 94V-2/94V-0
- Color: Natural/Black
- Unit: mm

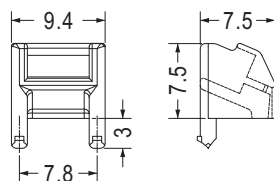

用途：保護IR晶體立於PC板上，使接腳不彎曲、折斷、短路，且高度一致。

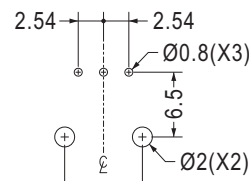

MOUNTING HOLE THICKNESS 1.6

Part No.	Package
RECD-3	1000

IR 晶體座 IR RECEIVER HOLDER

用途：保護IR晶體立於PC板上，使接腳不彎曲、折斷、短路，且高度一致。

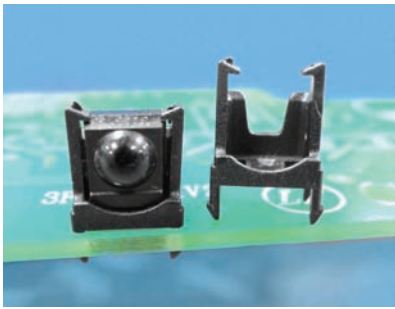

- Material: Nylon 66 (UL)
- Flame Class: 94V-2/94V-0
- Color: Natural/Black
- Unit: mm
- Patented (專利品)

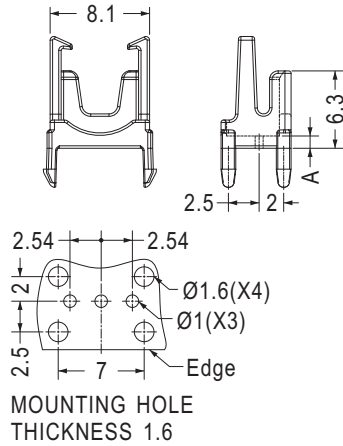

Part No.	A	Package
RECA-1	1.0	1000
RECA-1.5	1.5	
RECA-2	2.0	
RECA-2.5	2.5	
RECA-3	3.0	
RECA-3.5	3.5	
RECA-4	4.0	
RECA-4.5	4.5	
RECA-5	5.0	
RECA-5.5	5.5	
RECA-6	6.0	

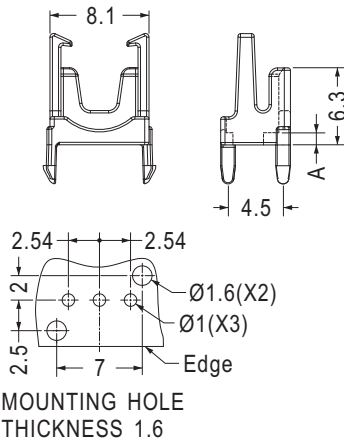

Part No.	A	Package
RECG-1	1.0	1000
RECG-1.5	1.5	
RECG-2	2.0	
RECG-2.5	2.5	
RECG-3	3.0	
RECG-3.5	3.5	
RECG-4	4.0	
RECG-4.5	4.5	
RECG-5	5.0	
RECG-5.5	5.5	
RECG-6	6.0	

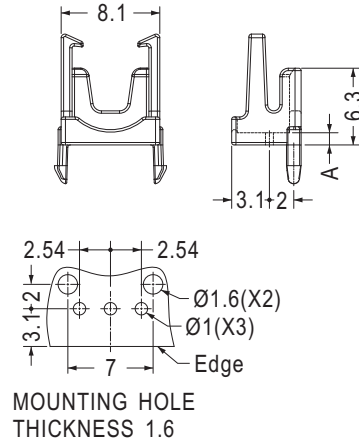

Part No.	A	Package
RECC-1	1.0	1000
RECC-1.5	1.5	
RECC-2	2.0	
RECC-2.5	2.5	
RECC-3	3.0	
RECC-3.5	3.5	
RECC-4	4.0	
RECC-4.5	4.5	
RECC-5	5.0	
RECC-5.5	5.5	
RECC-6	6.0	

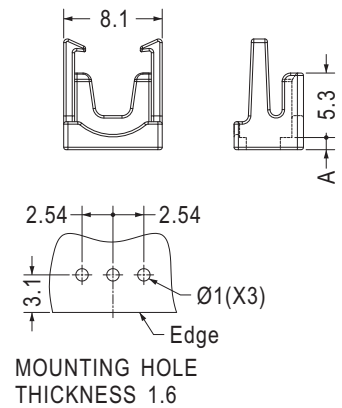

Part No.	A	Package
RECE-1	1.0	1000
RECE-1.5	1.5	
RECE-2	2.0	
RECE-2.5	2.5	
RECE-3	3.0	
RECE-3.5	3.5	
RECE-4	4.0	
RECE-4.5	4.5	
RECE-5	5.0	
RECE-5.5	5.5	
RECE-6	6.0	
RECE-7	7.0	

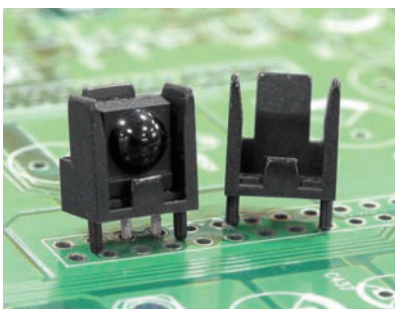

- Material: Nylon 66 (UL)
- Flame Class: 94V-2/94V-0
- Color: Natural/Black
- Unit: mm

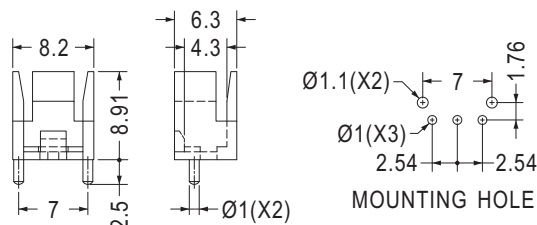

Part No.	Package
RECI-1	1000

電晶體座 IR TRANSISTOR HOUSING

用途：保護IR晶體立於PC板上，使接腳不彎曲、折斷、短路，且高度一致。



- Material: Nylon 66 (UL)
- Flame Class: 94V-2/94V-0
- Color: Natural/Black
- Unit: mm

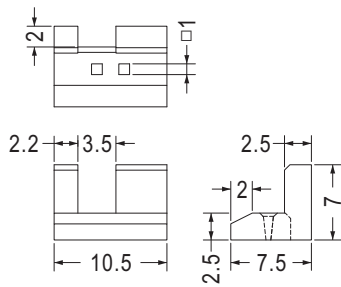

Part No.	Package
TR-46	1000

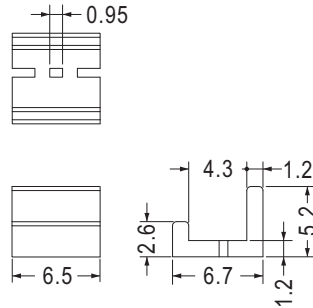

Part No.	Package
TRA-1	1000

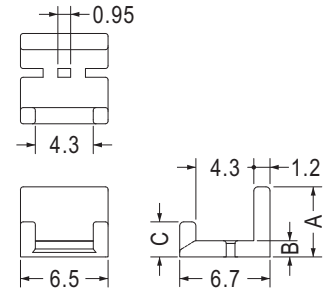

Part No.	A	B	C	Package
TRAC-1.2	5.2	1.2	2.6	1000
TRAC-2	6.0	2.0	3.4	
TRAC-5.3	9.3	5.3	6.7	

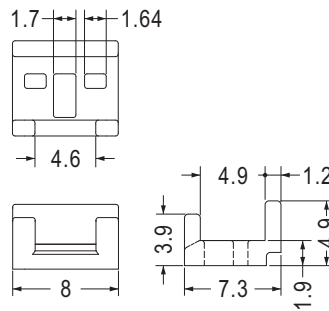

Part No.	Package
TRAD-0.9	1000

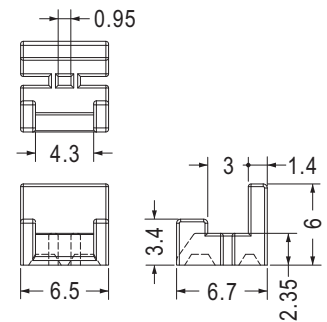

Part No.	Package
TRAE-2.35	1000

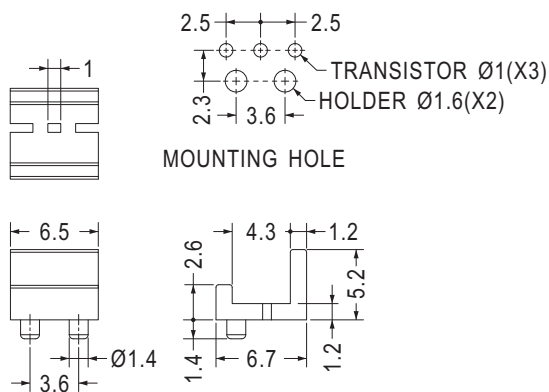

Part No.	Package
TRAB-1	1000

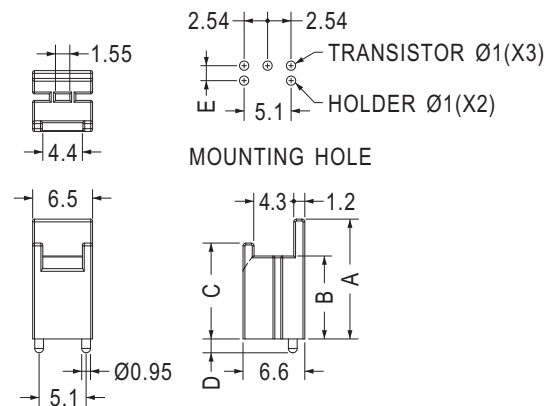

Part No.	A	B	C	D	E	Package
TRAC-9	13.0	9.0	10.4	1.5	1.6	1000
TRAC-10.8L	14.8	10.8	12.2	0.9	2.4	

光電晶體座 IR RECEIVER HOLDER

用途：用於光晶體腳座，固定高度可過錫爐，美觀整齊。

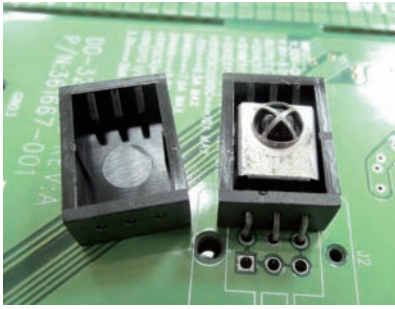

- Material: Nylon 66 (UL)
- Flame Class: 94V-2/94V-0
- Color: Natural/Black
- Unit: mm

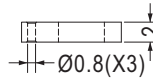
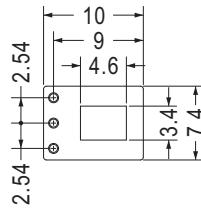

Part No.	Package
RCEA-2	1000

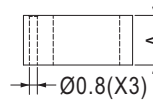
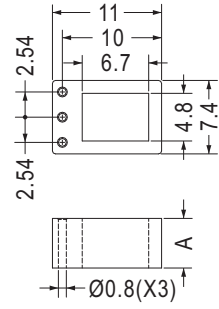

Part No.	A	Package
RCEA-3	3.0	1000
RCEA-5	5.0	
RCEA-6	6.0	
RCEA-12.6	12.6	

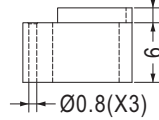
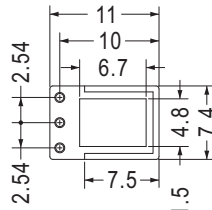
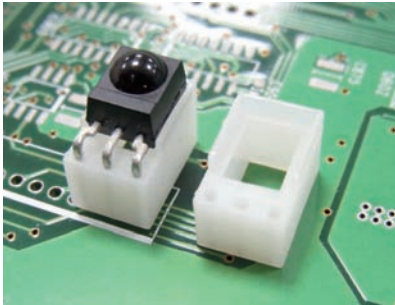

Part No.	Package
RCEA-10	1000

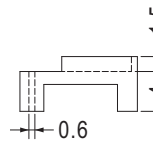
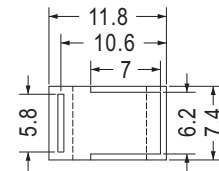

Part No.	Package
RCEA-4	1000

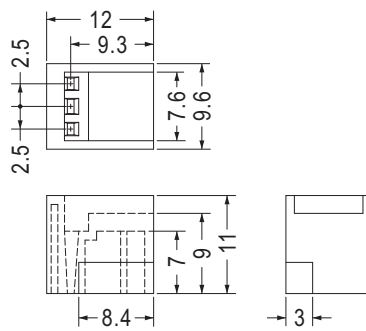

Part No.	Package
RCEA-9	1000

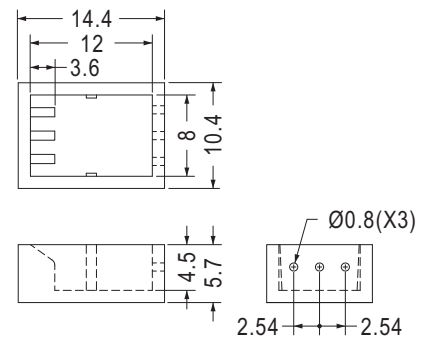

Part No.	Package
RCEC-2	1000

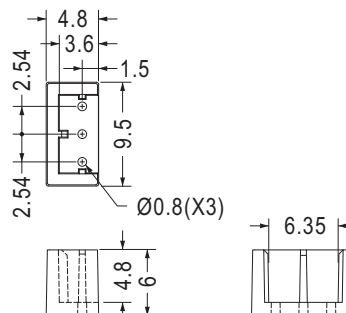

Part No.	Package
RCEF-1	1000

光電晶體座 IR RECEIVER HOLDER

用途：用於光晶體腳座，固定高度可過錫爐，美觀整齊。

- Material: Nylon 66 (UL)
- Flame Class: 94V-2/94V-0
- Color: Natural/Black
- Unit: mm

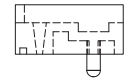
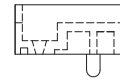
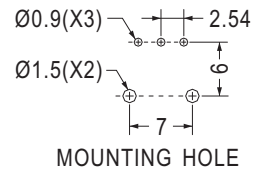
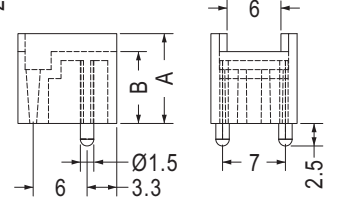
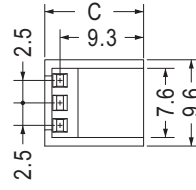
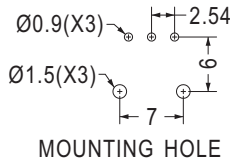
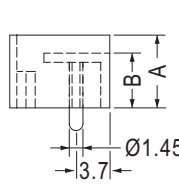
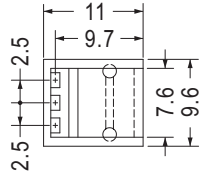
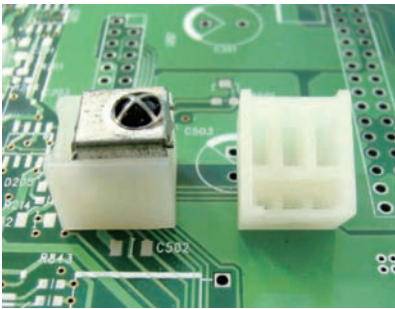
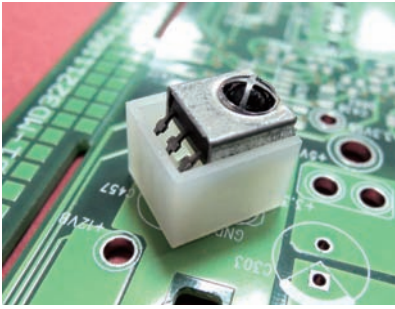

【 RCEB-3.5 】

【 RCEB-3.5D 】

Part No.	A	B	Package
RCEB-4.5	6.5	4.5	1000
RCEB-6	8.0	6.0	

Part No.	A	B	C	Package
RCEB-3.5	5.5	3.5	12.0	1000
RCEB-3.5D	5.5	3.5	12.0	
RCEB-8	10.0	8.0	11.0	
RCEB-9	11.0	9.0	11.0	
RCEB-10.5	12.5	10.5	11.0	

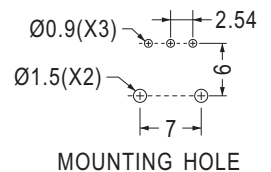
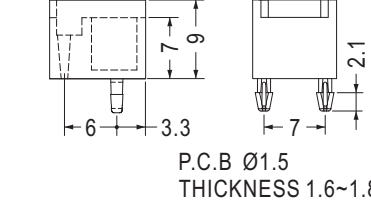
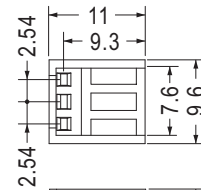
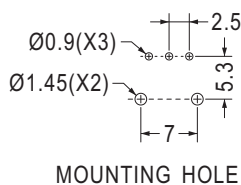
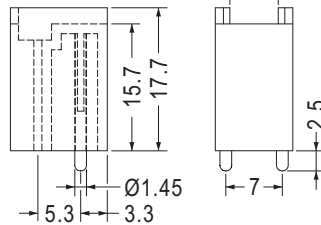
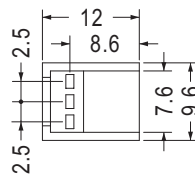
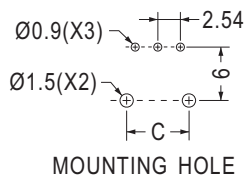
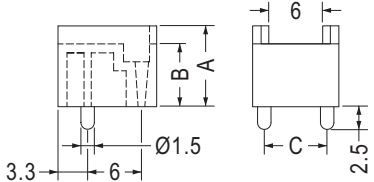
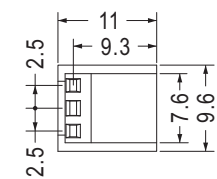

Part No.	A	B	C	Package
RCEB-7	9.0	7.0	7.0	1000
RCEB-15	17.0	15.0	6.0	

Part No.	Package
RCEB-15.7	1000

Part No.	Package
RCEE-7	1000

光電晶體座 IR RECEIVER HOLDER

用途：用於光晶體腳座，固定高度可過錫爐，美觀整齊。

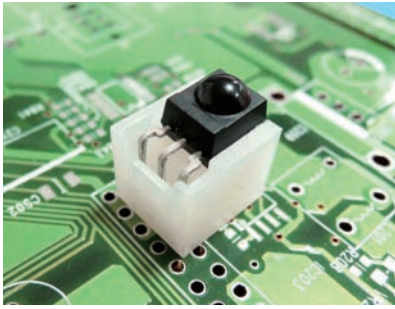

- Material: Nylon 66 (UL)
- Flame Class: 94V-2/94V-0
- Color: Natural/Black
- Unit: mm

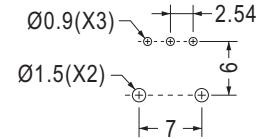
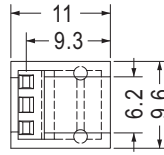

MOUNTING HOLE

Part No.	Package
RCEH-1	1000

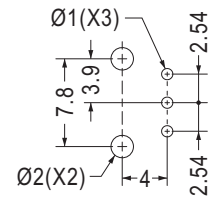
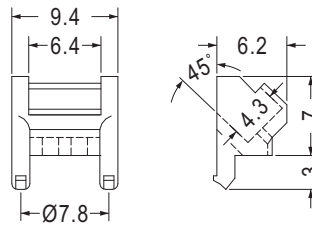
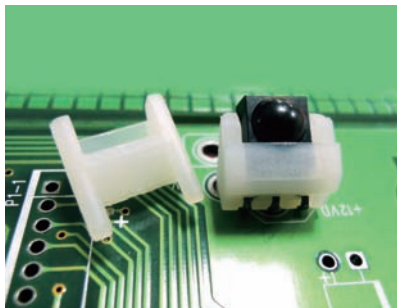
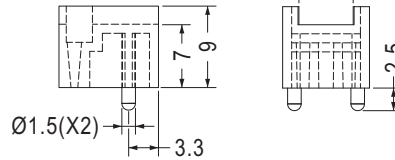

MOUNTING HOLE

Part No.	Package
RECD-1	1000

光纖晶體座 OPTICAL LENS HOLDER

用途：光纖晶體焊於PC板上，高度一致，有定位腳，不傾斜，可與 OPC-1 配合使用。



- Material: Nylon 66 (UL)
- Flame Class: 94HB
- Color: Black
- Unit: mm

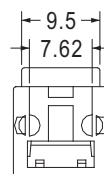
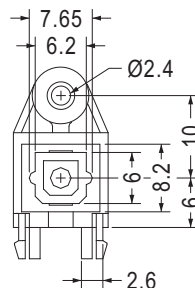

Part No.	Package
PLT130T	1000

尼龍華司 WASHER

用途：做為零件之墊片。



- Material: Nylon 66/Nylon 6 (UL)/PE/PBT (UL)/PP(UL)/POM (UL)
- Color: Natural/Black
- Unit: mm

可依客戶需求訂製不同材質。
Different materials available per request.

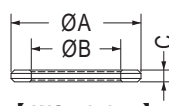
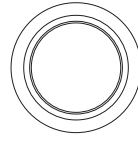
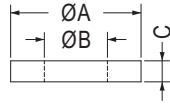
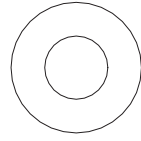

【 WS5.3-0.7 】

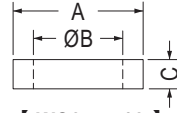
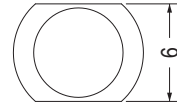

【 WS8-55-18 】

Part No.	A	B	C
WS4.5-1.5N	10.0	4.5	1.5
WS10-5124	10.0	5.1	2.4
WS10-5.2-0.8	10.0	5.2	0.8
WS5-1	10.0	5.2	1.0
WS5-2	10.0	5.2	2.0
WS5.5-0.8	10.0	5.5	0.8
WS10-5710	10.0	5.7	1.0
WS10-5720	10.0	5.7	2.0
WS6.1-1.6	10.0	6.1	1.6
WS-1064	10.0	6.4	0.8
WS106428	10.0	6.4	2.8
WS8-1.6	10.0	8.0	1.6
WS6.35-1.6	10.15	6.35	1.6
WS1015	10.2	5.2	1.5
WS11-4.4-0.8	10.9	4.4	0.8
WS5.2111.5	11.0	5.2	1.5
WS11785	11.0	7.0	0.8
WS7.2-1.2	11.0	7.2	1.2
WS7.2-2.5	11.0	7.2	2.5
WS11-5-1.3	11.3	5.4	1.3
WS7.6-0.5	11.3	7.6	0.5
WS115-35-4	11.5	3.5	4.0
WS3.2-1	11.6	3.2	1.0
WS7.6-1	11.6	7.6	1.0
WS4.3-1	12.0	4.3	1.0
WS12-5-2	12.0	5.0	2.0
WS5.2-0.8	12.0	5.2	0.8
WS5.3-2	12.0	5.3	2.0
WS12-64-1.4	12.0	6.4	1.4
WS1276415	12.7	6.48	1.52
WS1276420	12.7	6.48	2.0
WS1276565	12.7	6.5	6.5
WS12779215	12.7	7.9	1.57
WS6-0.8	12.8	6.4	0.8
WS6-2	12.8	6.4	2.0
WS6.48-3	12.8	6.48	3.0
WS8.1-1.6	13.0	8.1	1.6
WS12.5-1	13.4	12.5	1.0
WS-148	14.0	8.0	1.2
WS-1482	14.0	8.0	2.0
WS8.1-0.8	14.0	8.1	0.8

Part No.	A	B	C
WS14263515	14.2	6.35	1.5
WS14-11-1	14.7	11.5	1.0
WS4.3-1.5	15.0	4.3	1.5
WS7-1	15.0	7.1	1.0
WS10-5	15.0	10.3	5.0
WS6.7-0.65	15.5	6.7	0.65
WS7.1-1.5	15.8	7.1	1.5
WS15.8-9.1-1.7	15.8	9.1	1.65
WS6-1.6	16.0	6.0	1.6
WS8.4-1.6	16.0	8.4	1.6
WS16-96-15	16.0	9.6	1.5
WS10-0.8	16.0	10.0	0.8
WS10-1.5	16.0	10.0	1.5
WS16-11-32	16.0	11.4	3.2
WS10.3-1	16.2	10.3	1.0
WS10.3-1.5	16.2	10.3	1.5
WS10.1-2	17.0	10.1	2.0
WS18-6.4-1.6	18.0	6.4	1.6
WS8-1	18.0	8.2	1.0
WS8.4-1	18.0	8.4	1.0
WS8.4-1.5	18.0	8.4	1.5
WS19-11-1.6	19.0	11.0	1.6
WS12.1-2.5	19.0	12.1	2.5
WS19-14-3.2	19.05	14.35	3.18
WS5-1.2	19.5	5.0	1.2
WS20-6.5-2	20.0	6.5	2.0
WS17-1.3	20.2	17.8	1.3
WS14-3.6	20.3	14.5	3.65
WS14-4	20.3	14.5	4.0
WS10-3	20.7	10.0	3.0
WS21-10-2	21.0	10.5	2.0
WS19.1-0.5	21.8	19.1	0.5
WS221350	22.0	13.0	5.0
WS13-2	23.0	13.0	2.0
WS8-3	24.0	8.05	3.0
WS16.1-2.5	24.0	16.1	2.5
WS16.1-3	24.0	16.1	3.0
WS25-10	25.0	14.5	10.0
WS29-17-3	29.5	17.2	3.0
WS30-6-1.5	30.0	6.0	1.5
★WS6.3-2	30.0	6.3	2.0

Part No.	A	B	C
WS20.1-3.5	30.0	20.1	3.5
WS33-28-15	33.5	28.5	1.5
WS22.1-4	34.75	22.1	4.0
WS34-26-1	34.8	26.2	1.0
WS24.1-4	36.0	24.1	4.0
WS2905U	38.0	29.0	0.5
WS27.1-4.5	39.0	27.1	4.5
WS421905	42.0	19.0	0.5
WS40-1.5	45.5	40.0	1.5

螺絲墊片 SCREW WASHER

用途：可配合螺絲使用之墊片。

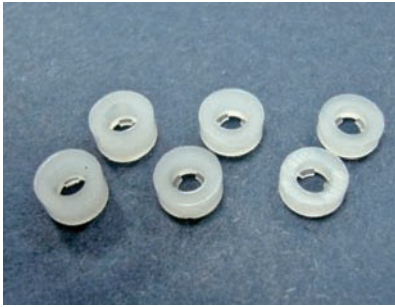

- Material: Nylon 66 (UL)
- Flame Class: 94V-2/94V-0
- Color: Natural/Black
- Unit: mm

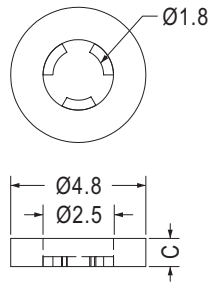

RECOMMENDED
MATING SCREW: M2

Part No.	C	Package
KWS2-05	0.5	2000
KWS2-08	0.8	
KWS2-10	1.0	
KWS2-15	1.5	
KWS2-20	2.0	
KWS2-25	2.5	

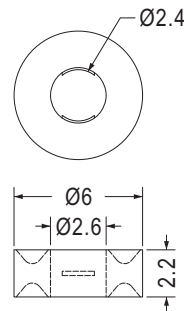
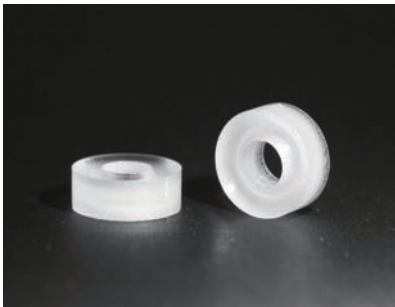

Part No.	Package
KWSB2.5-2.2	2000



- Material: Nylon 66 (UL)/PE/LDPE
- Flame Class: 94V-2/94V-0
- Color: Natural/Black/Blue
- Unit: mm

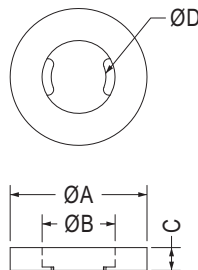

RECOMMENDED
MATING SCREW: S

Part No.	A	B	C	D	S	Package
KWSP2-1	5.0	2.7	1.0	2.2	M2.6	2000
KWSP2-1.1	6.5	2.7	1.1	2.2		
KWSP2-1.5	5.0	2.7	1.5	2.2		
KWSP-2.5	5.0	2.7	1.0	2.0	M3	1000
KWSP-2.6	6.0	3.2	1.0	2.4		
KWSP-9	18.0	10.5	1.5	8.7	M9	



- Material: Nylon 66 (UL)/Nylon 6 (UL)/PE
- Natural: 94HB/94V-2/94V-0
- Color: Natural/Black/Gray
- Unit: mm

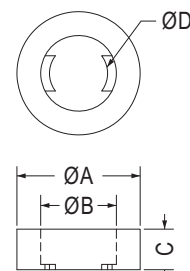

RECOMMENDED
MATING SCREW: S

Part No.	A	B	C	D	S	Package
KWSP3-1.5	9.0	3.2	1.5	2.6	M3	1000
KWSP4-1.4	12.0	4.3	1.4	3.3	M4	2000
KWSP4-2.3	7.0	4.3	2.3	3.3		
KWSP5-1	10.0	5.3	1.0	4.1	M5	
KWSP5-15	15.0	5.3	1.5	4.3		
KWSP6-1.6	12.0	6.4	1.6	5.0	M6	
KWSP6-2	18.0	6.4	2.0	5.15		
KWSP10-2.5	21.0	10.5	2.5	8.9	M10	1000

螺絲墊片 SCREW WASHER

用途：可配合螺絲使用之墊片。



- Material: PP (UL)
- Flame Class: 94HB
- Color: Black
- Unit: mm

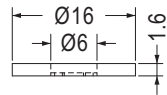
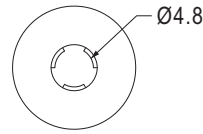

RECOMMENDED
MATING SCREW: M6

Part No.	Package
KWS5-1.6	2000

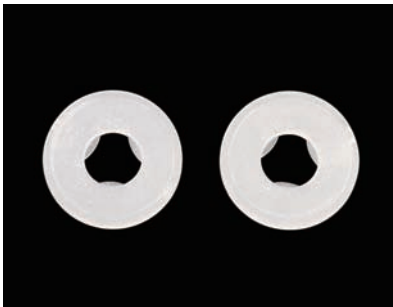

- Material: PE
- Color: Natural
- Unit: mm

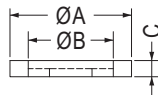
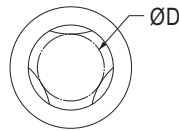

RECOMMENDED
MATING SCREW: S

Part No.	A	B	C	D	S	Package
KWS3-0.8	8.0	3.2	0.8	2.5	M3	2000
KWS5-1	20.0	5.3	1.0	4.2	M5	
KWS6-1.6	12.0	6.4	1.6	5.2	M6	
KWS8-1.6	12.0	8.4	1.6	6.6	M8	
KWS12-2.5	27.0	12.8	2.5	10.4	M12	500

6

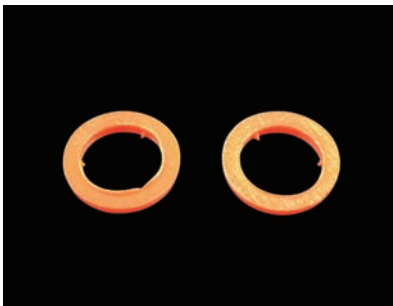

- Material: Nylon 66 (UL)
- Flame Class: 94V-2/94V-0
- Color: Natural/Black/Orange
- Unit: mm

用途：可配合M3螺絲使用之墊片。

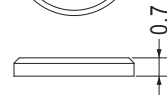
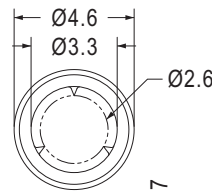

MATING SCREW: M3

Part No.	Package
KWA3-0.7	1000



- Material: Nylon 6 (UL)
- Flame Class: 94HB
- Color: Natural
- Unit: mm

用途：可配合螺絲使用之墊片。

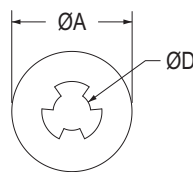

Part No.	A	C	D	Package
KWS-2.6	4.8	0.5	2.2	2000
KWS-2.6-08	4.8	0.8	2.2	
KWS-2.6-1	4.8	1.0	2.2	
KYWS-3	8.0	0.5	2.5	

螺絲墊片 SCREW WASHER

用途：可配合螺絲使用之墊片。

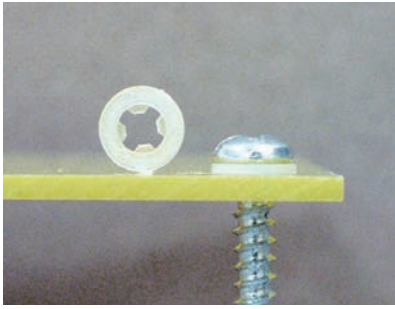

- Material: Nylon 66 (UL)
- Flame Class: 94V-2/94V-0
- Color: Natural/Black
- Unit: mm

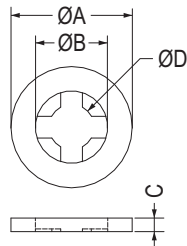

RECOMMENDED MATING SCREW: S

Part No.	A	B	C	D	S	Package
KWS-3S	5.0	4.0	0.6	2.5	M3	2000
KWS-3	6.7	4.0	0.8	2.5		
KWS-3-1.2	6.7	3.5	1.2	2.5		
KWS-4	8.0	5.0	1.0	3.3	M4	
KWS-4.6	15.0	9.5	0.9	4.6	M5	
KWS-5	15.0	9.5	0.9	5.0		
KWS-6	15.0	9.5	0.9	5.8	M6	
KWS-632	8.3	5.0	0.8	3.2	6-32 UNC	
KWS-632-1.6	8.35	4.96	1.64	3.15		

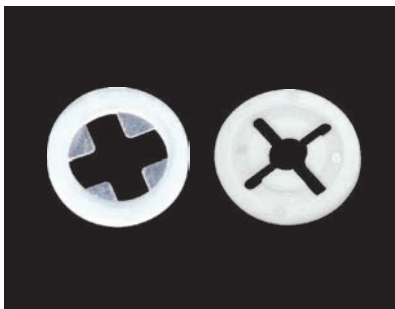

- Material: Nylon 66 (UL)
- Flame Class: 94V-2/94V-0
- Color: Natural/Black
- Unit: mm

用途：可配合螺絲使用，墊片不脫落。

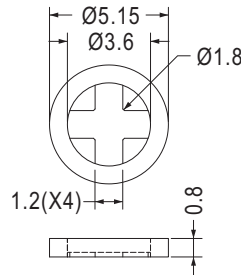

RECOMMENDED MATING SCREW: M2

Part No.	Package
KWS-2	2000

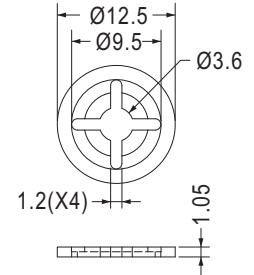

RECOMMENDED MATING SCREW: M4

Part No.	Package
KWS-3.6	2000

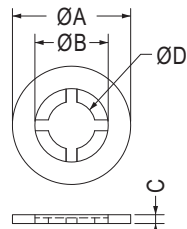
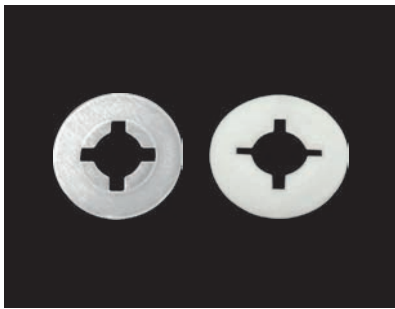

RECOMMENDED MATING SCREW: S

Part No.	A	B	C	D	S	Package
KWS832-0.8	9.91	5.97	0.81	3.43	8-32 NUC	2000
KWS-3.8	9.92	5.97	0.81	3.86	M4	
KWS-5S	11.45	7.1	0.85	4.6	M5	
KWS-5L	16.0	7.03	1.6	4.5		
KWS-8	8.5	5.8	0.9	4.4		

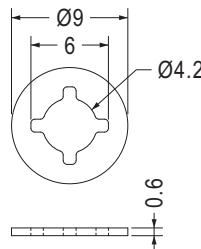
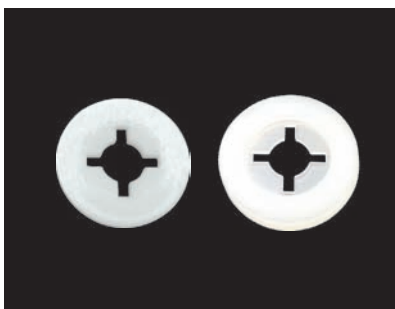

RECOMMENDED MATING SCREW: M5

Part No.	Package
KWS-4.2-0.6	2000

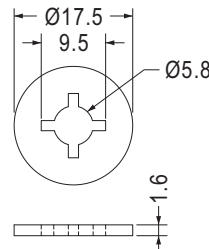

RECOMMENDED MATING SCREW: M5

Part No.	Package
KWS-6L	2000

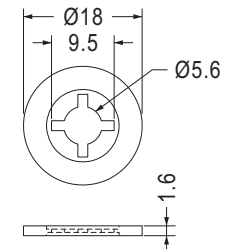

RECOMMENDED MATING SCREW: M5

Part No.	Package
KWS-6-1	2000

螺絲墊片 SCREW WASHER

用途：可配合螺絲使用之墊片。



- Material: Nylon 6 (UL)/Nylon 66 (UL)
- Flame Class: 94V-2/94V-0
- Color: Black
- Unit: mm

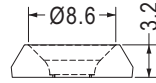
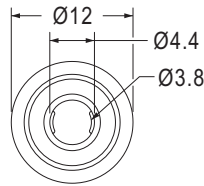

RECOMMENDED
MATING SCREW: M4

Part No.	Package
WSUB-1	1000

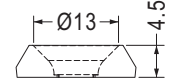
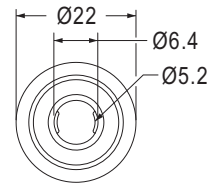

RECOMMENDED
MATING SCREW: M6

Part No.	Package
WSUB-4	500



- Material: Nylon 66 (UL)
- Flame Class: 94V-2/94V-0
- Color: Natural/Black
- Unit: mm

用途：可配合M3.5螺絲使用之墊片。

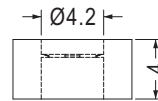
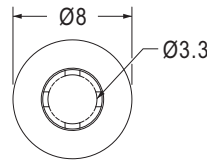

Part No.	Package
KWS4-4	1000

華司 WASHER

用途：做為零件之墊片。



- Material: Nylon 66 (UL)
- Flame Class: 94V-2/94V-0
- Color: Natural/Black
- Unit: mm

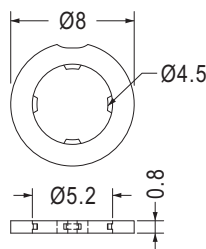

Part No.	Package
KWSA-5	1000

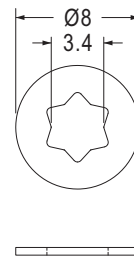

Part No.	Package
WSW8-3.4-0.5	1000

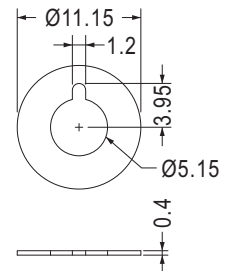

Part No.	Package
COCF-1	1000

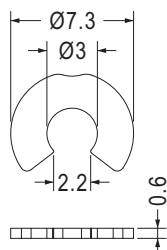

Part No.	Package
COCA3-0.6	1000

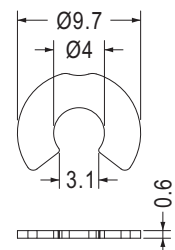

Part No.	Package
COCA4-0.6	1000

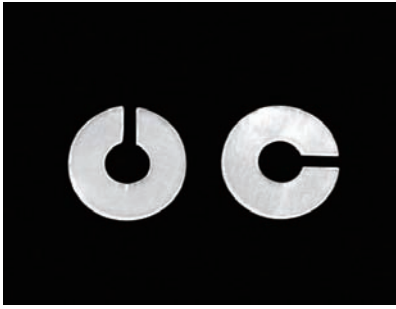

- Material: Nylon 66(UL)
- Flame Class: 94V-2/94V-0
- Color: Natural/Black
- Unit: mm

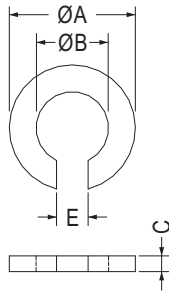

- Material: Nylon 66 (UL)/Nylon 6 (UL)/PC (UL)
- Flame Class: 94HB/94V-2/94V-0

Part No.	A	B	C	E	Package
COC2-0.5	4.0	2.3	0.5	1.0	2000
COC3-1	6.0	3.0	1.0	1.0	
COC5-4	8.0	5.0	4.0	2.5	

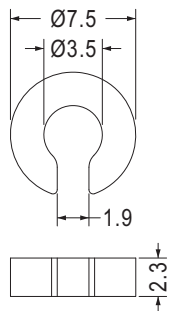

Part No.	Package
COCA3.5-2.3	2000

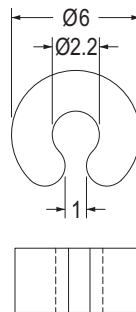

Part No.	Package
COCA2.2-3	2000



- Material: POM (UL)
- Flame Class: 94HB
- Color: Black
- Unit: mm

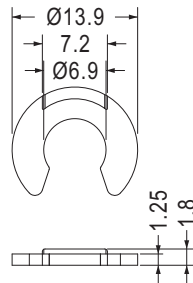

Part No.	Package
COCE-1	1000



- Material: POM (UL)
- Flame Class: 94HB
- Color: Natural/Black
- Unit: mm

用途：可配合螺絲使用之墊片。

- Material: PE
- Color: Black/Red

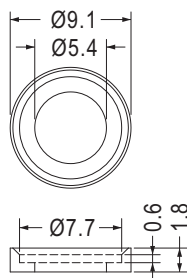

Part No.	Package
WSUA-1	2000

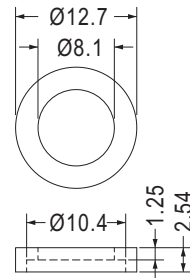

Part No.	Package
WSUA-2	2000

墊片 WASHER

用途：做為零件之墊片。



- Material: PE
- Color: Black
- Unit: mm

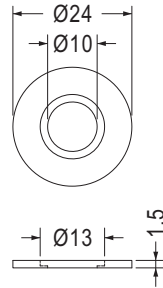

Part No.	Package
WSUC-1	1000



- Material: Nylon 66 (UL)
- Flame Class: 94V-2/94V-0
- Color: Black
- Unit: mm

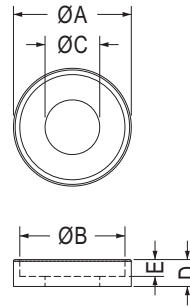

Part No.	A	B	C	D	E	Package
WSUC-2	14.0	12.5	6.5	3.2	2.0	2000
WSUC-3	12.45	9.8	4.45	3.55	2.3	

6



- Material: POM(UL)
- Flame Class: 94HB
- Color: Natural
- Unit: mm

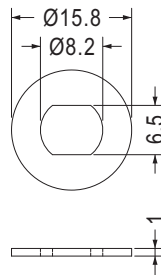

Part No.	Package
WSH-1	1000

- Material: Nylon 6 (UL)
- Flame Class: 94HB
- Color: Natural
- Unit: mm

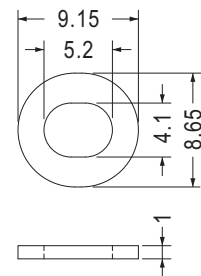

Part No.	Package
WSR9.1-8.6-1	1000



- Material: Nylon 66 (UL)
- Flame Class: 94V-2/94V-0
- Color: Natural/Black
- Unit: mm

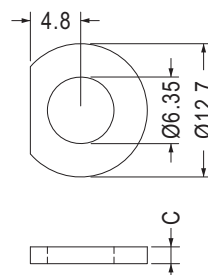

Part No.	C	Package
WSA6-1.5	1.58	1000
WSA6-6.3	6.35	

華司 WASHER

用途：可配合螺絲使用之墊片。



- Material: Nylon 66 (UL)
- Flame Class: 94V-2/94V-0
- Color: Natural/Black
- Unit: mm

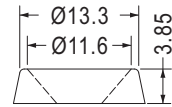
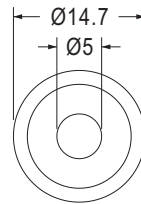

Part No.	Package
WSU-515	2000



- Material: ABS (UL)
- Flame Class: 94HB
- Color: Natural
- Unit: mm

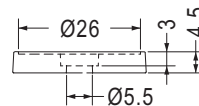
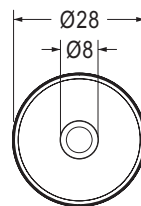

Part No.	Package
WSU-1	1000

墊片 WASHER

用途：螺絲墊片耐熱性良好。



- Material: Nylon 66 (UL)
- Flame Class: 94V-2/94V-0
- Color: Natural/Black
- Unit: mm

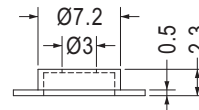
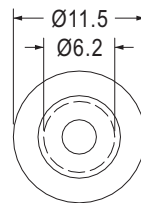

Part No.	Package
WSC-1	2000



- Material: PC (UL)
- Flame Class: 94V-2/94V-0
- Color: Natural/Black
- Unit: mm

用途：做為零件之墊片。

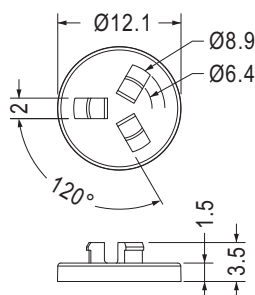

Part No.	Package
WSG-1	2000

墊片 WASHER

用途：風扇螺絲墊片抗震性良好。

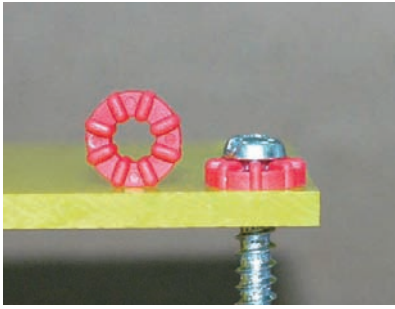

- Material: TPE
- Color: Black/Red
- Unit: mm

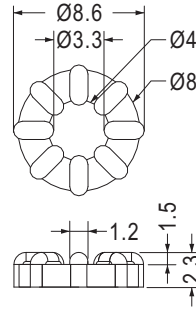

Part No.	Package
WSQ4-2	2000

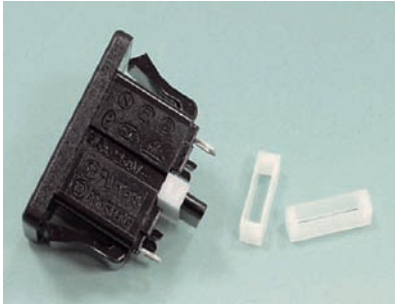

- Material: Nylon 66 (UL)
- Flame Class: 94V-2/94V-0
- Color: Natural/Black
- Unit: mm

用途：用於電源插座接點間之絕緣。

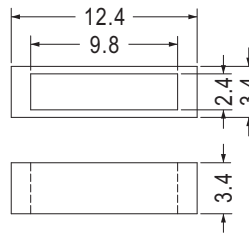

Part No.	Package
SQCP-3.4	2000

零件墊座 PARTS HOUSING

用途：做為零件之蓋片。



- Material: PBT (UL)
- Flame Class: 94V-0
- Color: Natural
- Unit: mm

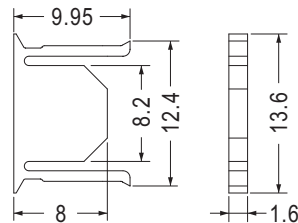

Part No.	Package
WPBT-1	1000

墊片 WASHER

用途：用於零件，如高瓦特數電阻接腳之墊高，避免熱氣積存於PC板上。

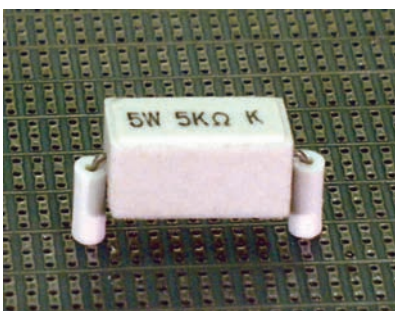

- Material: PBT (UL)
- Flame Class: 94V-0
- Color: Natural
- Unit: mm

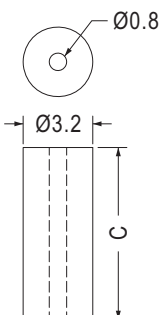

- Material: Nylon 6 (UL)
- Flame Class: 94V-2/94V-0

Part No.	C	Package
PW-14	7.9	1000
PW-16	1.5	2000

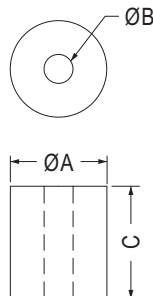

Part No.	A	B	C	Package
PW-1	4.0	1.4	4.2	2000
PW-1A	4.5	1.8	4.2	
PW-2	4.0	1.4	8.0	1000
PW-3	4.0	1.3	3.0	
PW-4	3.5	1.3	3.6	2000
PW-5	5.0	2.0	2.0	
PW-6	3.2	1.4	2.5	
PW-7	3.2	1.4	1.0	
PW-8	2.4	1.3	3.1	1000
PW-9	4.4	1.6	7.0	
PW-10	2.5	1.25	5.0	2000
PW-11	2.2	0.8	5.0	
PW-12	2.8	1.3	1.8	
PW-13	2.5	1.1	2.5	1000
PW-15	2.2	0.9	10.5	

陶瓷零件墊片 CERAMIC PARTS WASHER

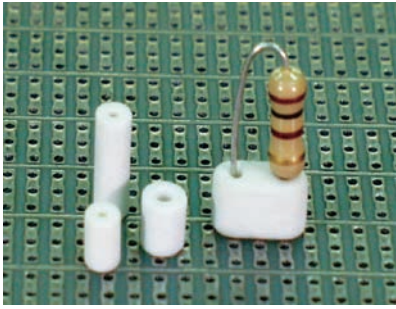

- Material: Ceramic
- Color: Natural/White
- Unit: mm

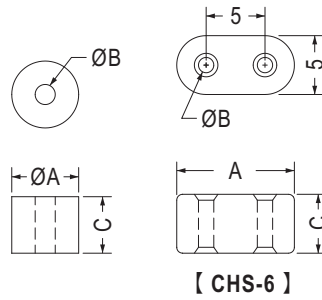

用途：用於零件，如高瓦特數電阻接腳之墊高，避免熱氣積存於PC板上。

Part No.	A	B	C	Package
CHS-1	3.8	1.0	4.5	2000
CHS-2	3.8	1.0	9.0	
CHS-3	4.5	1.8	3.0	
CHS-4	4.5	1.8	4.5	
CHS-5	4.5	1.8	9.0	
CHS-6	10.0	1.3	5.0	
CHS-7	2.6	0.9	6.9	
CHS-8	2.5	1.1	3.1	
CHS-9	4.1	1.9	15.4	
CHS-10	4.1	1.9	13.0	
CHS-18	4.0	1.6	15.0	
CHS-19	4.5	1.8	2.0	2000

電阻保護座 ELECTRIC RESISTANCE HOLDER

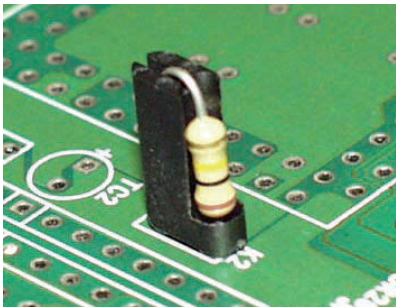

- Material: PPS (UL)
- Flame Class: 94V-0
- Color: Black
- Unit: mm

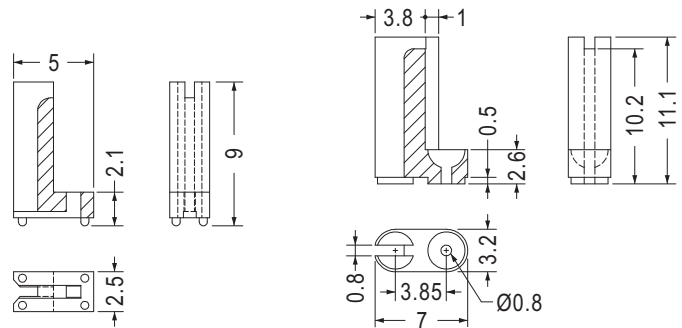

用途：用於電阻接腳之固定與保護。

Part No.	Package
RPCL-9	2000

Part No.	Package
RPCL-11	2000

零件墊座 PARTS HOUSING



- Material: Nylon 66 (UL)
- Flame Class: 94V-2/94V-0
- Color: Natural/Black
- Unit: mm

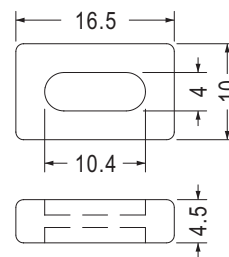

用途：用於零件之墊高。

Part No.	Package
DVT-1	1000

跳線座 JUMPER HOUSING

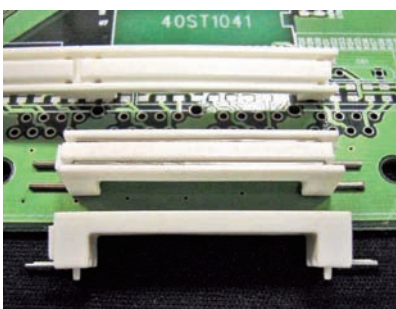

- Material: PBT (UL)
- Flame Class: 94V-0
- Color: Natural
- Unit: mm

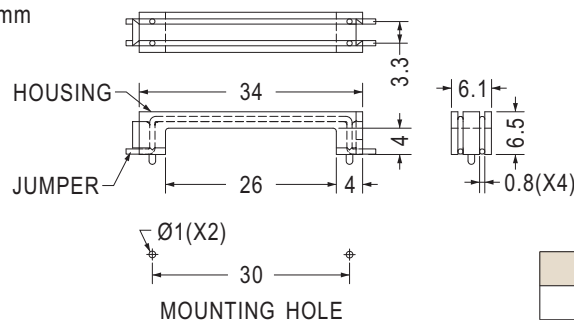

用途：立於PC板上，將兩跳線做隔離與保護固定用。

Part No.	Package
JPC-1	1000

零件墊座 PARTS HOUSING

用途：用於電感器絕緣並保護。



- Material: Nylon 66 (UL)
- Flame Class: 94V-2/94V-0
- Color: Natural/Black
- Unit: mm

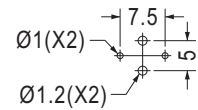
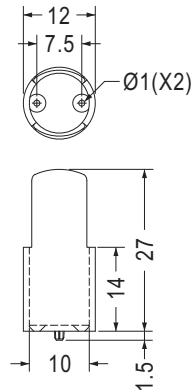

MOUNTING HOLE THICKNESS 1.6

Part No.	Package
PHC-14	500

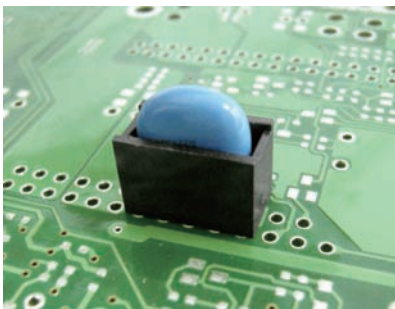

- Material: PPS (UL)
- Flame Class: 94V-0
- Color: Black
- Unit: mm

用途：用於零件之墊座。

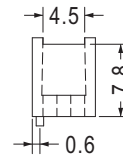
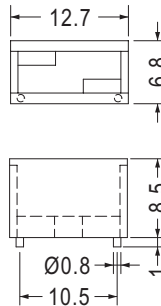

Part No.	Package
PH-26	1000



- Material: PBT (UL)/PPS (UL)
- Flame Class: 94V-0
- Color: Natural/Black
- Unit: mm

用途：用於零件接腳之墊高與保護。

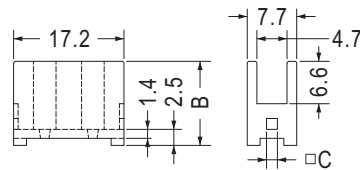
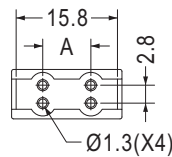

Part No.	A	B	C	Package
PHC-2	7.5	13.1	/	500
PHC-11	7.2	14.5	/	
PHC-12	7.5	13.1	1.7	



- Material: PBT (UL)
- Flame Class: 94V-0
- Color: Natural
- Unit: mm

- Material: Nylon 66 (UL)
- Flame Class: 94V-2/94V-0
- Color: Natural/Black
- Unit: mm

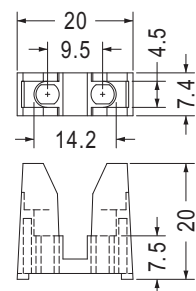
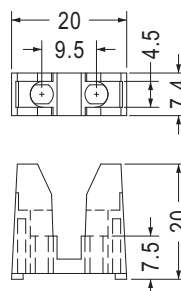

Part No.	Package
PHC-1	500

Part No.	Package
PHC8NHA	1000

零件墊座 PARTS HOUSING

用途：用於零件接腳之墊高與保護。

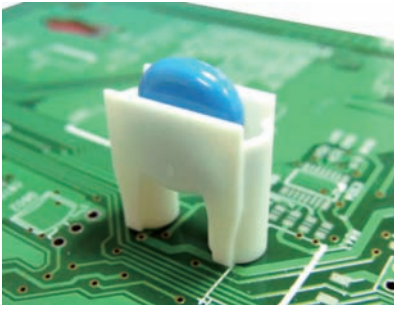

- Material: Nylon 66 (UL)
- Flame Class: 94V-2/94V-0
- Color: Natural/Black
- Unit: mm

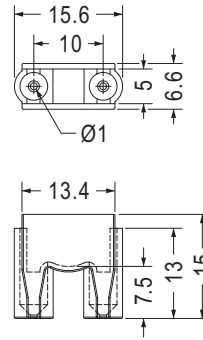

Part No.	Package
PHC-13	500

線圈座 PARTS HOUSING

用途：用於零件接腳之墊高與保護。

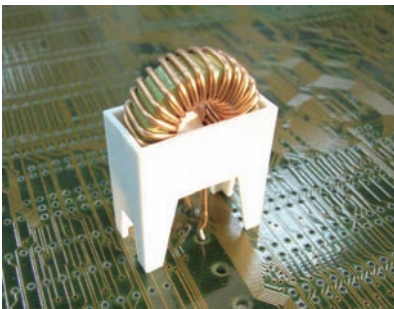

- Material: PBT (UL)
- Flame Class: 94V-0
- Color: Natural
- Unit: mm

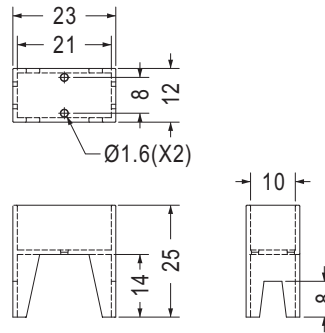

Part No.	Package
COILC-21	500

濾波器墊片 ELECTRIC FILTER WASHER

用途：用於濾波器絕緣，立於PC板上，且高度一致增加可靠度。

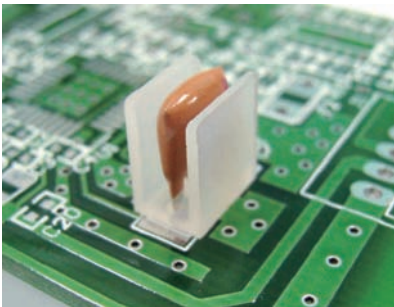

- Material: Nylon 66 (UL)
- Flame Class: 94V-2/94V-0
- Color: Natural/Black
- Unit: mm

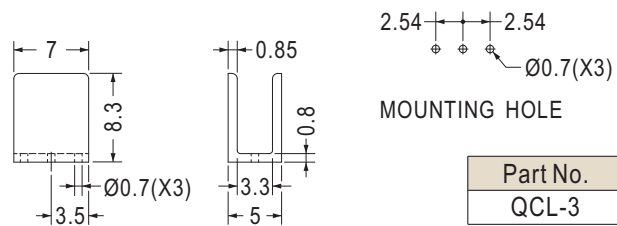

2.54 | 2.54
 $\varnothing 0.7(X3)$
 MOUNTING HOLE

Part No.	Package
QCL-3	1000

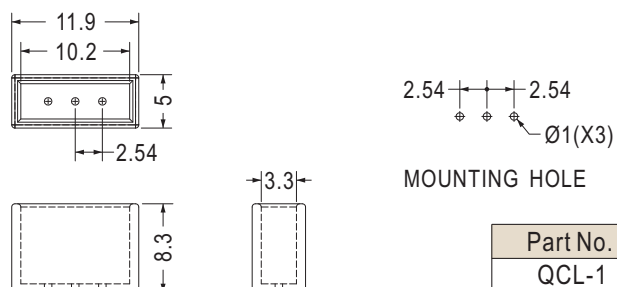

2.54 | 2.54
 $\varnothing 1(X3)$
 MOUNTING HOLE

Part No.	Package
QCL-1	1000

電容器墊片 CAPACITOR WASHER

用途：用於電容器接腳保護。



- Material: Nylon 66 (UL)
- Flame Class: 94V-2/94V-0
- Color: Natural/Black
- Unit: mm

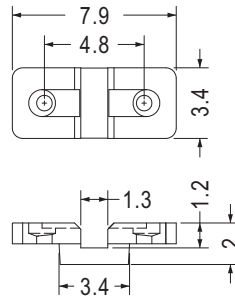

Part No.	Package
CWT-11	2000

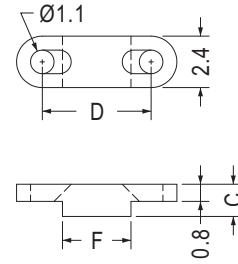

Part No.	C	D	F	Package
CWT-5	1.5	5.08	3.2	2000
CWT-8	1.2	7.6	4.0	
CWT-10	1.2	10.1	5.0	

石英晶體墊片 CRYSTAL WASHER

用途：保護石英震盪晶體立於PC板上外殼不會與PC板短路，且高度一致增加可靠度。

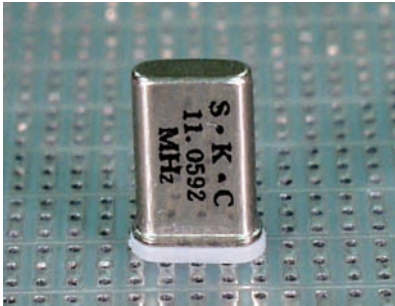

- Material: Nylon 66 (UL)
- Flame Class: 94V-2/94V-0
- Color: Natural/Black
- Unit: mm

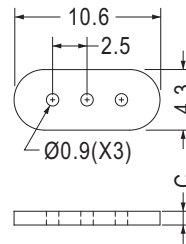

Part No.	C	Package
QW-1	1.0	2000
QW-5	0.5	

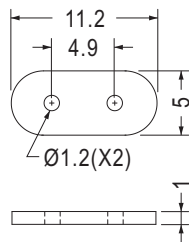

Part No.	Package
QW-3	2000

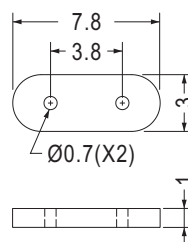

Part No.	Package
QW-6	2000

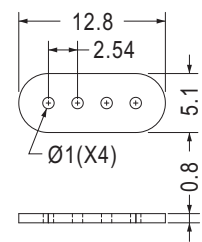

Part No.	Package
QW-8	2000

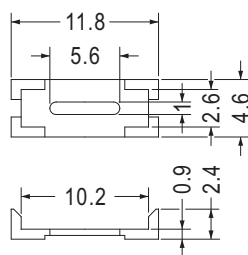

Part No.	Package
QW-2	2000

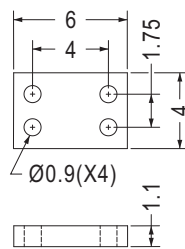

Part No.	Package
QW-7	2000

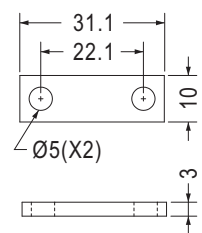

Part No.	Package
SWS311030	1000

石英晶體墊片 CRYSTAL OSCILLATOR WASHER

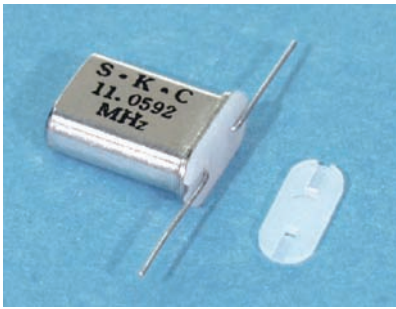

- Material: Nylon 66 (UL)
- Flame Class: 94V-2/94V-0
- Color: Natural/Black
- Unit: mm

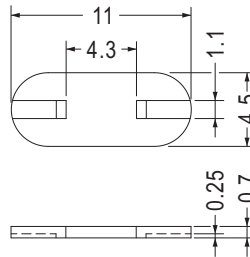

用途：保護石英震盪晶體立於PC板上外殼不會與PC板短路，且高度一致增加可靠度。

Part No.	Package
QW-4	2000

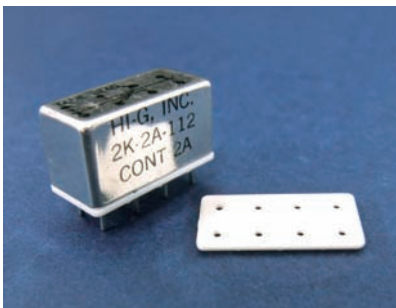

- Material: PBT (UL)
- Flame Class: 94V-0
- Color: Natural
- Unit: mm

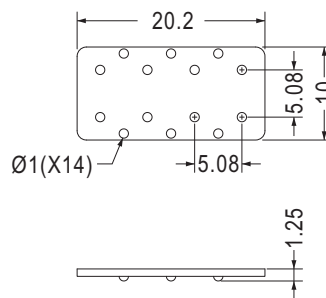

用途：用於電容器接腳保護。

Part No.	Package
PAD-1	500

電容器墊片 CAPACITOR WASHER



- Material: Nylon 66 (UL)
- Flame Class: 94V-2/94V-0
- Color: Natural/Black
- Unit: mm

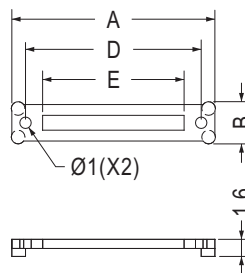

用途：用於電容器接腳保護。

Part No.	A	B	D	E	Package
CWL-15	17.8	3.7	15.5	12.4	1000
CWL-22	25.0	7.0	22.5	17.0	

電容器座 CAPACITOR HOUSING



- Material: Nylon 66 (UL)
- Flame Class: 94V-2/94V-0
- Color: Natural/Black
- Unit: mm

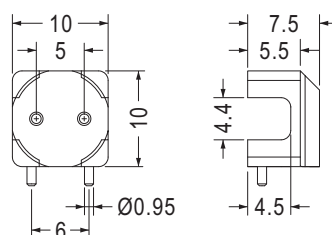

用途：用於電容器接腳保護。

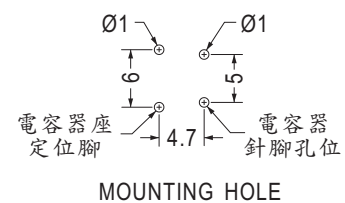

Part No.	Package
CAPH-10	1000

電容器座 CAPACITOR HOUSING

用途：用於電容器接腳保護。

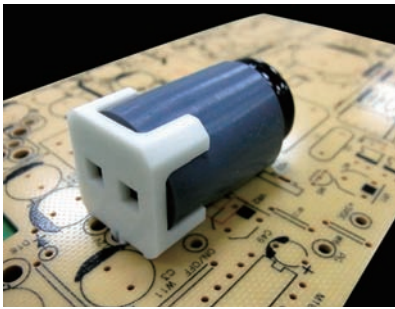

- Material: Nylon 66 (UL)
- Flame Class: 94V-2/94V-0
- Color: Natural/Black
- Unit: mm

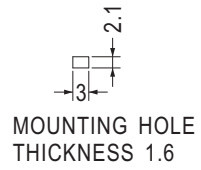
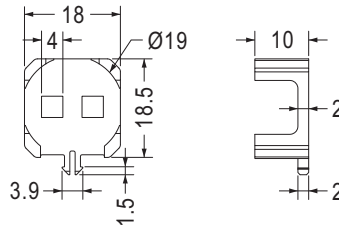

Part No.	Package
CAPI-18	500

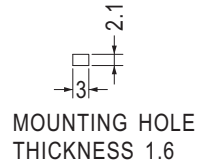
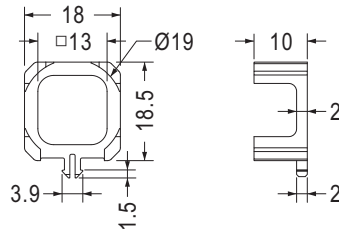
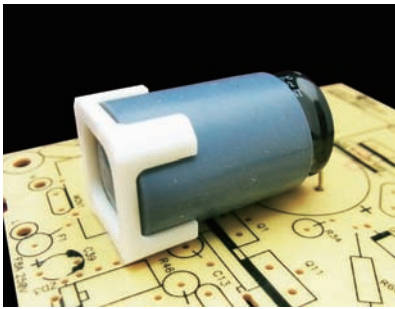

Part No.	Package
CAPJ-18	1000

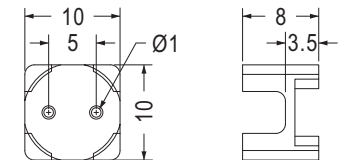
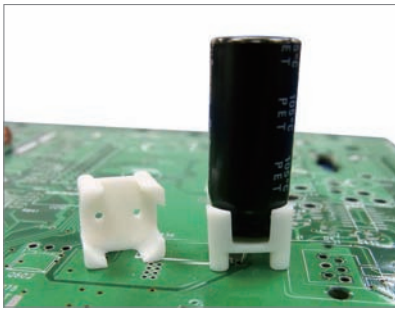

適用於 Ø10 的電容

Part No.	Package
CAPL-3.5	1000

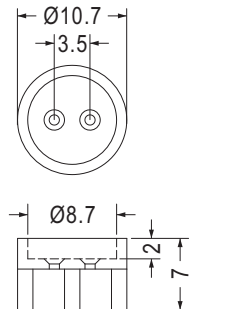

Part No.	Package
TRB-12	1000

6



- Material: Nylon 66 (UL)
- Flame Class: 94V-2/94V-0
- Color: Natural/Black
- Unit: mm

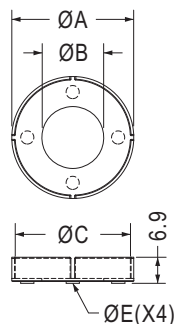

Part No.	A	B	C	E	Package
CWCD-2	27.3	13.9	25.6	3.5	500
CWCD-3	32.3	16.4	30.5	3.5	
★CWCD-4	37.3	16.4	35.8	3.5	
CWCD-5	18.3	8.9	16.6	2.7	1000
CWCD-6	20.3	8.9	18.6	2.7	
CWCD-7	12.3	6.4	10.6	2.5	

電容器座 CAPACITOR HOUSING

用途：用於電容器接腳保護。

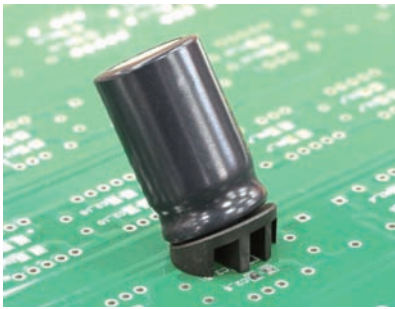

- Material: Nylon 66 (UL)
- Flame Class: 94V-2/94V-0
- Color: Natural/Black
- Unit: mm

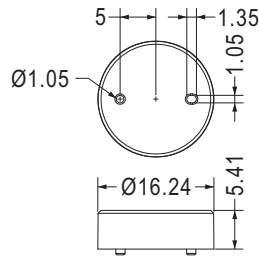

Part No.	Package
TRB-4	1000

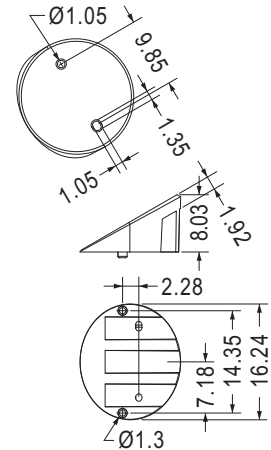

Part No.	Package
TRB-3	1000

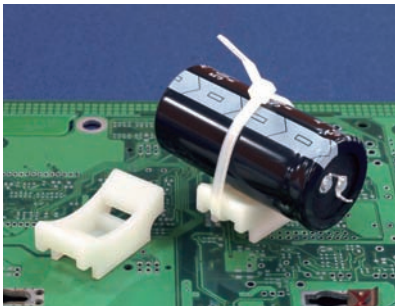

- Material: Nylon 66 (UL)
- Flame Class: 94V-2/94V-0
- Color: Natural/Black
- Unit: mm

用途：用於電容器接腳保護，配合束線帶固定使用。

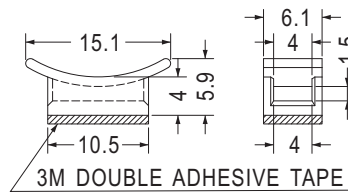

Part No.	Package
THMB-1	1000

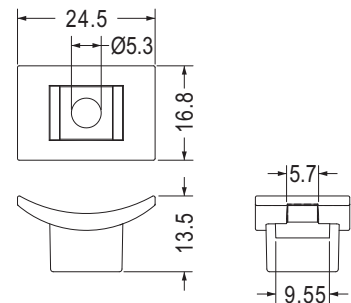

Part No.	Package
THMB-2	1000

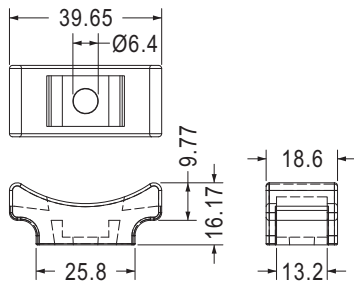

Part No.	Package
THMB-3	1000

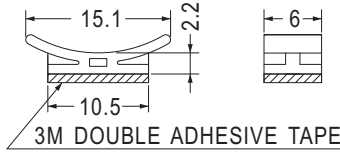

Part No.	Package
THMC-1	1000

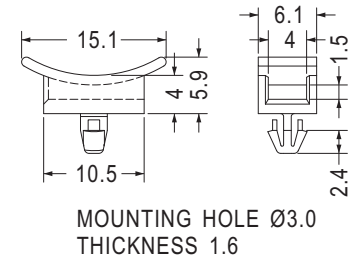

MOUNTING HOLE Ø3.0
THICKNESS 1.6

Part No.	Package
THMK-1	1000

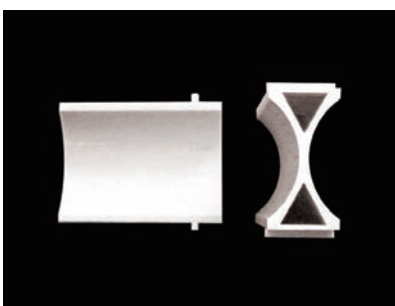

- Material: ABS (UL)
- Flame Class: 94HB
- Color: Gray
- Unit: mm

用途：用於電容器固定。

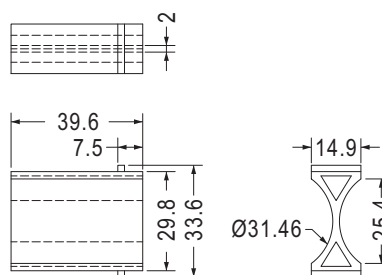

Part No.	Package
KYPC-40	250

電容器固定座 CAPACITOR MOUNT

用途：固定電容器於機板上，維修方便，不佔空間。



- Material: Nylon 66 (UL)
- Flame Class: 94V-2/94V-0
- Color: Natural/Black
- Unit: mm

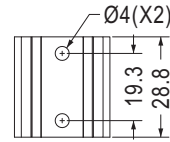
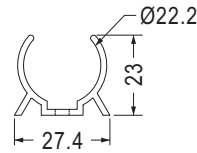

WALL THICKNESS 1.7

Part No.	Package
WLLC-1	500

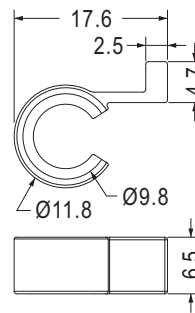

Part No.	Package
CWCK-10	1000

電容器座 CAPACITOR HOUSING

用途：配合束線帶固定用。

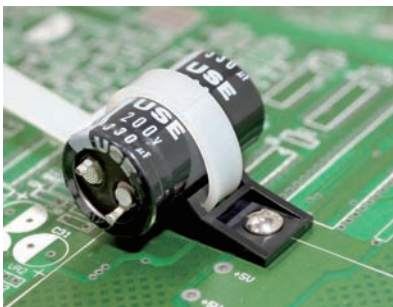

- Material: Nylon 66 (UL)
- Flame Class: 94V-2/94V-0
- Color: Natural/Black
- Unit: mm

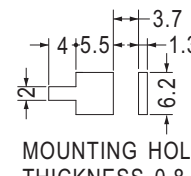
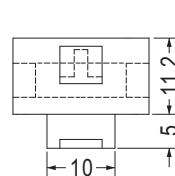
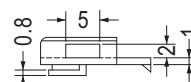
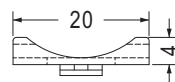

MOUNTING HOLE THICKNESS 0.8

Part No.	Package
MTAC-1	500

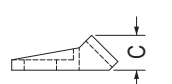
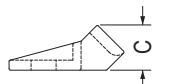
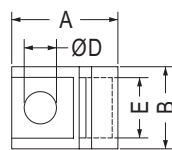
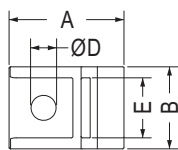

【 MTAB-4, MTAB-6 】

Mounting Screw Size

Part No.	A	B	C	D	E	Screw Size	Package
MTAB-4	19.0	11.3	8.0	4.2	8.3	M4	1000
MTAB-5	17.4	13.5	5.7	5.3	10.1	#10	
MTAB-6	23.0	16.4	9.04	5.2	12.0	M5	500
MTAB-10	27.4	21.4	10.3	8.4	16.7	5/16	



- Material: Nylon 66 (UL)
- Flame Class: 94V-2/94V-0
- Color: Natural/Black
- Unit: mm

用途：用於電容器固定。

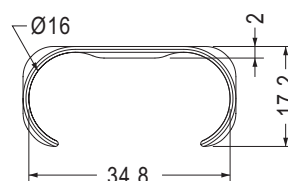

Part No.	Package
DELT-20	100

電容器固定座 CAPACITOR MOUNT

用途：用於電容器固定。

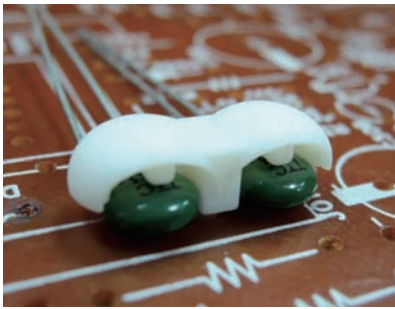

- Material: Nylon 66 (UL)
- Flame Class: 94V-2/94V-0
- Color: Natural/Black
- Unit: mm

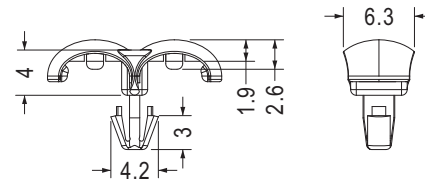

MOUNTING HOLE $\varnothing 3.0$
CHASSIS THICKNESS 1.5

Part No.	Package
CLDK-1	1000

電容器墊片 CAPACITOR WASHER

用途：用於大電容器之墊座。



- Material: Nylon 66 (UL)
- Flame Class: 94V-2/94V-0
- Color: Natural/Black
- Unit: mm

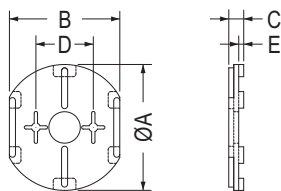
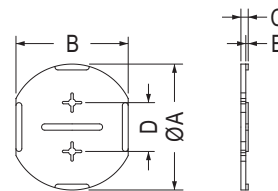

【 CW-1 】

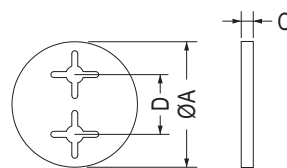

【 CW-10S 】

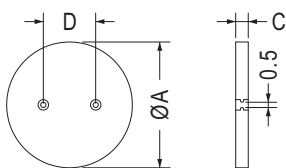

【 CW-12 】

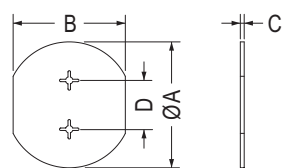

【 CW-25S 】

Part No.	A	B	C	D	E	Package
CW-1	22.8	19.8	2.7	10.4	0.9	500
CW-10S	10.5	/	1.0	5.0	/	1000
CW-12	12.0	/	1.2	5.5	/	
CW-16	16.2	14.6	1.5	7.5	0.5	
CW-18	18.2	16.4	1.5	7.5	0.5	
CW-22	22.2	20.0	1.5	10.0	0.5	500
CW-25	25.7	23.0	1.5	10.0	0.5	
CW-25S	25.7	23.0	0.8	10.0	/	
CW-30	30.3	27.2	1.5	10.0	0.5	
CW-35	35.3	31.8	1.5	10.0	0.5	
CW-35L	35.3	31.8	2.0	10.0	1.0	

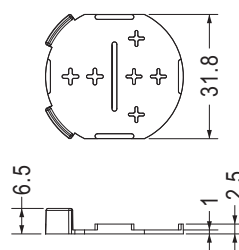

Part No.	Package
CW-2	1000

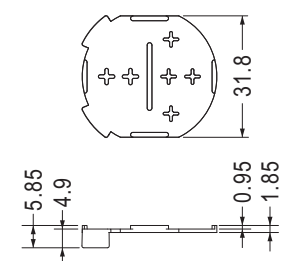

Part No.	Package
CW-3	1000

電容器墊片 CAPACITOR WASHER

用途：用於電容器接腳保護。

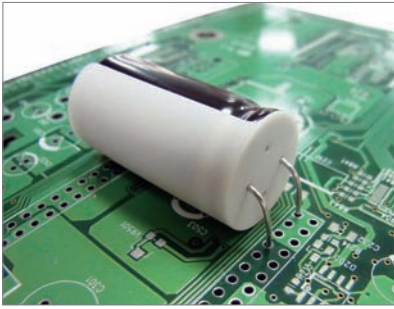

- Material: Nylon 66 (UL)
- Flame Class: 94V-2/94V-0
- Color: Natural/Black
- Unit: mm

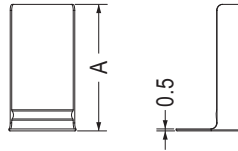
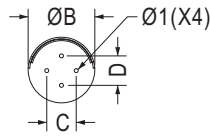

Part No.	A	B	C	D	Package
CWCA-10	24.5	11.2	5.0	5.0	1000
CWCA-16	31.8	16.5	7.4	7.4	

電容器蓋 CAPACITOR COVER

用途：用於電容器之絕緣與保護。



- Material: Nylon 66 (UL)
- Flame Class: 94V-2/94V-0
- Color: Natural/Black
- Unit: mm

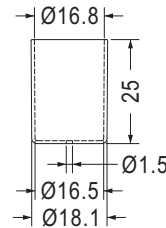
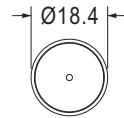

Part No.	Package
BCB-16	500

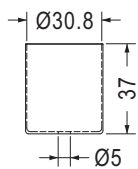
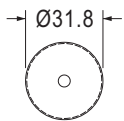

Part No.	Package
BCB-30	100

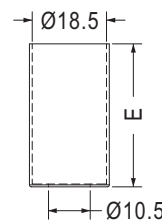
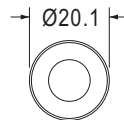

NEW

Part No.	E	Package
BCBA-18	40.5	200
BCBA-18-1	36.0	

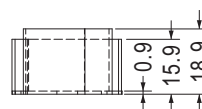
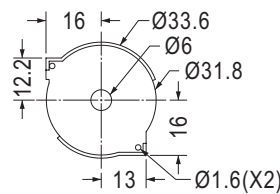

Part No.	Package
BASE-L5	1000

電容器帽套 CAPACITOR COVER

用途：用於大電容器之絕緣與保護。



- Material: Nylon 66 (UL)
- Flame Class: 94V-2/94V-0
- Color: Natural/Black
- Unit: mm

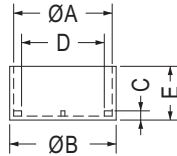
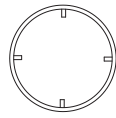

Part No.	A	B	C	D	E	Package
BCC-10.3	10.3	11.3	0.8	8.3	6.4	500
BCC-13	13.2	14.2	2.5	10.2	15.0	
BCC-16S	16.5	17.5	1.5	12.4	20.0	
BCC-16	16.7	18.2	1.75	13.7	10.2	
BCC-18	18.7	20.2	1.75	15.7	10.2	
BCC-22	22.2	23.4	1.05	18.0	8.0	2000
BCC-25	26.0	27.2	0.75	22.0	8.0	500
BCC-27	27.0	28.2	1.05	23.0	15.0	2000

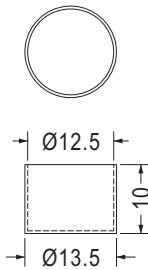

- Material: Silicon Rubber (UL)
- Flame Class: 94V-0
- Color: Black

Part No.	Package
BCCA-1210	500

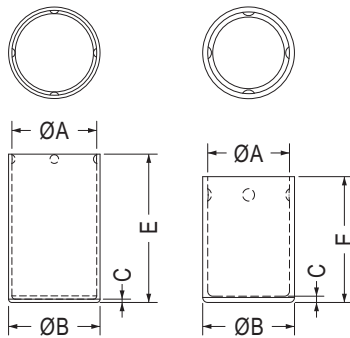
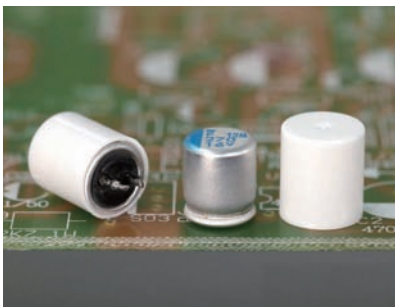

【 BCCA10.3-18 】

Part No.	A	B	C	E	Package
BCCA6.3-10	6.5	7.3	0.5	10.0	1000
BCCA6.3-12	6.5	7.3	0.4	12.0	
BCCA8-10	8.2	9.0	0.5	10.0	
BCCA8-13.4	8.2	9.0	0.4	13.4	
BCCA10.3-18	10.3	11.1	0.4	18.0	

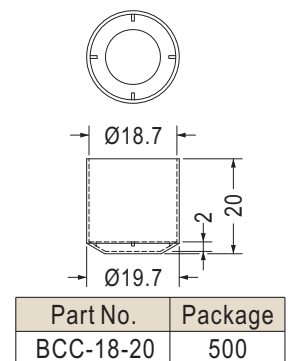
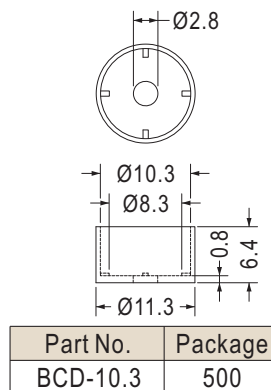

陶瓷零件墊片 CERAMIC PAD

用途：用於零件之絕緣散熱，散熱性佳。

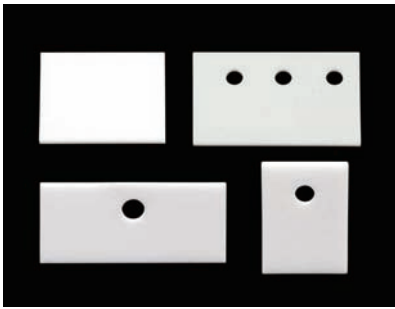

- Material: Ceramic
- Color: Natural
- Unit: mm

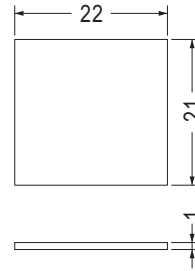

Part No.	Package
CHSA-1	100

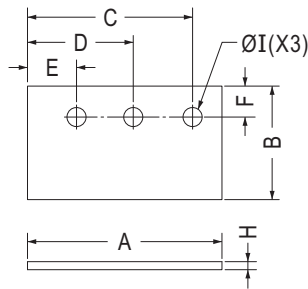

Part No.	A	B	C	D	E	F	H	I	Package
CHSA-2	37.7	22.0	32.0	20.5	9.5	6.0	1.55	3.7	50
CHSA-4	34.8	20.0	28.8	17.3	5.8	4.0	1.0	3.7	100
CHSA-5	42.0	20.0	33.8	20.2	6.0	4.0	1.0	3.7	50
CHSA-6	30.0	13.6	/	15.0	/	4.5	1.0	3.5	100
CHSA-7	16.0	21.0	/	8.0	/	5.9	2.5	3.5	

散熱陶瓷墊片 CERAMIC HEAT SINK

用途：用於零件之絕緣散熱，散熱性佳。



- Material: Ceramic
- Color: White
- Unit: mm

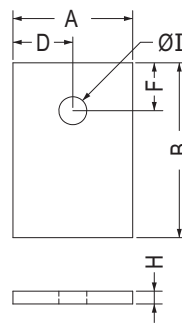

Part No.	A	B	D	F	H	I	Package
TO-3PAWO	15.0	21.9	7.5	6.0	1.6	3.5	200
TO-220AWO	13.7	19.0	6.85	5.0	2.0	3.8	100

6

矽膠片 SILICON INSULATOR

用途：鎖於功率晶體與散熱片之間導熱、絕緣性特佳。



- Material: Silicon (UL)
- Flame Class: 94HB/94V-0
- Color: Gray
- Unit: mm

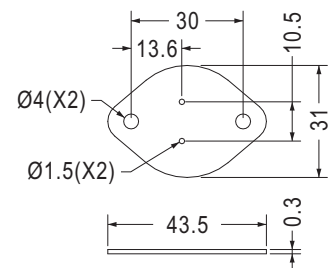
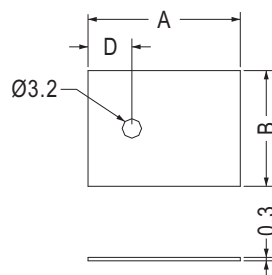

Part No.	A	B	D	Package
TO-3P	25.0	19.0	7.2	1000
TO-220	19.0	13.2	5.0	

Part No.	Package
TO-3	1000

CPU散熱矽膠片 CPU THERMAL TRANSFER SILICON PAD



- Material: Silicon (UL)
- Flame Class: 94V-0
- Color: Gray
- Unit: mm
- Thickness: 0.5~4.0mm

用途：CPU或手提電腦散熱用，可用背膠(單面或雙面)，尺寸可依客戶要求。

Customized Size is available.

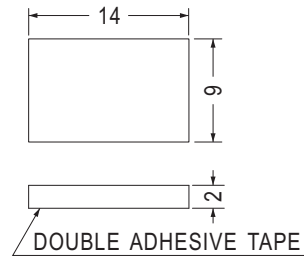

Part No.
CPU140920A

矽膠帽套 SILICON INSULATOR COVER

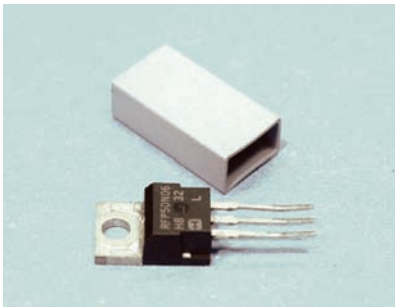

- Material: Silicon (UL)
- Flame Class: 94HB/94V-0
- Color: Gray
- Unit: mm

用途：固定於功率晶體與散熱片之間，絕緣性特佳。

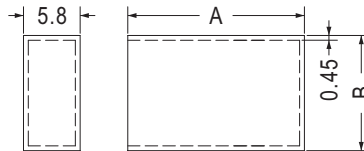

Part No.	A	B	Package
TO-3PCV	28.5	17.5	1000
TO-3PCV-C	25.0	17.5	
TO-220CV	21.7	11.5	

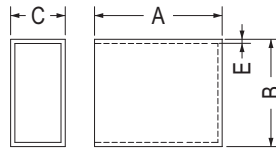

Part No.	A	B	C	E	Package
SRT-111158	11.0	11.5	5.8	0.45	2000
SRT-111758	16.0	11.4	5.5	0.45	
SRT-182864	28.5	18.0	6.4	0.75	1000
SRT-203464	35.0	20.0	6.4	0.75	

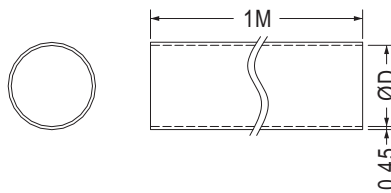
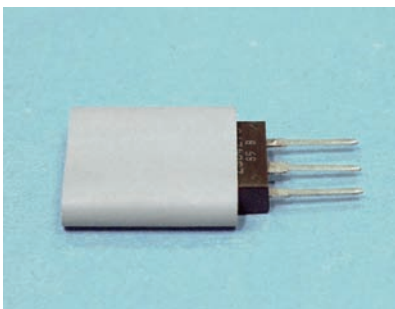

Part No.	D
SRT6	6.0
SRT8	8.0
SRT10	10.0
SRT12	12.0
SRT14	14.0
SRT16	16.0
SRT18	18.0



- Material: Silicon (UL)
- Flame Class: 94HB/94V-0
- Color: Gray
- Unit: mm

用途：用於大電解電容之外殼絕緣絕緣性特佳。

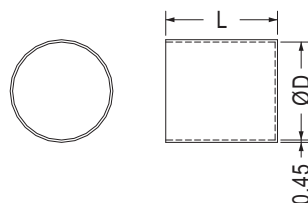

Part No.	D	L	Package
SCT-0726	7.8	26.0	500
SCT-1315	13.0	15.0	
SCT-1615	16.7	15.0	
SCT-1825	18.5	25.0	

電池蓋 BATTERY COVER

用途：用於電池蓋之防塵與保護。



- Material: Silicon Rubber (UL)
- Flame Class: 94V-0
- Color: Black
- Unit: mm

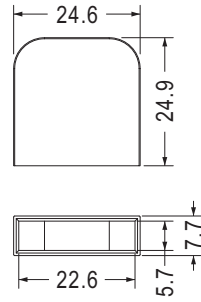

Part No.	Package
SRTA-1	1000

保險絲蓋 FUSE COVER

用途：用於保險絲之絕緣與防塵。



- Material: Soft P.V.C
- Color: Blue/Black
- Unit: mm



- 如需UL認可材質，請在料號尾碼加UL下單
- Please add UL after Part Number for UL certified material.

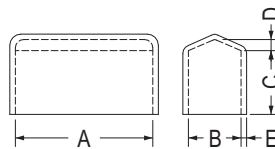

Part No.	A	B	C	D	E	Package
FH-1	20.0	6.0	11.0	1.0	1.2	1000
FH-1L	22.0	6.0	11.0	1.0	1.5	
FH-1S	18.0	5.3	9.0	1.0	1.0	
FH-3A	31.8	9.1	12.0	1.5	1.2	
FH-3	31.8	9.5	13.0	1.5	1.3	
FH-4	41.0	12.8	19.0	2.0	1.2	
FHC-5	19.0	3.3	10.0	1.0	1.2	

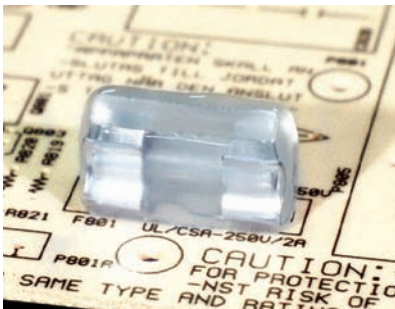

- Material: Soft P.V.C
- Color: Natural
- Unit: mm

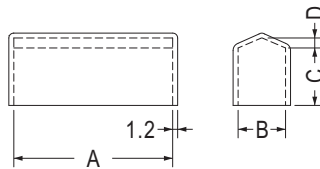

Part No.	A	B	C	D	Package
FUSE-1	20.0	6.0	11.0	1.0	1000
FUSE-2	31.8	9.5	13.0	1.5	500
FUSE-3	36.1	8.1	9.9	1.0	1000

6



- Material: Nylon 66 (UL)
- Flame Class: 94V-2/94V-0
- Color: Natural/Black
- Unit: mm

用途：用於SMT保險絲蓋之防塵與保護。

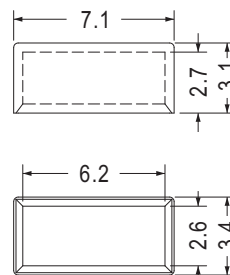

Part No.	Package
FUSEA-1	1000



- Material: Soft P.V.C
- Color: Black
- Unit: mm

用途：用於保險絲之絕緣與防塵。

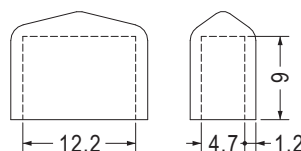

Part No.	Package
FH-13	1000

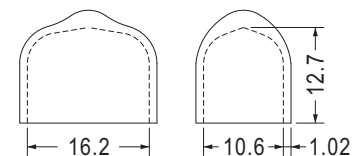

- Color: Blue

Part No.	Package
FH-17	1000

電容器護套 CAPACITOR COVER

用途：用於電容器之絕緣與防塵。



- Material: Soft P.V.C
- Color: Natural
- Unit: mm

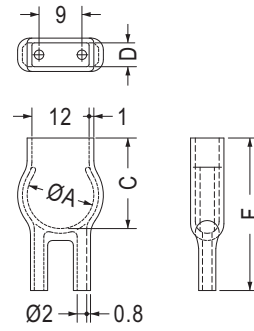
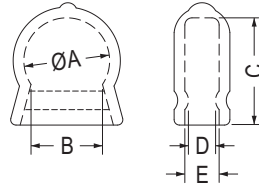

- 如需UL認可材質，請在料號尾碼加UL下單
- Please add UL after Part Number for UL certified material.

Part No.	A	B	C	D	E	Package
HU-8	8.5	7.5	10.0	3.0	3.0	1000
HU-10	10.5	9.0	12.3	3.0	4.0	
HU-12	12.0	10.0	15.0	3.8	4.8	

- 如需UL認可材質，請在料號尾碼加UL下單
- Please add UL after Part Number for UL certified material.

Part No.	A	C	D	F	Package
HU-14	14.0	16.0	4.0	22.0	1000
HU-16	16.0	19.0	5.0	32.0	

末端套管 VCP CAP

用途：用於連接器之絕緣與防塵。



- Material: Soft P.V.C
- Color: Black
- Unit: mm

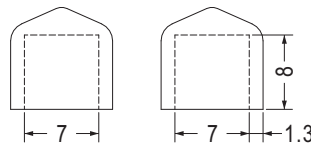

Part No.	Package
VC0707008	1000

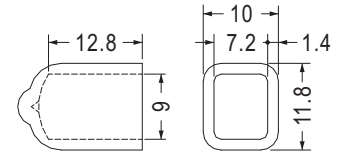

Part No.	Package
VC907413	500



- Material: Soft P.V.C
- Color: Natural/Red/Black/Yellow/
Green/Blue/White
- Unit: mm

用途：特殊管末端切開時之保護套及各種電線，電纜運送途中防濕防塵用。

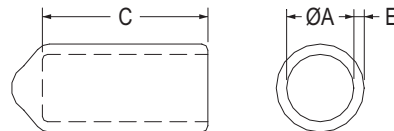

Part No.	A	C	E	Package
VCP02012	2.0	12.0	0.8	2000
VCP02607	2.6	7.0	0.8	
VCP02608	2.6	8.0	0.8	
VCP02609	2.6	9.0	0.8	
VCP03206	3.2	6.0	0.8	
VCP03210	3.2	10.0	0.8	
VCP03213	3.2	13.0	0.8	
VCP04006	4.0	6.0	0.8	1000
VCP04008	4.0	8.0	0.8	
VCP04809	4.8	9.0	1.0	
VCP04813	4.8	13.0	0.8	
VCP05708	5.7	8.0	1.0	
VCP05710	5.7	10.0	1.0	
VCP05713	5.7	13.0	1.0	
VCP06008	6.0	8.0	1.0	
VCP06012	6.0	12.0	1.0	

Part No.	A	C	E	Package
VCP06513	6.5	13.0	1.0	1000
VCP07013	7.0	13.0	1.0	
VCP07020	7.0	20.0	1.0	
VCP07608	7.6	8.0	1.0	
VCP07613	7.6	13.0	1.0	
VCP08008	8.0	8.0	1.0	
VCP08010	8.0	10.0	1.0	
VCP08509	8.5	9.0	1.0	
VCP08515	8.5	15.0	1.0	
VCP09516	9.5	16.0	1.0	
VCP10020	10.0	20.0	1.0	500
VCP11420	11.4	20.0	1.2	
VCP12016	12.0	16.0	1.2	
VCP14035	14.0	35.0	1.2	
VCP15014	15.0	14.0	1.2	
VCP17813	17.8	13.0	1.2	
VCP22016	22.0	16.0	1.2	200

末端套管 VCP CAP



- Material: TPE (UL)
- Flame Class: 94HB
- Color: Black
- Unit: mm

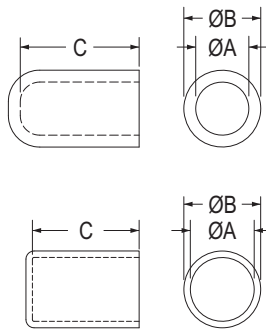

【 KS079132 】

用途：特殊管末端切開時之保護套及各種電線，電纜運送途中防濕防塵用。

Part No.	A	B	C	Package
KSK024066	2.4	5.6	6.6	1000
KSK024122	2.4	6.3	12.2	
KSK029122	2.9	6.3	12.2	
KSK032097	3.2	5.5	9.7	
KSK032142	3.2	7.0	14.2	
KSK040130	4.0	5.5	13.0	2000
KSK040970	4.0	5.5	9.7	
KSK070105	7.0	11.0	10.5	1000
KSK070130	7.0	9.8	13.0	
KSK070180	7.0	9.8	18.0	
KS079132	7.9	9.5	13.2	
★KSK080242	8.0	10.5	24.2	

軟質端子保護套 TERMINAL SOFT SLEEVES



- Material: Soft P.V.C
- Color: Red/White/Black/Blue/
Yellow/Green
- Unit: mm

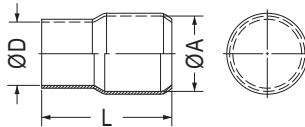

用途：用於端子壓著後端子與外界間之絕緣，可作為線材之分色標記，安全美觀。

Part No.	Wire mm ²	A	D	L	Package
V-1.25	1.25	3.3	3.1	15.0	100
V-2	2.0	4.5	3.7	16.0	
V-3.5	3.5	5.7	4.1	18.0	
V-5.5	5.5	5.7	5.2	20.0	
V-8	8.0	7.2	6.2	21.0	
V-14	14.0	10.0	8.0	28.0	
V-22	22.0	12.0	9.5	29.0	

Part No.	Wire mm ²	A	D	L	Package
V-38	38.0	14.0	11.8	34.0	100
V-60	60.0	17.0	13.9	42.0	
V-70	70.0	17.9	15.1	45.0	
V-80	80.0	19.5	16.0	46.0	
V-100	100.0	22.0	18.0	55.0	
V-125	125.0	24.4	20.0	60.0	50
V-150	150.0	26.0	22.0	65.0	
V-185	185.0	29.0	24.0	66.7	
V-200	200.0	32.2	24.0	69.0	
V-250	250.0	37.5	26.5	75.0	
V-325	325.0	37.5	30.0	75.0	25
V-400	400.0	45.1	37.5	83.0	
V-500	500.0	48.2	40.2	85.0	
V-630	630.0	53.8	45.2	93.0	



- Material: Soft P.V.C
- Color: Natural/Blue
- Unit: mm

用途：用於端子壓著後端子與外界間之絕緣。

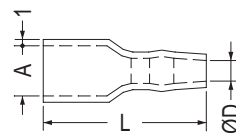

FLAT INSULATING SLEEVES

- 如需UL認可材質，請在料號尾碼加UL下單
- Please add UL after Part Number for UL certified material.

- 如需UL認可材質，請在料號尾碼加UL下單
- Please add UL after Part Number for UL certified material.

SERIES-110					
Part No.	A	D	L	Wire Size(O.D)	Package
S4020	4.0	2.0	22.0	2.0	1000
S4025	4.0	2.5	22.0	2.5	
S4028	4.0	2.8	22.0	2.8	
S4030	4.0	3.0	22.0	3.0	
S4035	4.0	3.5	22.0	3.0	
SERIES-187					
Part No.	A	D	L	Wire Size(O.D)	Package
S5825	5.8	2.5	22.0	2.5	1000
S5830	5.8	3.0	22.0	3.0	
S5835	5.8	3.5	22.0	3.5	
S5840	5.8	4.0	22.0	3.5	

SERIES-205					
Part No.	A	D	L	Wire Size(O.D)	Package
S6525	6.5	2.5	24.0	2.5	1000
S6530	6.5	3.0	24.0	3.0	
S6530/37	6.5	3.0	37.0	3.0	
S6535	6.5	3.5	24.0	3.5	
S6540	6.5	4.0	24.0	4.0	
SERIES-250					
Part No.	A	D	L	Wire Size(O.D)	Package
S8030	7.8	3.0	26.0	3.0	1000
S8035	7.8	3.5	27.0	3.5	
S8040	8.0	4.0	27.0	4.0	
S8045	8.0	4.5	27.0	4.5	
S8050	7.8	5.0	27.0	5.0	
S9535	9.5	3.5	26.0	3.5	

軟質端子保護套 TERMINAL SOFT SLEEVES

用途：用於端子壓著後端子與外界間之絕緣。



- Material: Soft P.V.C
- Color: Natural/Blue
- Unit: mm

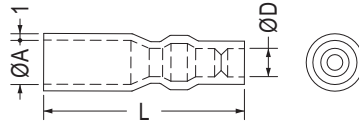

Part No.	A	D	L	Package
R4028/38	5.0	2.8	32.0	1000
R5025	5.0	2.5	33.0	
R5028	5.0	2.8	33.0	
R5030	5.0	3.1	33.0	
R5035	5.2	3.5	33.0	
R5040	5.5	4.0	33.0	



- Material: Soft P.V.C
- Color: Natural
- Unit: mm

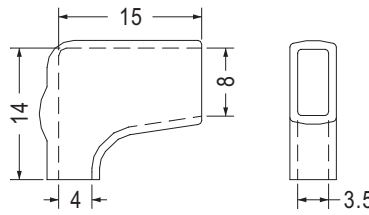

WIRE SIZE(O.D) Ø4.0

Part No.	Package
F8040	1000

PC端子保護套 TERMINAL HOUSING

用途：用於電池端子之絕緣與保護。

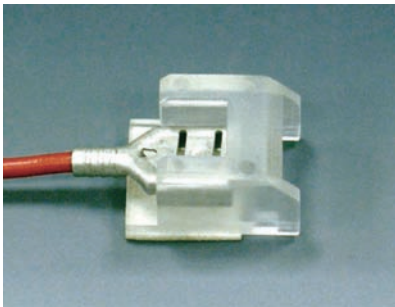

- Material: PC (UL)
- Flame Class: 94V-2
- Color: Natural
- Unit: mm

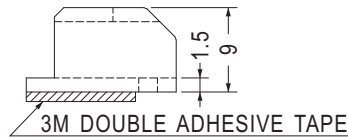
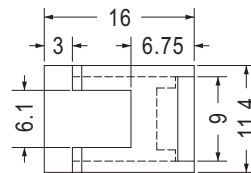

Part No.	Package
PCTT-1	1000

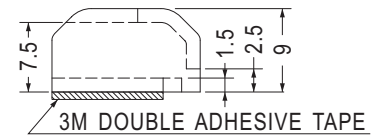
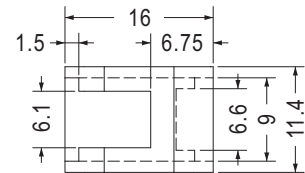

Part No.	Package
PCTT-2	1000

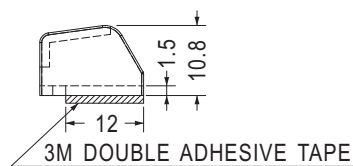
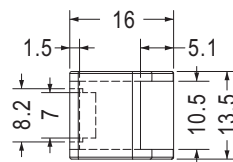

Part No.	Package
PCTT-3	1000

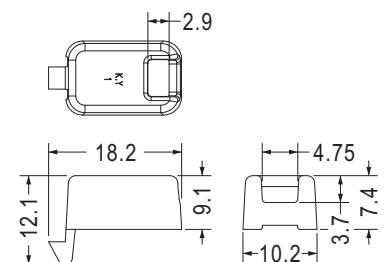

Part No.	Package
CVER-1	1000

保護蓋 INSULATED CAP

用途：用於HUB掛載孔之防塵與絕緣。



- Material: Nylon 66 (UL)/PC (UL)
- Flame Class: 94V-2/94V-0
- Color: Black
- Unit: mm

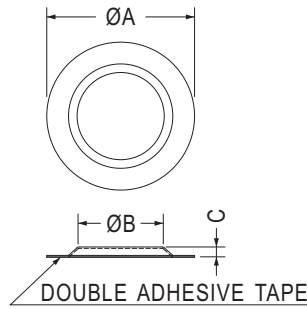

Part No.	A	B	C	Package
SCD-1	24.0	15.0	2.0	1000
SCD-2	31.5	18.0	2.4	
SCD-3	32.0	22.0	2.4	
SCD-4	37.0	22.0	2.5	500
SCD-8	26.0	18.6	2.3	2000
SCD-13	55.0	40.0	3.5	500
SCD-14	32.0	22.4	3.7	1000



- Material: Nylon 66 (UL)
- Flame Class: 94V-2/94V-0
- Color: Black
- Unit: mm

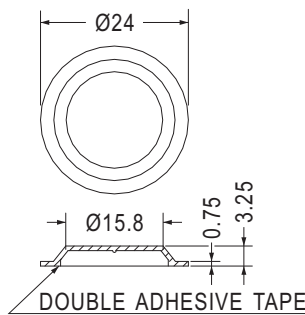

Part No.	Package
SCD-6	2000

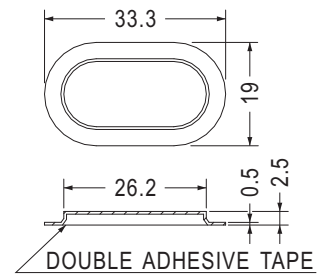

Part No.	Package
SCD-5	1000

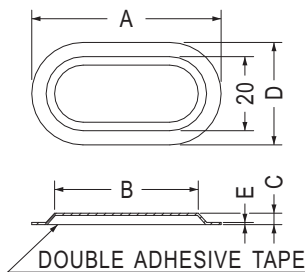

Part No.	A	B	C	D	E	Package
SCD-7	51.7	39.23	3.0	28.0	0.6	2000
SCD-15	42.0	24.6	4.5	24.0	0.5	1000

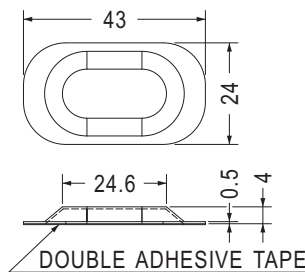

Part No.	Package
SCD-10	2000

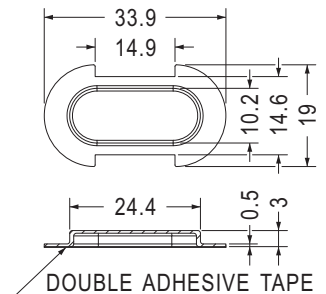

Part No.	Package
SCD-12	2000



- Material: PC (UL)
- Flame Class: 94V-2/94V-0
- Color: Black
- Unit: mm

用途：用於維修用孔之防塵與絕緣，可用螺絲固定。

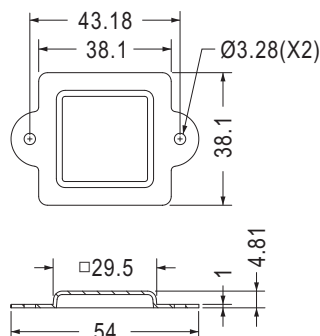

Part No.	Package
SCD-9	2000

保護蓋 INSULATED CAP

用途：用於零件之防塵與保護。



- Material: Nylon 66 (UL)
- Flame Class: 94V-2/94V-0
- Color: Natural/Black
- Unit: mm

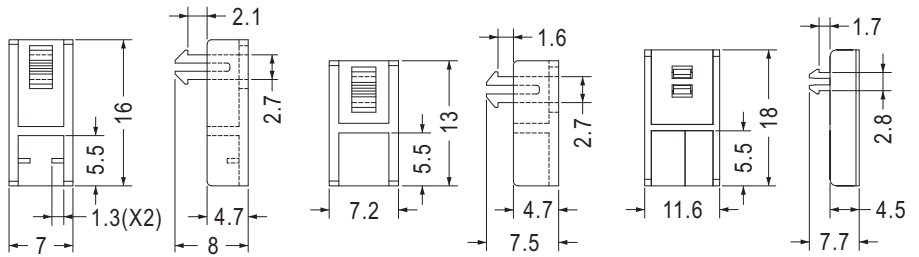

Part No.	Package
PH-25	1000

Part No.	Package
PH-41	1000

Part No.	Package
COVER-5	1000

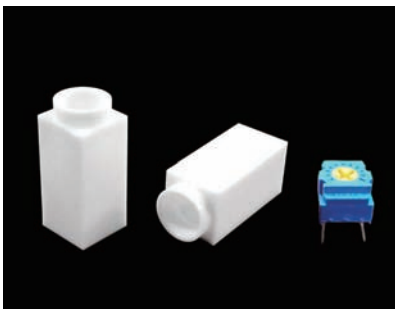

- Material: Nylon 66 (UL)
- Flame Class: 94V-2/94V-0
- Color: Natural/Black
- Unit: mm

用途：用於機器之可調電阻，灌膠之保護，可配合MHD系列使用。

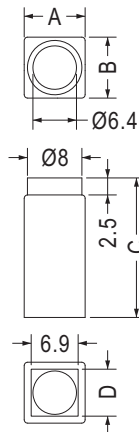

Part No.	A	B	C	D	Package
VRCVA-18	8.95	8.95	20.5	6.9	100
VRCVA-21.4	8.95	8.95	23.9	6.9	
VRCVA-27.5	8.95	8.95	30.0	6.9	
VRCVA-33	8.9	8.6	35.5	6.6	

開關蓋 TACT SWITCH CAP

用途：用於開關之加長與保護。

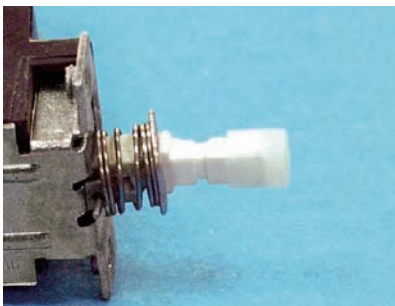

- Material: Nylon 66 (UL)
- Flame Class: 94V-2/94V-0
- Color: Natural/Black
- Unit: mm

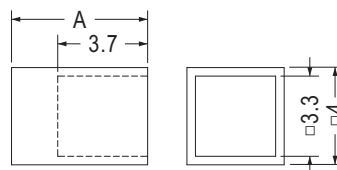

Part No.	A	Package
SWC-1	5.6	2000
SWC-2	4.7	



- Material: PC+ABS (UL)
- Flame Class: 94V-2/94V-0
- Color: White
- Unit: mm

用途：用於開關之帽蓋。

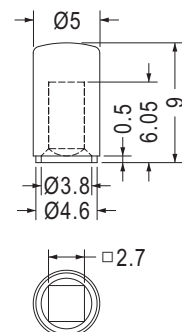
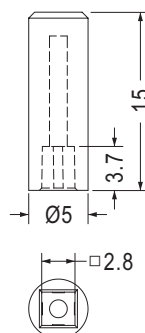

- Color: Black

Part No.	Package
TSC-22	1000

Part No.	Package
TSC-23	1000

開關蓋 TACT SWITCH CAP

用途：用於TACT開關之帽蓋。

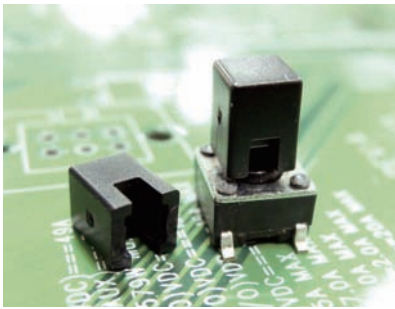

- Material: ABS (UL)
- Flame Class: 94HB
- Color: Black
- Unit: mm

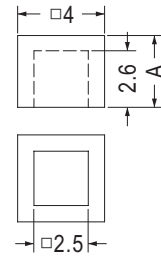
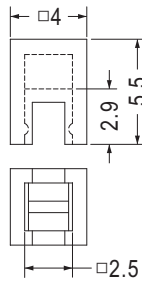

Part No.	Package
TSC-1	1000

Part No.	A	Package
TSC-2	3.3	2000
TSC-2A	4.0	

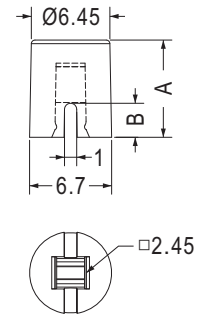
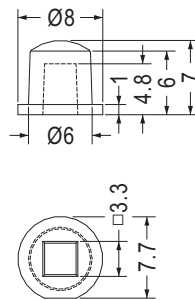
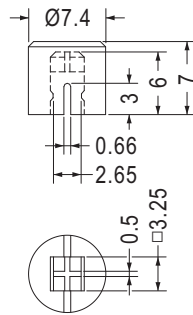

Part No.	Package
TSC-10	1000

Part No.	Package
TSC-11	1000

Part No.	A	B	Package
TSC-8	6.0	2.5	1000
TSC-46	8.0	2.8	

- Material: Nylon 66 (UL)
- Flame Class: 94V-2/94V-0
- Color: Natural/Black
- Unit: mm

6



- Material: Nylon 66 (UL)
- Flame Class: 94V-2/94V-0
- Color: Natural/Black/Red/Gray
- Unit: mm

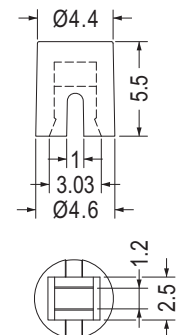
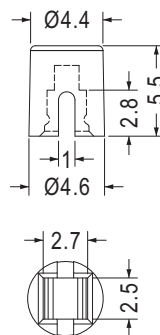
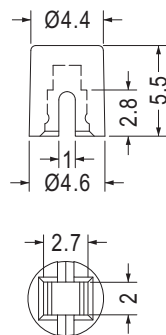

Part No.	Package
TSC-19	1000

Part No.	Package
TSC-33	1000

Part No.	Package
TSC-32	1000

- Material: ABS (UL)
- Flame Class: 94HB
- Color: Black/White
- Unit: mm

開關蓋 TACT SWITCH CAP

用途：將TACT開關固定於機板上。



- Material: ABS (UL)
- Flame Class: 94HB
- Color: Black
- Unit: mm

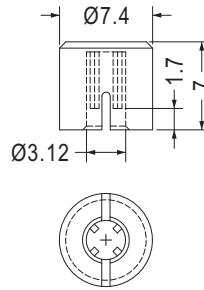

Part No.	Package
TSC-40	1000

- Material: ABS
- Color: White
- Unit: mm

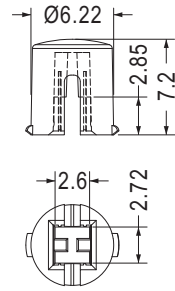

Part No.	Package
TSC-45	1000



- Material: Nylon 66 (UL)
- Flame Class: 94V-2/94V-0
- Color: Natural/Black
- Unit: mm

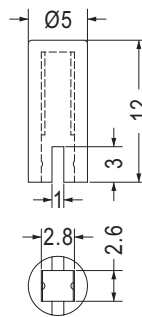

Part No.	Package
TSC-26	1000

- Material: ABS (UL)
- Flame Class: 94V-0
- Color: Natural/Black
- Unit: mm

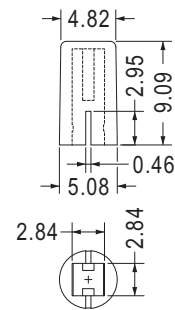

Part No.	Package
TSC-49	2000



- Material: Nylon 66 (UL)/ABS (UL)
- Flame Class: 94HB/94V-2/94V-0
- Color: Natural/Black
- Unit: mm

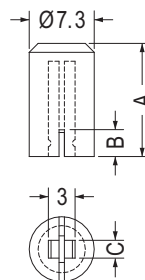

Part No.	A	B	C	Package
TSC-4	12.7	3.0	2.0	1000
TSC-5	12.7	4.2	3.0	
TSC-25	11.6	3.0	2.0	

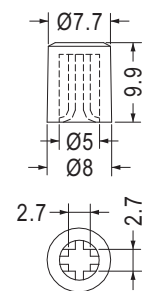

Part No.	Package
TSC-6	1000

端子蓋 CONNECTOR COVER

用途：用於端子之絕緣。



- Material: Nylon 66 (UL)
- Flame Class: 94V-2/94V-0
- Color: Natural/Black
- Unit: mm

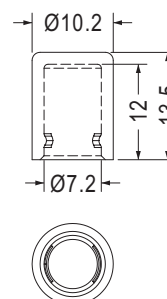

Part No.	Package
TSC-28	1000

測試針遮蓋 TEST PIN CAP

用途：把多餘PIN腳遮蓋，避免刺傷工作人員。

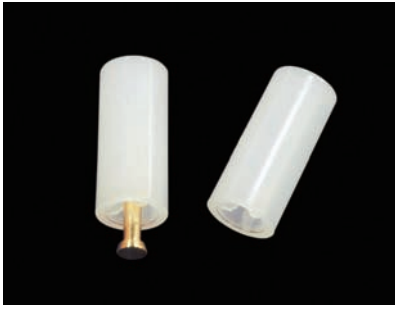

- Material: Nylon 66 (UL)
- Flame Class: 94V-2/94V-0
- Color: Natural/Black
- Unit: mm

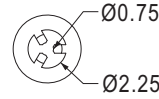
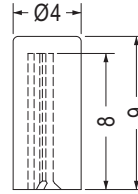

Part No.	Package
TSC-42	1000

開關蓋 TACT SWITCH CAP

用途：用於TACT開關之帽蓋。



- Material: Nylon 66 (UL)
- Flame Class: 94V-2/94V-0
- Color: Natural/Black
- Unit: mm

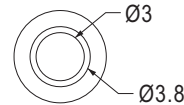
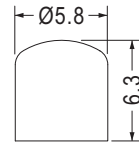

Part No.	Package
PENCOMC-1	1000

6



- Material: Nylon 66 (UL)
- Flame Class: 94V-2/94V-0
- Color: Natural/Black
- Unit: mm

用途：用於開關之按鍵。

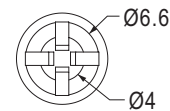
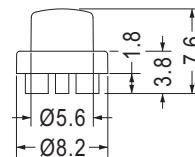

Part No.	Package
TSC-20	1000



- Material: PC+ABS (UL)
- Flame Class: 94V-0
- Color: Black/Gray
- Unit: mm

用途：用於開關之帽蓋。

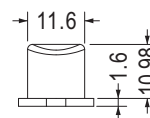
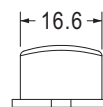
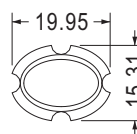

Part No.	Package
TSC-9	1000

開關蓋 TACT SWITCH CAP

用途：用於TACT開關之帽蓋。

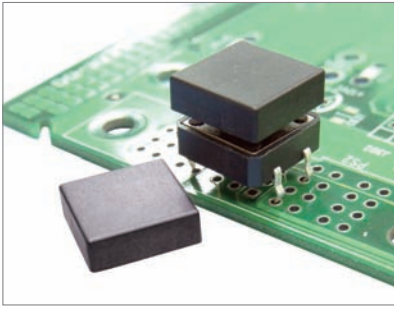

- Material: ABS (UL)
- Flame Class: 94HB
- Color: Black
- Unit: mm

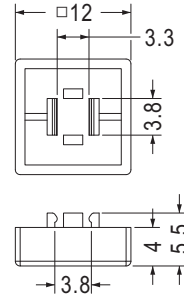
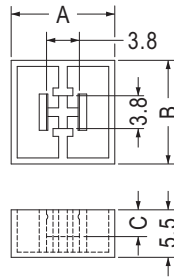

Part No.	A	B	C	Package
TSC-3	12.0	12.0	3.1	1000
TSC-18	9.0	9.0	2.8	

Part No.	Package
TSC-36	1000

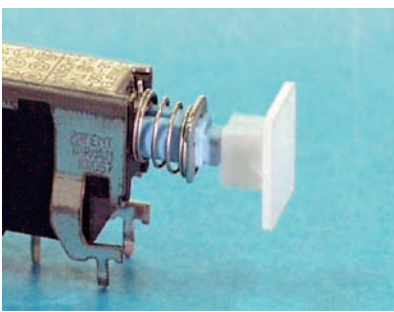

- Material: Nylon 66 (UL)/PC+ABS (UL)
- Flame Class: 94V-2/94V-0
- Color: Natural/Black/Gray
- Unit: mm

用途：用於開關之帽蓋。

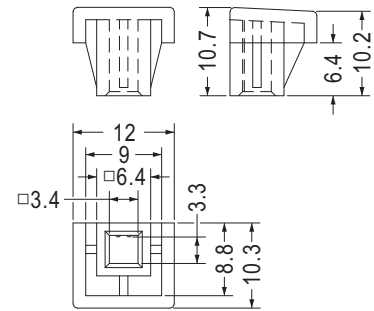
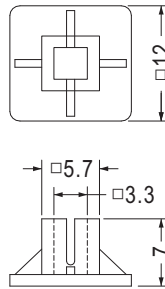

Part No.	Package
SWCL-7	1000

Part No.	Package
SWCL-10	1000

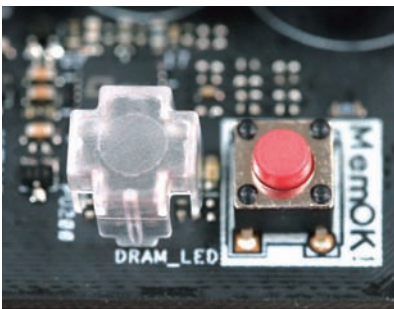

- Material: PC (UL)
- Flame Class: 94V-2
- Color: Transparent
- Unit: mm

用途：防止TACT開關之誤觸。

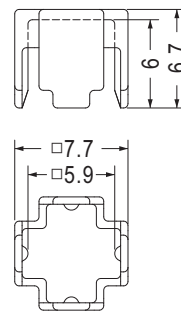

Part No.	Package
TSC-38	1000

LED按鍵蓋 LED PUSHBUTTON CAP

用途：用於LED按鍵蓋。



- Material: PC (UL)
- Flame Class: 94V-2
- Color: Transparent
- Unit: mm

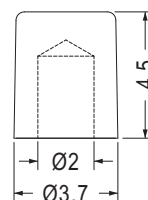

Part No.	Package
LEM-72	1000

開關蓋 SWITCH COVER

用途：用於電源插座防塵與保護。



- Material: PVC
- Color: Transparent
- Unit: mm

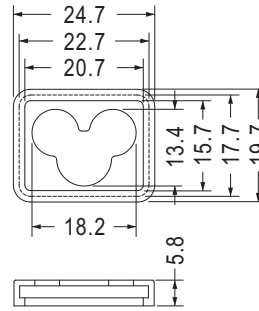

Part No.	Package
ABSC-2318	1000

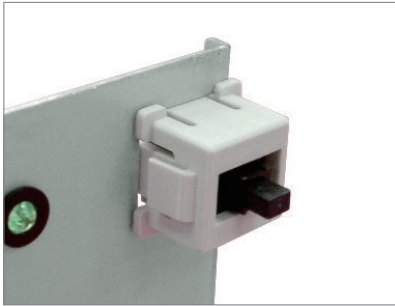

- Material: PC+ABS (UL)
- Flame Class: 94V-0
- Color: Natural/Black
- Unit: mm

用途：將TACT開關固定於機板上。

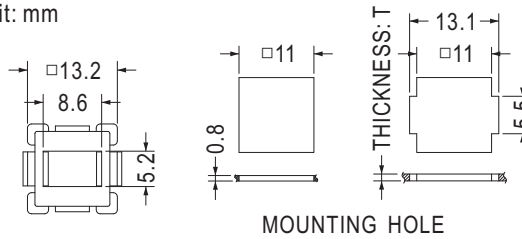

MOUNTING HOLE

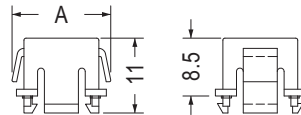

Part No.	A	T	Package
TSC-7	14.5	1.0	1000
TSC-7L	14.3	1.4	

- Material: ABS (UL)
- Flame Class: 94HB
- Color: Natural/Computer
- Unit: mm

- Material: ABS (UL)
- Flame Class: 94HB/94V-0
- Color: Natural/Black/Computer
- Unit: mm

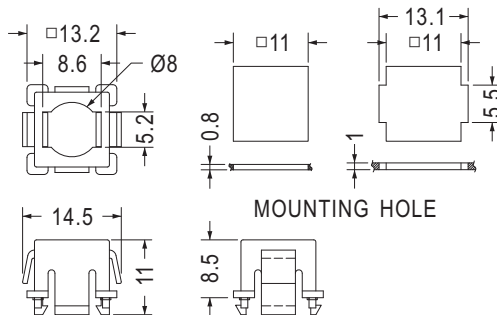

MOUNTING HOLE

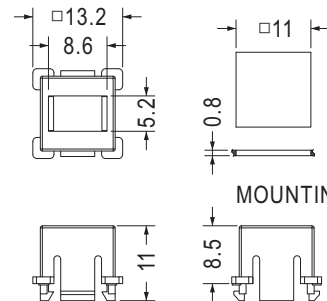

MOUNTING HOLE

Part No.	Package
TSC-7T	1000

Part No.	Package
TSC-7Y	1000

- Material: PC+ABS (UL)
- Flame Class: 94V-2/94V-0
- Color: Natural/Black
- Unit: mm

- Material: ABS (UL)
- Flame Class: 94HB
- Color: Black
- Unit: mm

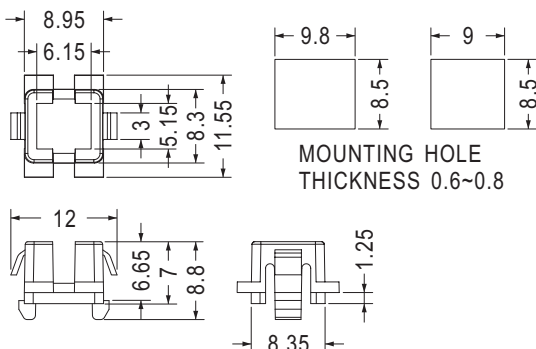

MOUNTING HOLE
THICKNESS 0.6~0.8

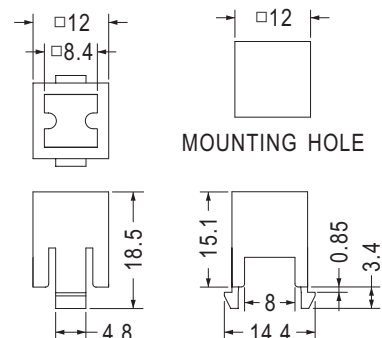

MOUNTING HOLE

Part No.	Package
TSC-27	1000

Part No.	Package
TSC-24	1000

麥克風或電容套 MIC OR CAPACITOR CAP

用途：用於麥克風或電容之帽套，防止共振。



- Material: Rubber/Silicon Rubber (UL)
- Flame Class: 94V-0
- Color: Black
- Unit: mm

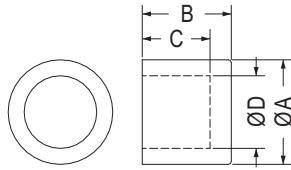

Part No.	A	B	C	D	Package
MIC-3	10.8	9.2	7.0	7.5	1000
MIC-44	9.6	10.0	9.5	8.6	

麥克風套 MIC HOLDER

用途：用於麥克風之帽套，防止共振。



- Material: Rubber/Silicon Rubber
- Color: Black
- Unit: mm

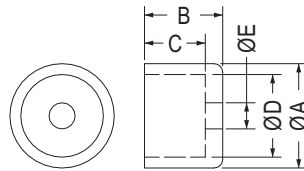

Part No.	A	B	C	D	E	Package
MIC-1	12.0	8.6	7.0	9.5	3.0	1000
MIC-1A	12.5	9.0	7.0	9.5	3.0	
MIC-4	8.0	6.0	5.0	5.8	3.0	2000
MIC-9	7.1	3.3	2.5	6.0	4.0	
MIC-32	7.1	4.7	4.0	6.0	4.0	1000
MIC-36	10.5	6.8	6.0	10.0	4.0	
MIC-38	25.1	12.0	10.9	22.8	16.1	

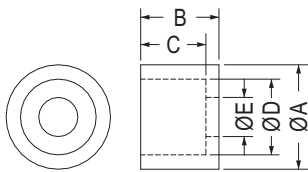

- Material: Rubber/Silicon Rubber (UL)
- Flame Class: 94V-0

Part No.	A	B	C	D	E	Package
MIC-5	8.0	4.0	3.0	6.0	2.8	2000
TF-1556	8.6	6.8	6.5	8.0	5.6	

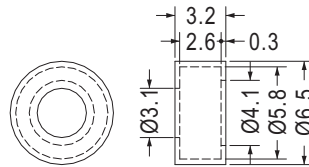

Part No.	Package
MIC-6	2000

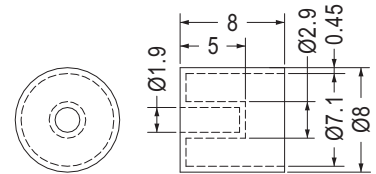

Part No.	Package
MIC-10	2000

矽膠蓋 SILICON RUBBER CAP

用途：用於零件之保護，防塵美觀。



- Material: Silicon Rubber (UL)
- Flame Class: 94V-0
- Color: Black
- Unit: mm

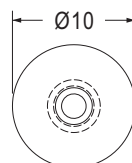
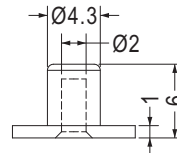

Part No.	Package
TF-1198	1000

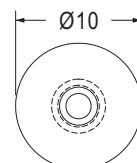
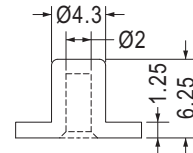

Part No.	Package
TF-1679	1000

矽膠蓋 SILICON RUBBER CAP

用途：用於零件之保護，防塵美觀。



- Material: Silicon Rubber
- Color: Black
- Unit: mm

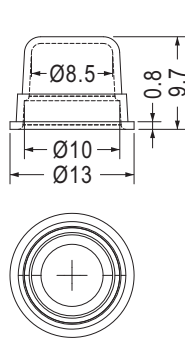

Part No.	Package
TF-1639	1000

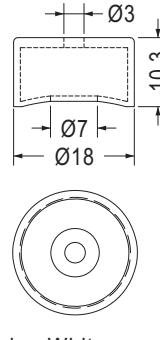

- Color: White

Part No.	Package
TF-1575	1000

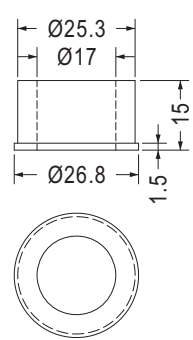

Part No.	Package
MIC-39	1000

麥克風座 MIC HOLDER

用途：用於麥克風座，可降低雜音、噪音。

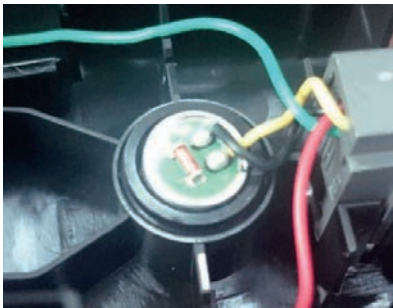

- Material: PE
- Color: Black
- Unit: mm

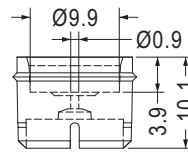
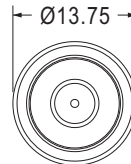

Part No.	Package
MIC-31	1000

開關蓋 TACT SWITCH CAP

用途：開關之絕緣。



- Material: PE
- Color: Black
- Unit: mm

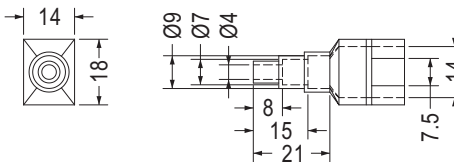
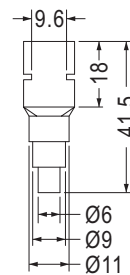

Part No.	Package
EM-19	500

絕緣蓋 INSULATOR COVER

用途：用於波段開關旋鈕。



- Material: Nylon 66 (UL)
- Flame Class: 94V-2/94V-0
- Color: Natural/Black
- Unit: mm

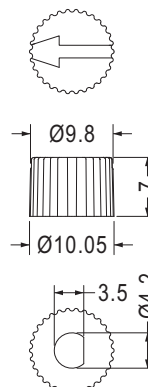

Part No.	Package
EMAC-463	1000

7



- USB座護蓋
USB Housing
- 防塵蓋
Connector Cover
- 光纖連接器護套
Fiber Optic
Connector Cover
- 電源插座防塵蓋
Power Connector Cover
- 螺絲固定座
Plastic Conical Anchors
- 鉚釘
Snap Rivet
- 風扇鉚釘
Fan Mount Rivet
- 散熱片扣件
Heat Sink Rivet
- 門扣
Door Lock



USB座護蓋 USB PORT COVER

用途：用於USB接頭防塵與保護。

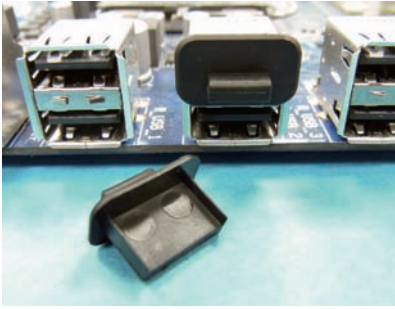

- Material: ABS (UL)
- Flame Class: 94HB
- Color: Black
- Unit: mm

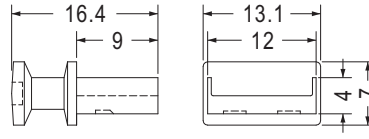

Part No.	Package
USBC-2	1000

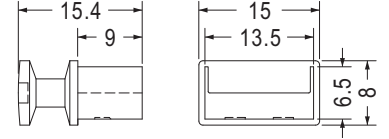

Part No.	Package
USBC-6	1000

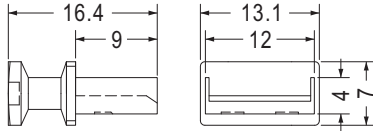

Part No.	Package
USBC-24	1000

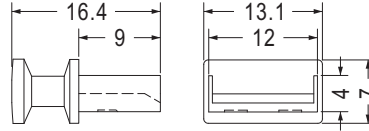

Part No.	Package
USBC-37	1000

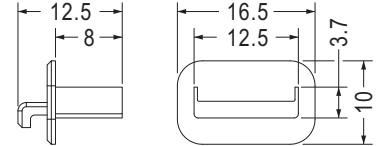

- Material: PP
- Color: Black

Part No.	Package
USBC-14	1000

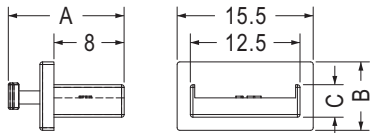

- Material: PP (UL)
- Flame Class: 94HB
- Color: Natural/Black

Part No.	A	B	C	Package
USBC-33	13.2	7.8	3.7	1000
USBC-33-1	14.5	8.0	3.8	

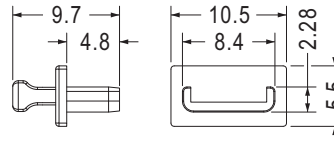

- Material: Nylon 66 (UL)
- Flame Class: 94V-2/94V-0

Part No.	Package
USBC-43	1000

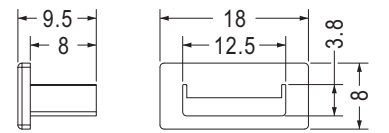

- Material: TPE (UL)
- Flame Class: 94V-0

Part No.	Package
USBC-33-2	1000

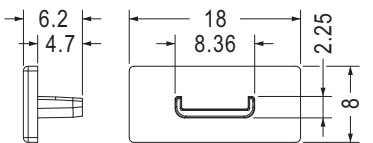

- Material: TPE (UL)
- Flame Class: 94V-0

Part No.	Package
USBC-43-1	1000

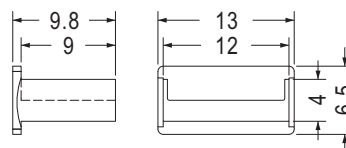

- Material: PP
- Color: Black/Computer

Part No.	Package
USBC-4	1000

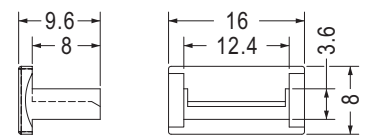

Part No.	Package
USBC-11	1000



- Material: Nylon 66 (UL)
- Flame Class: 94V-2/94V-0
- Color: Natural/Black
- Unit: mm

用途：用於重要的USB接頭之堵塞，避免重要資料洩漏。拔卸困難，兼具防塵與保護。

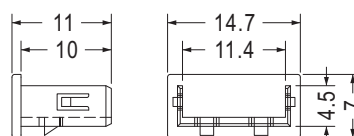

不可重複使用 Not Reusable

Part No.	Package
USBC-8	1000

USB座護蓋 USB PORT COVER

用途：用於USB TYPE A DIP接頭，拔卸困難，兼具防塵與保護。



- Material: Nylon 66 (UL)
- Flame Class: 94V-2/94V-0
- Color: Natural/Black
- Unit: mm

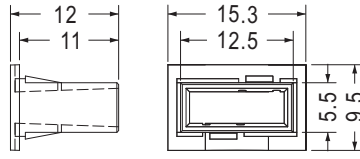

Part No.	Package
USBC-7	1000

不可重複使用 Not Reusable



- Material: PP
- Color: Black
- Unit: mm

用途：用於USB接頭防塵與保護。

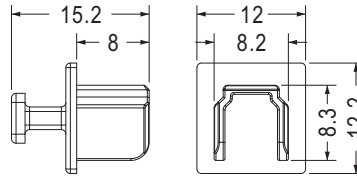

Part No.	Package
USBC-34	1000

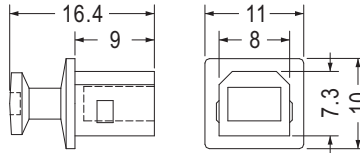

- Material: ABS (UL)
- Flame Class: 94HB

Part No.	Package
USBC-1	1000

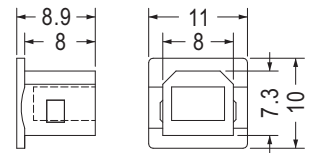

- Color: Black/Computer

Part No.	Package
USBC-3	1000



- Material: Nylon 66 (UL)
- Flame Class: 94V-2/94V-0
- Color: Black
- Unit: mm

用途：用於POWER USB接頭防塵與保護。

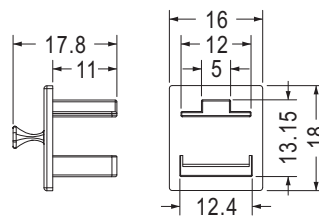

Part No.	Package
USBC-42	1000

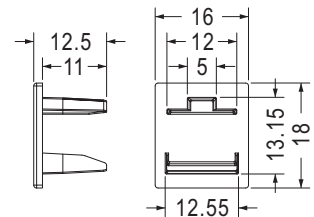

- Material: TPE (UL)
- Flame Class: 94V-0

Part No.	Package
USBC-42-1	1000

MICRO USB防塵蓋 MICRO USB PORT COVER

用途：用於MICRO USB接頭防塵與保護。



- Material: TPE
- Color: Black
- Unit: mm

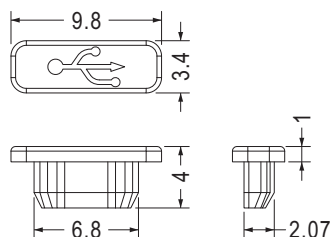

Part No.	Package
USBC-15	1000

MICRO USB防塵蓋 MICRO USB PORT COVER

用途：用於MICRO USB接頭防塵與保護。



- Material: PE
- Color: Black
- Unit: mm

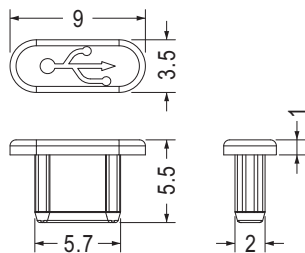

Part No.	Package
USBC-31	1000

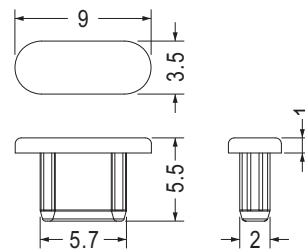

- Material: TPE (UL)
- Flame Class: 94V-0

Part No.	Package
USBC-31-1	1000

MINI USB座護蓋 MINI USB PORT COVER

用途：用於MINI USB接頭防塵與保護。



- Material: PP (UL)
- Flame Class: 94HB
- Color: Black
- Unit: mm

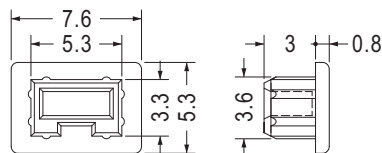

Part No.	Package
USBC-9	1000



- Material: TPE
- Color: Black
- Unit: mm

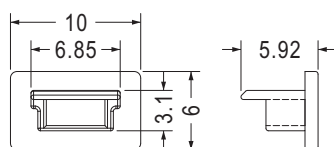

Part No.	Package
USBC-10	1000

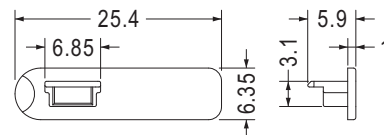

Part No.	Package
USBC-13	1000

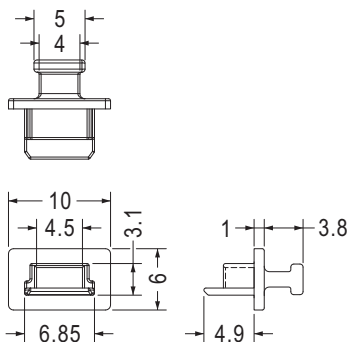

Part No.	Package
USBC-25	1000

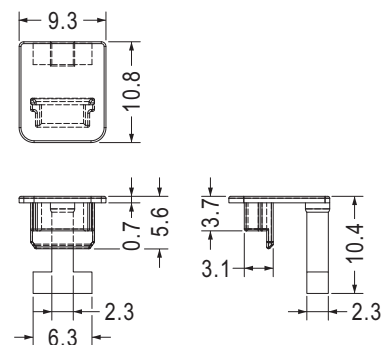

Part No.	Package
USBC-16	1000

MINI SAS HD防塵蓋 MINI SAS HD COVER

用途：用於MINI SAS HD接頭防塵與保護。

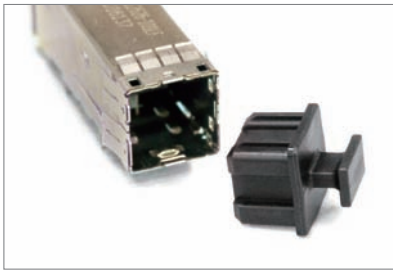

- Material: PE
- Color: Black
- Unit: mm

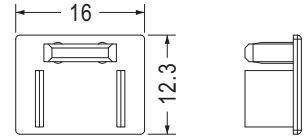
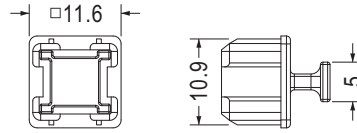
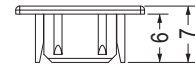
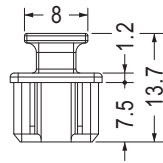

- Material: TPE

Part No.	Package
KPS-32	1000

Part No.	Package
KPS-39	1000

USB座護蓋 USB PORT COVER

用途：用於USB接頭防塵與保護。



- Material: TPE
- Color: Black
- Unit: mm

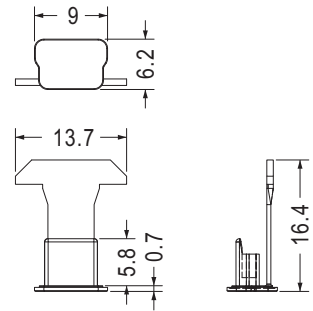
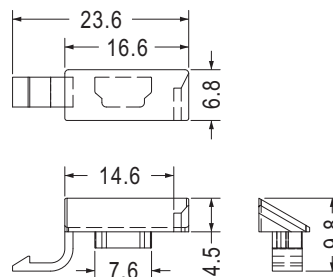

- Material: TPU

Part No.	Package
USBC-17	1000

Part No.	Package
USBC-30	1000

防塵蓋 CONNECTOR COVER

用途：用於汽車點菸器防塵與保護用。



- Material: TPE
- Color: Black
- Unit: mm

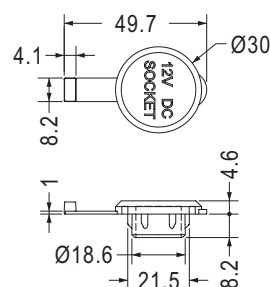

Part No.	Package
DCVER-1	500



- Material: TPE
- Color: Black
- Unit: mm

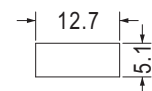
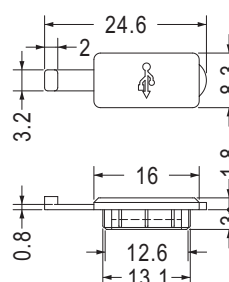

MOUNTING HOLE

Part No.	Package
COVER-1	500

防塵蓋 CONNECTOR COVER

用途：用於USB接頭防塵與保護。



- Material: Silicon Rubber (UL)
- Flame Class: 94V-0
- Color: Black
- Unit: mm

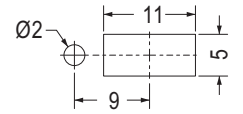
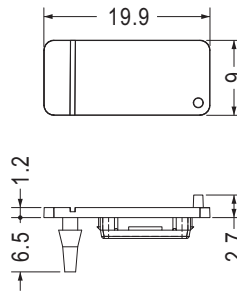

MOUNTING HOLE
THICKNESS 1.0

Part No.	Package
CJCV-3	1000

- Material: Silicon Rubber
- Color: Black
- Unit: mm

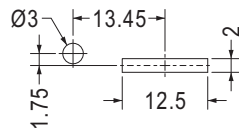
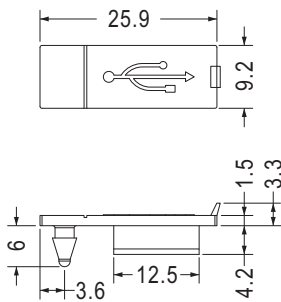

MOUNTING HOLE
THICKNESS 1.5

Part No.	Package
CJCV-7	1000

- Material: TPU
- Color: Black/White
- Unit: mm

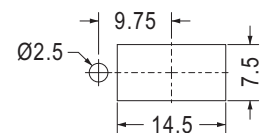
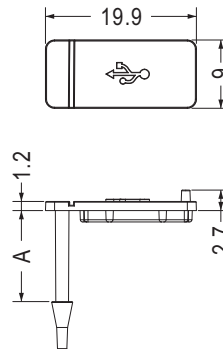

MOUNTING HOLE

Part No.	A	Package
CJCV-1	1.8	500
CJCV-2	12.0	

BBU防塵蓋 CONNECTOR COVER

用途：用於BBU的防塵與保護用。



- Material: TPU
- Color: Black
- Unit: mm

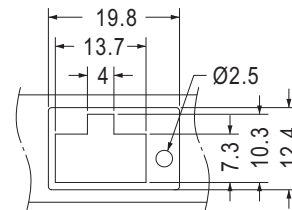
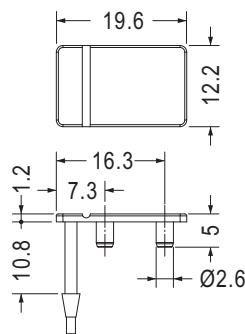

MOUNTING HOLE

Part No.	Package
CJCV-4	1000

7



- Material: TPE (UL)
- Flame Class: 94V-0
- Color: Black
- Unit: mm

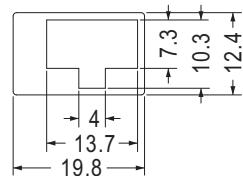
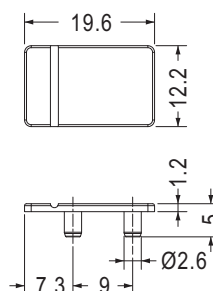

MOUNTING HOLE
(RECOMMEND FOR REFERENCE ONLY)

Part No.	Package
★CJCV-12	1000

連接器蓋 CONNECTOR COVER

用途：用於連接器防塵與保護。



- Material: TPU
- Color: Black/White
- Unit: mm

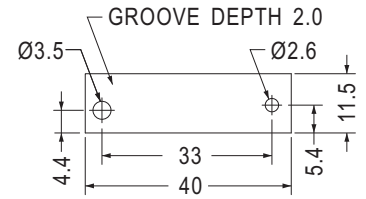
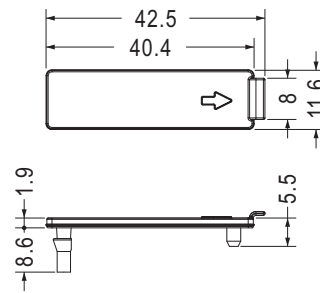

MOUNTING HOLE

Part No.	Package
EMC-1	500

SIM卡蓋 SIM CARD CAP

用途：用於SIM卡防塵與保護用。



- Material: TPU
- Color: Black/White
- Unit: mm

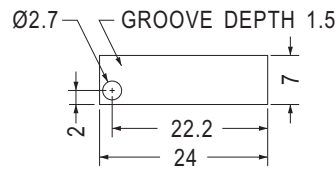
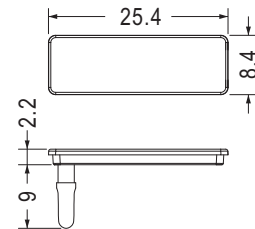
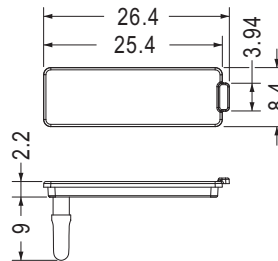

MOUNTING HOLE

Part No.	Package
EM-303	500

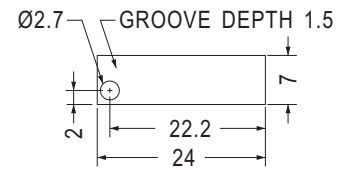

MOUNTING HOLE

Part No.	Package
EM-303-1	500

SD防塵蓋 SD CONNECTOR COVER

用途：用於SD卡防塵與保護用。



- Material: TPE
- Color: Black
- Unit: mm

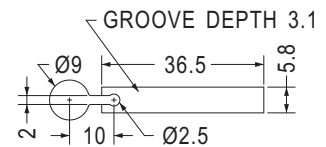
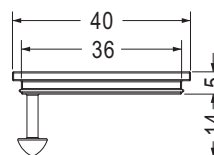

MOUNTING HOLE

Part No.	Package
CJCV-6	1000

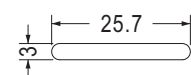
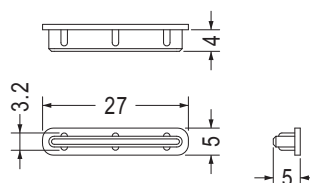

MOUNTING HOLE

Part No.	Package
CJCV-11	1000

USB TYPE-C防塵蓋 USB 3.0 TYPE-C COVER

用途：用於USB 3.0 TYPE-C接頭之防塵與保護。



- Material: PE
- Color: Black
- Unit: mm

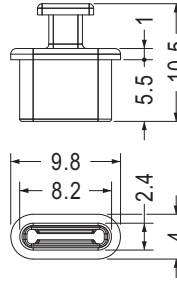

Part No.	Package
USB3C-1	1000

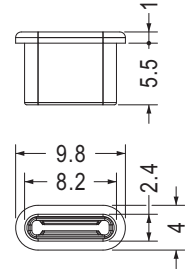

Part No.	Package
USB3C-2	1000

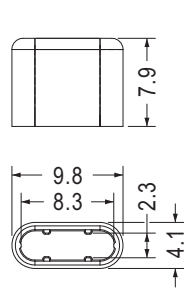

Part No.	Package
USB3C-3	1000

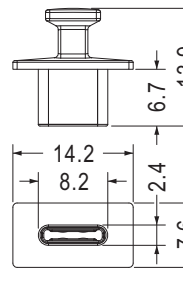

Part No.	Package
USB3C-4	1000

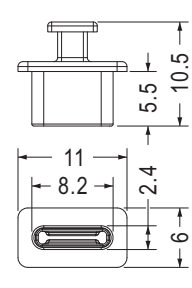

Part No.	Package
USB3C-7	1000

USB座護蓋 USB COVER

用途：用於USB 3.0接頭防塵與保護。



- Material: TPE
- Color: Black
- Unit: mm

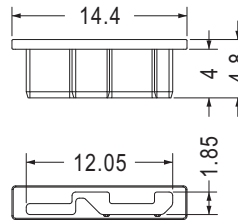

Part No.	Package
USBC-21	1000

防塵蓋 CONNECTOR COVER

用途：用於KVM連接器之防塵與保護。

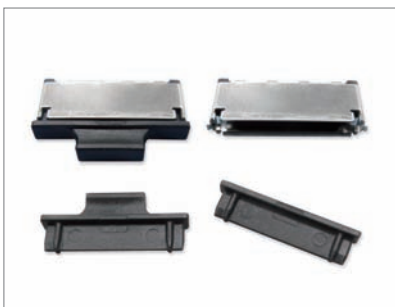

- Material: PE
- Color: Black
- Unit: mm

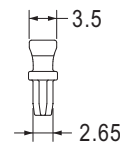
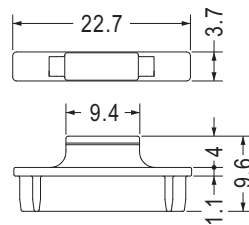

Part No.	Package
KVM-1	1000
KVM-2	

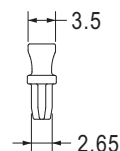
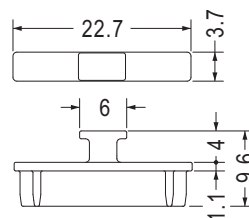

Part No.	Package
KVM-3	1000

CF防塵蓋 CONNECTOR COVER

用途：用於CF連接器之防塵與保護。

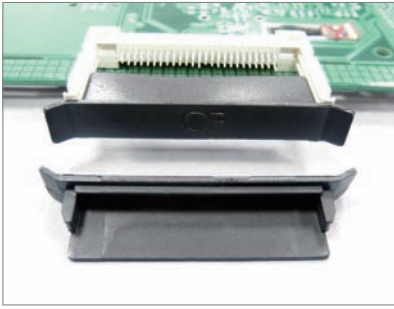

- Material: TPU
- Color: Black
- Unit: mm

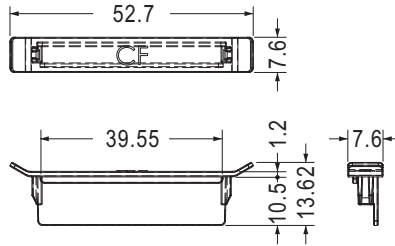

Part No.	Package
CFC-1	500

USB座護蓋 USB HOUSING

用途：用於USB防塵與保護。

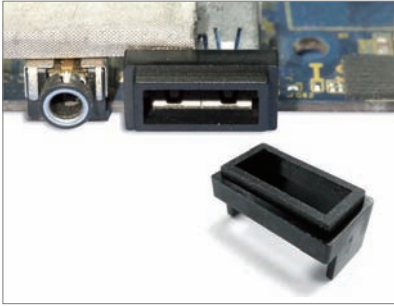

- Material: Nylon 66 (UL)
- Flame Class: 94V-2/94V-0
- Color: Natural/Black
- Unit: mm

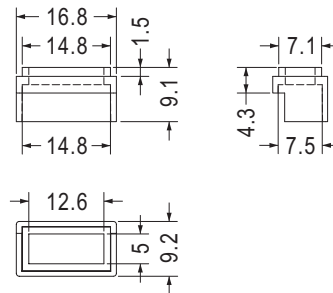

Part No.	Package
USBH-1	1000

IPHONE防塵蓋 IPHONE COVER

用途：用於iPhone連接器的防塵與保護用。



- Material: TPU
- Color: Black
- Unit: mm

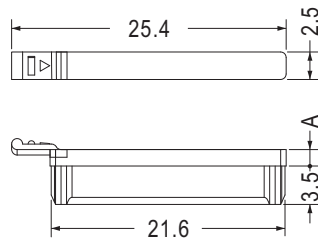

Part No.	A	For	Package
IPOD-1	1.5	iPhone 3	1000
IPOD-2	1.0	iPhone 4	

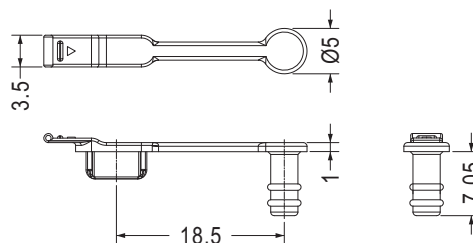

Part No.	Package
IPOD-3	1000

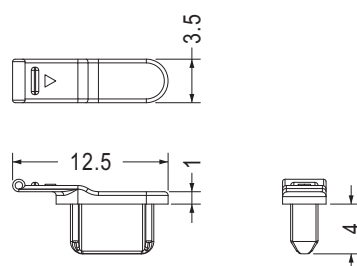

Part No.	Package
IPOD-4	1000

防塵蓋 CONNECTOR COVER



- Material: Nylon 66 (UL)
- Flame Class: 94V-2/94V-0
- Color: Black
- Unit: mm

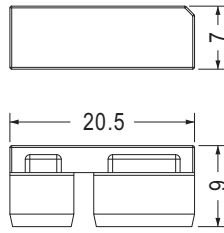

用途：使用於PCI-E X1連接器的防塵與保護用。

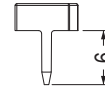

Part No.	Package
PCIEX-1	1000

IPHONE防塵蓋 IPHONE CONNECTOR COVER



- Material: PE
- Color: Natural
- Unit: mm

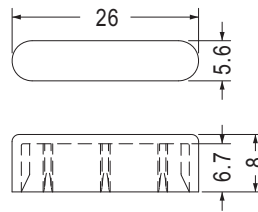

用途：用於iPhone充電器接頭之防塵與保護。

Part No.	Package
IPWC-1	1000

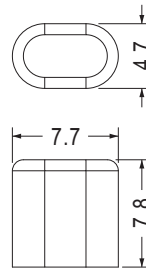

Part No.	Package
IPWC-2	2000

防塵蓋 MINI USB PLUG COVER



- Material: PE
- Color: Natural
- Unit: mm

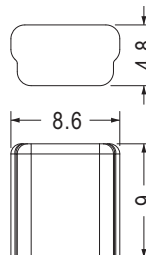

用途：用於Mini USB接頭之防塵與保護。

Part No.	Package
KPS-20	2000

MICRO USB防塵蓋 MICRO USB PLUG COVER



- Material: PE
- Color: Natural
- Unit: mm

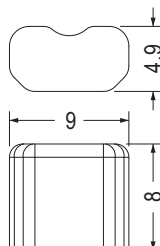

用途：用於Micro USB接頭防塵與保護。

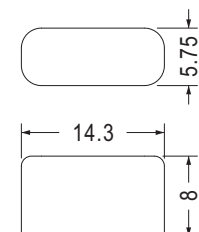

Part No.	Package
KPS-21	2000

Part No.	Package
KPS-24	1000

防塵蓋 CONNECTOR COVER

用途：用於RJ-11連接器之防塵與保護。



- Material: PE
- Color: Natural
- Unit: mm

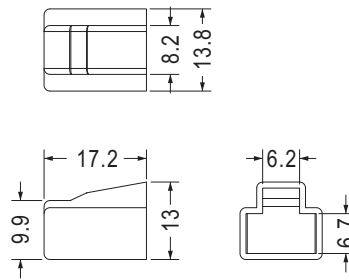

Part No.	Package
PJCV-1	1000

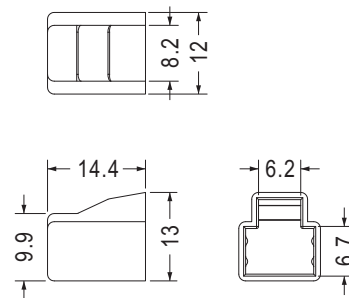

Part No.	Package
PJCV-11	1000



- Material: PE
- Color: Natural
- Unit: mm

用途：用於USB接頭防塵與保護。

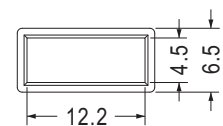
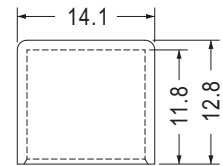
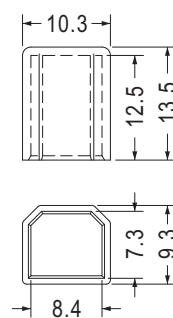

Part No.	Package
KPS-5	1000

Part No.	Package
KPS-6	1000



- Material: PE
- Color: Natural
- Unit: mm

用途：用於連接器防塵與保護。

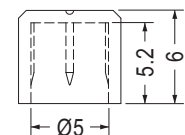
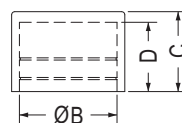
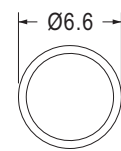
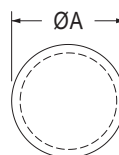

Part No.	A	B	C	D	Package
KPS-1	15.8	13.4	11.2	10.0	500
KPS-2	10.7	9.0	9.6	8.6	1000
KPS-3	10.3	8.4	8.0	7.0	

Part No.	Package
KPS-16	1000

連接器蓋 CONNECTOR COVER

用途：用於天線連接器之防塵與保護。



- Material: Silicon Rubber
- Color: Black
- Unit: mm

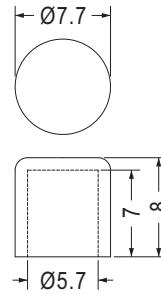

Part No.	Package
TF-589	1000

防塵蓋 CONNECTOR COVER

用途：用於連接器防塵與保護。



- Material: PE
- Color: Natural/White/Black
- Unit: mm

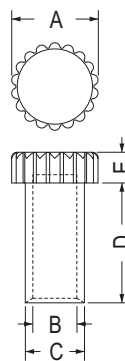

Part No.	A	B	C	D	E	Package
KPSA-1	5.7	2.85	3.85	7.8	2.0	1000
KPSA-3	4.5	2.3	3.3	3.5	3.2	

光纖連接器護蓋 OPTICAL PORT COVER

用途：用於光纖連接器之防塵與保護。



- Material: PE
- Color: Natural
- Unit: mm

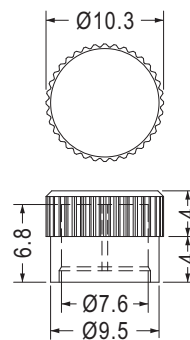

Part No.	Package
KPS-4	1000

端子蓋 CONNECTOR COVER

用途：用於連接器RCA端子之防塵與保護用。



- Material: PE
- Color: Natural
- Unit: mm

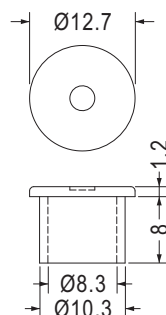

Part No.	Package
KPS-9	1000

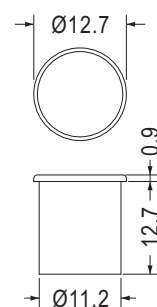

Part No.	Package
CRCAM-1	1000

端子蓋 CONNECTOR COVER

用途：用於F端子之防塵與保護用。



- Material: PE
- Color: Natural/Black
- Unit: mm

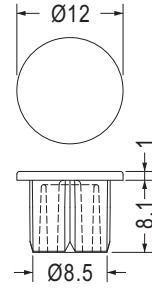
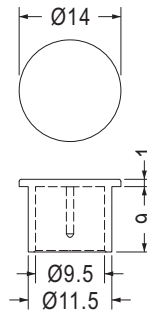

- Color: Natural

Part No.	Package
KPS-12	1000

Part No.	Package
KPS-31	1000



- Material: PE
- Color: Natural/Black
- Unit: mm

用途：用於天線端子之防塵與保護。

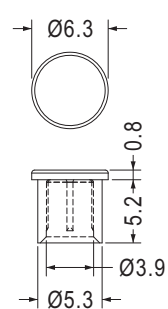
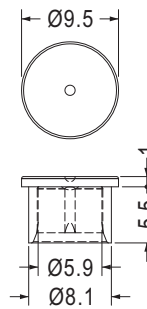

Part No.	Package
KPS-29	1000

Part No.	Package
★KPS-46	1000

S端子蓋 S-VIDEO PLUG COVER

用途：S端子之防塵與保護。



- Material: PP
- Color: Natural/Black
- Unit: mm

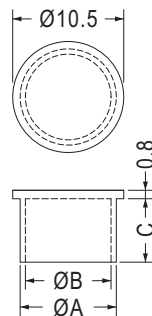

Part No.	A	B	C	Package
SVDOC-1	9.0	8.0	9.6	1000
SVDOC-3	9.1	8.1	6.0	

端子蓋 CONNECTOR COVER

用途：用於端子之防塵與保護。



- Material: PP
- Color: Black
- Unit: mm

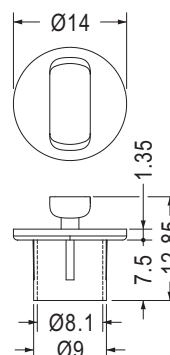

Part No.	Package
MOUC-1	1000

端子蓋 CONNECTOR COVER

用途：用於端子之防塵與保護。



- Material: PP (UL)
- Flame Class: 94HB
- Color: Black
- Unit: mm

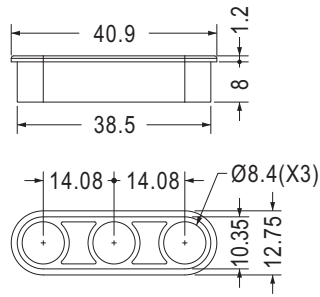

Part No.	Package
KPS-13	1000

防塵蓋 CONNECTOR COVER

用途：用於電源連接器防塵與保護。

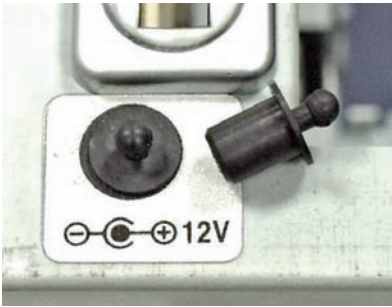

- Material: Rubber
- Color: Black
- Unit: mm

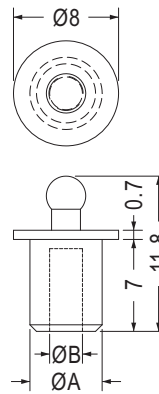

Part No.	A	B	Package
JKCV-1	5.5	2.5	1000
JKCV-4	4.0	2.0	

7



- Material: PP (UL)
- Flame Class: 94HB
- Color: Black
- Unit: mm

用途：用於連接器防塵與保護。

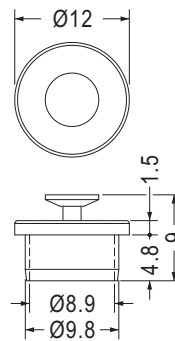

Part No.	Package
KPS-18	1000



- Material: PE
- Color: Black/Red
- Unit: mm

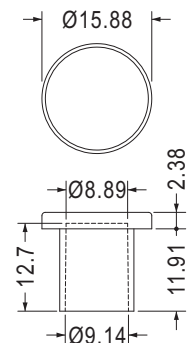
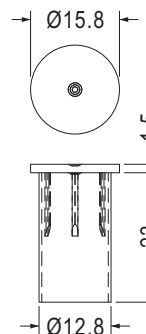

Part No.	Package
KPS-15	1000

Part No.	Package
KPS-19	1000

S端子蓋 S-VIDEO PORT COVER



- Material: PP
- Color: Natural
- Unit: mm

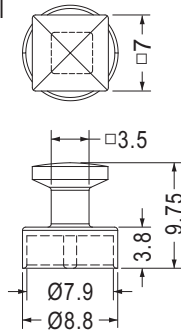

Part No.	Package
SVD0C-1S	1000

用途：S端子之防塵蓋、美觀。

- Material: PE
- Color: Natural
- Unit: mm

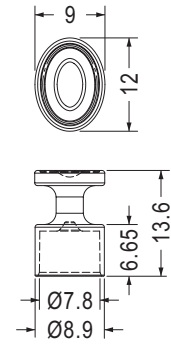

Part No.	Package
SVD0C-2	1000

平衡端子蓋 BALANCED PORT COVER



- Material: PP/PE
- Color: Computer
- Unit: mm

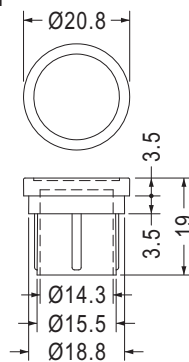

Part No.	Package
XLR-1	250

用途：平衡端子XLR座之防塵蓋、美觀。

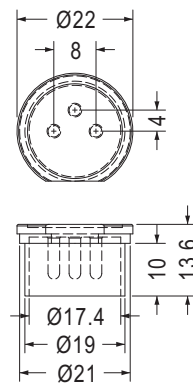

Part No.	Package
XLR-2	250

BNC絕緣座 BNC ROUND HOUSING



- Material: ABS (UL)
- Flame Class: 94HB
- Color: Natural
- Unit: mm

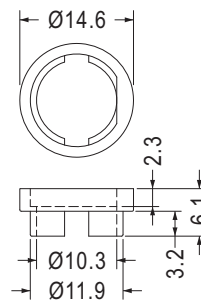

Part No.	Package
BNCH-1	1000

用途：用於BNC端子之絕緣。

BNC防塵蓋 BNC CONNECTOR COVER



- Material: PE
- Color: Black/Gray
- Unit: mm

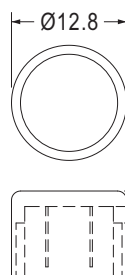

Part No.	Package
BNC-2	1000

用途：用於BNC接頭防塵保護用。

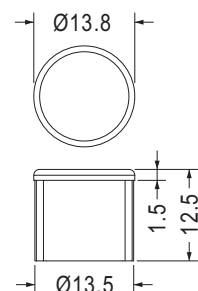

- Color: Natural

Part No.	Package
BNC-4	1000

端子蓋 CONNECTOR HOUSING

用途：RJ-45轉接RJ-11接頭。

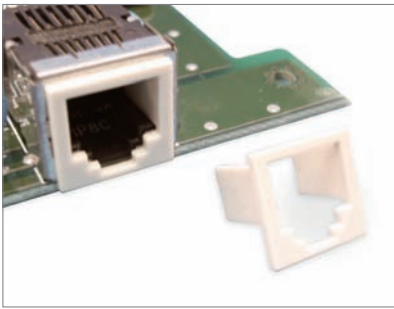

- Material: ABS (UL)
- Flame Class: 94HB
- Color: Natural/White
- Unit: mm

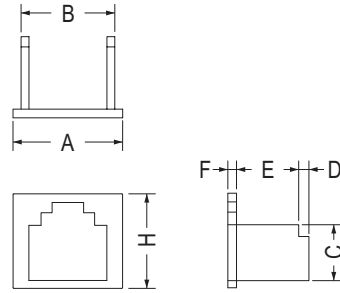

Part No.	A	B	C	D	E	F	H	Package
ASID-1	13.5	12.0	6.8	8.0	1.1	12.9	1000	
ASID-2	13.9	11.9	7.1	1.3	7.9	12.0		
ASID-3	11.8	9.6	7.0	1.5	8.0	12.5		

RJ防塵蓋 RJ COVER

用途：用於RJ-11連接器之防塵蓋。



- Material: PE
- Color: Black
- Unit: mm

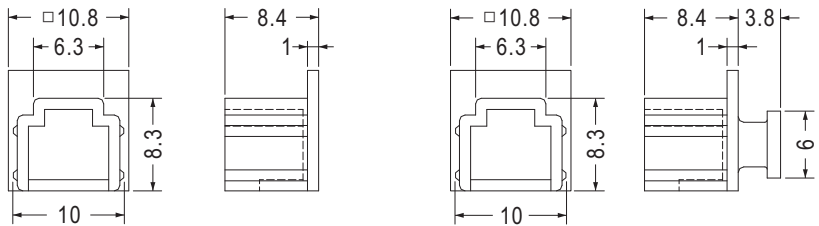

Part No.	Package
CRJ-11	1000

Part No.	Package
CRJ-11S	1000

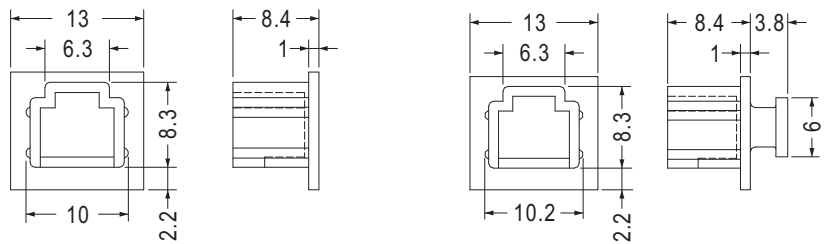

Part No.	Package
CRJ-11-2	1000

Part No.	Package
CRJ-11-2S	1000

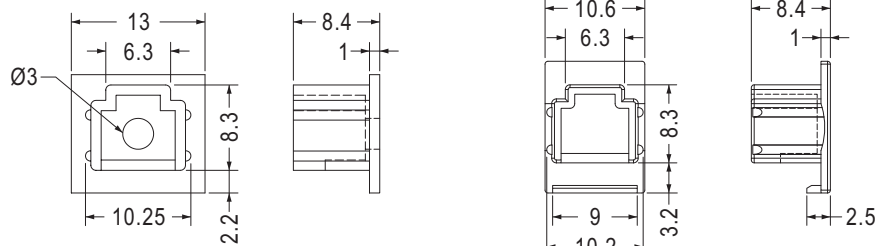
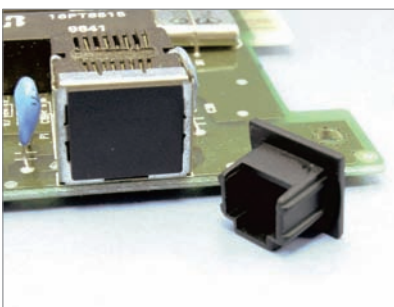

Part No.	Package
CRJ-11-3	1000

Part No.	Package
CRJ-11-6	1000

RJ防塵蓋 RJ COVER

用途：用於多餘的RJ-11連接器之堵塞，避免誤用。

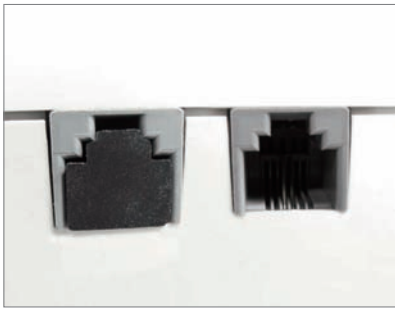

- Material: Silicon Rubber
- Color: Black
- Unit: mm

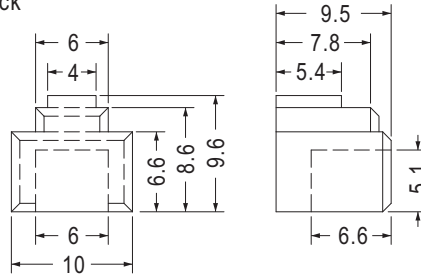

Part No.	Package
CRJ-11-4I	1000



- Material: Nylon 66 (UL)
- Flame Class: 94V-2/94V-0
- Color: Natural/Black
- Unit: mm

用途：用於RJ-11連接器之防塵蓋。

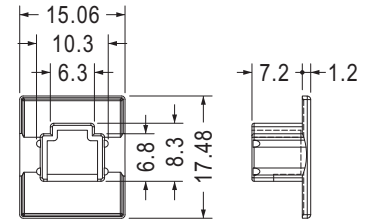
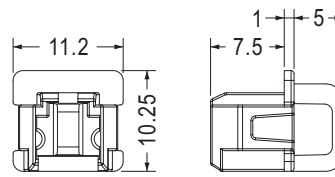

- Material: PE
- Color: White

Part No.	Package
CRJ-11-5	1000

Part No.	Package
CRJ-11-7	1000



- Material: Nylon 66 (UL)
- Flame Class: 94V-2/94V-0
- Color: Natural/Black
- Unit: mm

用途：用於網路接頭RJ-12防塵與保護。

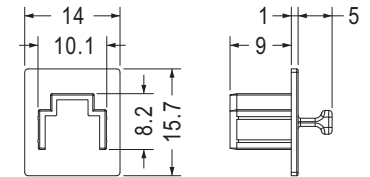
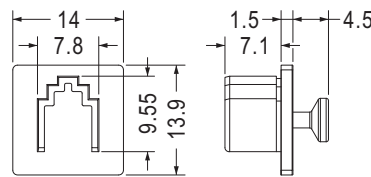

- Color: Black/Gray

Part No.	Package
CRJ-12	1000

Part No.	Package
CRJ-12-1	1000



- Material: PE
- Color: Black
- Unit: mm

用途：用於網路接頭RJ-22防塵與保護。

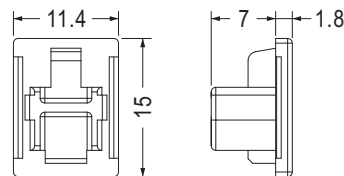

Part No.	Package
RJ-22	1000

RJ-45防塵蓋 RJ45 COVER

用途：用於多餘的RJ-45連接器之堵塞，避免誤用。

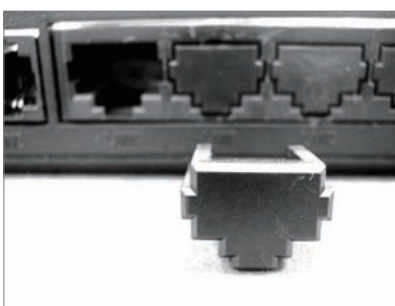

- Material: PE
- Color: Black
- Unit: mm

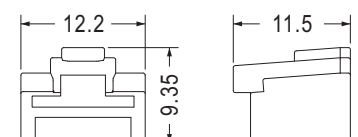
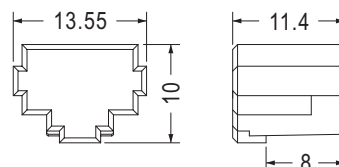

Part No.	Package
PJT-45	500

Part No.	Package
PJU-45	500

RJ-45防塵蓋 RJ45 COVER

用途：用於網路接頭RJ-45防塵與保護。

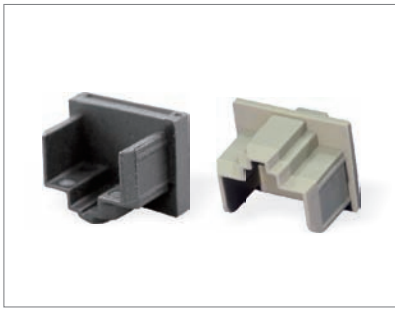

- Material: Nylon 66 (UL)
- Flame Class: 94V-2/94V-0
- Color: Natural/Black
- Unit: mm

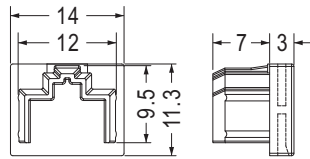

Part No.	Package
PJB-45	1000

- Material: PE
- Color: Gray
- Unit: mm

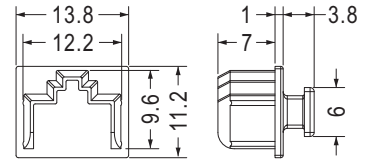

Part No.	Package
PJBA-45	1000



- Material: ABS
- Color: White
- Unit: mm

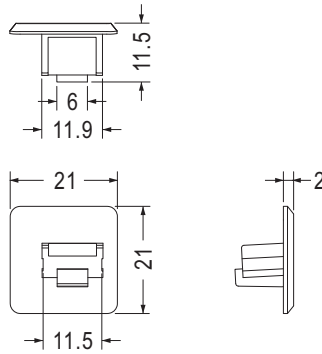

Part No.	Package
PJSA-45	1000



- Material: PE
- Color: Black
- Unit: mm

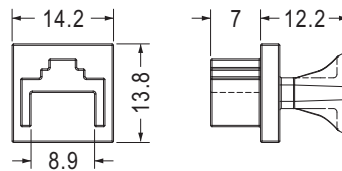

Part No.	Package
RJ-45	500



- Material: ABS (UL)
- Flame Class: 94HB
- Color: Black
- Unit: mm

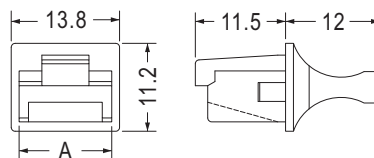

Part No.	A	Package
PJC-45	11.9	500
PJC-45L	12.0	

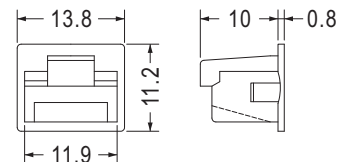

Part No.	Package
PJS-45	500

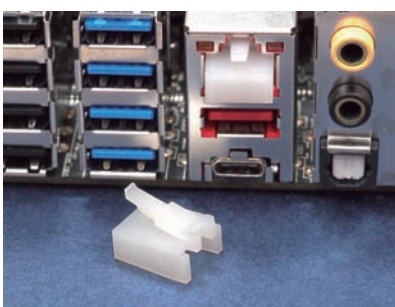

- Material: Nylon 66 (UL)
- Flame Class: 94V-2/94V-0
- Color: Natural/Black
- Unit: mm

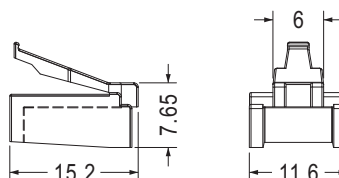

Part No.	Package
PJRA-45	500

RJ-45防塵蓋 RJ45 COVER

用途：用於網路接頭RJ-45防塵與保護。

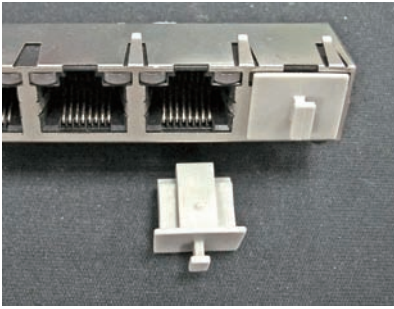

- Material: PE
- Color: Black
- Unit: mm

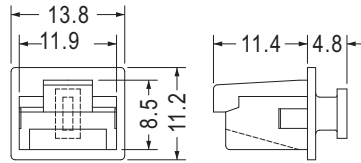

- Color: Black/Gray

Part No.	Package
PJR-45	500

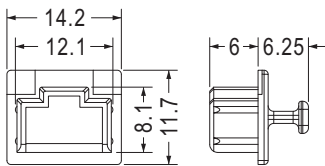

Part No.	Package
PJD-45	1000

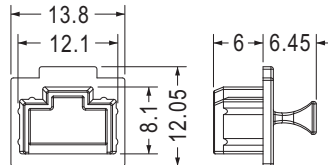

- Material: Nylon 66 (UL)
- Flame Class: 94V-2/94V-0

Part No.	Package
PJD-45-1	1000

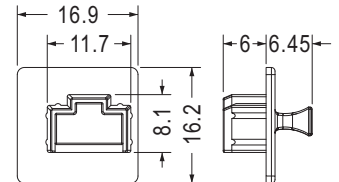

- Material: Nylon 66 (UL)
- Flame Class: 94V-2/94V-0

Part No.	Package
PJD-45-2	1000

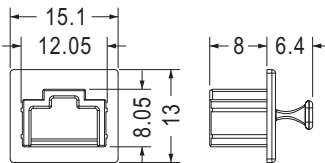

- Material: Nylon 66 (UL)
- Flame Class: 94V-2/94V-0
- Color: Black/Gray

Part No.	Package
PJD-45-4	1000

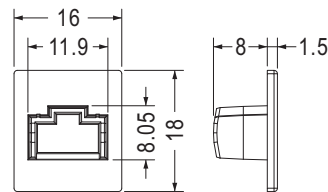

- Material: TPE (UL)
- Flame Class: 94V-0
- Color: Black/Gray

Part No.	Package
PJD-45-5	1000

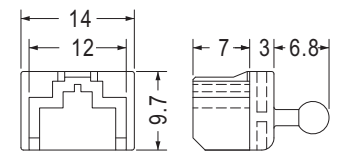

- Material: Nylon 66 (UL)
- Flame Class: 94V-2/94V-0

Part No.	Package
PJV-45	1000

防塵蓋 CONNECTOR COVER

用途：用於CD ROM音源線之防塵與保護。



- Material: PE
- Color: Black
- Unit: mm

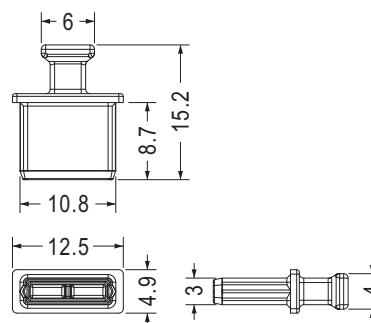

Part No.	Package
CDMCV-1	1000

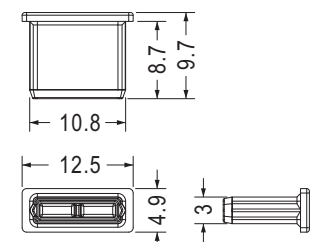

Part No.	Package
CDMCV-2	1000

光纖連接器護套 FIBER OPTIC CONNECTOR COVER

用途：用於光纖接頭PLT130T防塵與保護。



- Material: ABS (UL)
- Flame Class: 94HB
- Color: Black
- Unit: mm

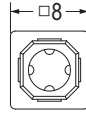
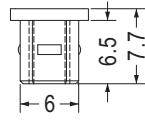

Part No.	Package
OPC-2	1000

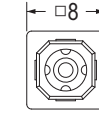
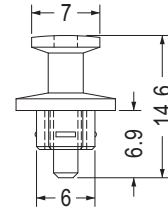

Part No.	Package
OPC-1	1000

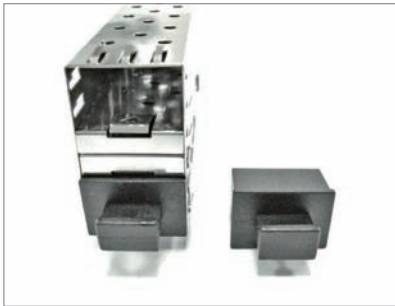

- Material: PE
- Color: Black
- Unit: mm

用途：用於光纖接頭防塵與保護。

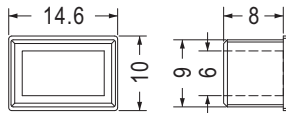
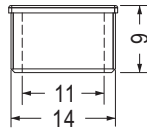

Part No.	Package
SFPC-3	1000

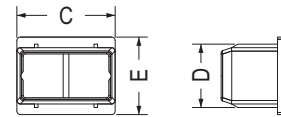
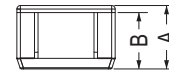

Part No.	A	B	C	D	E	Package
SFPC-13	9.0	8.0	14.0	9.25	11.0	1000
SFPC-17	11.0	10.0	18.5	8.9	10.0	1000

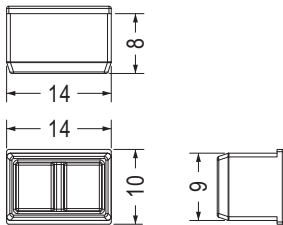

Part No.	Package
SFPC-7	1000

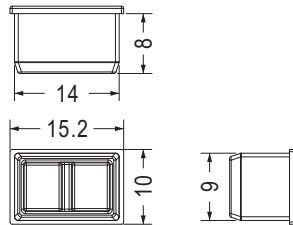

Part No.	Package
SFPC-8	1000

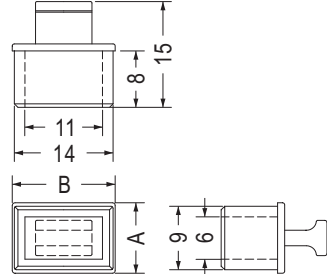

Part No.	A	B	Package
SFPC-1	10.0	14.6	1000
SFPC-10	9.8	14.4	1000

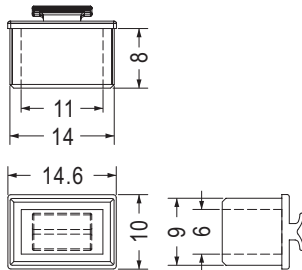

Part No.	Package
SFPC-2	1000

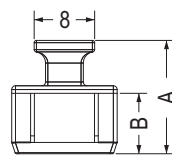

【 SFPC-11, SFPC-12, SFPC-14 】

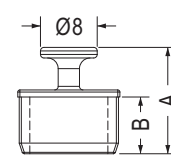

【 SFPC-18 】

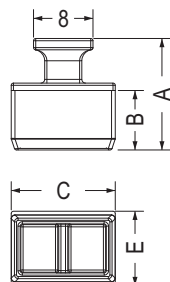

Part No.	A	B	C	D	E	Package
SFPC-4	15.0	8.0	14.0	9.0	10.0	1000
SFPC-5	17.0	10.0	18.5	8.7	10.0	
SFPC-11	15.0	8.0	14.0	9.0	10.0	
SFPC-12	17.0	10.0	18.5	8.9	10.0	
SFPC-14	15.0	8.0	14.0	9.25	11.0	
SFPC-18	15.0	8.0	14.4	9.0	9.8	

光纖連接器護套 FIBER OPTIC CONNECTOR COVER

用途：用於光纖接頭防塵與保護。



- Material: TPE
- Color: Black
- Unit: mm

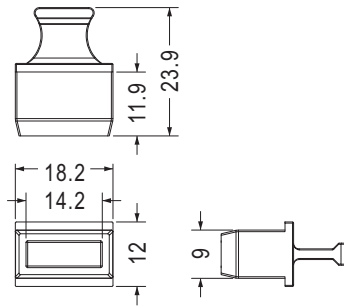

Part No.	Package
SFPC-19	1000

- Material: Nylon 66 (UL)
- Flame Class: 94V-2

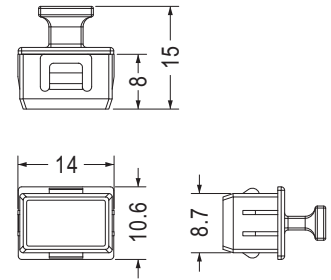

Part No.	Package
SFPC-22	1000



- Material: TPE
- Color: Black
- Unit: mm

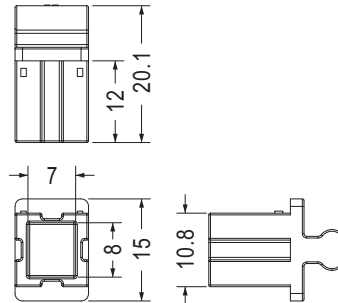

Part No.	Package
SFPC-21	500

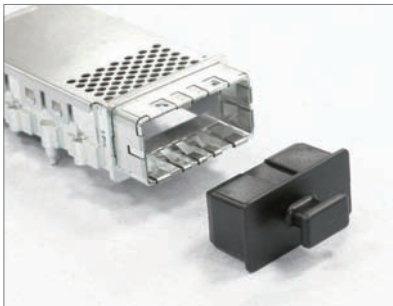

- Material: PE
- Color: Black
- Unit: mm

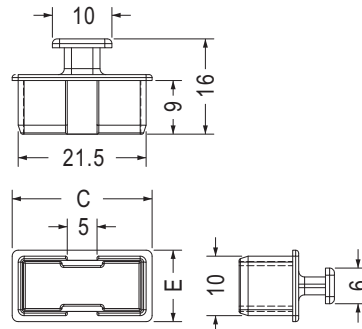

Part No.	C	E	Package
CXP-1	23.5	12.0	1000
CXP-2	22.0	11.0	

- Material: Silicon Rubber (UL)
- Flame Class: 94V-0

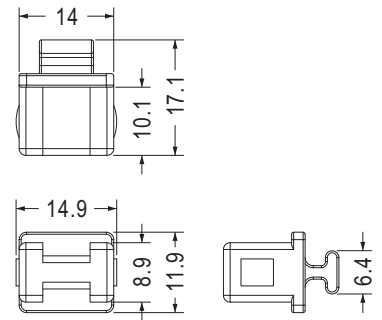

Part No.	Package
SFPC-9	1000

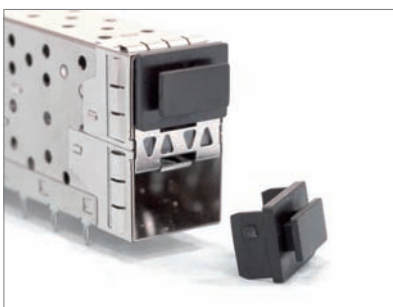

- Material: ABS (UL)
- Flame Class: 94V-0
- Color: Black
- Unit: mm

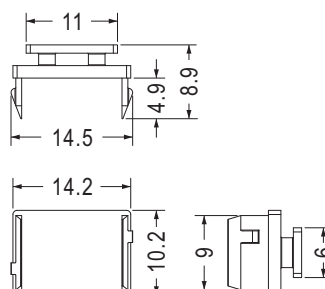

Part No.	Package
SFPC-15	1000

光纖防塵蓋 CONNECTOR COVER

用途：用於光纖座之防塵與保護。



- Material: PE
- Color: Natural
- Unit: mm

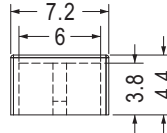
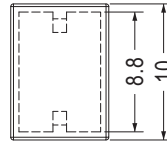

Part No.	Package
COVER-11	1000

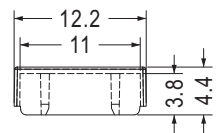
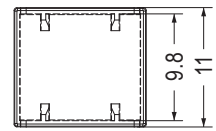

Part No.	Package
COVER-12	1000



- Material: TPE
- Color: Black
- Unit: mm

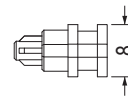
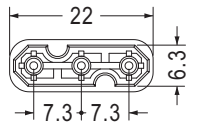
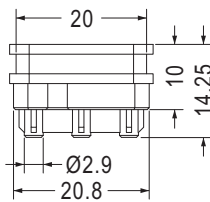

Part No.	Package
COVER-3	1000

SATA防塵蓋 SATA COVER

用途：用於多餘不使用的SATA端子之遮蔽，避免誤用。

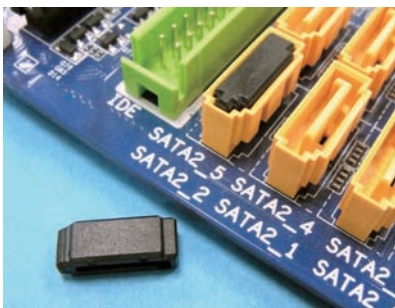

- Material: PE
- Color: Black
- Unit: mm

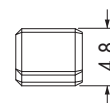
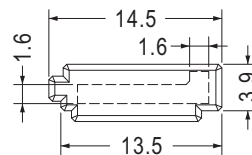
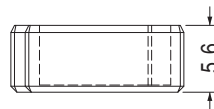

Part No.	Package
CSATA-1	1000



- Material: PE
- Color: Black
- Unit: mm

用途：用於SATA端子之防塵。

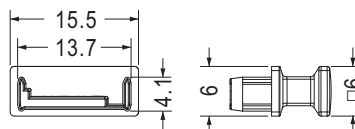
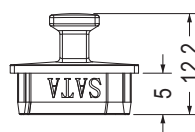

Part No.	Package
SATAC-1	1000

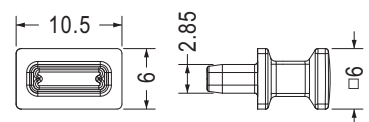
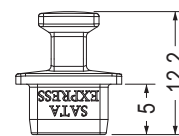

Part No.	Package
SATAC-2	1000

SATA防塵蓋 SATA COVER

用途：用於SATA端子之防塵。

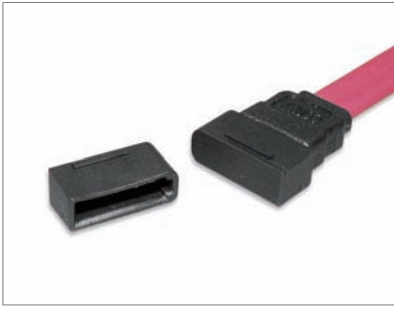

- Material: PE
- Color: Black
- Unit: mm

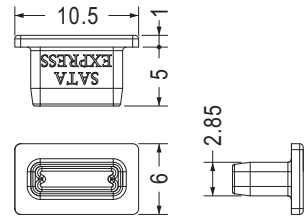
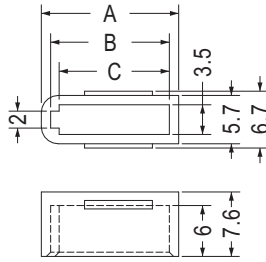

Part No.	A	B	C	Package
SATAC-7	16.2	14.0	13.0	1000
SATAC-15	26.4	24.2	23.2	

Part No.	Package
SATAC-3	1000

SATA防塵蓋 SATA CABLE PLUG COVER

用途：用於SATA端子之防塵蓋。



- Material: PC+ABS (UL)
- Flame Class: 94V-2/94V-0
- Color: Black
- Unit: mm

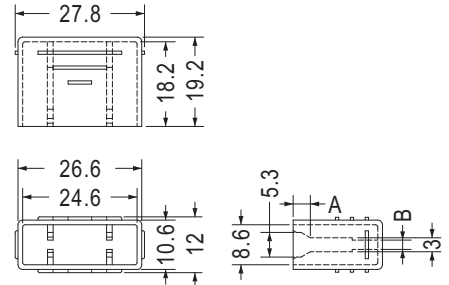
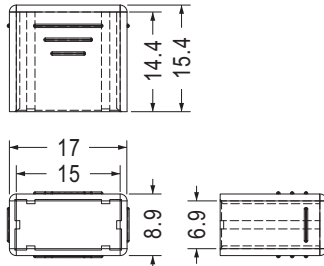

Part No.	Package
CVSATA-15	1000
CVSATA-7	

Part No.	A	B	Package
CVSATA-15	3.7	2.0	500
CVSATA-15S	9.7		



- Material: PC+ABS (UL)
- Flame Class: 94V-0
- Color: Black
- Unit: mm

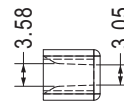
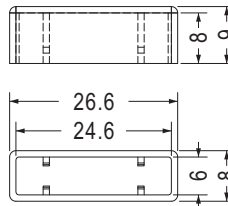

Part No.	Package
CVSATAA-15	500

ESATA護蓋 ESATA COVER

用途：於ESATA上保護插頭，防氧化。



- Material: ABS (UL)
- Flame Class: 94HB
- Color: Black
- Unit: mm

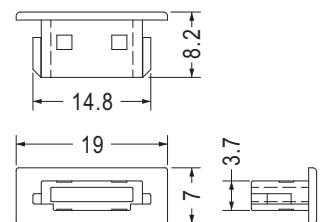
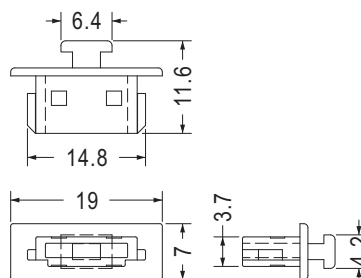

Part No.	Package
ESATA-7	1000

Part No.	Package
ESATA-7-1	1000

防塵蓋 CONNECTOR COVER

用途：用於數位DP端子之防塵蓋、美觀。

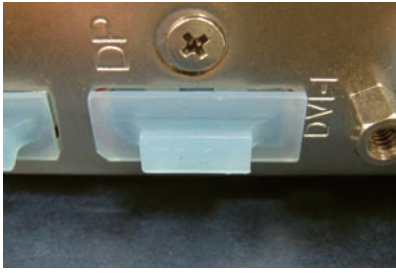

- Material: PE
- Color: Natural/Transparent Blue
- Unit: mm

- Material: PE/Nylon 66 (UL)
- Flame Class: 94V-2/94V-0
- Color: Natural/Black

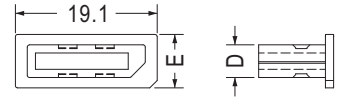
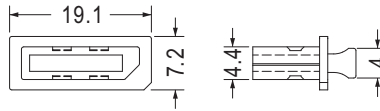
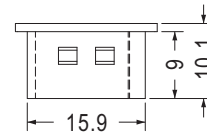
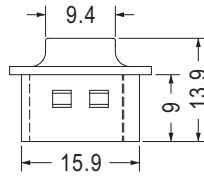

Part No.	Package
DPC-1	1000

Part No.	D	E	Package
DPC-3	4.4	7.2	1000
DPC-3L	4.5	7.4	



- Material: PE
- Color: Black
- Unit: mm

用途：使多餘或無功能的Display Port (DP端子)遮蔽，避免使用者誤插。

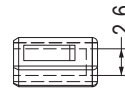
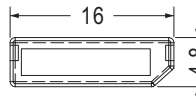
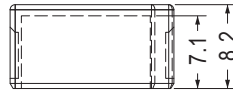

Part No.	Package
DPC-2	1000



- Material: PE
- Color: Natural
- Unit: mm

用途：用於Display Port(DP端子)之防塵與保護。

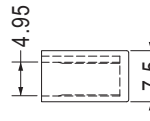
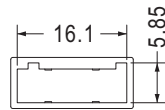
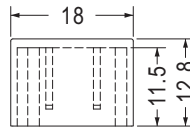

Part No.	Package
KPS-37	1000



- Material: PE
- Color: Natural/Transparent Blue
- Unit: mm

用途：用於Mini DP數位端子之防塵蓋、美觀。

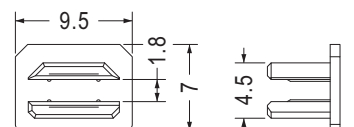
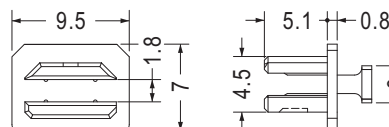
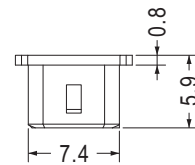
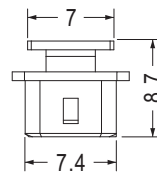

Part No.	Package
MIDP-2	2000

• Color: Black

Part No.	Package
★MIDP-4	2000

防塵蓋 CONNECTOR COVER

用途：用於Mini數位端子之防塵蓋、美觀。



- Material: PE
- Color: Natural/Transparent Blue
- Unit: mm

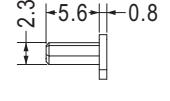
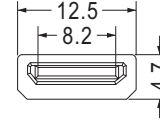
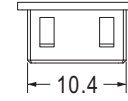
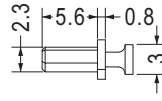
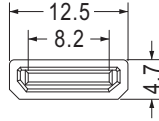
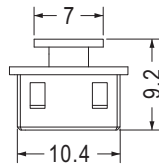

Part No.	Package
MIHDMI-2	2000

Part No.	Package
MIHDMI-3	2000

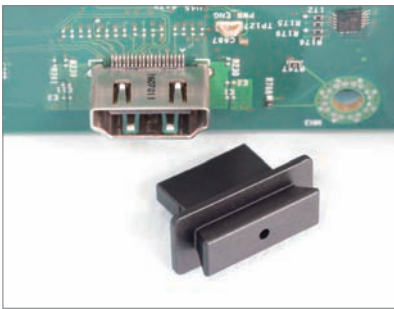

- Material: PE
- Color: Black
- Unit: mm

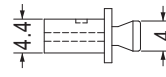
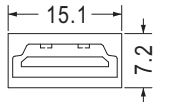
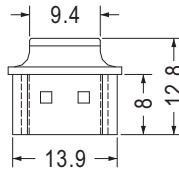

Part No.	Package
HDMIC-1	1000

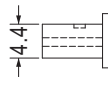
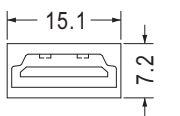
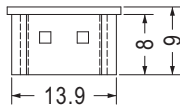

Part No.	Package
HDMIC-2	1000

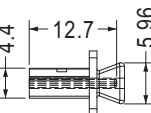
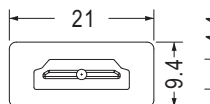
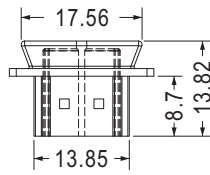

Part No.	Package
HDMIC-10	1000

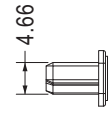
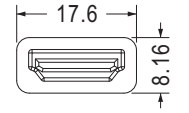
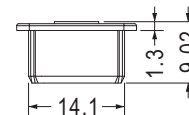

• Material: Rubber

Part No.	Package
HDMIC-11	1000

MICRO HDMI防塵蓋 CONNECTOR COVER

用途：用於Micro HDMI端子座之防塵蓋、美觀。



- Material: TPE
- Color: Black
- Unit: mm

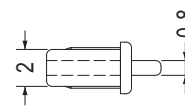
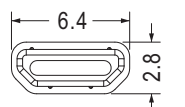
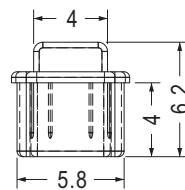

Part No.	Package
HDMIC-8	1000

HDMI防塵蓋 HDMI PORT COVER



- Material: Nylon 66 (UL)
- Flame Class: 94V-2/94V-0
- Color: Natural/Black
- Unit: mm

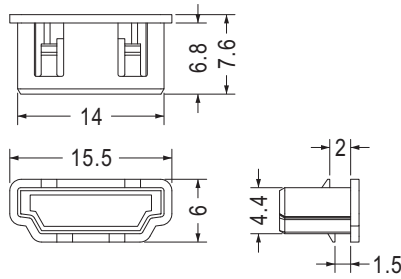

Part No.	Package
HDMIC-3	1000

用途：用於HDMI端子座之防塵、美觀，具有封孔功能，避免錯誤使用拆拔。

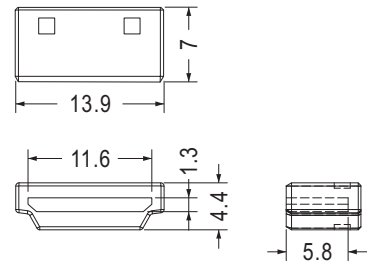

- Material: PE

Part No.	Package
HDMIC-4	1000

HDMI端子蓋 HDMI PLUG COVER



- Material: PE
- Color: Natural
- Unit: mm

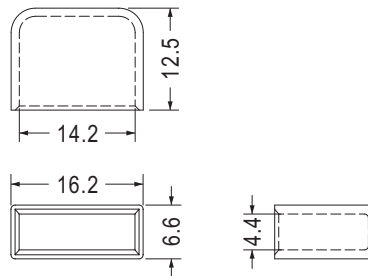

Part No.	Package
HDMIT-1	1000

用途：用於HDMI端子上保護插頭，防氧化。

D.TYPE防塵蓋 D.TYPE CONNECTOR COVER



- Material: PP (UL)
- Flame Class: 94HB
- Color: Natural/Black/Gray
- Unit: mm

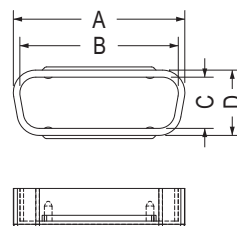

Part No.	A	B	C	D	Package
DTC-9F	18.5	16.5	7.8	10.2	1000
DTC-15F	26.8	24.8	7.8	10.2	500
DTC-25F	40.6	38.6	7.8	10.2	
DTC-9M	20.0	18.0	9.4	11.8	1000
DTC-15M	28.2	26.4	9.4	11.8	500
DTC-25M	42.0	40.0	9.4	11.8	

用途：用於D.Type連接器之防鏽、防塵與保護。

7



- Material: PP (UL)
- Flame Class: 94HB
- Color: Black/Transparent
- Unit: mm

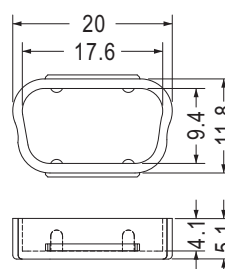

Part No.	Package
DTC-9MS	1000

D.TYPE防塵蓋 D.TYPE CONNECTOR COVER

用途：用於D.TYPE連接器之防鏽、防塵與保護。



- Material: PE
- Color: Natural/Black/Computer
- Unit: mm

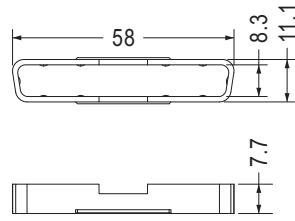

Part No.	Package
DTC-37M	250

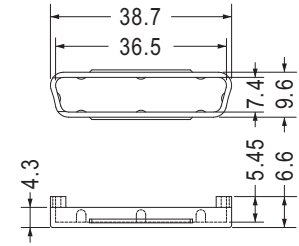

Part No.	Package
DTC-50S	500

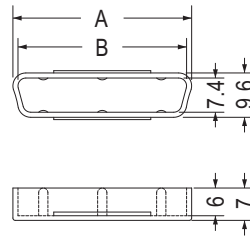

Part No.	A	B	Package
DTC-50M	38.7	36.5	500
DTC-68M	50.2	48.0	

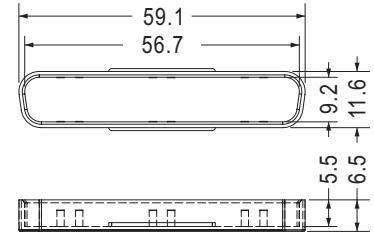

Part No.	Package
DTC-37ML	250



- Material: Nylon 66 (UL)
- Flame Class: 94V-2/94V-0
- Color: Natural/Black
- Unit: mm

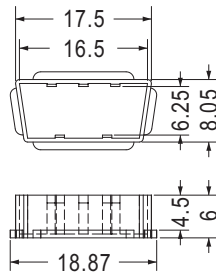

Part No.	Package
DTC-20	1000

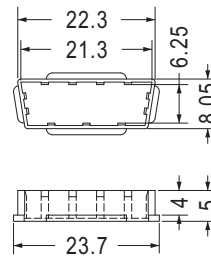

Part No.	Package
DTC-26	1000

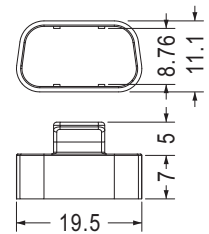

- Color: Black/Gray

Part No.	Package
DTCB-1	500

DVI防塵蓋 CONNECTOR COVER

用途：用於連接器防塵與保護。



- Material: PP (UL)
- Flame Class: 94HB
- Color: Natural/Black
- Unit: mm

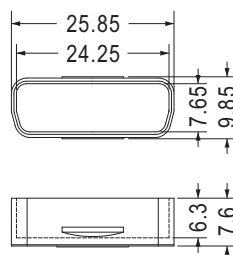

Part No.	Package
DVIC-1	500

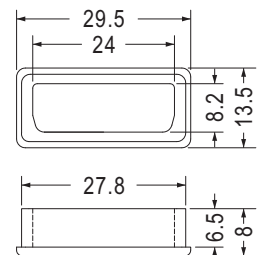

- Material: TPE

Part No.	Package
DVIC-2-N	500

DVI防塵蓋 CONNECTOR COVER

用途：用於連接器防塵與保護。



- Material: PE
- Color: Black
- Unit: mm

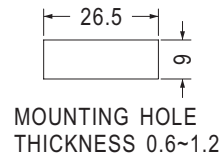
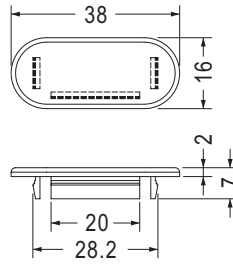

Part No.	Package
DVI-1	500



- Material: Nylon 66 (UL)
- Flame Class: 94V-2/94V-0
- Color: Natural/Black
- Unit: mm

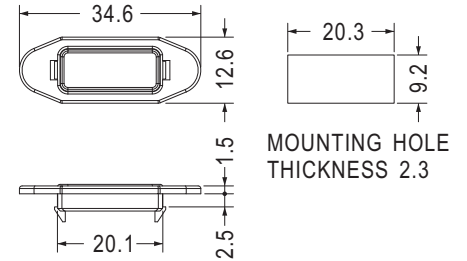
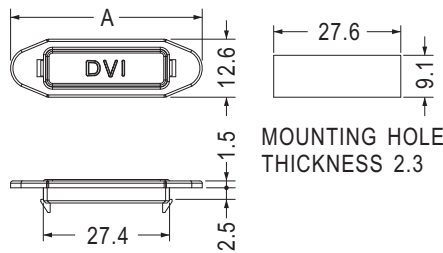

Part No.	A	Package
DVI-2	41.6	1000
DVI-4	38.6	

Part No.	Package
DVI-3	1000

VGA防塵蓋 CONNECTOR COVER

用途：VGA端子之防塵蓋、美觀。



- Material: PP (UL)
- Flame Class: 94HB
- Color: Natural/Transparent
- Unit: mm

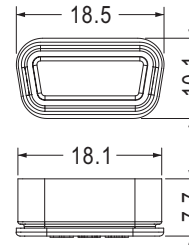

Part No.	Package
VGAC-1	500

防塵蓋 CONNECTOR COVER

用途：用於防塵與保護用。



- Material: Nylon 66 (UL)
- Flame Class: 94V-2/94V-0
- Color: Natural/Black
- Unit: mm

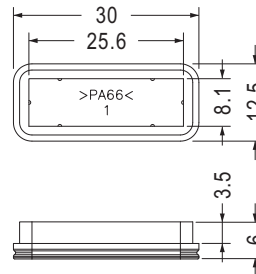

Part No.	Package
PCIEC-1	1000



- Material: PC (UL)
- Flame Class: 94V-0
- Color: Transparent
- Unit: mm

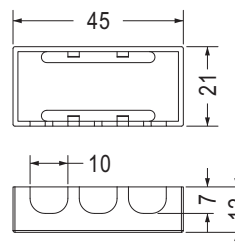

Part No.	Package
COVER-25	200

防塵蓋 CONNECTOR COVER

用途：用於連接器防塵與保護。



- Material: Nylon 66 (UL)
- Flame Class: 94V-2/94V-0
- Color: Natural/Black
- Unit: mm

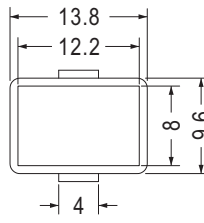

Part No.	Package
VGAB-1	1000

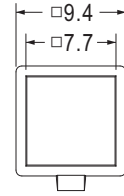

Part No.	Package
VGAB-2	1000

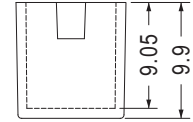
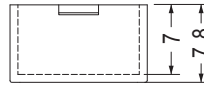

- Material: PE
- Color: Black
- Unit: mm

用途：用於汽車連接器防塵與保護。

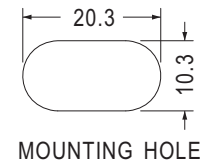
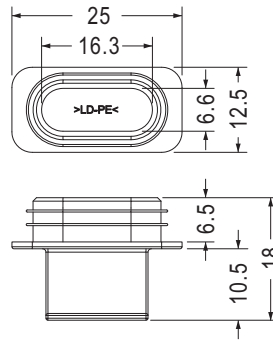

Part No.	Package
CVA-5	1000

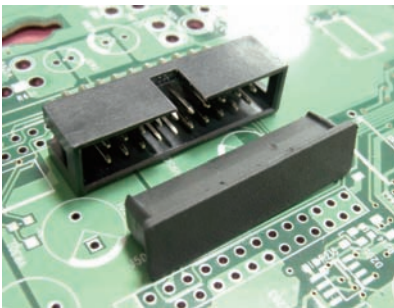

- Material: PE
- Color: Black
- Unit: mm

用途：用於IDE Connector防塵與保護。

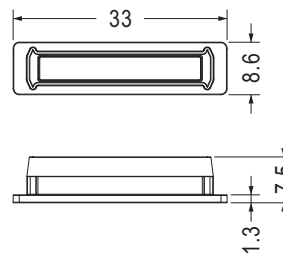

Part No.	Package
DKCV-1	500



- Material: NBR
- Color: Black
- Unit: mm

用途：用於SFP連接器防塵與保護用。

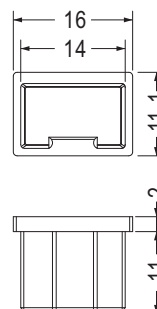

Part No.	Package
TF-246	1000

防塵蓋 CONNECTOR COVER

用途：用於連接器防塵與保護。

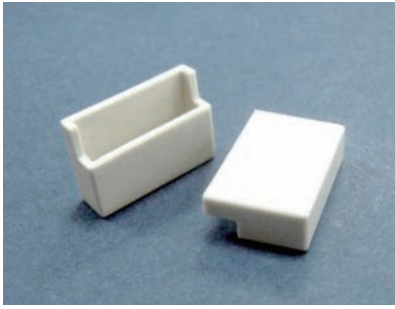

- Material: PBT (UL)
- Flame Class: 94V-0
- Color: Natural
- Unit: mm

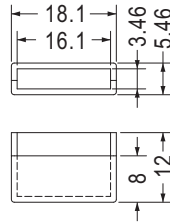

Part No.	Package
COVER-4	500

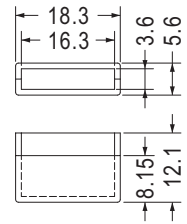

Part No.	Package
COVER-7	500

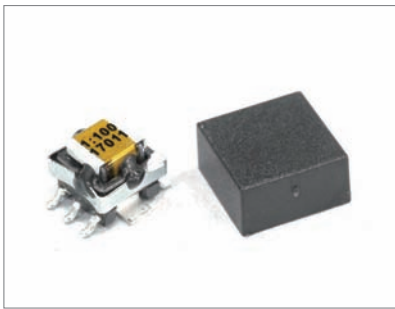

- Material: Nylon 66 (UL)
- Flame Class: 94V-2/94V-0
- Color: Natural/Black
- Unit: mm

用途：用於電子零件晶體之防塵與保護。

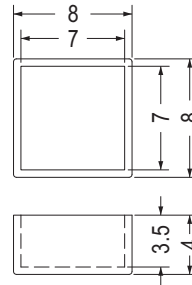

Part No.	Package
COVER-14	1000



- Material: Nylon 66 (UL)
- Flame Class: 94V-2/94V-0
- Color: Natural/Black
- Unit: mm

用途：用於防塵與保護用。

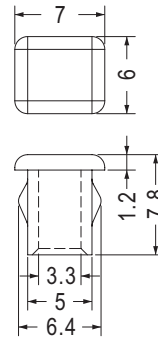

Part No.	Package
COVER-6	1000



- Material: Nylon 66 (UL)
- Flame Class: 94V-2/94V-0
- Color: Natural/Black
- Unit: mm

用途：用於PC250端子防塵蓋。

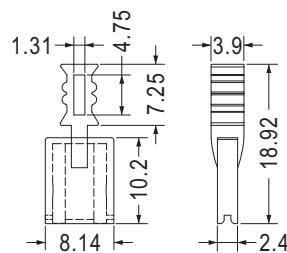

Part No.	Package
CVP-250	1000

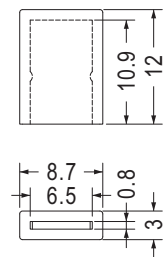

- Material: PE

Part No.	Package
KPS-42	1000

1394端子防塵蓋 CONNECTOR COVER

用途：用於1394接頭防塵與保護。



- Material: PE
- Color: Black
- Unit: mm

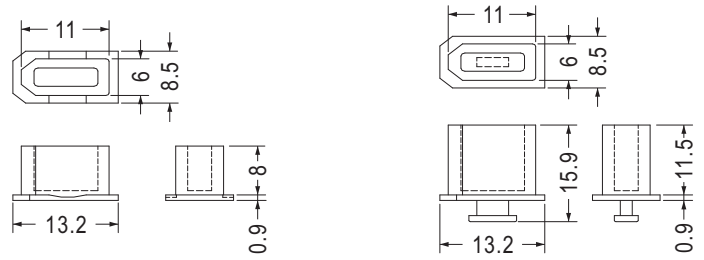

Part No.	Package
CVR-1394	1000

Part No.	Package
CVR-1394S	1000



- Material: PP (UL)
- Flame Class: 94HB
- Color: Gray
- Unit: mm

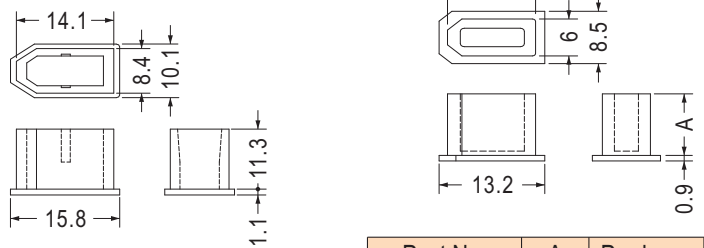

Part No.	Package
CVR-1394-1	1000

Part No.	A	Package
CVR-1394-2	10.0	1000
CVR-1394-3	11.5	



- Material: PE
- Color: Black/Computer
- Unit: mm

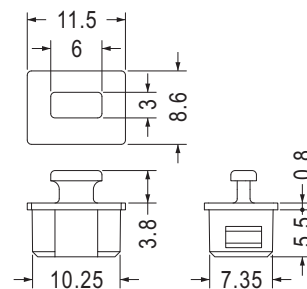

Part No.	Package
CVRB-1394	1000

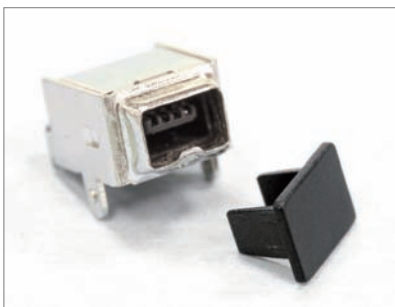

- Material: ABS (UL)
- Flame Class: 94HB
- Color: Black
- Unit: mm

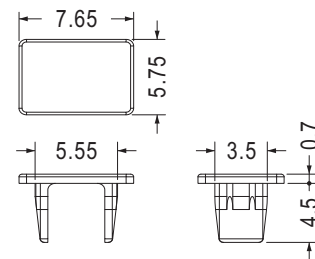

Part No.	Package
CVRD-1394	1000

端子防塵蓋 CONNECTOR COVER

用途：做為端子之防塵與保護。



- Material: TPE
- Color: Black
- Unit: mm

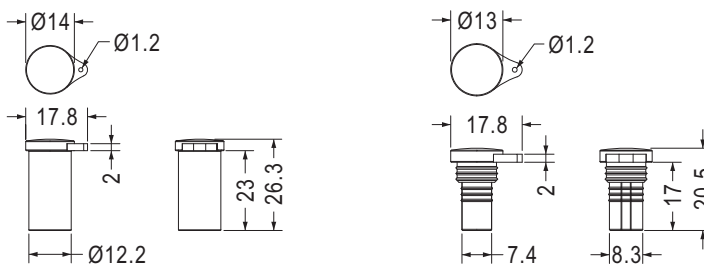

Part No.	Package
SCCVA-3	1000

Part No.	Package
SCCVA-4	1000

電源插頭防塵蓋 POWER CONNECTOR COVER

用途：保護電源插頭之防塵、防氧化。



- Material: PE
- Color: Natural
- Unit: mm

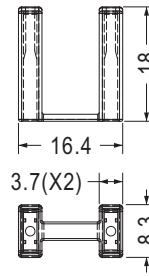

- Material: PP

Part No.	Package
PLCC-14	250

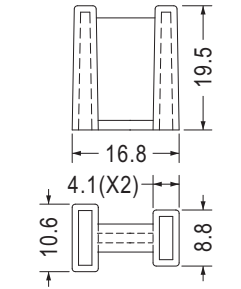

Part No.	Package
PLCC-1	500

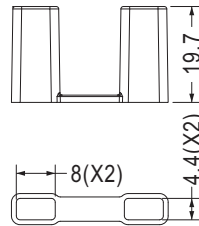

Part No.	Package
PLCC-8	1000

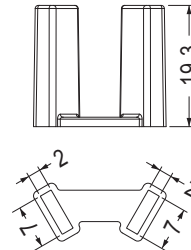

Part No.	Package
PLCC-9	1000

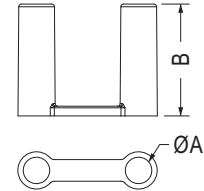

Part No.	A	B	Package
PLCC-10	4.9	20.7	1000
PLCC-11	4.1	20.7	
PLCC-20	5.3	18.0	

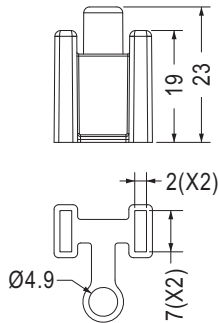

Part No.	Package
PLCC-13	500

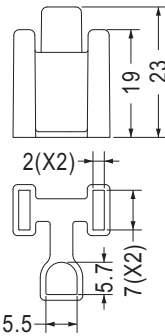

Part No.	Package
PLCC-18	500

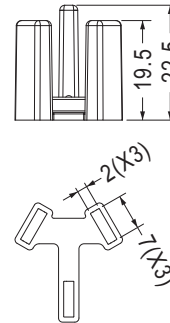

Part No.	Package
PLCC-15	1000

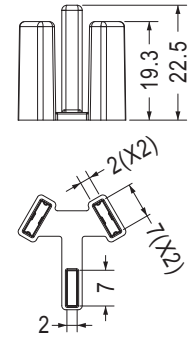

Part No.	Package
PLCC-19	1000

插頭保護座 SOCKET COVER

用途：用於電源插座後端，防短路、保護用。



- Material: Nylon 66 (UL)
- Flame Class: 94V-2/94V-0
- Color: Black
- Unit: mm

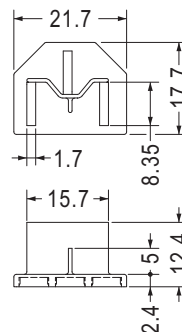

Part No.	Package
PLCD-1	500

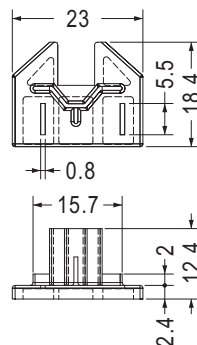

Part No.	Package
PLCD-2	500

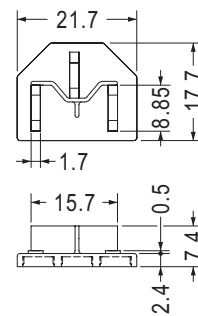

Part No.	Package
PLCD-3	500

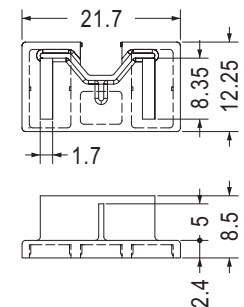

Part No.	Package
PLCD-4	500

電源插座防塵蓋 POWER CONNECTOR COVER

用途：用於三插電源座防塵與保護。



- Material: ABS (UL)
- Flame Class: 94HB
- Color: Black
- Unit: mm

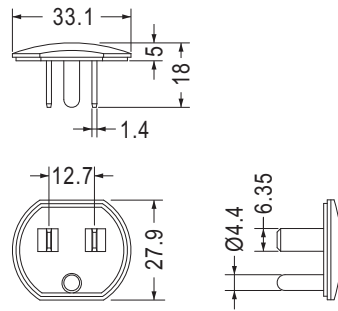

Part No.	Package
PLCC-2	500



- Material: PP
- Color: White
- Unit: mm

用途：用於兩插電源座防塵與保護。

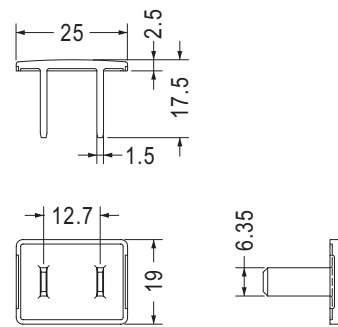

Part No.	Package
PLCC-3	500

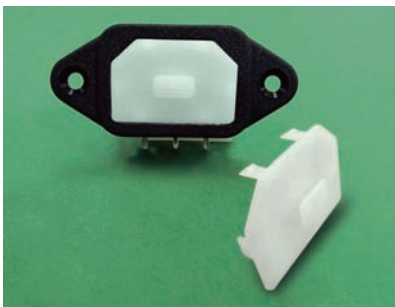

- Material: Nylon 66 (UL)
- Flame Class: 94V-2/94V-0
- Color: Natural/Black
- Unit: mm

用途：用於電源座之防塵與保護。

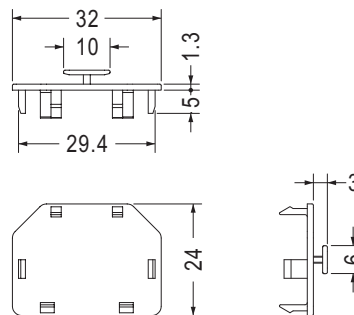

Part No.	Package
PLCC-5	500



- Material: PE
- Color: Black
- Unit: mm

用途：用於電源座之防塵與保護。

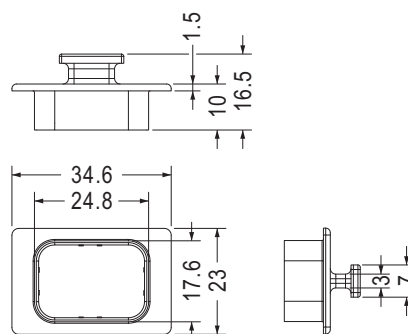

Part No.	Package
PLCC-16	500

電源插座防塵蓋 POWER CONNECTOR COVER

用途：用於電源插座接頭防塵與保護。



- Material: PE
- Color: Black/Yellow
- Unit: mm

- Material: TPE (UL)
- Flame Class: 94V-0
- Color: Black
- Unit: mm

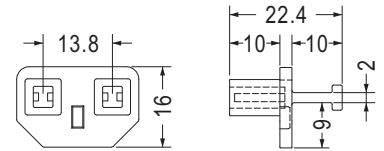
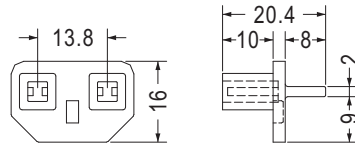
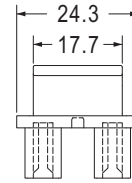
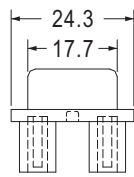

Part No.	Package
PLC-1	250

Part No.	Package
PLC-3	250



- Material: Nylon 66 (UL)
- Flame Class: 94V-2/94V-0
- Color: Natural/Black
- Unit: mm

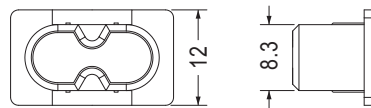
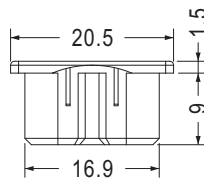

Part No.	Package
PLC-2	500

7

防塵蓋 IP CONNECTOR HOUSING

用途：用於機板上，保護電源插座避免刮傷。



- Material: Nylon 66 (UL)
- Flame Class: 94V-2/94V-0
- Color: Natural/Black
- Unit: mm

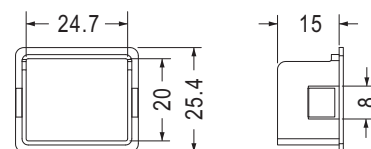
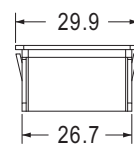

Part No.	Package
PLCC-7	1000

零件蓋 CONNECTOR COVER

用途：用於零件之防塵與保護。



- Material: ABS (UL)
- Flame Class: 94HB
- Color: Black
- Unit: mm

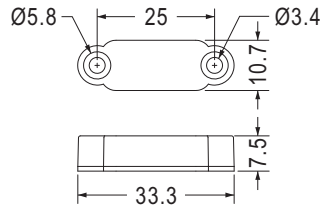

Part No.	Package
CVR-2508	1000

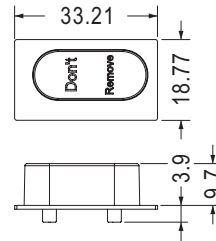

Part No.	Package
CVR-3318	1000

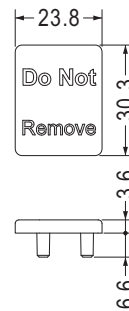

Part No.	Package
CVR-3325	1000

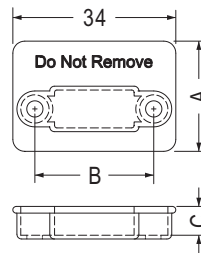

Part No.	A	B	C	Package
CVR-3421	21.5	25.0	5.8	1000
CVR-3423	23.0	24.8	6.0	

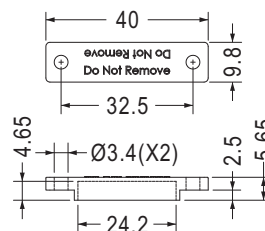

Part No.	Package
CVR-4098	500

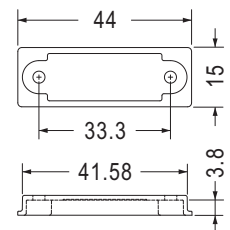

Part No.	Package
CVR-4415	1000

防塵蓋 CONNECTOR COVER

用途：用於連接器防塵與保護。



- Material: ABS (UL)
- Flame Class: 94HB
- Color: Black
- Unit: mm

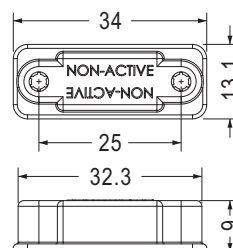

Part No.	Package
CVR-3413-1	500

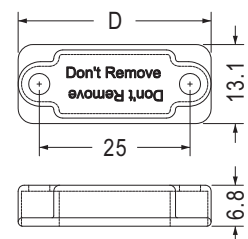

Part No.	D	Package
CVR-3213	32.0	1000
CVR-3413	34.0	

防塵蓋 CONNECTOR COVER

用途：用於防塵與保護。



- Material: ABS (UL)
- Flame Class: 94HB
- Color: Black
- Unit: mm

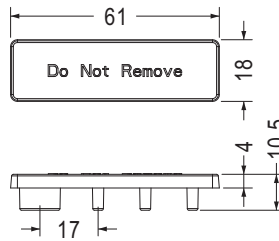

Part No.	Package
CVR-6118	500

電源蓋 POWER SUPPLY CAP

用途：用於電源線之固定與保護，避免脫落。

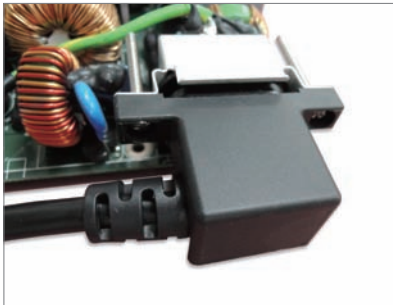

- Material: Nylon 66 (UL)
- Flame Class: 94V-2/94V-0
- Color: Natural/Black
- Unit: mm

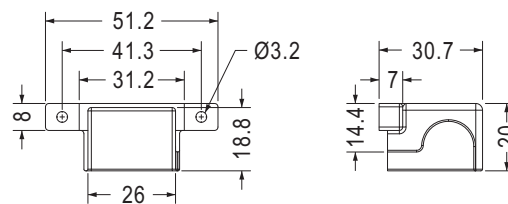

Part No.	Package
CVA-8	500

防塵蓋 CONNECTOR COVER

用途：用於防塵與保護用。



- Material: Nylon 66 (UL)
- Flame Class: 94V-2/94V-0
- Color: Natural/Black
- Unit: mm

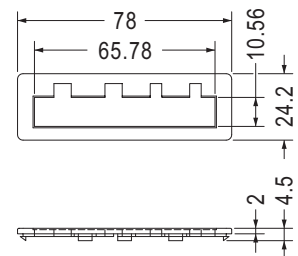
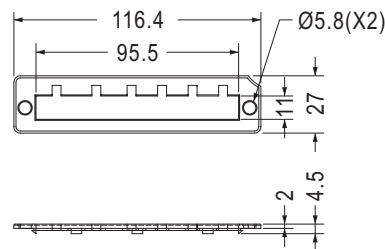

Part No.	Package
PCIE-1	500

Part No.	Package
PCIE-2	500

機板電源保護蓋 POWER CONNECTOR COVER

用途：保護主機板電源端子，防塵與美觀。

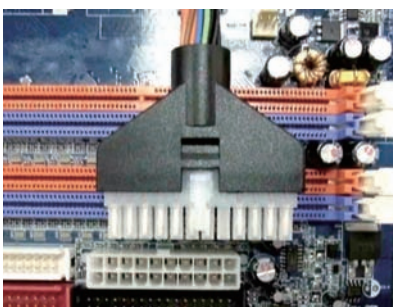

- Material: PE
- Color: Black
- Unit: mm

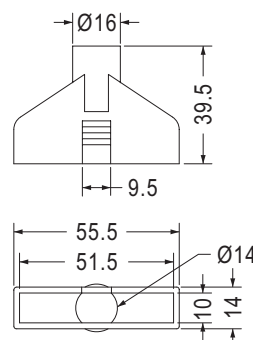

Part No.	Package
STAT-CV24	250

連接器防塵蓋 CONNECTOR COVER

用途：用於連接器防塵與保護。

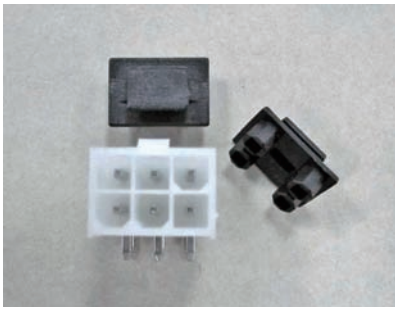

- Material: PP
- Color: Black
- Unit: mm

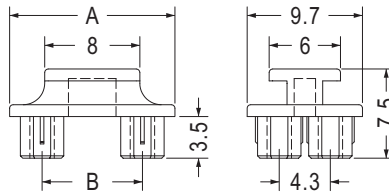

Part No.	A	B	Package
PWIC-6	13.9	8.4	500
PWIC-8	18.0	12.7	

連接器座 CONNECTOR HOUSING

用途：用於連接器之保護。

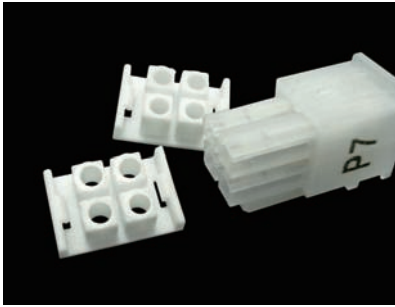

- Material: Nylon 66 (UL)
- Flame Class: 94V-2/94V-0
- Color: Natural/Black
- Unit: mm

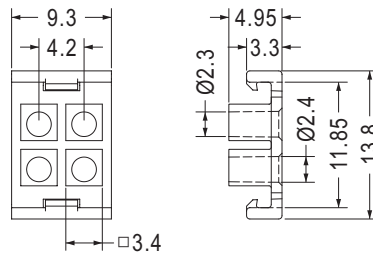

Part No.	Package
012-958	1000

耳機孔護套 HEADPHONE JACK DUST PLUG

用途：用於3.5 mm耳機孔，防塵與保護。



- Material: Nylon 66 (UL)
- Flame Class: 94V-2/94V-0
- Color: Natural/Black
- Unit: mm

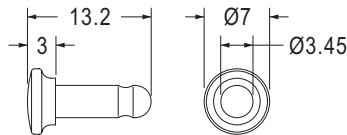

插入耳機孔會啟動靜音模式
Activates silent mode function,
when plug into headphone jack.

Part No.	Package
MHSC-1	2000

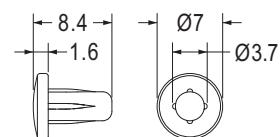

- Material: PP
- Color: Black

Part No.	Package
MHSC-2	2000

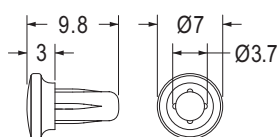

Part No.	Package
MHSC-3	2000

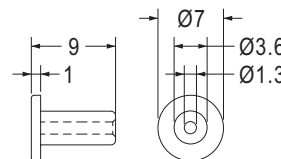

Part No.	Package
MHSC-4	2000

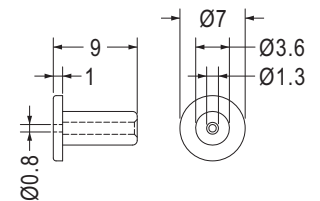

Part No.	Package
MHSC-4-1	2000

耳機孔護套 HEADPHONE DUST PLUG

用途：用於3.5 mm耳機孔，防塵與保護。



- Material: TPE
- Color: Black
- Unit: mm

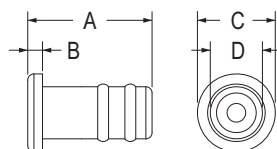

Part No.	A	B	C	D	耳機孔	Package
MHSC-5	8.0	0.95	5.0	3.35	Ø3.5	2000
MHSC-6	6.0	1.0	4.2	2.2	Ø2.5	

Ø3.5音源線防塵蓋 Ø3.5 mm AUDIO COVER

用途：用於Ø3.5 mm音源線防塵與保護。



- Material: PP
- Color: Natural
- Unit: mm

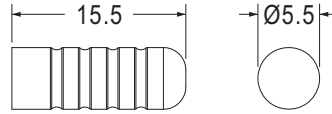

Part No.	Package
EARC-3.5	2000

防塵蓋 CONNECTOR COVER

用途：用於PC板金手指防塵與保護。

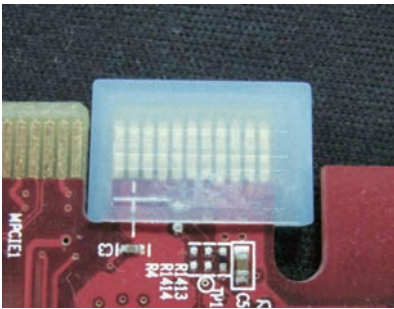

- Material: PE
- Color: Natural/Transparent Blue
- Unit: mm

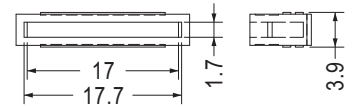
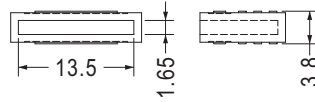
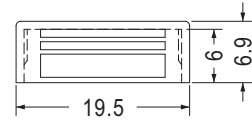
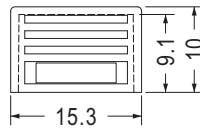

Part No.	Package
GDFC-13	2000

Part No.	Package
GDFC-17	2000

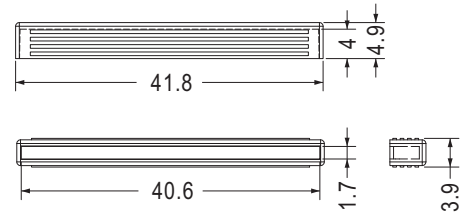
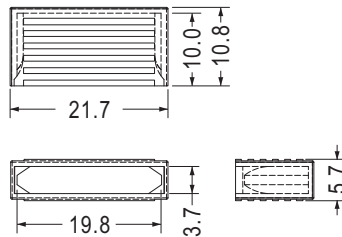
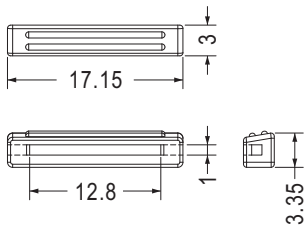

- Material: Nylon 66 (UL)
- Flame Class: 94V-2/94V-0
- Color: Blue

- Color: Yellow

Part No.	Package
GDFC-14	2000

Part No.	Package
GDFC-20	1000

Part No.	Package
GDFC-40	1000

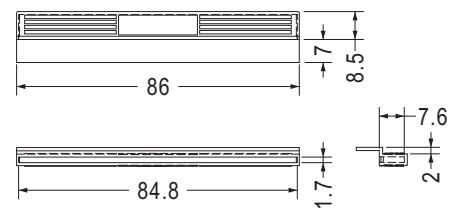
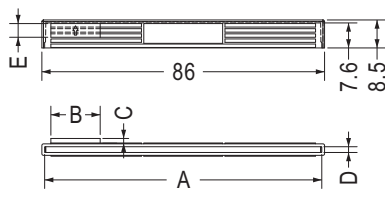

Part No.	A	B	C	D	E	Package
GDFC-83	84.31	15.0	1.43	1.75	4.16	500
GDFC-84	84.8	/	/	1.7	/	

Part No.	Package
GDFC-84-2N	1000

防塵蓋 CONNECTOR COVER

用途：用於PC板金手指防塵與保護。

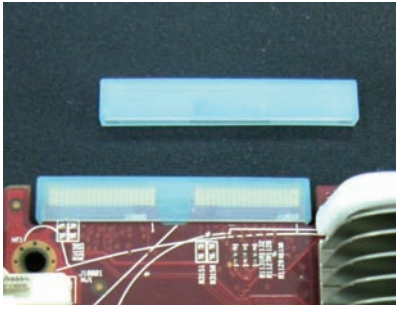

- Material: PE
- Color: Black/Transparent Bule
- Unit: mm

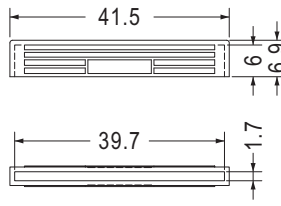

Part No.	Package
GDFC-39	1000

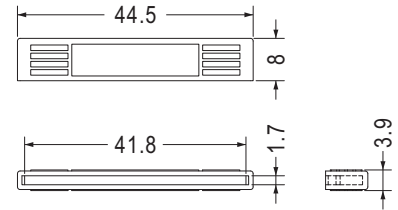

Part No.	Package
GDFC-42	500

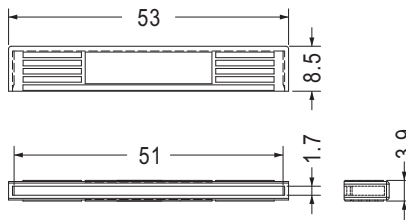
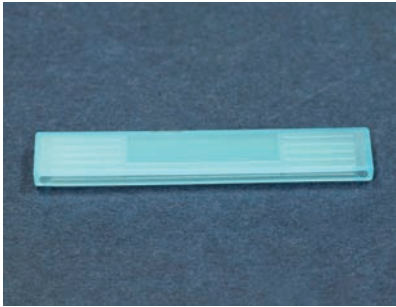

Part No.	Package
GDFC-51	500

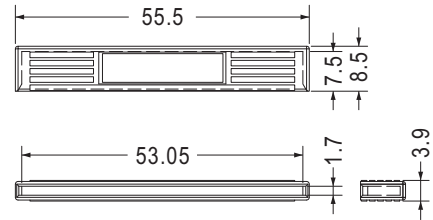

Part No.	Package
GDFC-53	500



- Material: PC+ABS (UL)
- Flame Class: 94V-0
- Color: Orange
- Unit: mm

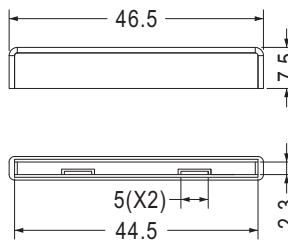

Part No.	Package
HANE-63	1000



- Material: PE
- Color: Bule
- Unit: mm

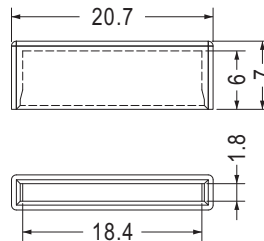

Part No.	Package
GDFC-18N	1000

防塵套 CONNECTOR COVER

用途：用於PC板金手指之絕緣與防塵。

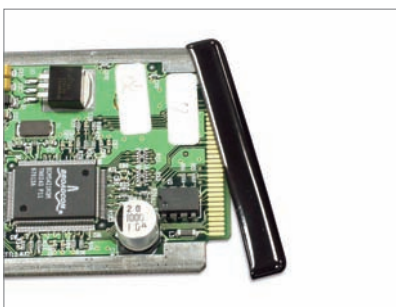

- Material: Soft P.V.C
- Color: Black
- Unit: mm

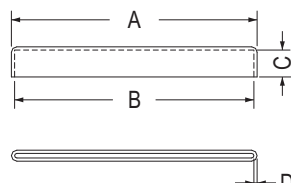

THICKNESS 1.7~1.8

Part No.	A	B	C	D	Package
FHCV-52	51.8	49.8	11.5	1.0	1000
FUSE-5	65.9	63.5	7.0	1.2	
FUSE-6	91.4	89.0	10.0	1.2	

連接器座 CONNECTOR HOLDER

用途：用於連接器防塵與保護。

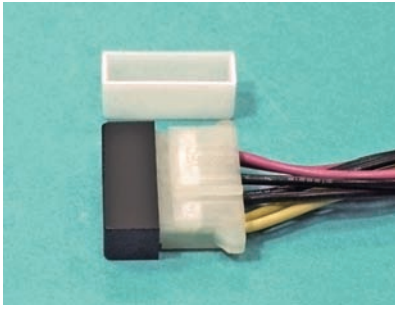

- Material: Nylon 66 (UL)
- Flame Class: 94V-2/94V-0
- Color: Natural/Black
- Unit: mm

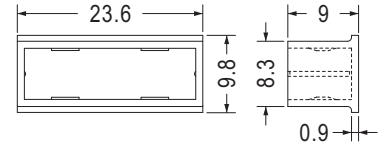
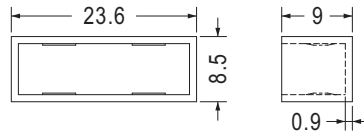

Part No.	Package
FHC-1	500

Part No.	Package
FHC-2	500

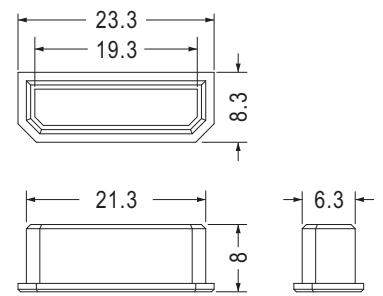
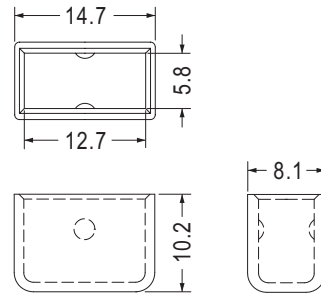
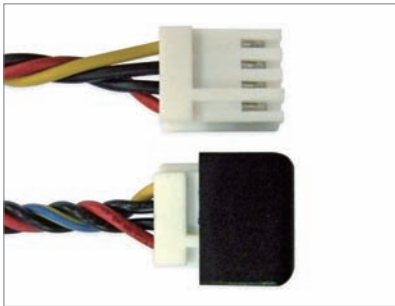

Part No.	Package
FHC-3	1000

Part No.	Package
FHC-4	500

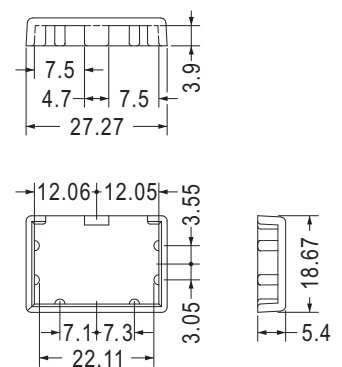
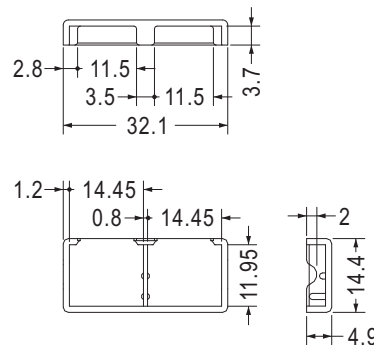
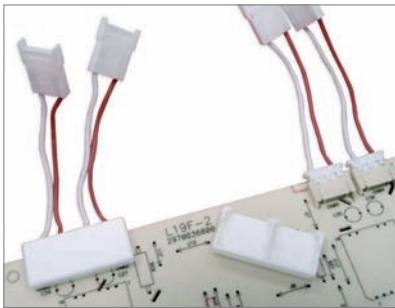

Part No.	Package
CDELT-2	500

Part No.	Package
CDELT-3	500

防塵蓋 CONNECTOR COVER

用途：用於連接器防塵與保護。



- Material: PBT (UL)
- Flame Class: 94V-0
- Color: Natural
- Unit: mm

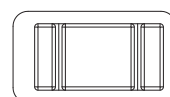
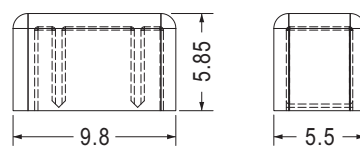

Part No.	Package
FHCA-1	1000

PCMIC卡保護蓋 PCMIC CARD SOCKET COVER

用途：用於PCMIC卡保護用。



- Material: ABS (UL)
- Flame Class: 94HB
- Color: Black/White
- Unit: mm

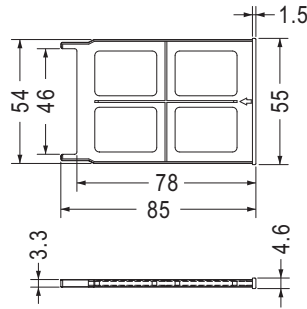

Part No.	Package
PCMIC-1	100

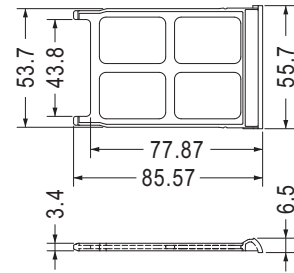

Part No.	Package
PCMIC-2	100

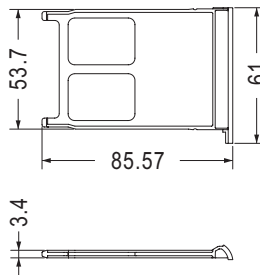

Part No.	Package
PCMIC-3	100

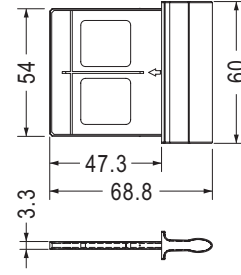

Part No.	Package
PCMIC-4	100

面板 CARD BEZEL

用途：用於IC卡讀卡機之面板。



- Material: PC+ABS (UL)
- Flame Class: 94V-0
- Color: Black
- Unit: mm

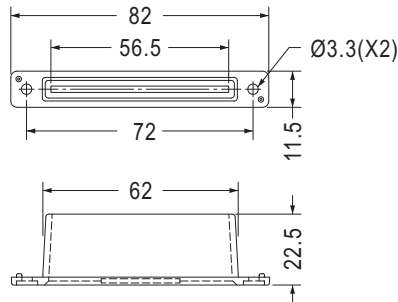

Part No.	Package
CRDCV-56	100

DDR防塵蓋 DDR COVER

用途：用於DDR記憶體之防塵。



- Material: PC+ABS (UL)
- Flame Class: 94V-0
- Color: Black
- Unit: mm

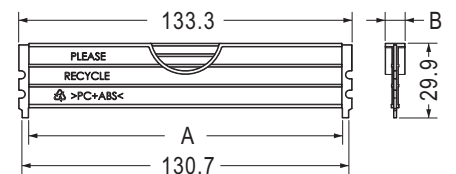
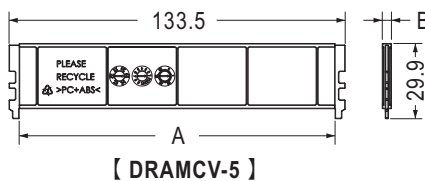

Part No.	A	B	For	Package
DRAMCV-2	125.5	8.0	DDR3	50
DRAMCV-4	125.3	8.0	DDR4	
DRAMCV-4S	125.3	7.5	DDR5	80
DRAMCV-5	125.5	3.65		

DRAM固定帶 DRAM FIXATION STRAP

用途：用於DRAM記憶卡固定。

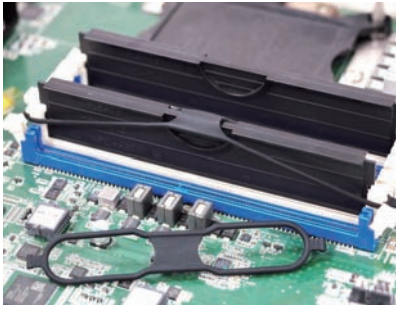

- Material: Silicon Rubber
- Color: Black
- Unit: mm

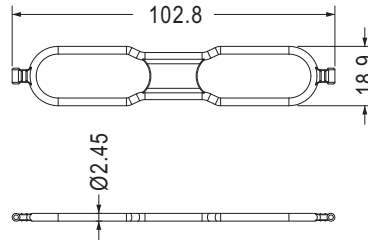

使用說明
Installation Step

Part No.	Package
DRLC-1I	100

D-SUB保護蓋 D-SUB COVER

用途：用於D-SUB之保護用。



- Material: PC+ABS (UL)
- Flame Class: 94V-0
- Color: Black
- Unit: mm

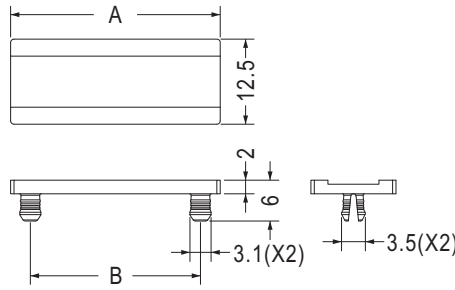

Part No.	A	B	Package
CVR-3012	30.8	25.0	1000
CVR-5312	53.0	47.0	500
CVR-6912	69.3	63.5	

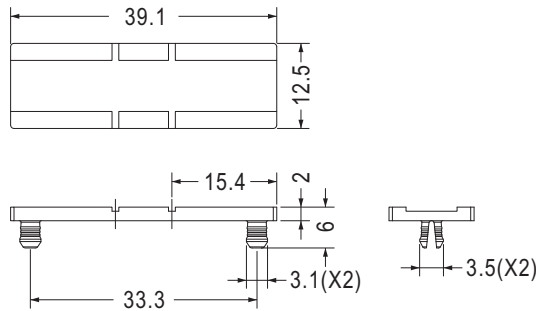

Part No.	Package
CVR-3912	500

高壓防塵蓋 PLASTIC COVER

用途：用於開關電源高壓部分，防止蟑螂入侵，避免造成短路，可做為絕緣及防塵、保護用。
(可依客戶PC板另外客製開模設計)



- Material: Nylon 66 (UL)
- Flame Class: 94V-2/94V-0
- Color: Natural/Black
- Unit: mm

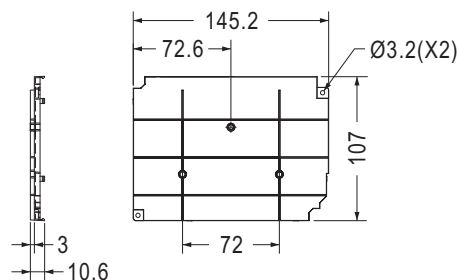

Part No.	Package
CV145107	500

SD卡保護蓋 SD CARD SOCKET COVER

用途：用於SD卡保護用。



- Material: ABS (UL)
- Flame Class: 94HB
- Color: Black
- Unit: mm

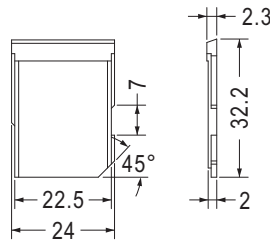

Part No.	Package
SD-24	500

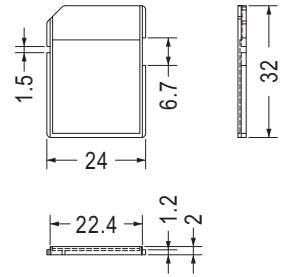

Part No.	Package
SD-25	500

SIM卡保護蓋 SIM CARD SOCKET COVER

用途：SIM卡之防塵與保護。



- Material: PC
- Color: Black
- Unit: mm

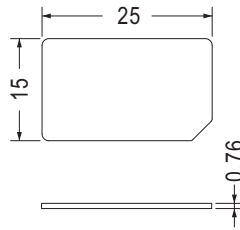

Part No.	Package
FR2515N	1000

MICRO SD卡保護蓋 CARD SOCKET COVER

用途：用於Micro Sd卡保護用。



- Material: PC+ABS (UL)
- Flame Class: 94V-2
- Color: Black
- Unit: mm

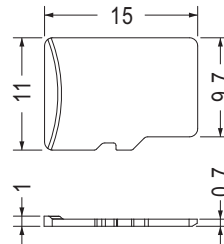

Part No.	Package
MIOSD-1	1000

防塵蓋 CONNECTOR COVER

用途：用於塑膠機殼螺絲孔之塞頭。



- Material: Nylon 66 (UL)
- Flame Class: 94V-2/94V-0
- Color: Natural/Black
- Unit: mm

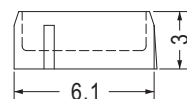
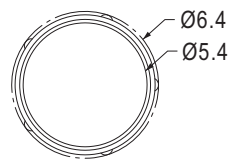

Part No.	Package
CAPX-6	2000

開關蓋 SWITCH COVER

用途：用於開關保護用。



- Body Material: Nylon 66 (UL)
- Cover Material: PC (UL)
- Flame Class: 94V-2/94V-0
- Color: Black
- Unit: mm

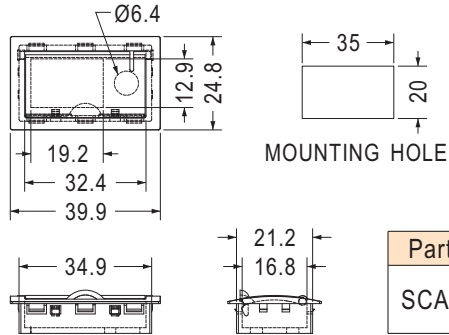

Part No.	Part No.	Package
SCAB-2F	SCAB-2A SCAB-2B	21



- Material: Nylon 66 (UL)
- Flame Class: 94V-2/94V-0
- Color: Natural/Black
- Unit: mm

用途：用於開關之按鍵。

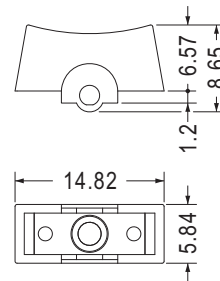

Part No.	Package
TSC-29	1000

開關遮板 SWITCH COVER

用途：用於開關蓋保護用。



- Material: ABS (UL)
- Flame Class: 94HB
- Color: Black
- Unit: mm

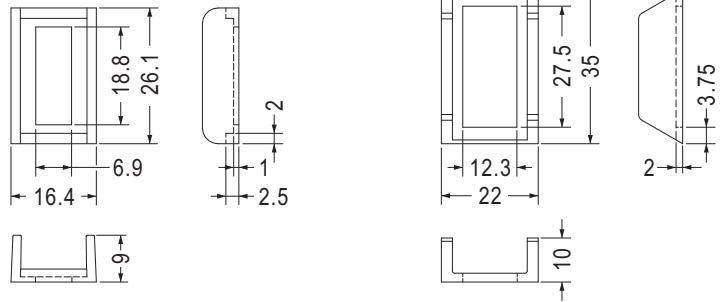

Part No.	Package
SCAB-7	500

Part No.	Package
SCAB-12	500



- Material: Nylon 66 (UL)
- Flame Class: 94V-2/94V-0
- Color: Black
- Unit: mm

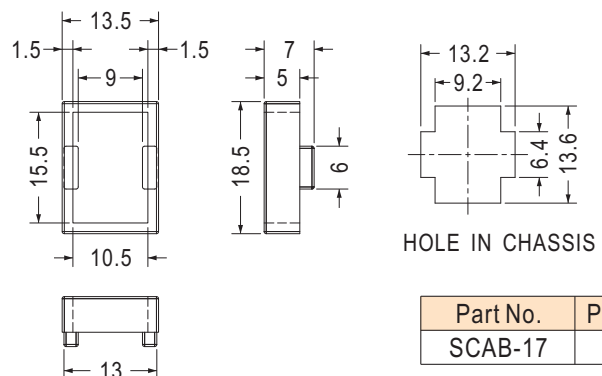

Part No.	Package
SCAB-17	500

尼龍鉚釘 SNAP RIVET

用途：用於PC板、鐵板零件固定，代替螺絲，省時不需工具，結合力強。



- Material: Nylon 66 (UL)
- Flame Class: 94V-2/94V-0
- Color: Natural/Black
- Unit: mm

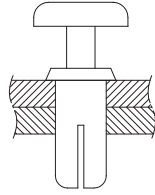
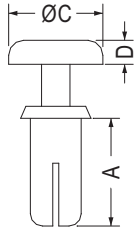

MOUNTING HOLE: ØG
THICKNESS: T

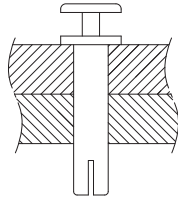
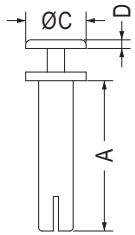

MOUNTING HOLE: ØG
THICKNESS: T

【 SR2-4, SR2-5, SR2-6, SR2-7, SR2-9 】

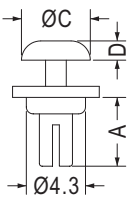

MOUNTING HOLE: ØG
THICKNESS: T

【 SR2.5-5.8 】

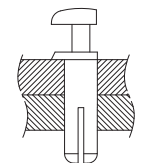
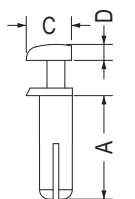

MOUNTING HOLE: ØG
THICKNESS: T

【 SR3.5-11D 】

Part No.	A	C	D	G	T	Package
SR2-2.4	2.4	4.2	1.2	2.0	0.6~1.2	1000
SR2-3.2	3.2	4.2	1.2	2.0	1.3~2.0	2000
SR2-3.2S	3.2	4.2	1.2	2.0	1.3~1.9	
SR2-4	4.0	3.5	0.5	2.0	2.3~2.5	1000
SR2-5	5.0	4.8	0.75	2.0	2.5~3.5	
SR2-5.6	5.6	4.2	1.2	2.0	3.7~4.4	
SR2-6	6.0	4.8	0.75	2.0	3.5~4.5	
SR2-6.4	6.4	4.2	1.2	2.0	4.5~5.2	
SR2-7	7.0	4.8	0.75	2.0	4.5~5.5	
SR2-9	8.7	3.5	0.5	2.0	7.2	
SR2.5-5.8	5.0	5.0	1.4	2.4	2.2~3.2	
SR2.6-3.2	3.2	5.0	1.7	2.6~2.7	1.0~2.0	
SR2.6-4.2	4.2	5.0	1.7	2.6~2.7	2.0~3.0	
SR2.6-4.8	4.8	5.0	1.4	2.6~2.7	2.5~3.4	
SR2.6-5.5	5.5	5.0	1.4	2.6~2.7	3.0~4.3	
SR2.6-6.4	6.4	5.0	1.4	2.6~2.7	4.3~5.0	
SR2.6-7.2	7.2	5.0	1.4	2.6~2.7	5.0~5.8	
SR2.8-24	24.0	6.0	1.7	2.8	18.5~19.5	
SR3-3.5	3.6	6.3	1.7	3.0~3.1	1.0~2.0	
SR3-4.5	4.5	6.3	1.7	3.0~3.1	2.0~3.0	
SR3-5	5.0	6.3	1.7	3.0~3.1	2.5~3.5	
SR3-5.5	5.5	6.3	1.7	3.0~3.1	3.0~3.5	
SR3-5.5-2	5.5	6.3	1.7	3.0	3.0~4.0	
SR3-6	6.0	6.3	1.7	3.0~3.1	3.5~4.5	
SR3-6.5	6.5	6.3	1.7	3.0~3.1	4.0~4.5	
SR3-6.5-1	6.5	6.3	1.7	3.0	4.0~5.0	
SR3-7.5	7.5	6.3	1.7	3.0~3.1	5.0~6.0	
SR3-8	8.1	6.3	1.7	3.0~3.1	5.5~6.5	
SR3-9	9.1	6.3	1.7	3.0~3.1	6.5~7.5	
SR3-10	10.0	6.3	1.7	3.0~3.1	7.5~8.5	
SR3-12	12.0	6.3	1.7	3.0~3.1	7.0~9.0	
SR3-13	13.2	6.3	1.7	3.0~3.1	10.0~11.0	
SR3-15	15.5	6.2	1.7	3.0~3.1	11.5~13.0	
SR3-17	17.0	3.2	1.7	3.0~3.1	12.0~14.0	
SR3-18.5	18.5	6.3	1.7	3.0~3.1	15.0~16.5	
SR3.2-4.5	4.5	6.3	1.7	3.2	1.5~3.0	
SR3.5-3.5	3.5	6.3	1.7	3.5	1.5~2.0	
SR3.5-4.5	4.5	6.3	1.7	3.5	2.0~3.0	
SR3.5-5	5.0	6.3	1.7	3.5	2.5~3.5	
SR3.5-5.5	5.5	6.3	1.7	3.5	3.0~4.0	
SR3.5-6	6.0	6.3	1.7	3.5	3.0~4.0	
SR3.5-7	7.0	6.3	1.7	3.5	4.5~5.5	
SR3.5-7.5	7.5	6.3	1.7	3.5	5.0~6.0	
SR3.5-8	8.0	6.3	1.7	3.5	5.7~6.6	
SR3.5-9	9.0	6.3	1.7	3.5	6.0~7.0	
SR3.5-11D	11.0	4.9	1.7	3.5~3.6	6.5~7.5	
★SR3.5-18.5	18.5	6.3	1.7	3.5	14.5~16.0	
SR3.5-23	23.0	6.3	1.7	3.5	18.5~20.0	
★SR3.5-24	24.0	6.3	1.7	3.5	20.5~21.5	
SR3.5-32	32.0	6.3	1.7	3.5	28.0	
SR3.8-6.5	6.5	6.3	2.0	3.8	4.0~4.5	

尼龍鉚釘 SNAP RIVET

用途：用於PC板、鐵板零件固定，代替螺絲，省時不需工具，結合力強。



- Material: Nylon 66 (UL)
- Flame Class: 94V-2/94V-0
- Color: Natural/Black
- Unit: mm

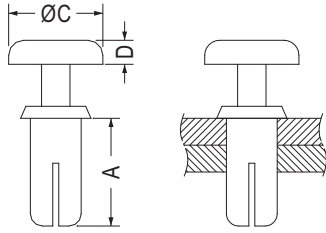

MOUNTING HOLE: ØG
THICKNESS: T

Part No.	A	C	D	G	T	Package	
SR4-4.6	4.6	7.8	1.9	4.0~4.1	2.5~3.5	1000	
SR4-5	5.0	7.8	1.9	4.0	2.5~3.5		
SR4-6	6.1	7.8	1.9	4.0	3.5~4.5		
SR4-7	7.1	8.0	2.0	4.0	4.5~5.5		
SR4-8	8.1	8.0	2.0	4.0	5.5~6.5		
SR4-9	9.0	8.0	2.0	4.0	6.5~7.5		
SR4-10	10.0	8.0	2.0	4.0	7.5~8.5		
SR4-12	12.0	8.0	2.0	4.0	9.5~10.5		
SR4-14	13.7	8.0	2.0	4.0	11.0~12.0		
SR4-15	15.3	8.0	2.0	4.0	11.5~13.0		
SR4-15.5	15.5	8.0	2.0	4.0	11.5~13.0		
SR4-20	20.0	8.0	2.0	4.0	15.0~17.0		500
SR4-25	24.5	8.0	2.0	4.0	22.0~23.0		
SR4.3-5	5.0	7.8	1.9	4.3	2.5~3.5		1000
★SR4.5-21.3	21.3	8.0	1.7	4.5	17.5	500	
SR5-4.5	4.6	8.9	2.2	5.0	1.5~2.5	1000	
SR5-5.5	5.5	8.9	2.0	5.0	2.5~3.5		
SR5-6.5	6.5	8.9	2.2	5.0	3.5~4.5		
SR5-7.5	7.5	8.9	2.2	5.0	4.5~5.5		
SR5-8.5	8.4	8.9	2.2	5.0	5.5~6.5		
SR5-9.5	9.5	8.9	2.1	5.0	5.5~7.5		
SR5-10.5	10.5	8.9	2.1	5.0	6.5~8.5		
SR5-10.5L	10.5	10.0	2.1	5.0	6.5~8.5		
SR5-12	12.0	8.9	2.2	5.0	8.0~9.0		
SR5-14	14.0	8.9	2.2	5.0	10.0~11.0		
SR5-16	16.0	8.9	2.2	5.0	12.0~13.0		
SR5-18	18.0	8.9	2.2	5.0	14.0~15.0		
SR6-6	6.0	12.0	2.5	6.0	2.5~4.0		1000
SR6-8	8.0	12.0	3.0	6.0	4.5~6.0		
SR6-10.5	10.5	12.0	3.0	6.0	7.5~8.5		
SR6-12	12.0	12.0	3.0	6.0	8.0~9.0		
SR6-14	14.0	12.0	3.0	6.0	10.0~11.0		
SR6-16	16.0	12.0	3.0	6.0	12.0~13.0		
SR6-18	18.5	12.0	3.0	6.0	14.0~15.0		
SR6-20	20.0	12.0	3.0	6.0	16.0~17.0		

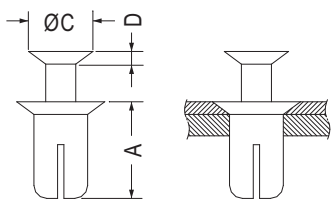

MOUNTING HOLE: ØG
THICKNESS: T

Part No.	A	C	D	G	T	Package
SR3-4.7F	4.7	5.75	0.8	3.0	1.5~2.0	1000
SR3-13F	14.3	5.3	1.3	3.3	10.0~11.0	
SR4-5.5F	5.5	5.8	0.7	4.0	2.0~3.0	
SR4-6F	6.1	7.5	1.1	4.0	3.0~4.0	
SR4-7F	7.2	7.5	1.1	4.0	3.5~5.0	
SR4-7FS	7.0	6.4	0.8	4.0	3.5~5.0	
SR4-8F	8.2	7.5	1.1	4.0	5.5~6.5	
SR4-10F	10.0	6.8	1.5	4.0	7.5~8.5	
SR4-13F	14.5	6.4	1.0	4.0	10.0~11.0	
SR5-4.5F	7.0	8.5	2.5	5.0	3.5~4.5	

尼龍鉚釘 SNAP RIVET

用途：用於風扇之固定。



- Material: Nylon 66 (UL)
- Flame Class: 94V-2/94V-0
- Color: Natural/Black
- Unit: mm

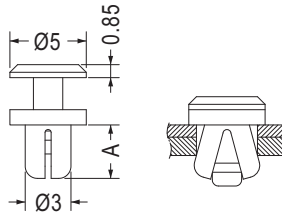

MOUNTING HOLE Ø3.0
THICKNESS: T

Part No.	A	T	Package
SRFA3-3.5	3.5	1.0~2.0	1000
SRFA3-4	4.0	1.5~2.5	

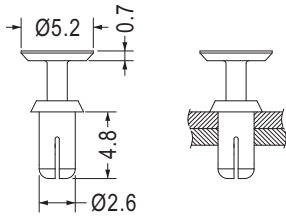

MOUNTING HOLE Ø2.6~Ø2.7
THICKNESS 2.5~3.4

Part No.	Package
SRE2.6-4.8	1000

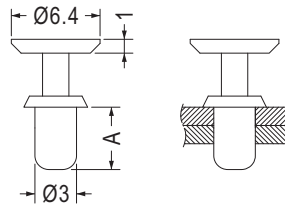

MOUNTING HOLE Ø3.1~Ø3.2
THICKNESS: T

Part No.	A	T	Package
SRE3-4.5	4.5	2.0~3.0	1000
SRE3-5.5	5.5	3.0~4.0	

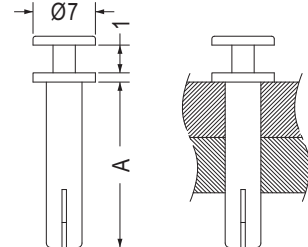

MOUNTING HOLE Ø4.0
THICKNESS: T

Part No.	A	T	Package
SRF4-28	28.0	25.0	500
SRF4-30	30.0	25.0	
SRF4-31	31.0	27.0	

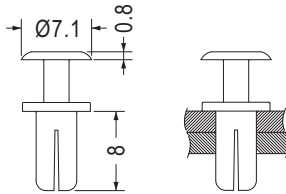

MOUNTING HOLE Ø4.2
THICKNESS 5.5~6.5

Part No.	Package
SRF4-8	1000

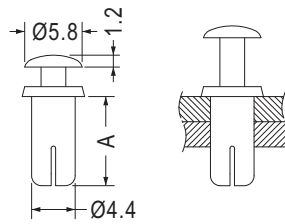

MOUNTING HOLE Ø4.5
THICKNESS: T

Part No.	A	T	Package
SRR4.5-8	8.0	4.2	1000
SRR4.5-9	9.0	5.2	
SRR4.5-10	10.0	6.2	
SRR4.5-12	12.0	8.2	
SRR4.5-14	14.0	10.2	
SRR4.5-16	16.0	12.2	



- Material: Nylon 66 (UL)
- Flame Class: 94V-2/94V-0
- Color: Black
- Unit: mm

用途：用於PC板與機板間固定，省時方便。

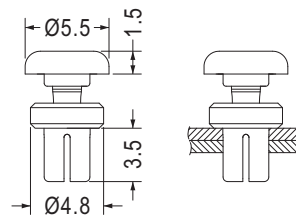

MOUNTING HOLE Ø3.0
THICKNESS 1.6

Part No.	Package
ULCZ-1.6	1000

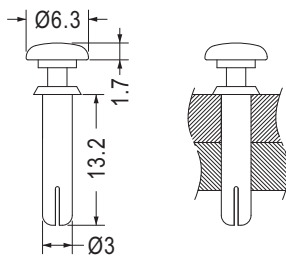

MOUNTING HOLE Ø3.0
THICKNESS 10.0~11.0

Part No.	Package
SRS3-13P	1000

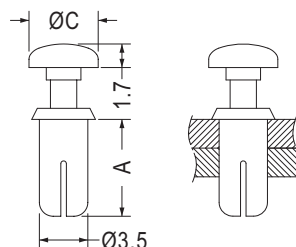

MOUNTING HOLE: ØG
THICKNESS: T

Part No.	A	C	G	T	Package
SRS3.5-4.5P	4.5	6.3	3.5	1.5~3.0	1000
SRS3.5-7P	7.0	5.0	3.5~3.6	4.5~5.5	

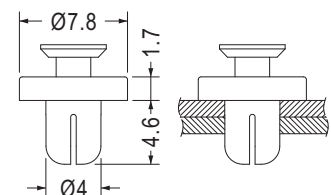

MOUNTING HOLE Ø4.0
THICKNESS 1.8~2.5

Part No.	Package
SRF4-4.6F	1000

尼龍鉚釘 SNAP RIVET

用途：用於PC板與機板間固定，省時方便。



- Material: Nylon 66 (UL)
- Flame Class: 94V-2/94V-0
- Color: Black
- Unit: mm

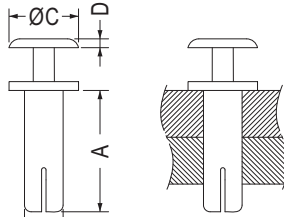

MOUNTING HOLE Ø3.5
THICKNESS: T

Part No.	A	B	C	D	T	Package
SRF3.5-11	11.0	3.5	6.3	0.8	8.0	1000
SRF3.5-29	29.0	3.4	6.3	0.8	25.0	
SRF3.5-37	37.0	3.4	6.3	0.8	34.0	
SRF3.5-61.5	61.5	3.4	5.3	0.5	59.0	500
SRF3.5-62	62.3	3.4	6.3	0.8	58.0	
SRF3.5-65	65.0	3.4	6.3	0.8	62.0	



- Material: Nylon 66 (UL)
- Flame Class: 94V-2/94V-0
- Color: Natural/Black
- Unit: mm

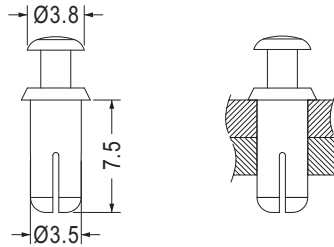

MOUNTING HOLE Ø3.5
THICKNESS 5.0~6.0

Part No.	Package
SRR3.5-7.5	1000

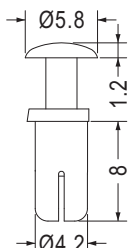

MOUNTING HOLE Ø4.3~Ø4.4
THICKNESS 4.5

Part No.	Package
SRH4.2-8	1000

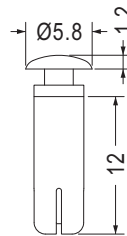

MOUNTING HOLE Ø4.5
THICKNESS 8.2
(RECOMMEND FOR REFERENCE ONLY)

Part No.	Package
★SRRH4.5-12	1000

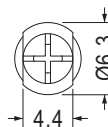
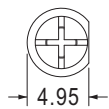

7



- Material: Nylon 66 (UL)
- Flame Class: 94V-2/94V-0
- Color: Natural/Black/Gray
- Unit: mm

用途：用於PC板與機板間固定，省時方便。

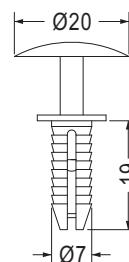

MOUNTING HOLE Ø7.0
THICKNESS 10.0

Part No.	Package
SRB-1	1000

固定扣 DOOR LATCH

用途：固定於兩片鐵板，一般用於機器
的門扣，拆卸方便。



- Clip Material: Nylon 66 (UL) 94V-2/
PC (UL) 94V-2
- Pin Material: Nylon 66 (UL) 94V-2
- DL-11 Material: Pom (UL) 94HB
- Color: Natural/Black
- Unit: mm

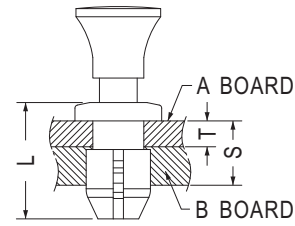

Plunger Head Style					
DL-1/DL-6	DL-2	DL-3/DL-4	DL-5	DL-7	DL-17

Part No.	L	S	T	Hole		Package
				A Board	B Board	
DL-1	11.1	2.0~4.2	1.6	Ø7.5	Ø8.0	500
DL-2	11.1	2.0~4.2	1.6	Ø7.5	Ø8.0	
DL-3	10.4	2.0~4.2	1.6	Ø6.0~Ø6.1	Ø6.4	
DL-4	11.4	3.0~5.2	2.5	Ø6.0~Ø6.1	Ø6.4	
DL-5	9.5	2.0~3.6	1.6	Ø4.5	Ø4.8	
DL-6	12.0	3.5	2.4	Ø6.6	Ø7.8	
DL-7	12.0	3.5	2.4	Ø6.6	Ø7.8	
DL-9	13.0	6.9	4.3	Ø6.0	Ø6.35	
DL-10	11.0	5.5	2.0	Ø6.0	Ø6.4~Ø6.5	
DL-11	10.5	2.1~4.35	1.0~1.65	Ø7.5~Ø7.6	Ø8.0~Ø8.2	
DL-14	11.0	5.5	2.0	Ø6.0	Ø6.4~Ø6.5	
DL-16	10.4	2.0~4.2	1.6	Ø6.0~Ø6.1	Ø6.4	
DL-17	12.67	2.0~3.6	1.6	Ø4.5	Ø4.8	

尼龍鉚釘 SNAP RIVET

用途：用於PC板與機板間固定，省時方
便。



- Material: Nylon 66 (UL)
- Flame Class: 94V-2/94V-0
- Color: Black
- Unit: mm

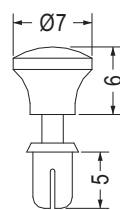

MOUNTING HOLE Ø3.5
THICKNESS 2.5~3.5

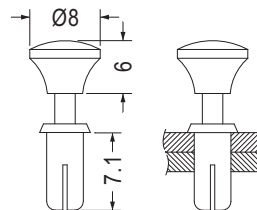

MOUNTING HOLE Ø4.1
THICKNESS 4.5~5.5

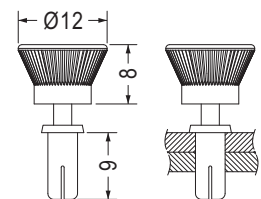

MOUNTING HOLE Ø4.1~Ø4.2
THICKNESS 6.5~7.5

Part No.	Package
SRS3.5-5P	1000

Part No.	Package
SRS4-7P	1000

Part No.	Package
SRS4-9K	1000

尼龍鉚釘 SNAP RIVET



- Material: Nylon 66 (UL)
- Pin Material: PC
- Flame Class: 94V-2/94V-0
- Color: Black
- Unit: mm

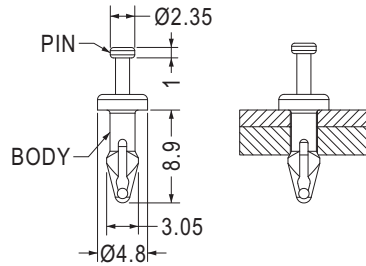

MOUNTING HOLE $\varnothing 2.5 \sim \varnothing 2.6$
THICKNESS 4.0~4.5

Part No.	Package
SRCC-16F	1000

用途：用於風扇之固定。

- Material: Nylon 66 (UL)
- Flame Class: 94V-2/94V-0

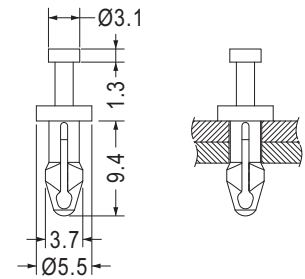

HOLE IN FAN $\varnothing 3.1 \sim \varnothing 3.3$
THICKNESS 3.9~4.6

Part No.	Package
SRCC-12F	1000

鉚釘 SNAP RIVET



- Material: TPE
- Pin Material: Nylon 66 (UL)
- Flame Class: 94V-2/94V-0
- Color: Black
- Unit: mm

HOLE IN FAN $\varnothing 3.6$
THICKNESS 0.8

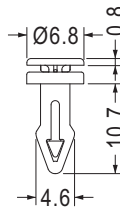

HOLE IN FAN $\varnothing 3.5$
THICKNESS 5.0

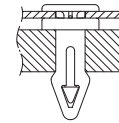

Part No.	Package
SRCC-13	1000

- Material: TPV (UL)
- Pin Material: Nylon 66 (UL)
- Flame Class: 94V-0

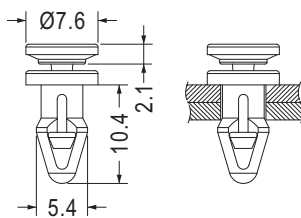

HOLE IN FAN $\varnothing 4.5$
THICKNESS 3.5

Part No.	Package
SRCC-11	1000

- Material: TPU
- Pin Material: Nylon 66 (UL)
- Flame Class: 94V-2

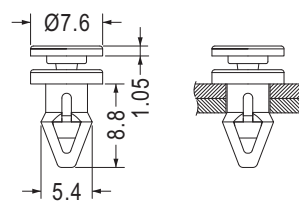

HOLE IN FAN $\varnothing 4.4$
THICKNESS 3.0

Part No.	Package
SRCC-9	1000

- Material: TPE(UL)
- Pin Material: Nylon 66 (UL)
- Flame Class: 94V-0

HOLE IN FAN $\varnothing 4.5$
THICKNESS 1.0~1.2

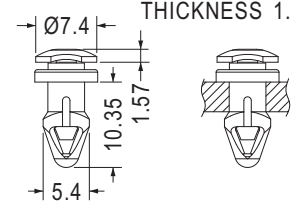

HOLE IN FAN $\varnothing 4.45$
THICKNESS 4.0

Part No.	Package
★SRCC-18	1000

尼龍鉚釘 SNAP RIVET



- Material: Nylon 66 (UL)
- Flame Class: 94V-2/94V-0
- Color: Natural/Black
- Unit: mm

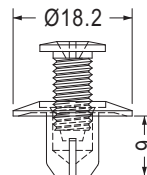

MOUNTING HOLE $\varnothing 8.0$
THICKNESS 3.5~4.2

Part No.	Package
PR-1	500

用途：用於PC板、鐵板零件固定，結合力量。

尼龍鉚釘 SNAP RIVET

用途：用於CPU座或散熱風扇與主機板之固定。



- Material: Nylon 66 (UL)
- Flame Class: 94V-2/94V-0
- Color: Natural/Black
- Unit: mm

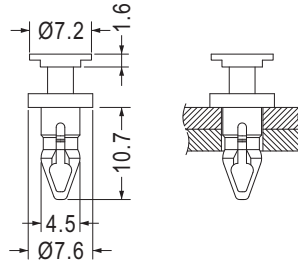

MOUNTING HOLE Ø4.6
THICKNESS 4.8

Part No.	Package
SRCC-4F	1000

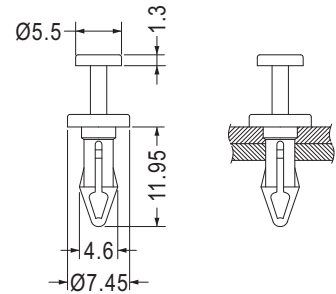

MOUNTING HOLE Ø4.1
THICKNESS 4.8

Part No.	Package
SRCC-5	1000

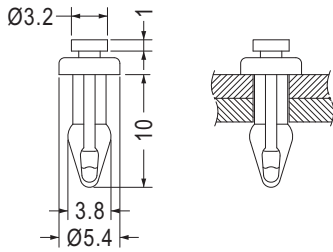

MOUNTING HOLE Ø3.0
THICKNESS 4.4

Part No.	Package
SRCC-7	1000

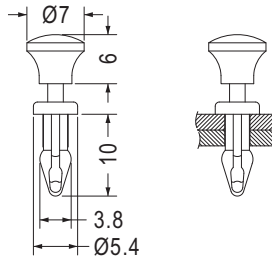

MOUNTING HOLE Ø3.0
THICKNESS 4.4

Part No.	Package
SRCC-7-1F	1000

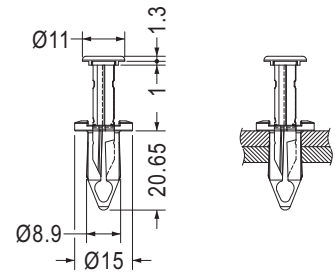

MOUNTING HOLE Ø8.0~Ø8.3
THICKNESS 3.0~8.0

Part No.	Package
SRCC-14	500



- Material: Nylon 66 (UL)
- Flame Class: 94V-2/94V-0
- Color: Natural/Black
- Unit: mm

用途：用於PC板與機板間固定，省時方便。

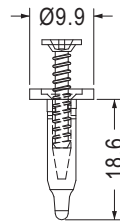

MOUNTING HOLE Ø4.5~Ø4.7
THICKNESS 8.3~10.0

Part No.	Package
PR-2	1000

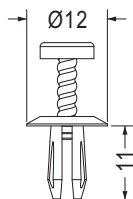

MOUNTING HOLE Ø5.0
THICKNESS 2.5~6.0

Part No.	Package
PR-5	1000

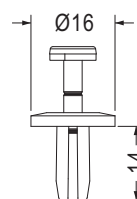

MOUNTING HOLE Ø7.0
THICKNESS 6.0

Part No.	Package
PR-6	1000

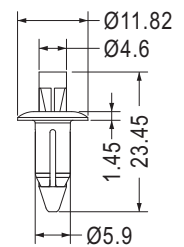

MOUNTING HOLE Ø6.3
THICKNESS 7.0

• Material: POM

Part No.	Package
PR-7	1000

尼龍鉚釘 SNAP RIVET

用途：用於PC板與機板間固定，省時方便。



- Material: PC (UL)
- Flame Class: 94V-0
- Color: White/Black
- Unit: mm

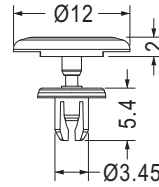

MOUNTING HOLE Ø3.5
THICKNESS 1.6~2.4

Part No.	Package
SRU3.5-4.5	1000

鉚釘 SNAP RIVET

用途：用於PC板、鐵板零件固定，結合力強。



- Material: POM
- Color: Black
- Unit: mm

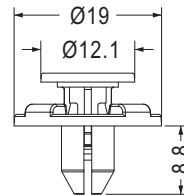

MOUNTING HOLE Ø7.0
THICKNESS 3.2~3.8

Part No.	Package
DLB-1	1000



- Material: PC (UL)
- Flame Class: 94V-0
- Color: Natural
- Patented (專利品)

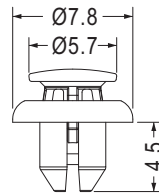

RECOMMEND MOUNTING HOLE Ø4.4~Ø4.5
RECOMMEND THICKNESS 1.0~1.2

Part No.	Package
DLB-2	1000

尼龍鉚釘 SNAP RIVET

用途：用於車用板件或板件間之固定，使用方便。



- Material: Nylon 66 (UL)
- Flame Class: 94V-2/94V-0
- Color: Natural/Black
- Unit: mm

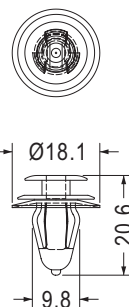

MOUNTING HOLE Ø8.0
THICKNESS 0.8~1.6

Part No.	Package
CAPR-10	500

尼龍鉚釘 SNAP RIVET

用途：用於裝配的孔或機板間之固定，敲入後可牢固於物件上。



- Material: Nylon 66 (UL)
- Flame Class: 94V-2/94V-0
- Color: Natural/Black
- Unit: mm

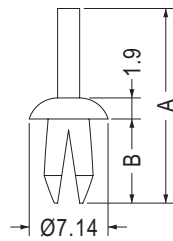

MOUNTING HOLE: ØG
THICKNESS: T

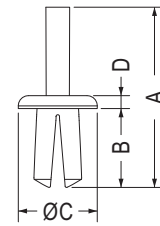

MOUNTING HOLE: ØG
THICKNESS: T

- Material: Nylon 66 (UL)/PP
- Flame Class: 94V-2/94V-0
- Color: Natural/Black/Gray

Part No.	A	B	G	T	Package
PSR-1	17.62	7.62	4.0	1.57~5.0	1000
PSR-2	16.1	7.4	4.8	1.57~5.53	

Part No.	A	B	C	D	G	T	Package
PSR-3	26.5	11.6	11.6	1.9	6.3	5.0	1000
PSR-4	17.8	7.9	8.7	2.0	4.8	4.0	

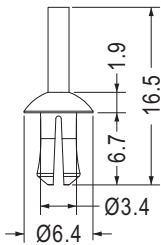

MOUNTING HOLE Ø3.4~Ø3.7
THICKNESS 3.4~4.8

Part No.	Package
PSR-6	1000

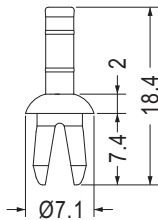

MOUNTING HOLE Ø5.0
THICKNESS 1.5~5.0

Part No.	Package
PSR-5	1000

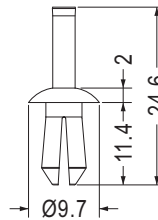

MOUNTING HOLE Ø5.0
THICKNESS 3.0~7.0

Part No.	Package
PSR-7	1000

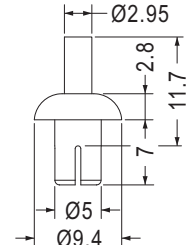

MOUNTING HOLE Ø5.1
THICKNESS 4.1~5.1

Part No.	Package
PSR5.1-7	1000

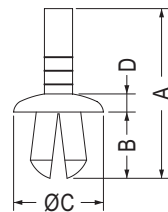

MOUNTING HOLE: ØG
THICKNESS: T

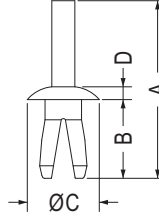

MOUNTING HOLE: ØG
THICKNESS: T

【 PSR-8 】

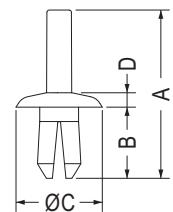

MOUNTING HOLE: ØG
THICKNESS: T

【 PSR5.5-10S 】

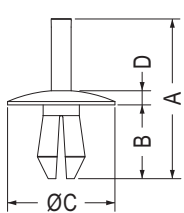

MOUNTING HOLE: ØG
THICKNESS: T

【 PSR5.5-11 】

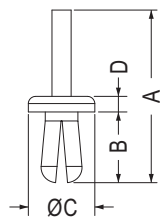

MOUNTING HOLE: ØG
THICKNESS: T

【 PSR5.5-11.5 】

Part No.	A	B	C	D	G	T	Package
PSR-8	18.0	8.2	7.5	1.3	4.0~4.2	4.0~6.5	1000
PSR5-7	18.7	7.3	9.9	2.0	5.2	2.0	
PSR5.5-10S	23.4	9.9	12.0	2.0	5.5	7.0	
PSR5.5-10	26.7	10.0	14.6	3.8	5.7~6.0	7.0	
PSR5.5-11	23.8	11.0	16.0	2.0	5.5~6.4	2.5~6.5	
PSR5.5-11.5	28.8	11.8	11.1	2.6	5.5	2.4~7.9	
PSR5.5-15	36.5	14.9	14.6	3.8	6.0	10.0	

尼龍鉚釘 SNAP RIVET

用途：用於裝配的孔或機板間之固定，敲入後可牢固於物件上。



- Material: Nylon 6 (UL)
- Flame Class: 94V-2
- Color: Natural/Black
- Unit: mm

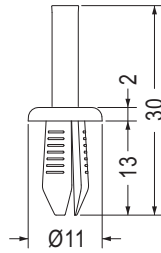

MOUNTING HOLE Ø6.0~Ø6.4
THICKNESS 6.0

Part No.	Package
PSR6-1	1000

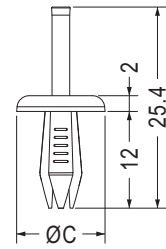

MOUNTING HOLE Ø4.0
THICKNESS 5.0

- Color: Blue

Part No.	C	Package
PSR4-12	9.0	1000
PSR4-12L	11.0	

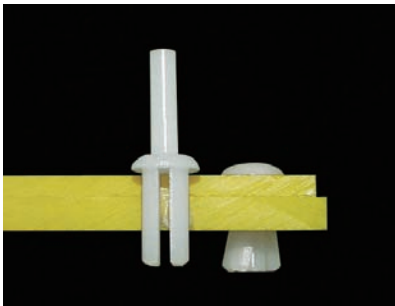

- Material: Nylon 66 (UL)
- Flame Class: 94V-2/94V-0
- Color: Natural/White/Black
- Unit: mm

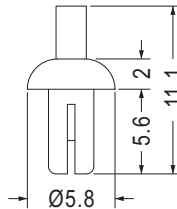

MOUNTING HOLE Ø3.0
THICKNESS 3.0

Part No.	Package
PSR3-5.5	1000

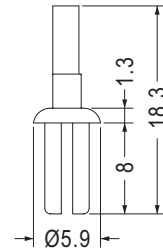

MOUNTING HOLE Ø4.0
THICKNESS 4.0

Part No.	Package
PSR4-8	1000

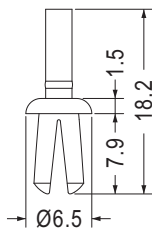

MOUNTING HOLE Ø4.0
THICKNESS 1.5~6.0

Part No.	Package
PSR4-7.5	1000

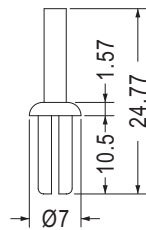

MOUNTING HOLE Ø4.6~Ø4.8
THICKNESS 6.5

Part No.	Package
PSR48-10	1000

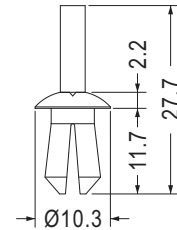

MOUNTING HOLE Ø6.0
THICKNESS 6.0

Part No.	Package
PSR6-11	1000

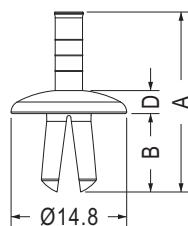

MOUNTING HOLE: ØG
THICKNESS: T

Part No.	A	B	D	G	T	Package
PSR6-10	23.0	10.0	2.95	6.0	2.0~7.0	1000
PSR6-15	36.8	15.0	3.8	6.35	6.0	

- Material: PE
- Color: Gray

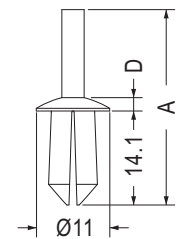

MOUNTING HOLE Ø7.0
THICKNESS 7.0

Part No.	A	D	Package
PSR6-14	29.3	2.0	1000
PSR6-14L	30.3	3.0	

尼龍鉚釘 SNAP RIVET

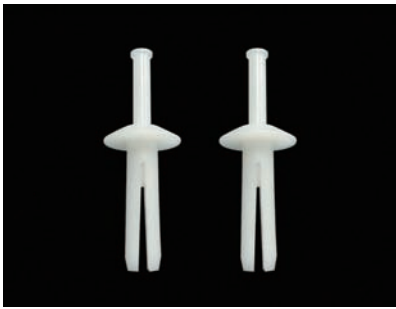

- Material: Nylon 66 (UL)
- Flame Class: 94V-2/94V-0
- Color: Natural/Black
- Unit: mm

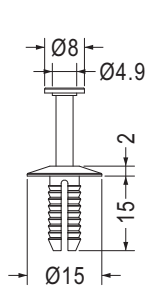

MOUNTING HOLE Ø6.35

Part No.	Package
PSRB-1	1000

用途：用於裝配的孔或機板間之固定，敲入後可牢固於物件上。

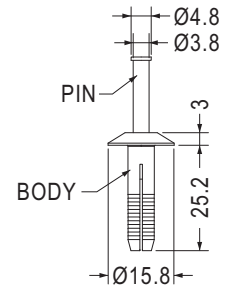

MOUNTING HOLE Ø6.4

Part No.	Package
PSR64-25	1000

尼龍鉚釘 MOUNTING BUTTON

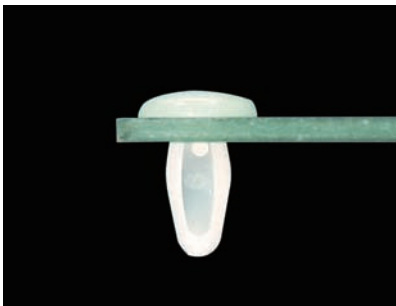

- Material: POM (UL)/Nylon 66 (UL)
- Flame Class: 94HB/94V-2/94V-0
- Color: Natural/Black
- Unit: mm

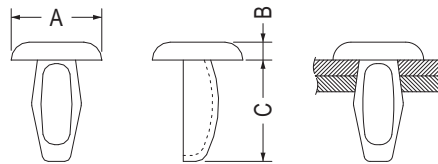

MOUNTING HOLE: G
BOARD THICKNESS: T

Part No.	A	B	C	G	T	Package
MB-1	7.6	1.6	8.6	3.3~3.5	2.0~3.1	2000
MB-2	7.6	1.3	10.8	3.3~3.6	3.0~4.0	1000
MB-3	7.3	1.4	8.4	3.0~3.2	2.0~3.5	2000

用途：用於PC板與機板間固定，省時方便。



- Material: Nylon 66 (UL)
- Flame Class: 94V-2/94V-0
- Color: Natural/Black
- Unit: mm

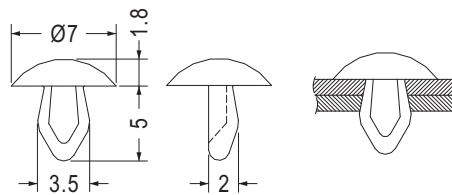

MOUNTING HOLE Ø3.15~Ø3.2
THICKNESS 1.6~1.9

Part No.	Package
MB-4	2000

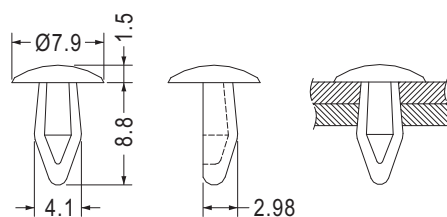

MOUNTING HOLE Ø3.5~Ø3.7
THICKNESS 3.5~4.0

Part No.	Package
MB-5	2000

尼龍鉚釘 MOUNTING BUTTON

用途：用於PC板與機板間固定，省時方便。

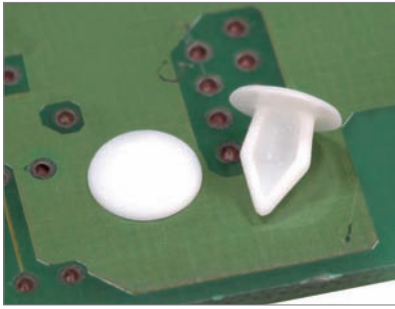

- Material: Nylon 66 (UL)
- Flame Class: 94V-2/94V-0
- Color: Natural/Black
- Unit: mm

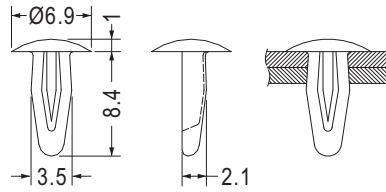

MOUNTING HOLE Ø3.1~Ø3.2
THICKNESS 2.0~2.5

Part No.	Package
MB-6	2000

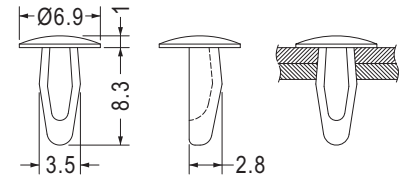

MOUNTING HOLE Ø3.1~Ø3.2
THICKNESS 2.0~2.5

Part No.	Package
MB-7	2000

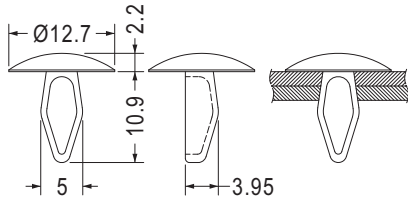

MOUNTING HOLE Ø4.0
THICKNESS 2.5~3.5

Part No.	Package
MB-18	1000

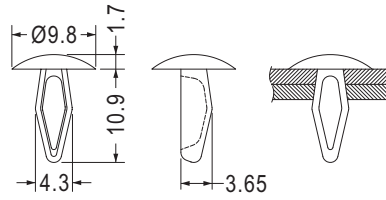

MOUNTING HOLE Ø3.9~Ø4.05
THICKNESS 2.1~3.7

Part No.	Package
MB-19	1000

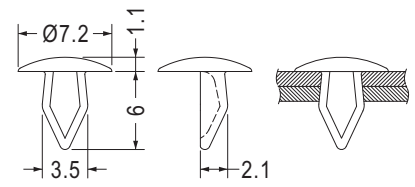

MOUNTING HOLE Ø3.0~Ø3.2
THICKNESS 0.8~2.0

Part No.	Package
MB-27	1000

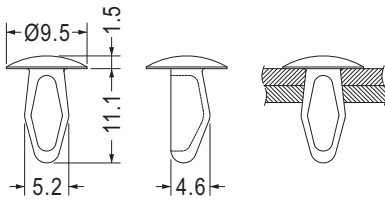

MOUNTING HOLE Ø4.7~Ø4.8
THICKNESS 2.5~4.0

Part No.	Package
MB-36	2000

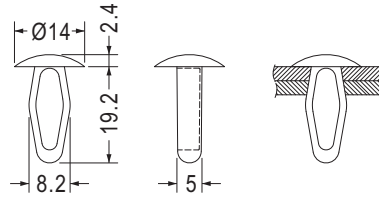

MOUNTING HOLE Ø6.4
THICKNESS 5.0

Part No.	Package
MB-39	1000

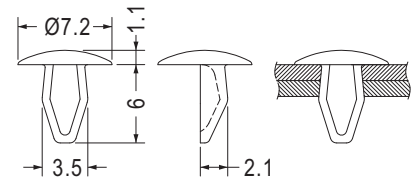

MOUNTING HOLE Ø3.0~Ø3.2
THICKNESS 0.8~2.0

Part No.	Package
MB-43	2000

- Material: PC+ABS (UL)
- Flame Class: 94V-0

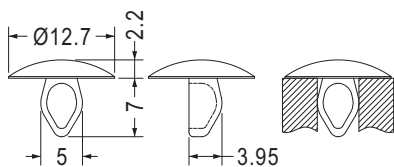

MOUNTING HOLE Ø4.8
THICKNESS 2.5

Part No.	Package
MB-52	2000

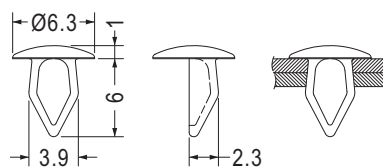

MOUNTING HOLE Ø3.5
THICKNESS 0.8~2.0

Part No.	Package
MB-55	2000

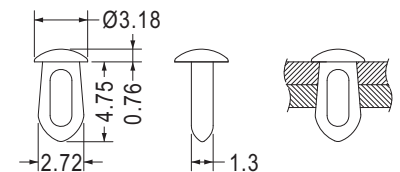

MOUNTING HOLE Ø2.16~Ø2.29
THICKNESS 0.81~2.72

Part No.	Package
MB-56	1000

尼龍鉚釘 MOUNTING BUTTON

用途：用於PC板與機板間固定，省時方便。

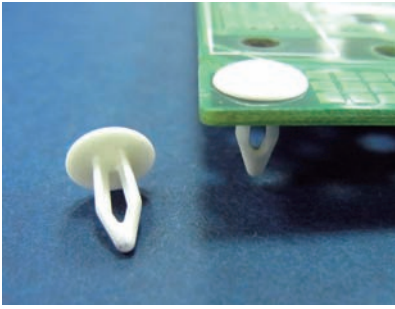

- Material: Nylon 66 (UL)
- Flame Class: 94V-2/94V-0
- Color: Natural/Black
- Unit: mm

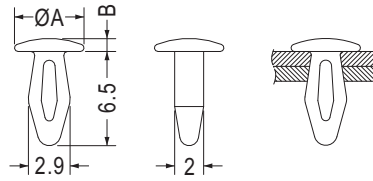

MOUNTING HOLE $\varnothing 2.5$
THICKNESS 2.0~2.5

Part No.	A	B	Package
MB-16	4.8	0.9	1000
MB-21	4.75	0.95	

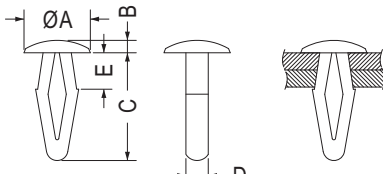

MOUNTING HOLE: $\varnothing G$
THICKNESS: T

- Material: Nylon 66 (UL)/POM (UL)
- Flame Class: 94HB/94V-2/94V-0

Part No.	A	B	C	D	E	G	T	Package
MB-23	9.0	1.6	14.0	2.9	5.0	3.9	1.0~5.0	1000
MB-23L	9.0	1.6	14.0	2.9	6.1	3.9	1.0~6.0	
MB-28	8.0	1.5	13.0	2.7	4.4	3.2	1.0~4.5	2000
MB-58	7.6	1.4	11.5	2.6	6.5	3.2	3.5~6.3	

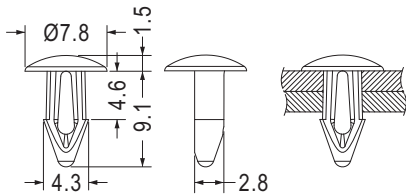

MOUNTING HOLE $\varnothing 3.6$

- Material: Nylon 66 (UL)/PBT (UL)
- Flame Class: 94V-2/94V-0

Part No.	Package
MB-34	2000

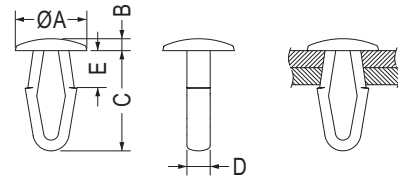

MOUNTING HOLE: $\varnothing G$
THICKNESS: T

- Material: Nylon 66 (UL)/POM (UL)
- Flame Class: 94HB/94V-2/94V-0

Part No.	A	B	C	D	E	G	T	Package
MB-30	12.0	2.0	16.8	3.9	6.2	6.4	1.5~6.2	2000
MB-48	11.0	2.9	15.0	3.4	5.7	4.7	1.0~5.5	

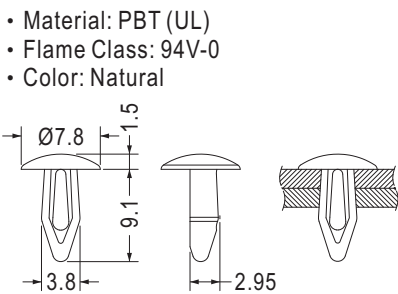

MOUNTING HOLE $\varnothing 3.5$
THICKNESS 3.5~4.3

Part No.	Package
MB-44	2000

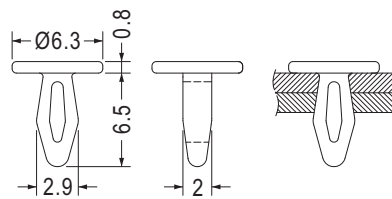

MOUNTING HOLE $\varnothing 2.5$
THICKNESS 2.0~2.5

Part No.	Package
MB-50	2000

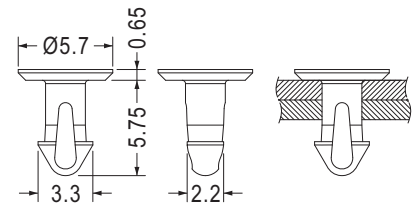

MOUNTING HOLE $\varnothing 2.5$
THICKNESS 3.5

Part No.	Package
MB-60	2000

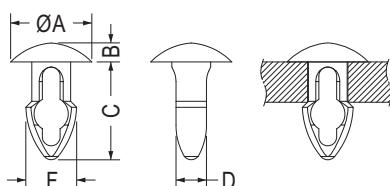

MOUNTING HOLE: $\varnothing G$
THICKNESS: T

Part No.	A	B	C	D	F	G	T	Package
MB-57	6.4	1.5	7.7	2.4	4.0	3.17	3.17	2000
MB-59	7.93	1.57	9.53	2.6	5.1	4.0	4.0	
MB-61	6.35	1.57	6.95	2.45	4.2	3.17	2.36	
MB-62	6.35	1.57	8.6	2.5	4.2	3.17	4.0	
MB-64	8.0	1.57	10.43	4.4	6.05	4.75	3.18	
MB-65	8.0	1.57	11.63	4.4	6.05	4.75	4.75	
MB-66	8.0	1.57	13.43	4.4	6.05	4.75	6.35	

尼龍鉚釘 MOUNTING BUTTON

用途：用於各種零件間之固定，省時方便。



- Material: Nylon 66 (UL)/POM (UL)
- Flame Class: 94HB/94V-2/94V-0
- Color: White/Black
- Unit: mm

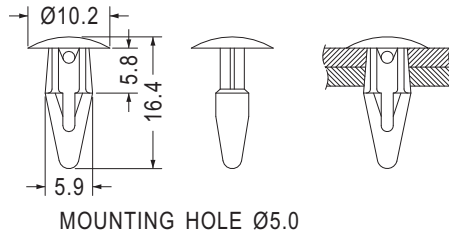

Part No.	Package
MBT-1	1000



- Material: Nylon 66 (UL)
- Flame Class: 94V-2/94V-0
- Color: Natural/Black
- Unit: mm

用途：用於PC板與機板間固定，省時方便。

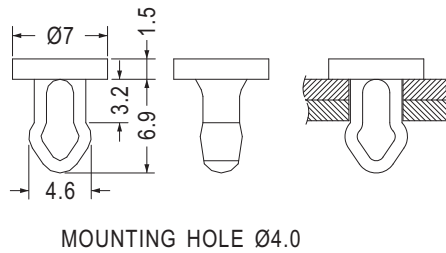

Part No.	Package
MBT-2	2000

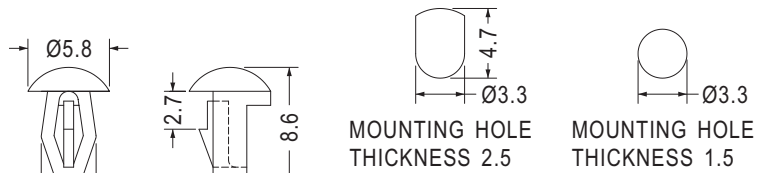

Part No.	Package
MBS3-3	2000

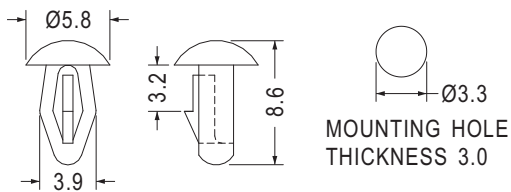

Part No.	Package
MBS3-3	2000

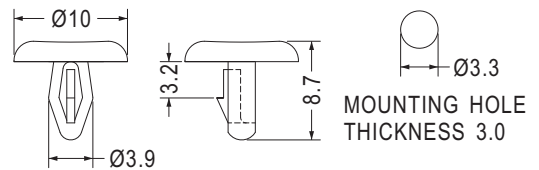

Part No.	Package
MBS3-4	1000



- Material: Nylon 66 (UL)
- Flame Class: 94V-2/94V-0
- Color: Natural/Black
- Unit: mm

用途：裝於機殼上，避免使用者不當自行拆機。

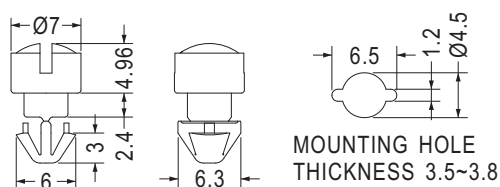

Part No.	Package
LEFS-2	1000

尼龍鉚釘 MOUNTING BUTTON

用途：用於PC板與機板間固定，省時方便。



- Material: Nylon 66 (UL)
- Flame Class: 94V-2/94V-0
- Color: Natural/Black
- Unit: mm

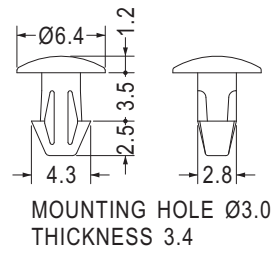

Part No.	Package
HSR-8A	1000

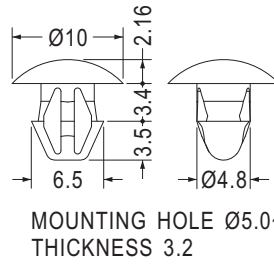
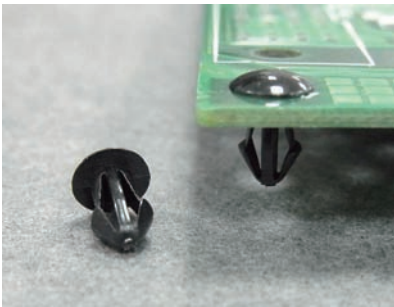

Part No.	Package
HSRA-1	1000

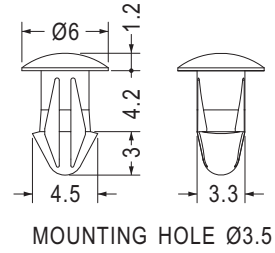

Part No.	Package
MB-33	1000

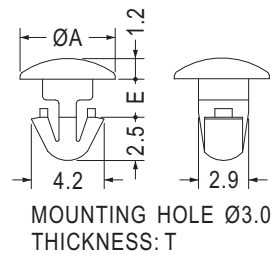
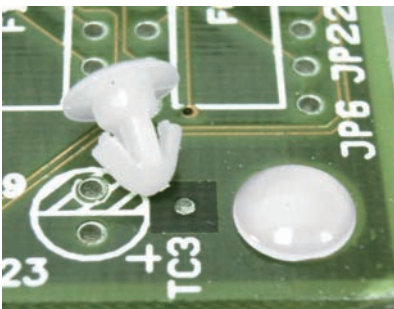

Part No.	A	E	T	Package
MBL3-2	5.5	2.2	2.0	2000
MBL3-2.5	6.4	2.5	2.4	
MBL3-3	6.4	3.0	2.8	
MBL3-3.5	5.5	3.7	3.5	

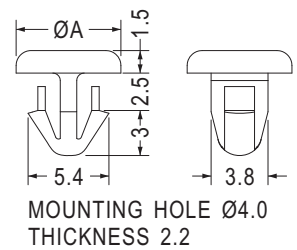

Part No.	A	Package
MB-32	7.0	1000
MB-53	8.0	



- Material: Nylon 66 (UL)
- Flame Class: 94V-2/94V-0
- Color: Natural/Black
- Unit: mm

用途：裝於機殼上，避免使用者不當自行拆機。

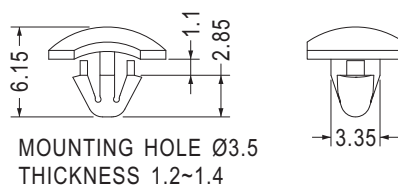
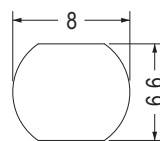

Part No.	Package
MB-45	1000

尼龍鉚釘 MOUNTING BUTTON

用途：用於PC板與機板間固定，省時方便。



- Material: Nylon 66 (UL)
- Flame Class: 94V-2/94V-0
- Color: Natural/Black
- Unit: mm

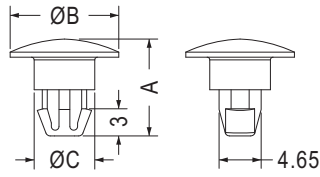

MOUNTING HOLE Ø4.8
THICKNESS: T

Part No.	A	B	C	T	Package
MBL4.8-2	10.7	12.0	6.7	2.0	1000
MBL4.8-2-4	11.1	12.0	6.7	2.0	
MBL4.8-2.4	11.2	12.0	6.7	2.4	
MBL4.8-3	11.1	10.0	7.3	2.0	
MBL4.8-4	12.8	12.0	6.7	4.0	

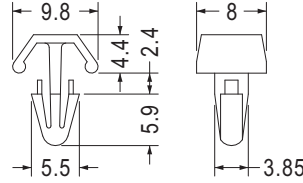
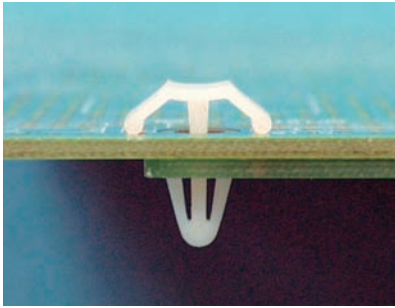

MOUNTING HOLE Ø4.0
THICKNESS 2.5~3.2

Part No.	Package
MB-10	1000

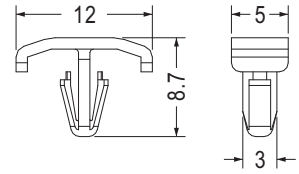

MOUNTING HOLE Ø3.2
THICKNESS 0.8~2.3

Part No.	Package
MB-12	1000

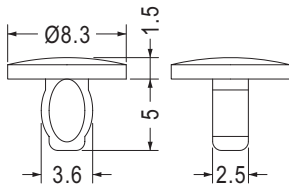

MOUNTING HOLE Ø3.0~Ø3.2
THICKNESS 1.8

Part No.	Package
MB-8	1000

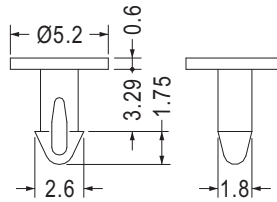

MOUNTING HOLE Ø2.0
THICKNESS 3.2

Part No.	Package
MB-14	2000

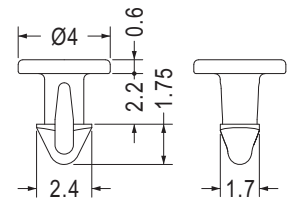

MOUNTING HOLE Ø2.0
THICKNESS 1.9

Part No.	Package
MB-63	2000

7

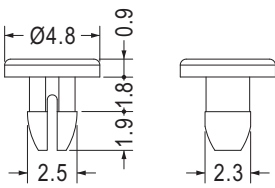

MOUNTING HOLE Ø2.3
THICKNESS 1.6

Part No.	Package
MBT2.3-1.6	2000

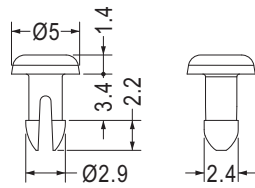

MOUNTING HOLE Ø2.5
THICKNESS 3.2

Part No.	Package
MBT2.5-3.2	2000

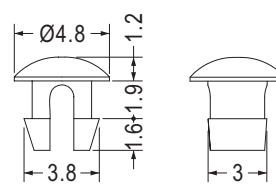

MOUNTING HOLE Ø3.0
THICKNESS 1.6~1.8

Part No.	Package
MBT3-2	2000

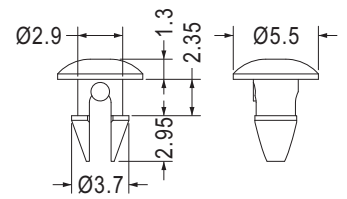

MOUNTING HOLE Ø3.0
THICKNESS 2.2

Part No.	Package
MBT-17	2000

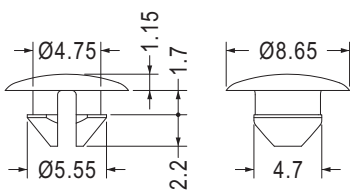

MOUNTING HOLE Ø4.8
THICKNESS 1.6

Part No.	Package
MBT-15	2000

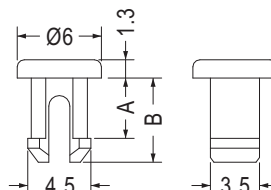

MOUNTING HOLE Ø4.0

Part No.	A	B	Package
MBT-7	4.3	6.0	2000
MBT4-2	2.0	3.7	

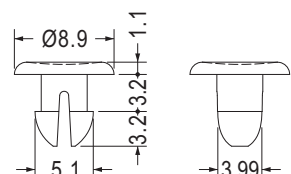

MOUNTING HOLE Ø4.5
THICKNESS 3.0

Part No.	Package
MBT-10	1000

鉚釘 MOUNTING BUTTON

用途：用於螺絲孔的塞頭。



- Material: PC+ABS (UL)
- Flame Class: 94V-2/94V-0
- Color: Black/Gray
- Unit: mm

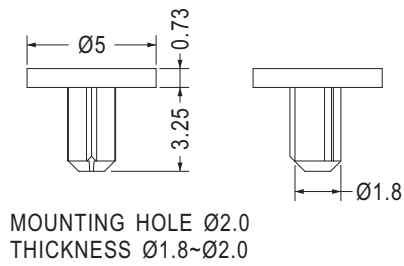

Part No.	Package
MB-20	2000



- Material: PC
- Color: Black
- Unit: mm

用途：用於PC板與機板間固定，省時方便。

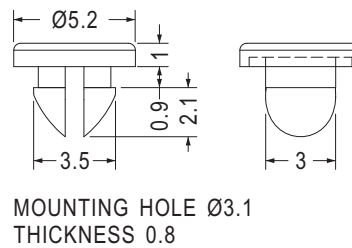

Part No.	Package
MBT3.1-0.8	2000

尼龍鉚釘 MOUNTING BUTTON

用途：用於PC板與機板間固定，省時方便。



- Material: Nylon 66 (UL)
- Flame Class: 94V-2/94V-0
- Color: Natural/Black
- Unit: mm

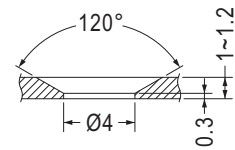
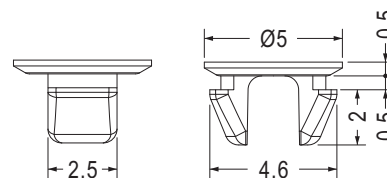

MOUNTING HOLE Ø4.0
CHASSIS THICKNESS 1.0~1.2

Part No.	Package
MBE4-1.2	1000

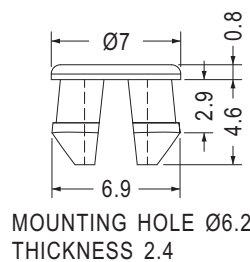

Part No.	Package
MBT6.2-3	2000

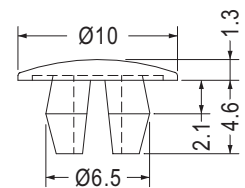

MOUNTING HOLE Ø6.0
THICKNESS 1.2

Part No.	Package
MBT6-2	2000



MOUNTING HOLE Ø6.35
THICKNESS 0.79~1.58

Part No.	Package
MBT-11	2000

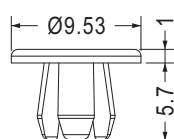

MOUNTING HOLE Ø4.8
THICKNESS 0.8~3.6

Part No.	Package
MBT-12	2000

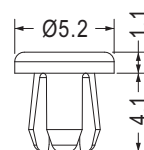

MOUNTING HOLE Ø3.2
THICKNESS 0.8~2.4

Part No.	Package
MBT-16	2000

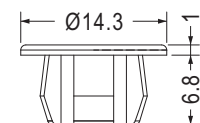

MOUNTING HOLE Ø9.5
THICKNESS 0.8~3.6

Part No.	Package
MBT-13	1000

尼龍鉚釘 SNAP RIVET

用途：用於PC板、鐵板、書本間固定，
結合力強，搭配BRR1-1使用。

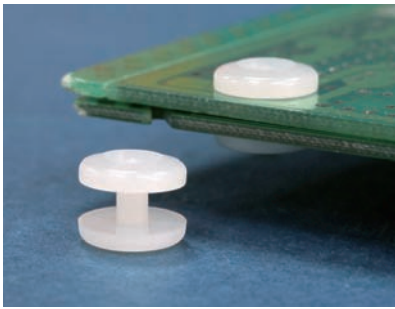

- Material: Nylon 66 (UL)
- Flame Class: 94V-2/94V-0
- Color: Natural/Black
- Unit: mm

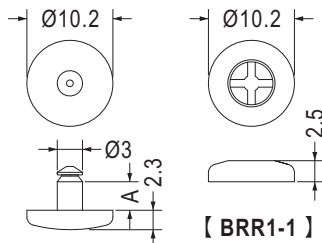

TO FIT IN Ø3.2 HOLE



Part No.	A	T	Package
BRP1-1.6	1.6	0.76	1000
BRP1-2.4	2.4	1.57	
BRP1-3.4	3.3	2.54	
BRP1-4	4.0	3.18	
BRP1-5.6	5.5	4.75	
BRP1-7.2	7.1	6.35	

THICKNESS: T
組裝示意圖



- Material: Nylon 66 (UL)
- Flame Class: 94V-2/94V-0
- Color: Natural/Black
- Unit: mm

用途：用於PC板與機板間固定，省時方便。

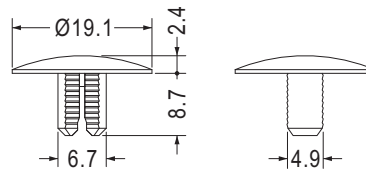

MOUNTING HOLE Ø7.1
ASSEMBLED THICKNESS 8.8~12.8

Part No.	Package
MBG2-8.7	1000

尼龍鉚釘 MOUNTING BUTTON

用途：用於木板、鐵板、PC板...等，板子間的結合固定。



- Material: Nylon 66 (UL)
- Flame Class: 94V-2/94V-0
- Color: Natural/Black
- Unit: mm

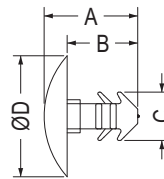

MOUNTING HOLE: ØG
THICKNESS: T

Part No.	A	B	C	D	G	T	Package
MBW-47	6.5	4.9	3.4	8.4	3.0	1.6~3.0	1000
MBW-60	6.9	5.3	3.7	8.7	3.2	1.6~3.2	2000

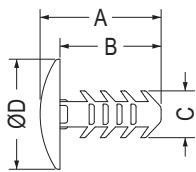

MOUNTING HOLE: ØG
THICKNESS: T

Part No.	A	B	C	D	G	T	Package
MBW-31	9.6	8.0	3.7	8.7	3.2	1.57~6.35	1000
MBW-32	12.5	10.0	7.0	17.8	6.35	1.57~6.35	
MBW-59	12.0	9.5	5.8	15.9	5.25	1.57~6.35	
MBW-62	9.2	7.6	3.4	8.4	3.0	1.6~6.0	
MBW-63	10.8	8.8	5.2	12.7	4.8	1.6~6.4	
MBW-65	13.8	11.3	10.3	25.4	9.5	1.6~6.4	
MBW-66	10.3	8.3	4.6	11.2	4.0	1.6~6.0	
MBW-68	11.3	9.3	6.4	16.8	6.0	1.6~6.0	

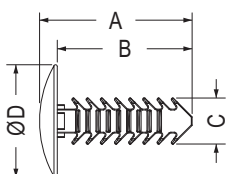

MOUNTING HOLE: ØG
THICKNESS: T

Part No.	A	B	C	D	G	T	Package
MBW-33	22.4	19.9	8.5	12.5	7.9	1.6~15.9	1000
MBW-43	22.4	19.7	5.8	22.4	7.9	1.6~15.9	
MBW-49	13.2	11.6	3.7	8.7	3.2	1.6~9.5	
MBW-50	17.2	15.2	5.2	12.7	4.8	1.6~12.7	
MBW-56	21.0	19.0	5.25	8.0	4.8	2.1~15.9	
MBW-58	20.0	17.5	10.2	25.4	9.5	1.6~12.7	2000
MBW-64	13.3	11.7	3.45	8.4	3.0	1.6~10.0	
MBW-67	14.3	12.3	5.3	14.0	5.0	1.6~10.0	1000
MBW-69	15.9	13.4	8.5	22.2	7.9	1.6~9.5	
MBW-70	15.6	13.1	7.8	20.0	7.1	1.6~9.5	
MBW-75	28.4	25.9	7.8	20.0	7.15	1.6~22.3	
★MBW-77	16.5	14.5	10.5	15.0	10.0	1.6~9.5	

尼龍鉚釘 MOUNTING BUTTON

用途：用於木板、鐵板、PC板...等，板子間的結合固定。



- Material: Nylon 6 (UL)/Nylon 66 (UL)
- Flame Class: 94V-2/94V-0
- Color: Natural/Black
- Unit: mm

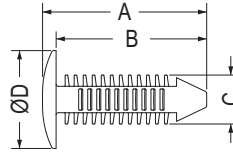

MOUNTING HOLE: ØG
THICKNESS: T

Part No.	A	B	C	D	G	T	Package
MBW-17	18.5	17.5	5.6	11.7	4.8	2.54~15.2	1000
MBW-23	21.5	20.5	5.6	11.7	4.8	4.0~25.0	
MBW-42S	12.3	11.0	3.3	6.0	2.7~3.3	1.5~8.0	
MBW-42	12.3	11.0	3.4	6.0	3.0~3.3	1.5~8.0	
MBW-73	19.2	18.0	3.3	6.0	2.7~3.3	1.5~15.0	
MBW-74	21.8	20.0	6.5	13.0	5.6~6.4	1.5~15.0	



- Material: Nylon 66 (UL)
- Flame Class: 94V-2/94V-0
- Color: Natural/Black
- Unit: mm

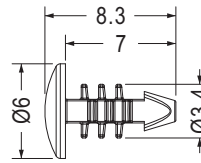

MOUNTING HOLE Ø2.7~3.3
THICKNESS 1.5~4.0



Part No.	Package
MBW-7S	2000

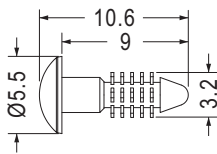

MOUNTING HOLE Ø3.0

Part No.	Package
MBW-9	1000

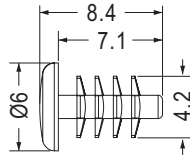

MOUNTING HOLE Ø3.5

Part No.	Package
MBW-7	1000

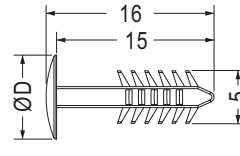

MOUNTING HOLE Ø4.0
THICKNESS 5.7~10.7

Part No.	D	Package
MBW-28	8.0	1000
MBW-28L	10.0	

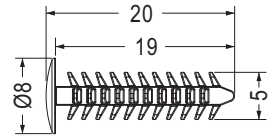

MOUNTING HOLE Ø4.0
THICKNESS 2.1~15.9

Part No.	Package
MBW-55	1000

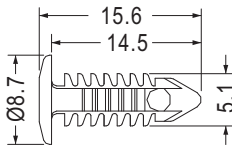

MOUNTING HOLE Ø4.5~Ø4.8

Part No.	Package
MBW-14	1000

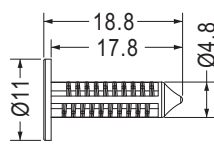

MOUNTING HOLE Ø5.0
THICKNESS 1.5~11.0

Part No.	Package
MBW-52	1000

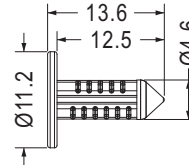

MOUNTING HOLE Ø5.0
THICKNESS 2.5~4.5

Part No.	Package
MBW-29	1000

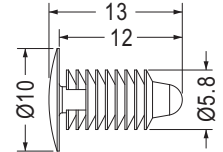

MOUNTING HOLE Ø5.5
THICKNESS 0.7~6.4

Part No.	Package
MBW5-12	1000

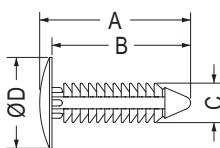

MOUNTING HOLE: ØG
THICKNESS: T

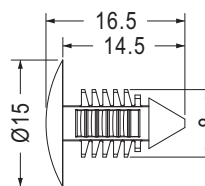

MOUNTING HOLE Ø7.0
THICKNESS 3.2~6.0

Part No.	Package
MBW-27	1000

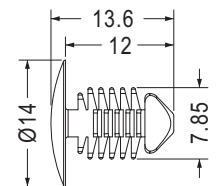

MOUNTING HOLE Ø7.0~Ø7.1
THICKNESS 3.0~7.0

Part No.	Package
MBW-71	1000

Part No.	A	B	C	D	G	T	Package
MBW-24	29.4	27.0	7.7	17.7	6.4~7.0	2.5~30.0	1000
MBW-51	22.9	20.4	7.7	17.8	6.0~6.3	2.5~12.0	
MBW-61	32.5	30.0	8.3	19.0	7.1	1.5~25.4	

尼龍鉚釘 MOUNTING BUTTON

用途：用於木板、鐵板、PC板...等，板子間的結合固定。



- Material: Nylon 66 (UL)
- Flame Class: 94V-2/94V-0
- Color: Natural/Black
- Unit: mm

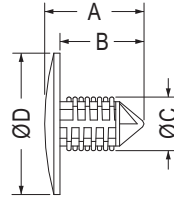

MOUNTING HOLE: ØG
THICKNESS: T

Part No.	A	B	C	D	G	T	Package
MBW6-11	13.0	11.0	7.4	18.5	6.35	0.8~7.4	1000
MBW7-20	23.0	20.0	7.86	25.4	7.0	2.54~20.0	

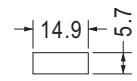
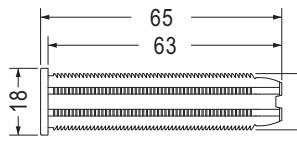

MOUNTING HOLE
THICKNESS 60.0

Part No.	Package
MBW-34	500

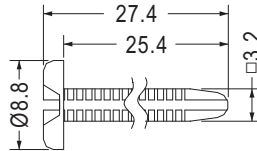
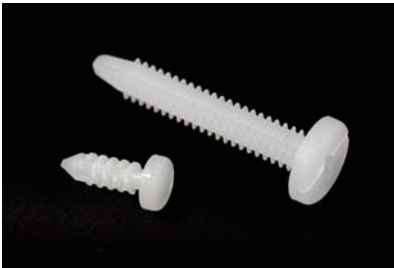

MOUNTING HOLE Ø3.0

Part No.	Package
MBW-18	1000

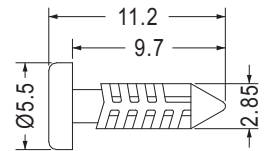

MOUNTING HOLE Ø3.0

Part No.	Package
MBW-21	1000



- Material: Nylon 66 (UL)
- Flame Class: 94V-2/94V-0
- Color: Natural/Black
- Unit: mm

用途：用於PC板與機板間固定，省時方便。

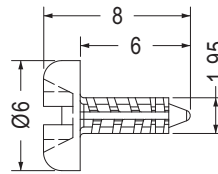

MOUNTING HOLE Ø2.2

Part No.	Package
MBW-36	2000

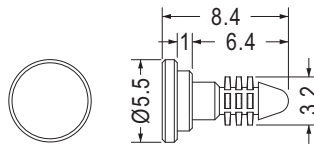

MOUNTING HOLE Ø3.0

Part No.	Package
MBW-38	2000

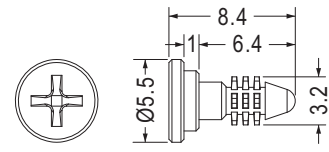

MOUNTING HOLE Ø3.0

Part No.	Package
MBW-40	2000



- Material: POM
- Color: White
- Unit: mm

用途：用於木板、鐵板、PC板...等，板子間的結合固定。

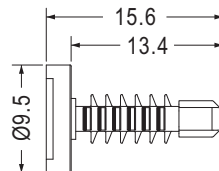

MOUNTING HOLE Ø3.96
THICKNESS 0.8~7.92

Part No.	Package
MBW-48	500

螺絲鉚釘 SCREW RIVET

用途：螺絲孔之保護。



- Material: Nylon 66 (UL)
- Flame Class: 94V-2/94V-0
- Color: Natural/Black
- Unit: mm

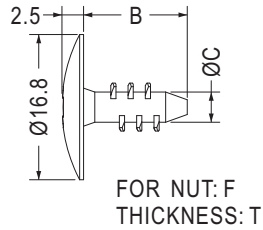

Part No.	B	C	F	T	Package
MBWC-1	12.0	3.5	M6	5.0	1000
MBWC-1-1	12.0	3.45	M6	5.0	
MBWC-4	18.0	3.45	M6	10.0	
MBWC-5	14.0	4.5	M8	5.0	

尼龍鉚釘 SNAP RIVET

用途：用於PC板、鐵板、書本間固定，可調式，結合力強，可搭配BRR1-1使用。



- Material: Nylon 66 (UL)
- Flame Class: 94V-2/94V-0
- Color: Natural/Black
- Unit: mm

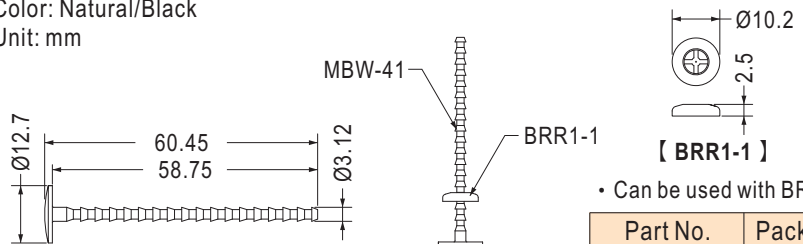

使用示意圖

Part No.	Package
MBW-41	500

散熱片鉚釘 SNAP RIVET

用途：將散熱片固定。



- Material: Nylon 66 (UL)
- Flame Class: 94V-2/94V-0
- Color: Natural/Black
- Unit: mm

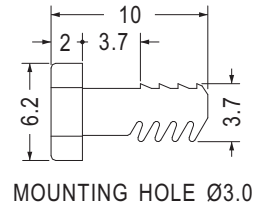

Part No.	Package
MBW3-8	1000

鉚釘 SNAP RIVET

用途：用於PC板與機板間固定，省時方便。



- Material: Nylon 66 (UL)
- Flame Class: 94V-2/94V-0
- Color: Natural/Black
- Unit: mm

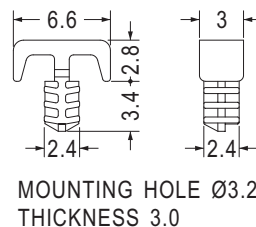

Part No.	Package
MBW-22	1000

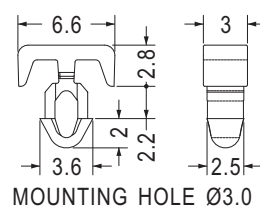

Part No.	Package
MBWB-1	1000

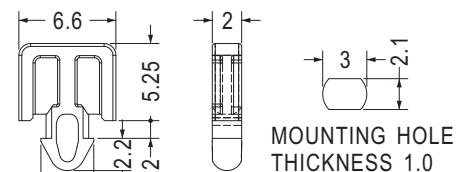

Part No.	Package
MBWB-2	1000

尼龍鉚釘 MOUNTING BUTTON

用途：用於電線固定。

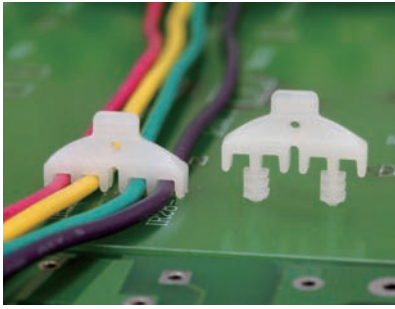

- Material: Nylon 66 (UL)
- Flame Class: 94V-2/94V-0
- Color: Natural/Black
- Unit: mm

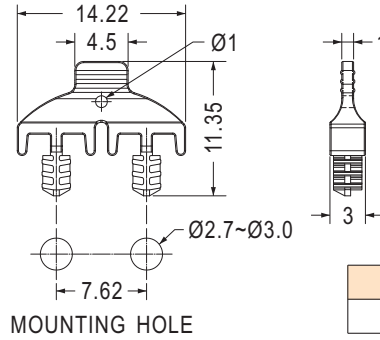

Part No.	Package
MBW-46	1000

塑膠鉚釘 MOUNTING BUTTON

用途：用於機板與機板間之固定，使用方便。

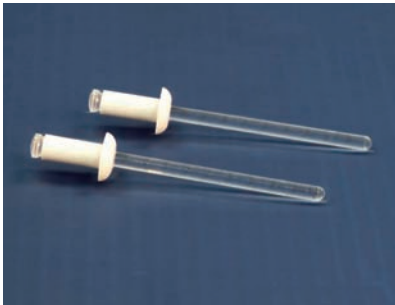

- Material: Nylon 66 (UL)/PC (UL)
- Flame Class: 94V-2/94V-0
- Color: Natural/Black
- Unit: mm

Part No.	A	B	C	D	E	F	G	T	Package
CR32-1	3.2	6.4	6.4	1.4	2.1	20.0	Ø3.3	1.0~4.0	500
CR32-2	3.2	9.6	6.4	1.4	2.1	20.0	Ø3.3	4.0~7.0	
CR32-3	3.2	12.7	6.4	1.4	2.1	20.0	Ø3.3	7.0~10.0	
CR40-1	4.0	6.4	8.0	1.8	2.4	25.0	Ø4.1	1.0~4.0	
CR40-2	4.0	9.6	8.0	1.8	2.4	25.0	Ø4.1	4.0~7.0	
CR40-3	4.0	12.7	8.0	1.8	2.4	25.0	Ø4.1	7.0~10.0	
CR48-1	4.8	8.0	9.6	2.0	2.8	40.0	Ø4.9	1.5~5.0	
CR48-2	4.8	11.2	9.6	2.0	2.8	40.0	Ø4.9	5.0~8.0	
CR48-3	4.8	14.4	9.6	2.0	2.8	40.0	Ø4.9	8.0~11.0	
CR56-1	5.6	9.6	12.0	2.2	3.4	65.0	Ø5.7	2.0~5.5	
CR56-2	5.6	12.7	12.0	2.2	3.4	65.0	Ø5.7	5.5~8.5	
CR56-3	5.6	15.9	12.0	2.2	3.4	65.0	Ø5.7	8.5~12.0	

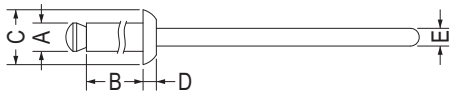

MOUNTING HOLE: ØG
THICKNESS: T
SHEAR FORCE: F (剪斷力) (kg)

尼龍鉚釘 SNAP RIVET

用途：用於兩片機板間之固定，配合拉釘工具使用。



- Clip Material: Nylon 66 (UL)
- Flame Class: 94V-2/94V-0
- Pin Material: POM
- Color: Black
- Unit: mm

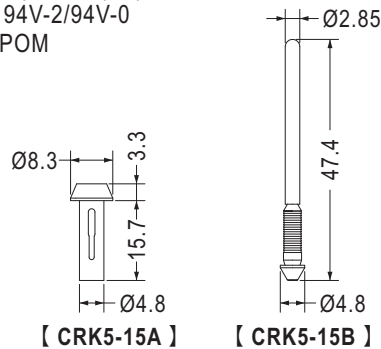

Part No.	組套件(ASSY)	Package
CRK5-15	CRK5-15A+CRK5-15B	500

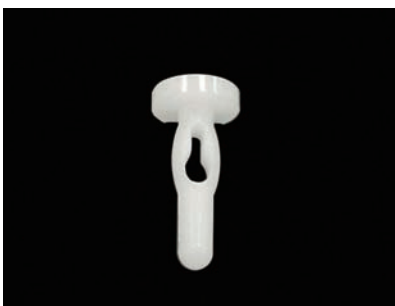

- Material: Nylon 66 (UL)
- Flame Class: 94V-2/94V-0
- Color: Natural/Black
- Unit: mm

用途：用於PC板與機板間固定，省時方便。

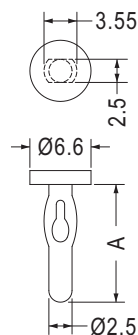

Part No.	A	Package
PIC-10	8.5	1000
PIC-14	12.7	

塑膠鉚釘 MOUNTING BUTTON

用途：用於機板間之固定，使用方便。



- Material: Nylon 66 (UL)
- Flame Class: 94V-2/94V-0
- Color: Natural/Black
- Unit: mm

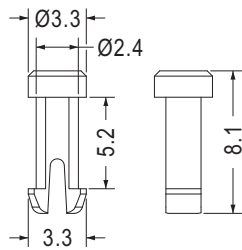

MOUNTING HOLE Ø2.5

Part No.	Package
PNLA-5.2	1000

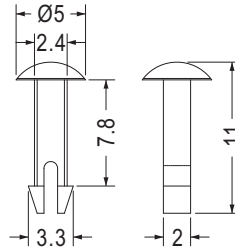

MOUNTING HOLE Ø2.5

Part No.	Package
PNL-7.8	1000

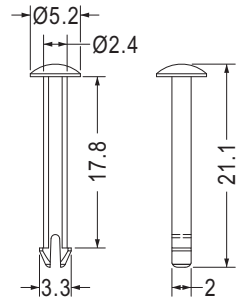

MOUNTING HOLE Ø2.5

Part No.	Package
PNL-17.8	1000

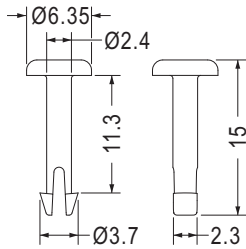

MOUNTING HOLE Ø2.5

Part No.	Package
PNLA-11.4	1000

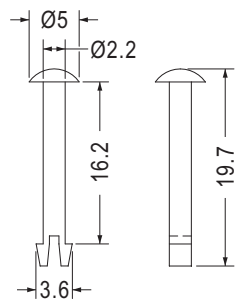

MOUNTING HOLE Ø3.0

Part No.	Package
PNL-18	1000

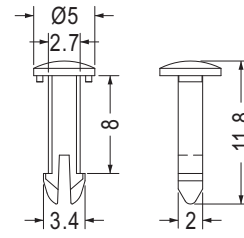

MOUNTING HOLE Ø3.0

Part No.	Package
PNL-8	1000

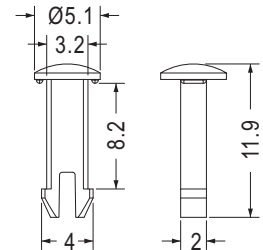

MOUNTING HOLE Ø3.3
THICKNESS 7.7

Part No.	Package
PNL-1	1000

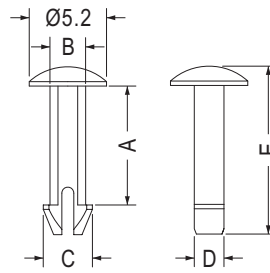

MOUNTING HOLE: ØG

Part No.	A	B	C	D	E	G	Package
PNLS-8	8.0	2.4	3.3	2.0	11.3	2.5	1000
PNLS-15	8.1	2.0	2.7	1.8	11.4	2.3	
PNLS-16	14.5	2.0	2.7	1.8	17.8	2.3	

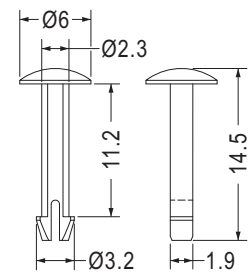

MOUNTING HOLE Ø2.4

- Material: LCP (UL)
- Flame Class: 94V-0
- Color: Natural

Part No.	Package
PNLSA-8	1000

插銷 PIN

用途：PC板與機板間固定，省時方便。



- Material: Nylon 66 (UL)
- Flame Class: 94V-2/94V-0
- Color: Natural/Black
- Unit: mm

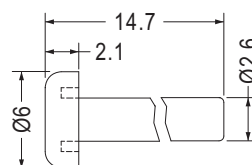

Part No.	Package
CNPS8000	1000

插銷 PIN

用途：配合超音波熱熔，可當螺絲固定。



- Material: ABS (UL)
- Flame Class: 94HB
- Color: Black
- Unit: mm

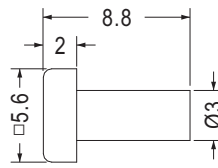

Part No.	Package
ACSR-7	2000



- Material: Nylon 66 (UL)
- Flame Class: 94V-2/94V-0
- Color: Natural/White/Black
- Unit: mm

用途：做為塑膠插銷pin使用。

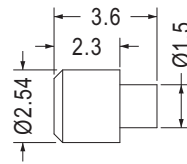

Part No.	Package
BPLTA-3	2000



- Material: PC (UL)
- Flame Class: 94V-2/94V-0
- Color: Transparent
- Unit: mm

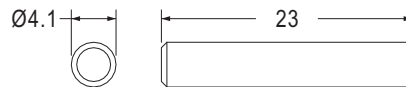

Part No.	Package
EM-579	1000



- Material: POM
- Color: Natural
- Unit: mm

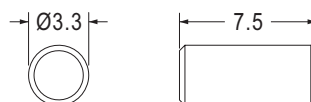

Part No.	Package
PIN3.3-7.5	2000



- Material: PC+ABS (UL)
- Flame Class: 94V-0
- Color: Natural
- Unit: mm

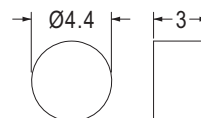

Part No.	Package
PIN4.4-3	2000

- Material: Nylon 66 (UL)
- Flame Class: 94V-2/94V-0
- Color: Natural
- Unit: mm

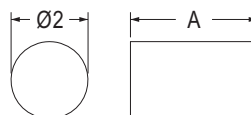

Part No.	A	Package
PIN2-3.3	3.3	2000
PIN2-3.6	3.6	

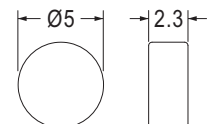

Part No.	Package
PIN5-2.3N	2000

風扇鉚釘 FAN MOUNT RIVET

用途：用於電腦電源風扇之固定，降低噪音、牢固。
G:為45度硬度，H:為55度硬度

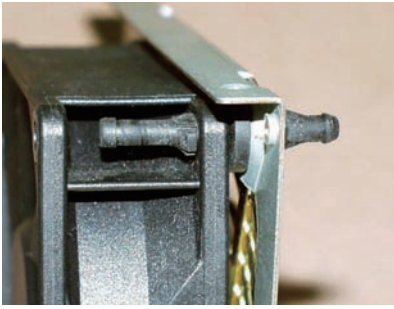

- Material: TPE/TPE (UL)
- G:Hardness is Shore A45
- H:Hardness is Shore A55
- Flame Class: 94V-0
- Color: Black
- Unit: mm

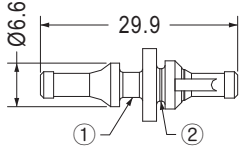

- ① Fan mounting hole $\text{Ø}4.5$ and thickness 3.0~5.5
- ② Support mounting hole $\text{Ø}5.0 \pm 0.1$ and thickness 1.0 ~2.0

Part No.	Package
BUB-30	1000

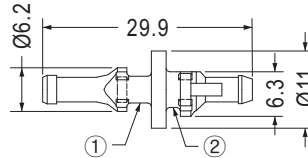

- ① Fan mounting hole $\text{Ø}4.5$ chassis thickness 3.5~4.0
- ② Support mounting hole $\text{Ø}4.5 \sim 4.8$ chassis thickness 0.8~2.0

Part No.	Package
BUB-29	1000

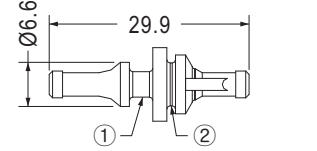

- ① Fan mounting hole $\text{Ø}4.6 \pm 0.2$ and thickness 3.0 ~5.5
- ② Support mounting hole $\text{Ø}6.5 \pm 0.1$ and thickness 1.0~2.0

Part No.	Package
BUB-30L	1000

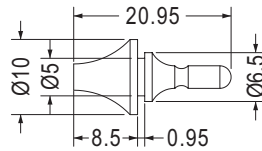

Part No.	Package
BUC-2	1000

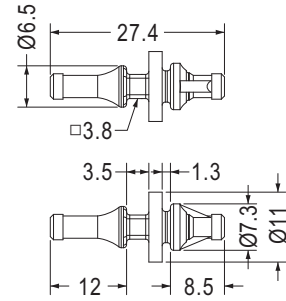

Part No.	Package
BUB-189	1000

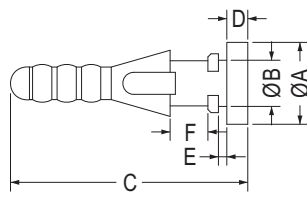
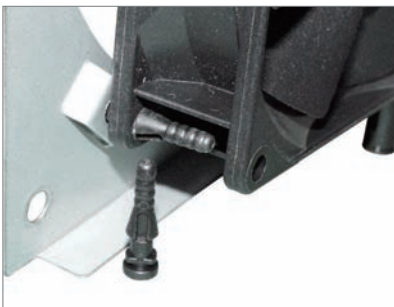

MOUNTING HOLE: ØG

• Color: Black/Blue

Part No.	A	B	C	D	E	F	G	Package
BUB-1	7.8	4.4	22.6	2.0	0.8	3.6	4.3	1000
BUB-5	10.25	4.4	23.0	1.6	1.3	3.0	4.4	
BUB-20	5.8	3.5	20.0	1.5	0.8	3.8	3.5	
BUB-22	7.8	4.4	23.1	2.5	0.8	3.6	4.4	
BUB-23	8.8	4.4	23.0	1.5	0.8	4.5	4.4	
BUB-25	7.8	4.4	23.7	2.5	1.4	3.6	4.4	
BUB-25.4	7.5	4.4	25.4	2.0	4.0	3.0	4.2	
BUB-70	5.8	3.5	70.0	1.5	0.8	27.0	3.5	
BUB-88	8.8	3.5	21.85	1.5	1.0	4.0	3.5	
BUB-88S	7.8	3.5	21.85	1.5	1.0	4.0	3.5	
BUB-151	7.0	4.0	22.85	2.0	1.6	3.8	4.0	
BUB-158	7.8	4.4	23.1	2.5	0.8	3.6	4.4	
BUB-174	8.8	4.4	23.3	1.5	1.1	4.5	4.3	
BUB-199	8.0	4.3	27.0	1.5	1.2	3.8	4.5	

風扇鉚釘 FAN MOUNT RIVET

用途：用於電腦電源風扇之固定，降低噪音、牢固。
G:為45度硬度，H:為55度硬度



- Material: TPE/TPE (UL)
- G:Hardness is Shore A45
- H:Hardness is Shore A55
- Flame Class: 94V-0
- Color: Black
- Unit: mm

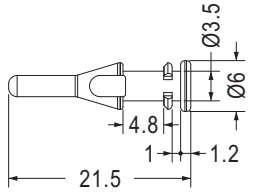

MOUNTING HOLE Ø3.5

Part No.	Package
BUB-234	1000

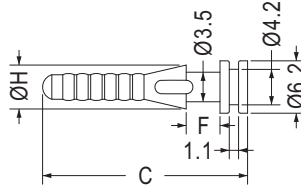

MOUNTING HOLE Ø3.5

Part No.	C	F	H	Package
BUB-194	24.3	4.0	5.2	1000
BUB-205	24.3	4.0	5.0	
BUB-218	25.3	5.0	5.0	

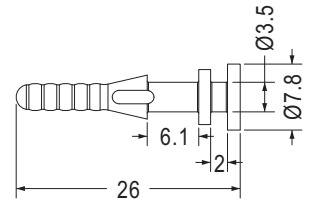

MOUNTING HOLE Ø3.5

Part No.	Package
BUB-231	1000

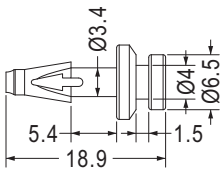

CHASSIS MOUNTING HOLE Ø4.0
FANS MOUNTING HOLE Ø3.5

Part No.	Package
BUB-180	1000

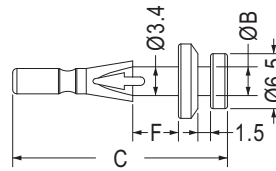

MOUNTING HOLE: ØG
FANS MOUNTING HOLE Ø3.5

Part No.	B	C	F	G	Package
BUB-96	3.4	25.4	5.4	3.5	1000
BUB-96-1	4.0	25.4	5.4	4.0	
BUB-97	3.4	26.4	6.4	3.5	

FANS MOUNTING HOLE Ø4.5
FANS THICKNESS 5.8

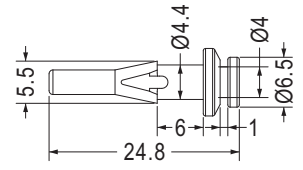

CHASSIS MOUNTING HOLE Ø4.0
CHASSIS THICKNESS 1.0

Part No.	Package
★BUB-243	1000

FAN MOUNTING HOLE Ø3.3
FAN THICKNESS 10.0

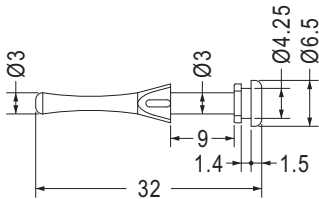

CHASSIS MOUNTING HOLE Ø4.4
CHASSIS THICKNESS 1.2

Part No.	Package
BUB-32	1000

FAN MOUNTING HOLE Ø3.3
FAN THICKNESS 10.0

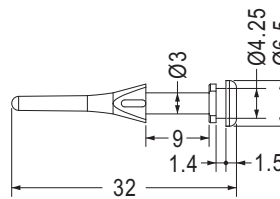

CHASSIS MOUNTING HOLE Ø4.4
CHASSIS THICKNESS 1.2

Part No.	Package
BUB-32S	1000

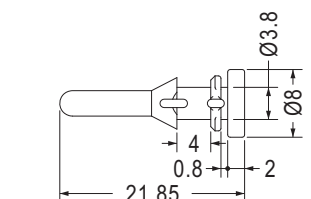

MOUNTING HOLE Ø4.4-Ø4.5
THICKNESS 0.8

Part No.	Package
BUB-182	1000

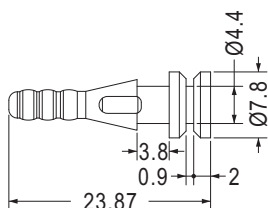

MOUNTING HOLE Ø4.4

Part No.	Package
BUB-152	1000

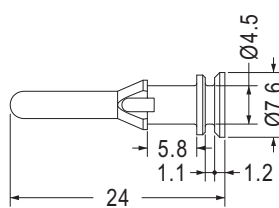

MOUNTING HOLE Ø4.5

Part No.	Package
BUB-202	1000

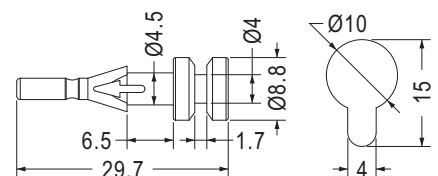

FAN MOUNTING Ø4.5 THICKNESS 6.8
MOUNTING HOLE THICKNESS 1.6

Part No.	Package
BUB-126	1000

風扇鉚釘 FAN MOUNT RIVET

用途：用於電腦電源風扇之固定，降低噪音、牢固。



- Material: TPE/TPE (UL)
- Flame Class: 94V-0
- Color: Black
- Unit: mm

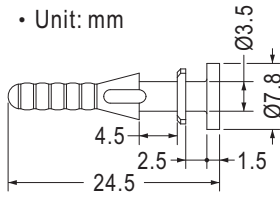

MOUNTING HOLE Ø3.5

Part No.	Package
BUB-209	1000

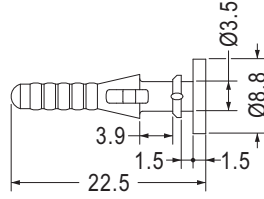

MOUNTING HOLE Ø3.5

Part No.	Package
BUB-213	1000

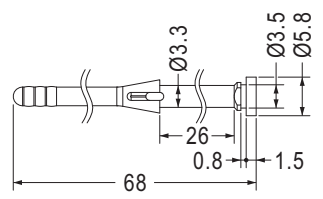

MOUNTING HOLE Ø3.4

Part No.	Package
★BUB-245	1000



- Material: Silicon Rubber
- Color: Black
- Unit: mm

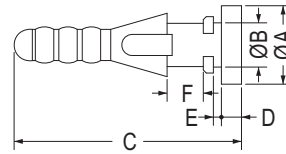

MOUNTING HOLE: ØG

Part No.	A	B	C	D	E	F	G	Package
BUB-23I	8.8	4.4	23.0	1.5	0.8	4.5	4.4	1000
BUB-130I	7.6	4.3	22.2	1.2	0.9	3.9	4.3	

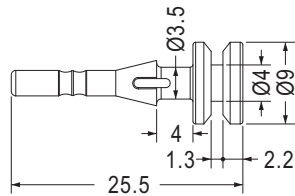

CHASSIS MOUNTING HOLE Ø4.0
FANS MOUNTING HOLE Ø3.5

Part No.	Package
BUB-25.5I	1000

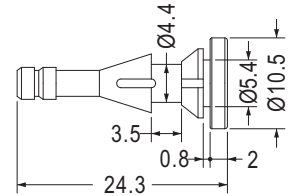

CHASSIS MOUNTING HOLE Ø5.5
FANS MOUNTING HOLE Ø4.5

Part No.	Package
BUB-7I	1000

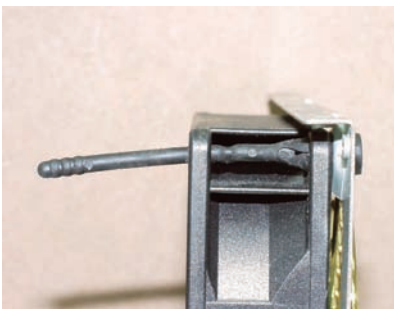

- Material: TPE/TPE (UL)
- G: Hardness is Shore A45
- H: Hardness is Shore A55
- Flame Class: 94V-0
- Color: Black
- Unit: mm

G: 為45度硬度，H: 為55度硬度

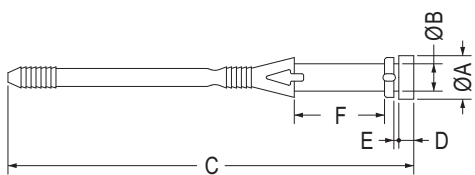

MOUNTING HOLE: ØG

Part No.	A	B	C	D	E	F	G	Package
BUB-9	6.0	3.3	30.9	1.2	1.0	8.0	3.3	1000
BUB-10	6.3	3.5	46.7	1.6	0.8	3.5	3.5	
BUB-35	7.5	4.4	35.0	2.0	1.2	3.0	4.4	
BUB-49	6.3	3.5	48.5	1.6	1.4	3.5	3.5	
BUB-53	7.5	4.4	53.3	2.0	1.2	3.0	4.4	
BUB-54	7.0	4.4	54.1	2.0	2.0	3.0	4.4	
BUB-57	5.2	3.5	57.3	1.5	0.8	19.0	3.5	
BUB-65	7.0	4.4	65.2	2.4	0.8	14.5	4.4	
BUB-65-1	7.0	4.4	62.0	1.7	0.8	14.5	4.4	
BUB-69	7.0	4.4	68.8	1.5	0.8	19.0	4.2	
BUB-71	7.0	4.4	71.0	2.4	1.6	19.5	4.4	
BUB-73	7.0	3.5	73.0	1.4	0.8	26.0	3.5	
BUB-74	7.5	4.4	70.0	2.0	0.8	3.0	4.4	
BUB-85	7.5	4.4	70.0	2.0	0.8	5.0	4.4	
BUB-100	6.0	3.1	55.33	1.7	1.0	18.0	3.3	
BUB-201	7.0	4.0	60.4	1.5	1.5	14.5	4.3	

風扇鉚釘 FAN MOUNT RIVET

用途：用於電腦電源風扇之固定，降低噪音、牢固。
G:為45度硬度，H:為55度硬度

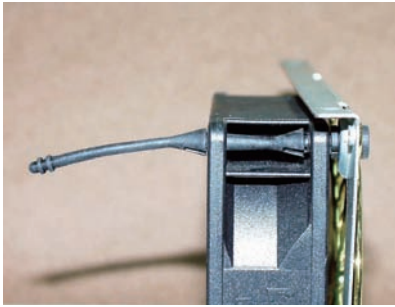

- Material: TPE/TPE (UL)
- G:Hardness is Shore A45
- H:Hardness is Shore A55
- Flame Class: 94V-0
- Color: Black
- Unit: mm

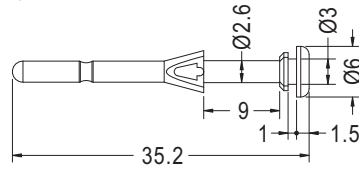

MOUNTING HOLE Ø3.2

Part No.	Package
BUB-127	1000

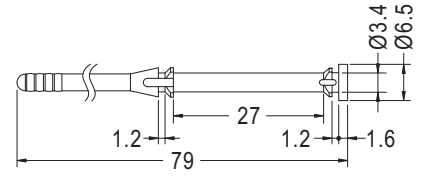

CHASSIS MOUNTING HOLE Ø3.7
FANS MOUNTING HOLE Ø3.5

Part No.	Package
BUB-79	500

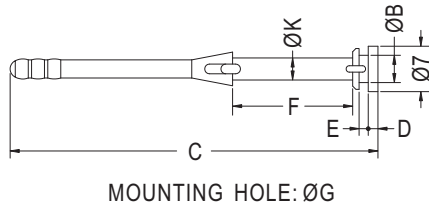

MOUNTING HOLE: ØG

Part No.	B	C	D	E	F	G	K	Package
BUB-48	4.2	48.0	1.4	0.8	3.5	4.4	3.5	1000
BUB-56	4.2	56.7	1.5	1.4	18.5	4.4	3.4	
BUB-76	4.2	75.1	1.4	2.9	26.0	4.4	3.4	
BUB-83	4.4	69.2	1.4	0.8	19.5	4.6	4.0	
BUB-150	3.5	57.3	2.5	0.8	19.0	3.7	3.5	
BUB-150S	3.5	57.2	1.4	0.8	19.0	3.7	3.5	
BUB-153	3.5	74.8	1.4	2.6	26.0	3.7	3.4	
BUB-184	3.96	73.94	0.98	0.91	27.0	4.2	3.4	

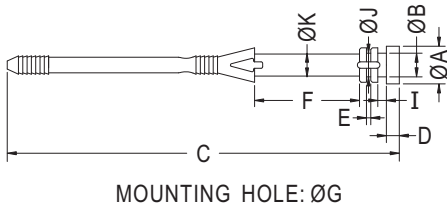

MOUNTING HOLE: ØG

Part No.	A	B	C	D	E	F	G	I	J	K	Package
BUB-4	9.0	4.5	24.7	1.5	1.0	3.5	4.7	1.5	4.0	4.0	1000
BUB-26	8.8	4.4	25.2	1.6	0.8	4.5	4.6	1.6	4.4	4.4	
BUB-68	8.0	4.0	68.0	1.5	1.0	4.0	4.2	1.5	4.0	4.0	
BUB-72	7.0	4.4	72.0	2.4	0.8	19.5	4.7	1.6	4.4	4.1	

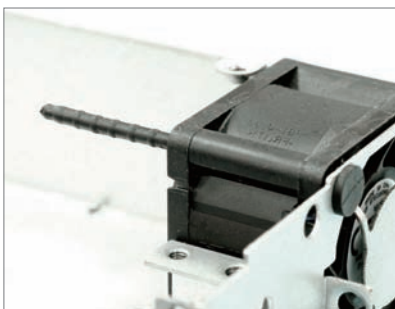

HOLE IN FAN Ø3.5
THICKNESS 10.0

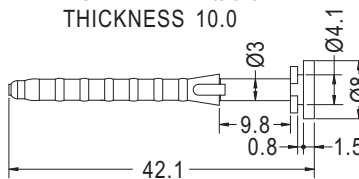

MOUNTING HOLE Ø4.4
THICKNESS 0.8~1.0

Part No.	Package
BUB-179	1000

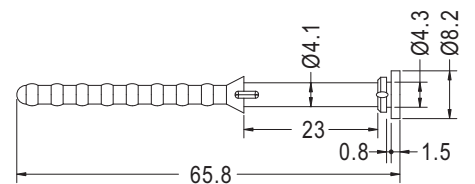

MOUNTING HOLE Ø4.4

Part No.	Package
BUB-66	1000

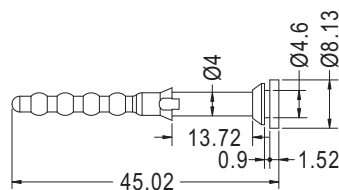

MOUNTING HOLE Ø5.5
THICKNESS 0.9

Part No.	Package
BUB-175L	1000

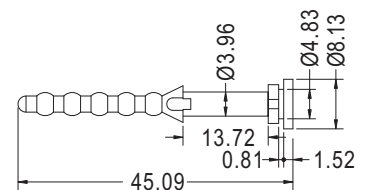

MOUNTING HOLE Ø5.1

Part No.	Package
BUB-45	1000

風扇鉚釘 FAN MOUNT RIVET

用途：用於電腦電源風扇之固定，降低噪音、牢固。
G:為45度硬度，H:為55度硬度



- Material: TPE/TPE (UL)
- G:Hardness is Shore A45
- H:Hardness is Shore A55
- Flame Class: 94V-0
- Color: Black
- Unit: mm

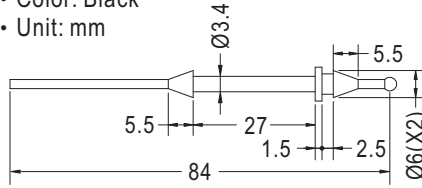

MOUNTING HOLE Ø4.3

Part No.	Package
BUB-159	1000

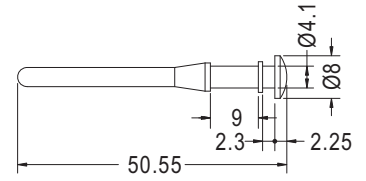

MOUNTING HOLE Ø4.3

Part No.	Package
BUB-225	1000

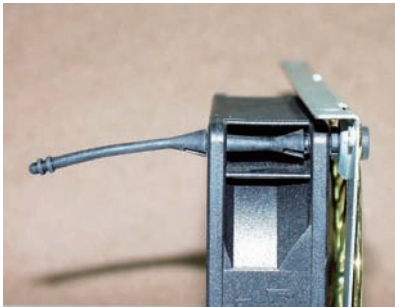

- Material: Silicon Rubber
- Color: Black
- Unit: mm

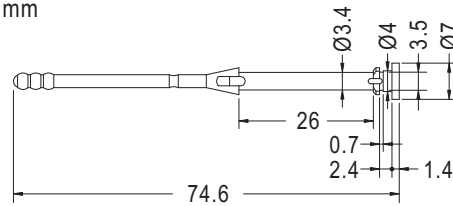

MOUNTING HOLE Ø3.5

Part No.	Package
BUB-211I	1000

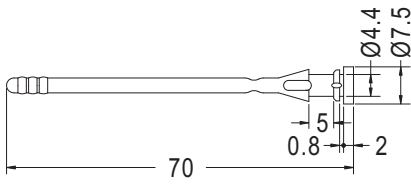

MOUNTING HOLE Ø4.5

Part No.	Package
BUB-85I	1000

HOLE IN FAN Ø3.5
THICKNESS 28.0

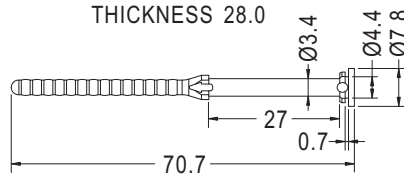

MOUNTING HOLE Ø4.5
THICKNESS 0.8

Part No.	Package
BUB-161I	1000

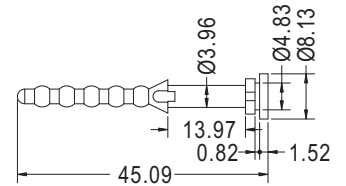

MOUNTING HOLE Ø5.1

Part No.	Package
BUB-45I	1000



HOLE IN FAN Ø4.4
THICKNESS 15.0

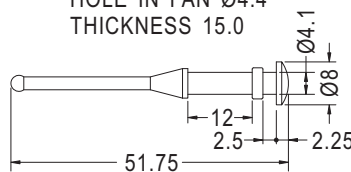

MOUNTING HOLE Ø4.4
THICKNESS 2.5

Part No.	Package
TF-268I	1000



- Material: Silicon Rubber (UL)
- Flame Class: 94V-0
- Color: Black
- Unit: mm

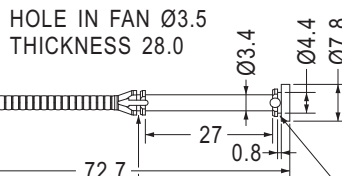

MOUNTING HOLE Ø3.5
THICKNESS 0.8

MOUNTING HOLE Ø4.5
THICKNESS 0.8

Part No.	Package
BUB-235I	1000

風扇鉚釘 FAN MOUNT RIVET

用途：用於電腦電源風扇之固定，降低噪音、牢固。
G:為45度硬度，H:為55度硬度



- Material: TPE/TPE (UL)
- G:Hardness is Shore A45
- H:Hardness is Shore A55
- Flame Class: 94V-0
- Color: Black
- Unit: mm

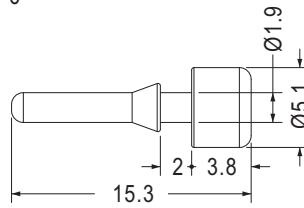

MOUNTING HOLE Ø2.0

Part No.	Package
BUB-138	1000

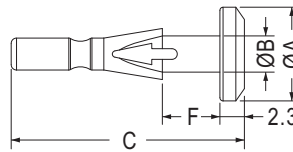

MOUNTING HOLE : ØG

Part No.	A	B	C	F	G	Package
BUB-136	8.8	3.4	21.9	5.4	3.5	1000
BUB-172	8.5	4.1	22.0	4.5	4.5	

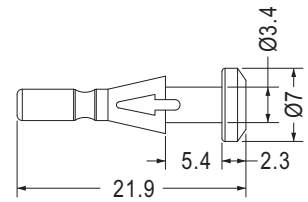

MOUNTING HOLE Ø3.6

• Material: Silicon Rubber

Part No.	Package
BUB-219I	1000

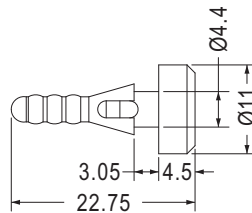

MOUNTING HOLE Ø4.3
THICKNESS 4.0

Part No.	Package
BUB-155	1000

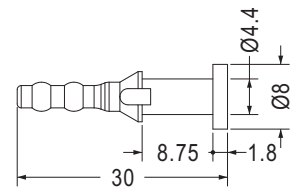

MOUNTING HOLE Ø4.4~Ø4.5

Part No.	Package
BUB-196	1000

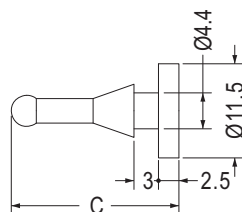

MOUNTING HOLE Ø4.6

Part No.	C	Package
BUB-90	20.5	1000
BUB-124	40.5	

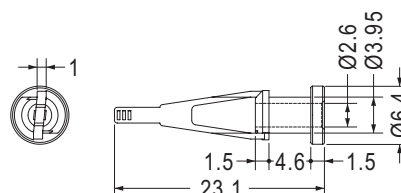

MOUNTING HOLE Ø4.2

Part No.	Package
BUB-95	1000

風扇鉚釘 FAN MOUNT RIVET

用途：用於電腦電源風扇之固定，降低噪音、牢固。
G:為45度硬度，H:為55度硬度



- Material: TPE/TPE (UL)
- G:Hardness is Shore A45
- H:Hardness is Shore A55
- Flame Class: 94V-0
- Color: Black
- Unit: mm

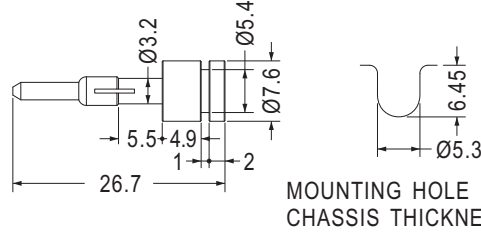

Part No.	Package
BUB-139	1000

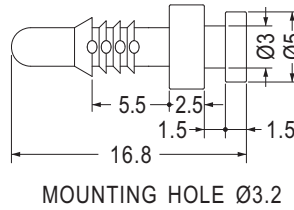

Part No.	Package
BUB-16.7	1000

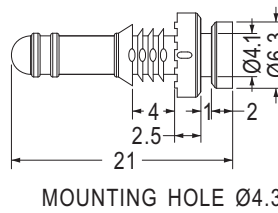

MOUNTING HOLE Ø4.3

Part No.	Package
BUB-171	1000

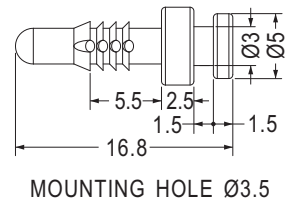

MOUNTING HOLE Ø3.5

Part No.	Package
BUB-177	1000

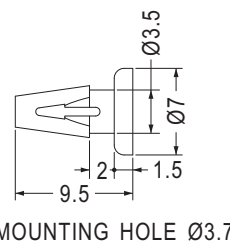

MOUNTING HOLE Ø3.7

Part No.	Package
BUB-132	1000

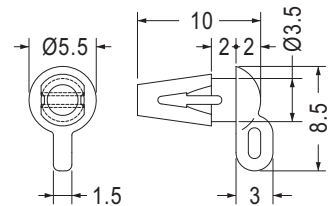

MOUNTING HOLE Ø3.7

Part No.	Package
BUB-133	1000



- Material: TPE (UL)
- Flame Class: 94V-0
- Color: Black
- Unit: mm

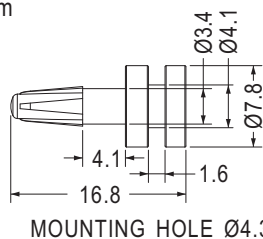

MOUNTING HOLE Ø4.3

Part No.	Package
BUB-217	1000

- Material: TPR
- Color: Black
- Unit: mm

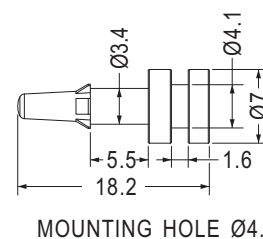

MOUNTING HOLE Ø4.3

Part No.	Package
BUB-233	1000

風扇鉚釘 FAN MOUNT RIVET

用途：用於電腦電源風扇之固定，降低噪音、牢固。



- Material: Silicon Rubber
- Color: Black
- Unit: mm

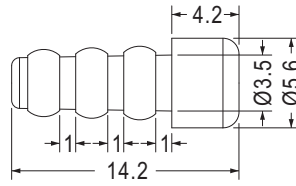

MOUNTING HOLE Ø4.5

Part No.	Package
BUB-86I	1000

塑膠鉚釘 MOUNTING BUTTON

用途：用於風扇鉚釘之固定。



- Material: Nylon 66 (UL)
- Flame Class: 94V-2/94V-0
- Color: Black
- Unit: mm
- Patented (專利品)

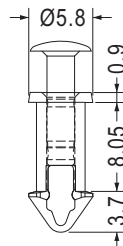

MOUNTING HOLE Ø4.4~Ø4.5
THICKNESS 8.0

Part No.	Package
SRMKA-8	1000

風扇鉚釘 FAN MOUNT RIVET

用途：用於電腦電源風扇之固定，降低噪音、牢固。



- Body Material: TPE
- Pin Material: Nylon 66 (UL)
- Flame Class: 94V-2
- Color: Black
- Unit: mm

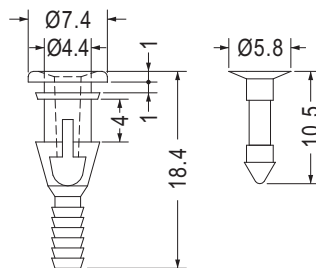

MOUNTING HOLE Ø4.8~Ø5.0

Part No.	Package
FSP-1	1000

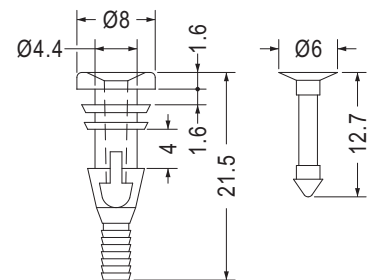

MOUNTING HOLE Ø4.8~Ø5.0

Part No.	Package
FSP-2	1000

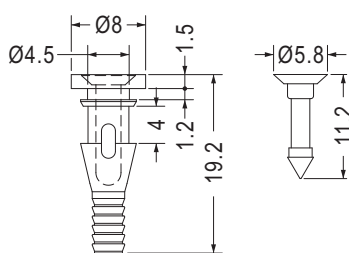

MOUNTING HOLE Ø4.5

Part No.	Package
FSP-3	1000

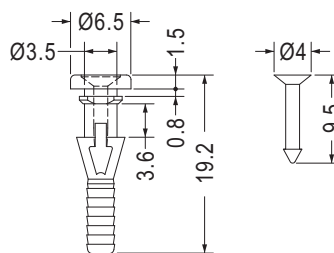

MOUNTING HOLE Ø3.5

Part No.	Package
FSP-10	1000

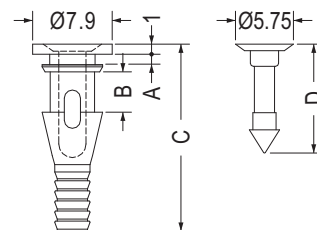

MOUNTING HOLE: ØG

Part No.	A	B	C	D	G	Package
FSP-4	1.05	3.9	18.55	10.8	4.5~4.7	1000
FSP-5	0.9	3.9	14.3	10.8	4.5~4.7	
FSP-6	1.6	5.0	20.1	12.1	4.5	

風扇鉚釘 FAN MOUNT RIVET

用途：用於電腦電源風扇之固定，降低噪音、牢固。



- Material: TPE
- Pin Material: Nylon 66 (UL)
- Flame Class: 94V-2
- Color: Black
- Unit: mm

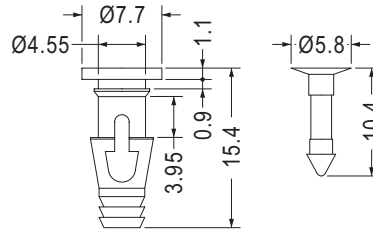

MOUNTING HOLE Ø4.5-Ø4.7

Part No.	Package
FSP-9	1000

散熱片扣件 HEAT SINK RIVET

用途：用於兩片零件間之固定。

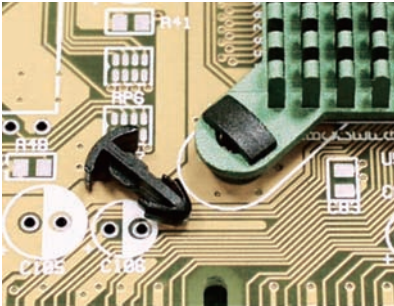

- Material: Nylon 66 (UL)
- Flame Class: 94V-2/94V-0
- Color: Natural/Black
- Unit: mm

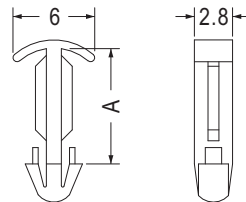

MOUNTING HOLE Ø3.0

Part No.	A	Package
MBB-6	6.0	2000
MBB-7	7.0	
MBB-8	8.0	

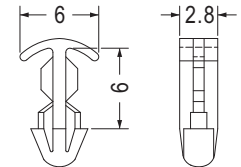

MOUNTING HOLE Ø3.0

Part No.	Package
MBB-6A	2000

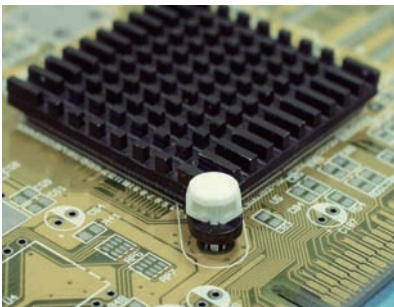

- Material: Nylon 66 (UL)
- Flame Class: 94V-2/94V-0
- Color: Natural/Black
- Unit: mm

用途：用於PC板上與IC散熱片間固定，方便、牢固。

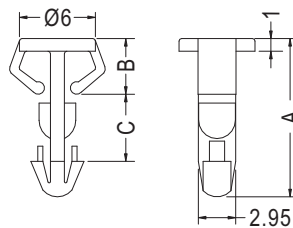

MOUNTING HOLE Ø3.0

Part No.	A	B	C	Package
MCC-1	12.5	4.4	5.3	2000
MCC-2	12.7	5.3	4.7	
MCC-3	10.3	5.0	2.5	

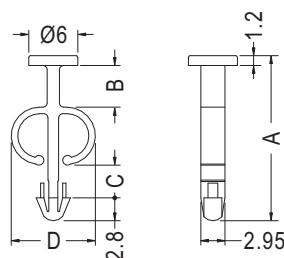

MOUNTING HOLE Ø3.0

Part No.	A	B	C	D	Package
MEE-1	20.3	5.1	4.0	10.1	1000
MEE-2	17.0	2.5	3.4	10.3	

散熱片扣件 HEAT SINK RIVET

用途：用於PC板上與IC散熱片間固定，方便、牢固。

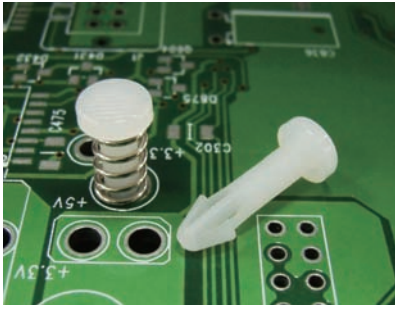

- Material: Nylon 66 (UL)
- Flame Class: 94V-2/94V-0
- Color: Natural/Black
- Unit: mm

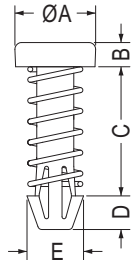

P.C.B: ØG

- PC板Ø3.0散熱片孔徑建議開Ø3.2
- PC板Ø3.5散熱片孔徑建議開Ø3.7
- PC板Ø4.0散熱片孔徑建議開Ø4.2~Ø4.3
- 彈簧尺寸可依客戶訂製

Applications: Use on PC Boards and affix Heat Sinks, stable and easy to use.

- PC Boards Ø 3.0, suggests for a Heat Sink of Ø 3.2 in diameter.
- PC Boards Ø 3.5, suggests for a Heat Sink of Ø 3.7 in diameter.
- PC Boards Ø 4.0, suggests for a Heat Sink of Ø 4.2 - 4.3 in diameter.
- Custom spring sizes are available upon request.

Part No.	A	B	C	D	E	G	Package
HSR-4	4.3	1.5	11.5	2.5	4.3	3.0	1000
HSR-6	6.4	1.5	8.7	2.5	4.3	3.0	
HSR-6S	6.35	1.5	8.7	2.5	4.0	3.0	
HSR-7	6.4	1.5	10.6	2.5	4.3	3.0	
HSR-9	6.4	1.5	11.5	2.5	4.4	3.0	
HSR-10	5.0	1.75	8.3	2.5	4.3	3.0	
HSR-11	6.4	2.75	21.0	2.5	4.3	3.0	
HSR-12	5.5	1.5	8.7	3.6	4.0	3.0	
HSR-13	6.2	1.0	7.8	2.5	4.2	3.0	
HSR-16	6.3	1.5	11.5	2.1	4.2	3.0	
HSR-23	6.4	1.5	11.4	2.6	4.3	3.0	
HSR-24	5.5	1.5	14.0	2.8	4.1	3.0	
HSR-25	5.5	1.6	11.4	3.0	4.0	3.0	
HSR-26	6.4	1.5	11.5	2.5	4.8	3.5	
HSR-30	5.0	1.75	12.32	2.5	4.3	3.0	
HSR-31	6.4	1.5	11.4	2.5	4.5	3.0	
HSR-32	5.5	1.5	9.0	1.9	3.6	3.0	
HSR-33	6.4	1.5	11.4	2.5	4.8	3.5	
HSR-34	6.0	1.9	17.6	2.5	4.2	3.0	
HSR-35	6.2	1.0	9.0	2.5	4.3	3.0	
HSR-41	5.5	1.5	10.0	2.5	4.3	3.0	
HSR-42	5.5	1.5	12.0	2.5	4.3	3.0	
HSR-44	5.5	1.5	9.0	3.5	4.3	3.0	
HSR-45	6.5	1.5	11.1	3.5	5.4	4.0	
HSR-49	6.3	0.8	5.7	2.1	4.2	3.0	
HSR-50	6.2	1.0	7.0	2.5	4.3	3.0	

Part No.	A	B	C	D	E	G	Package
HSR-51	8.0	1.6	16.5	3.3	5.5	4.0	1000
HSR-53	5.5	1.0	7.4	2.1	4.2	3.0	
HSR-56	6.5	1.5	11.1	3.5	5.15	4.0	
HSR-57	5.5	0.8	6.6	2.1	4.2	3.0	
HSR-61	4.7	1.2	12.7	2.0	3.6	2.7	
HSR-62	6.3	1.5	25.5	2.7	4.0	3.0	
HSR-64	6.4	1.5	10.6	2.5	4.3	3.0	
HSR-65	5.5	1.5	9.0	1.9	3.8	3.2	
HSR-66	6.5	1.5	22.7	3.85	5.35	4.0	
HSR-68	6.2	1.2	11.0	1.5	4.3	3.0	
HSR-72	5.5	1.5	11.0	1.9	3.6	3.0	
HSR-73	8.0	1.5	15.85	2.7	5.5	4.0	
HSR-83	5.8	1.5	17.0	1.7	4.3	3.0	
HSR-85	8.0	1.5	15.8	4.0	5.5	4.0	
HSR-93	6.4	1.6	12.7	2.8	4.3	3.0	
HSR-95	8.0	1.6	15.5	3.3	5.3	3.8	
HSR-96	6.4	1.8	14.0	3.3	4.0	3.0	
HSR-97	6.2	1.2	13.5	1.3	4.3	3.0	
HSR-98	5.5	0.8	8.4	2.1	4.2	3.0	
HSR-110	6.2	1.0	7.4	2.5	4.3	3.05	
HSR-112	6.2	1.2	11.0	2.5	4.3	3.05	
HSR-118	6.4	1.5	12.8	2.5	4.3	3.05	
★HSR-120	4.3	1.5	11.5	3.5	4.3	3.05	
HSR-121	6.4	1.5	9.9	2.5	4.0	2.85	

散熱片扣件 HEAT SINK RIVET

用途：用於PC板上與IC散熱片間固定，方便、牢固。

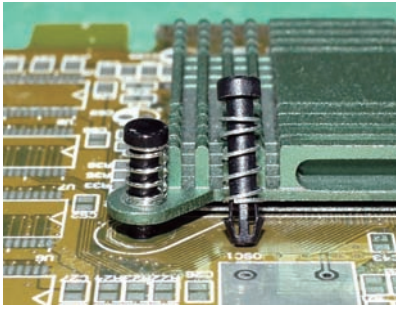

- Material: Nylon 66 (UL)
- Flame Class: 94V-2/94V-0
- Color: Natural/Black
- Unit: mm

- PC板Ø2.5散熱片孔徑建議開Ø2.7
- PC板Ø2.7散熱片孔徑建議開Ø2.9
- PC板Ø3.0散熱片孔徑建議開Ø3.2
- 彈簧尺寸可依客戶訂製

Applications: Use on PC Boards and affix Heat Sinks, stable and easy to use.

- PC Boards Ø 2.5, suggests for a Heat Sink Of Ø 2.7 in diameter
- PC Boards Ø 2.7, suggests for a Heat Sink Of Ø 2.9 in diameter
- PC Boards Ø 3.0, suggests for a Heat Sink Of Ø 3.2 in diameter
- Custom spring sizes are available upon request

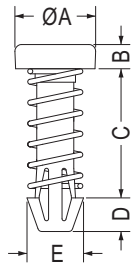

P.C.B: ØG

Part No.	A	B	C	D	E	G	Package
HSR-14	4.6	5.9	13.0	3.5	4.2	3.0	1000
HSR-29	6.4	0.9	9.5	3.3	4.0	3.0	
HSR-55	6.0	1.8	9.6	2.5	4.0	3.0	
HSR-91	4.7	1.2	11.8	2.0	3.6	2.7	



- Material: Nylon 66 (UL)
- Flame Class: 94V-2/94V-0
- Color: Natural/Black
- Unit: mm

- PC板Ø3.0散熱片孔徑建議開Ø3.2
- PC板Ø3.5散熱片孔徑建議開Ø3.7
- PC板Ø4.0散熱片孔徑建議開Ø4.2~Ø4.3
- 彈簧尺寸可依客戶訂製

Applications: Use on PC Boards and affix Heat Sinks, stable and easy to use.

- PC Boards Ø 3.0, suggests for a Heat Sink of Ø 3.2 in diameter
- PC Boards Ø 3.5, suggests for a Heat Sink of Ø 3.7 in diameter
- PC Boards Ø 4.0, suggests for a Heat Sink of Ø 4.2 - 4.3 in diameter
- Custom spring sizes are available upon request

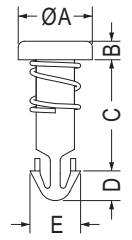

P.C.B: ØG

Part No.	A	B	C	D	E	G	Package
HSR-12.7	6.4	1.6	12.7	3.2	4.2	3.0	1000
HSR-38	6.0	1.5	9.0	2.4	4.1	3.2	
HSR-60	6.3	0.8	5.7	2.7	4.2	3.0	

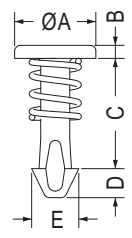

P.C.B: ØG

Part No.	A	B	C	D	E	G	Package
HSR-37	5.0	1.0	10.0	2.0	2.0	1.5	1000
HSR-39	5.6	1.2	12.7	2.0	3.1	2.3	
HSR-40	4.7	1.2	12.4	2.0	3.1	2.3	
HSR-48	5.6	0.9	7.6	2.1	3.3	2.2	
HSR-54	5.6	0.9	11.6	2.0	3.3	2.2	
HSR-67	5.0	1.0	10.0	2.0	2.2	1.7	
HSR-71	4.7	1.2	12.4	1.5	3.1	2.3	
HSR-89	4.5	0.9	7.7	2.0	3.3	2.2	



- Material: Nylon 66 (UL)
- Flame Class: 94V-2/94V-0
- Color: Natural/Black
- Unit: mm

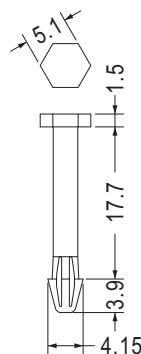

Part No.	Package
HSR-103	1000

HOLE IN P.C.B Ø3.0
HOLE HEAT SINK Ø3.2~Ø3.4

散熱片扣件 HEAT SINK RIVET

用途：用於PC板上與IC散熱片間固定，方便、牢固。



- Material: Nylon 66 (UL)
- Flame Class: 94V-2/94V-0
- Color: Natural/Black
- Unit: mm

- PC板 $\varnothing 3.0$ 散熱片孔徑建議開 $\varnothing 3.2$
- Applications: Use on PC Boards and affix Heat Sinks, stable and easy to use.
- PC Boards $\varnothing 3.0$, suggests for a Heat Sink Of $\varnothing 3.2$ in diameter

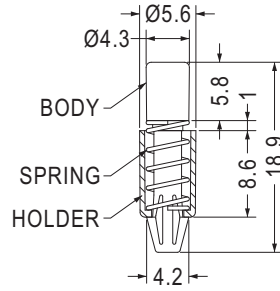

HOLE IN P.C.B $\varnothing 3.0$
HOLE IN HEAT SINK $\varnothing 3.2$

Part No.	Package
HSR-1	1000

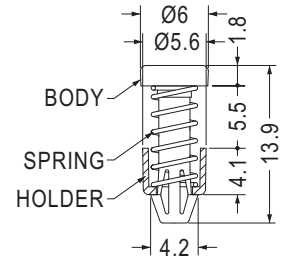

HOLE IN P.C.B $\varnothing 3.0$
P.C.B THICKNESS 1.2~1.7

Part No.	Package
HSR-2	1000

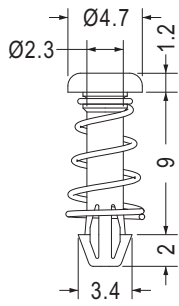

P.C.B $\varnothing 2.5$

Part No.	Package
HSR-36	1000

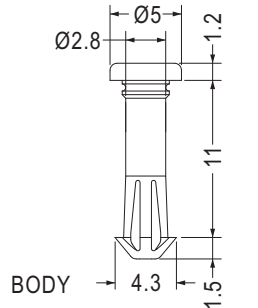

HOLE IN P.C.B $\varnothing 3.05$
HOLE IN HEAT SINK $\varnothing 3.2$

Part No.	Package
HSR-109	1000

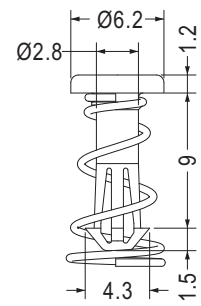

P.C.B $\varnothing 3.0$

Part No.	Package
HSR-74-201	1000

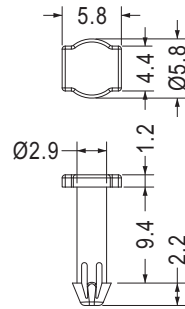

HOLE IN P.C.B $\varnothing 3.0$
HOLE HEAT SINK $\varnothing 3.2$

Part No.	Package
HSR-90	1000

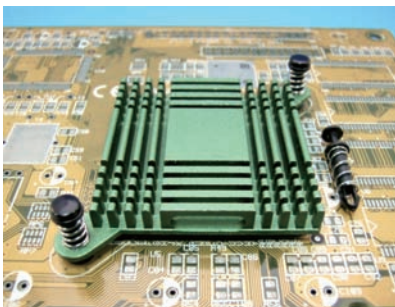

HOLE IN P.C.B $\varnothing 3.5$
THICKNESS 1.6

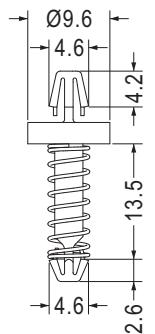

HOLE IN P.C.B $\varnothing 3.5$

Part No.	Package
HSR-58	1000

P.C.B $\varnothing 3.3$
THICKNESS 1.6

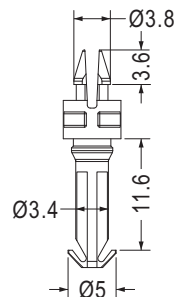

P.C.B $\varnothing 4.0$
THICKNESS 0.8~1.0

Part No.	Package
HSRD-2	1000

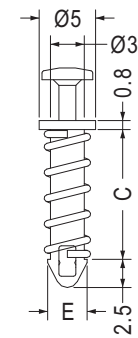

MOUNTING HOLE $\varnothing 3.0$

Part No.	C	E	Package
SRMK-8.5	8.5	3.7	1000
SRMK-11.5	11.5	3.5	

- Material: Nylon 66 (UL)
- Flame Class: 94V-2/94V-0
- Color: Natural/Black
- Unit: mm

插銷 PIN



- Material: Nylon 66 (UL)
- Flame Class: 94V-2/94V-0
- Color: Natural/White/Black
- Unit: mm
- Patented (專利品)

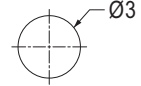
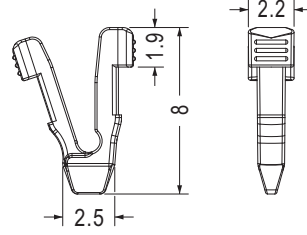

RECOMMEND MOUNTION HOLE
RECOMMEND THICKNESS 2.0

Part No.	Package
MBTA-1	2000

用途：加強散熱片銅插銷之固定，避免震動脫落。

喇叭座 SPEAKER HOLDER

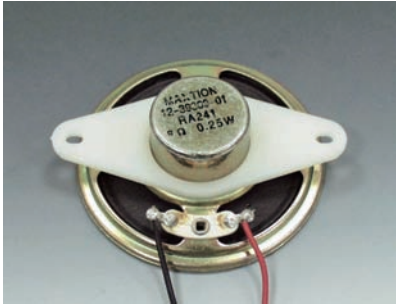

- Material: Nylon 66 (UL)
- Flame Class: 94V-2/94V-0
- Color: Natural/Black
- Unit: mm

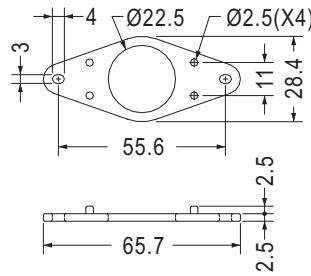

Part No.	Package
SPK-1	250

用途：將Ø50喇叭固定於機板上。

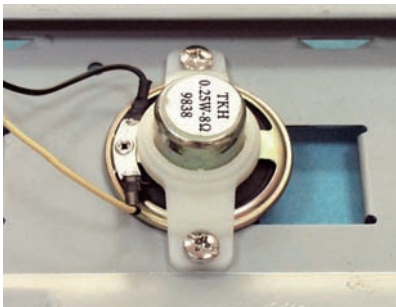

- Material: Nylon 66 (UL)
- Flame Class: 94V-2/94V-0
- Color: Natural/Black
- Unit: mm

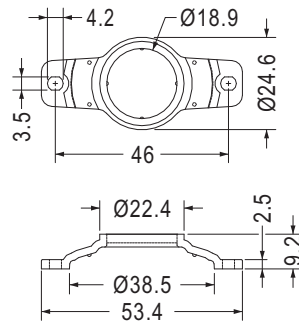

Part No.	Package
SPK-2	250

用途：將Ø38喇叭固定於機板上。

喇叭箱扣 SPEAKER BOX BUCKLE



- Body Material: TPE
- Pin Material: Nylon 66 (UL)
- Flame Class: 94V-2/94V-0
- Color: Black
- Unit: mm

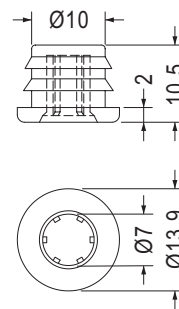

BODY

MOUNTING HOLE Ø10.5
THICKNESS 2.5

Part No.	Package
SPLK-1FA	500

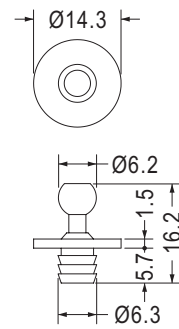

PIN

MOUNTING HOLE Ø6.1
THICKNESS 6.4

Part No.	Package
SPLK-1FB	500

用途：固定音箱外蓋用。

喇叭箱扣 SPEAKER BOX BUCKLE

用途：固定音箱外蓋用。



- Body Material: TPU
- Pin Material: Nylon 66 (UL)
- Flame Class: 94V-2/94V-0
- Color: Black
- Unit: mm

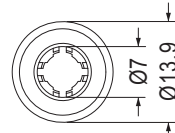
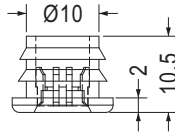

MOUNTING HOLE Ø10.5
THICKNESS 2.5

Part No.	Package
SPLK-2FA	500

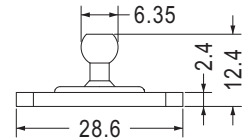
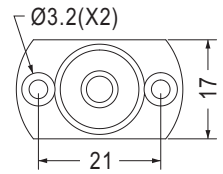

PIN

Part No.	Package
SPLK-2FB	500

門扣擋銷 DOOR LOCK TIP

用途：用於面板固定用。



- Body Material: POM
- Pin Material: Nylon 66 (UL)
- Flame Class: 94V-2/94V-0
- Color: Black
- Unit: mm

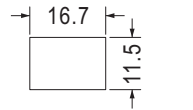
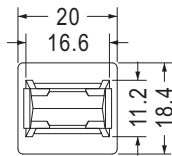

MOUNTING HOLE
THICKNESS 1.6~1.8

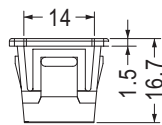

門扣本體
DOOR LOCK BODY

Part No.	Package
DTTL-1A	500

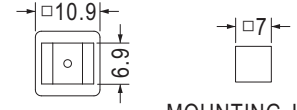

MOUNTING HOLE
THICKNESS 1.2~1.5

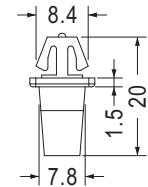

PIN

Part No.	Package
DTTL-1B	500

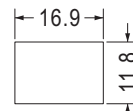
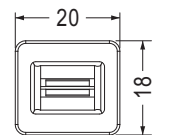

MOUNTING HOLE
THICKNESS 0.8~1.2

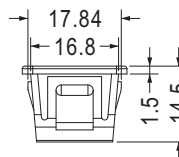

門扣本體
DOOR LOCK BODY

Part No.	Package
DTTL-3A	500

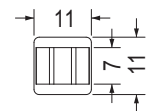

MOUNTING HOLE
THICKNESS 0.8~1.2

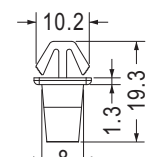

PIN

Part No.	Package
DTTL-3B	500

門扣擋銷 DOOR LOCK TIP

用途：用於面板固定用。



- Material: Nylon 66 (UL)
- Flame Class: 94V-2/94V-0
- Color: Natural
- Unit: mm

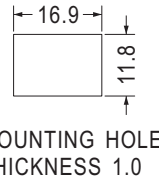
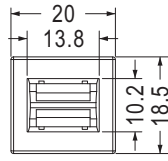

MOUNTING HOLE THICKNESS 1.0

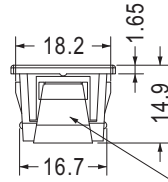

【 DTLL-7AF 】

CLAMP STEEL ZINC PLATED

- Material: POM

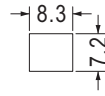
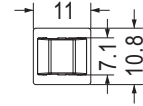

MOUNTING HOLE THICKNESS 0.8~1.2

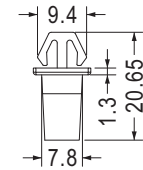

【 DTLL-7B 】

Part No.	Part No.	Package
DTTL-7	DTTL-7AF	250
	DTTL-7B	
此為子母包:內容物包含右方零件		



- Material: Nylon 66 (UL)
- Flame Class: 94V-2/94V-0
- Color: Black
- Unit: mm

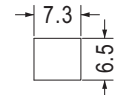
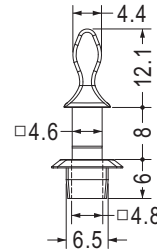
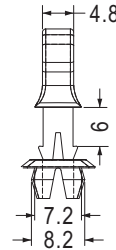

MOUNTING HOLE THICKNESS 0.8~1.5

Part No.	Package
DTTL-4	500

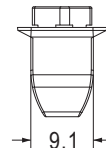
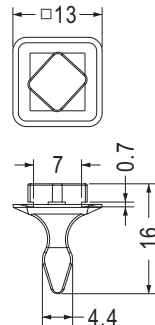

MOUNTING HOLE THICKNESS 0.8

Part No.	Package
DTTL-5B	500

固定扣 SNAP LATCH

用途：固定於機器上，牢固結合不脫落。



- Material: Nylon 66 (UL)
- Flame Class: 94V-2/94V-0
- Color: Natural/Black
- Unit: mm

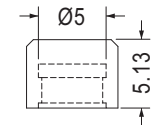
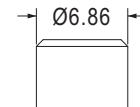
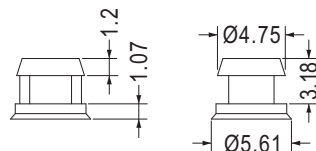

Part No.	Package
LO-6052A	1000

Part No.	Package
LO-6052B	1000

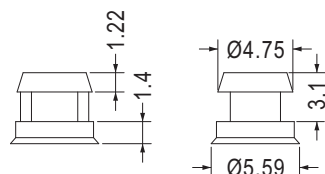

Part No.	Package
LO-6053A	1000

固定扣 SNAP LATCH

用途：固定於機器上，牢固結合不脫落。



- Material: Nylon 66 (UL)
- Flame Class: 94V-2/94V-0
- Color: Natural/Black
- Unit: mm

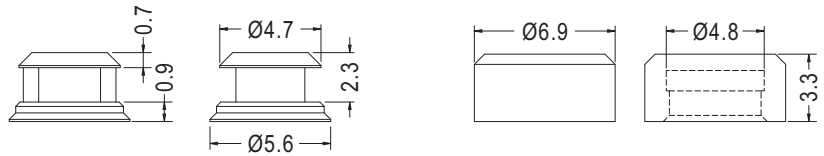

Part No.	Package
LO-6055A	1000

Part No.	Package
LO-6055B	1000

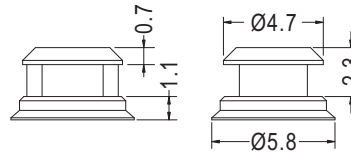

Part No.	Package
LO-6056A	1000

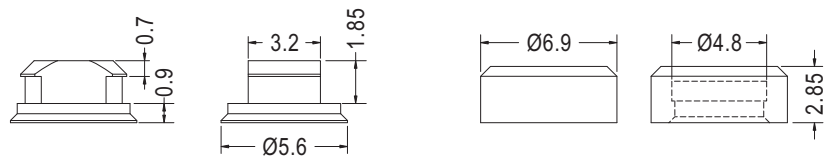

Part No.	Package
LO-6057A	1000

Part No.	Package
LO-6057B	1000

零件座 PARTS HOUSING

用途：用於零件座。

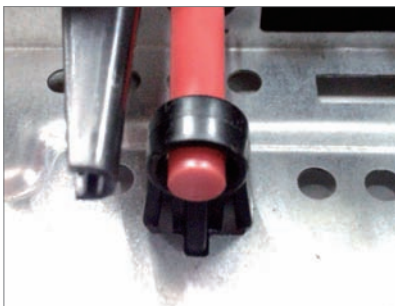

- Material: PS
- Color: Black
- Unit: mm

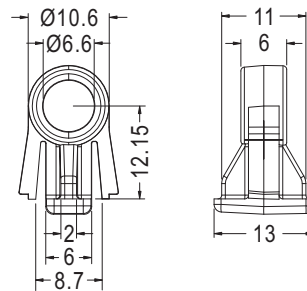

Part No.	Package
EMU-5	1000

門扣 DOOR LOCK

用途：用於機器之開關門扣，方便機器門之開與關。



- Catcher Material: Nylon 66 (UL)/94V-2
- Case Material: POM (UL)/94HB
- Color: Black
- Unit: mm

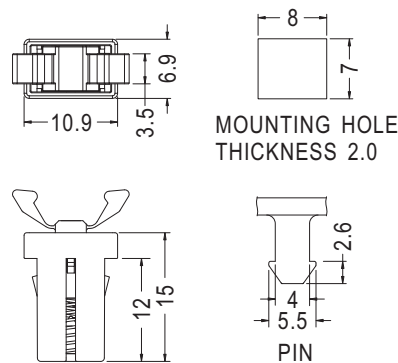

Part No.	Package
DT-1	500

門扣 DOOR LOCK

用途：用於機器之開關門扣，方便機器門之開與關。

- Catcher Material: Nylon 66 (UL)/94V-2
- Case Material: POM (UL)/94HB
- Color: Black
- Unit: mm

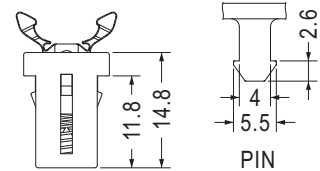
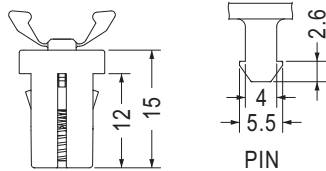
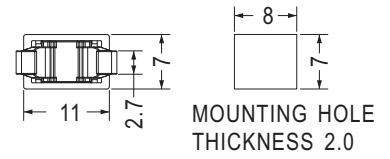
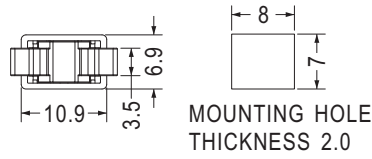

Part No.	Package
DT-18	500

Part No.	Package
DT-51	500

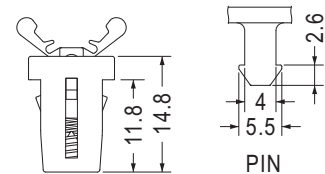
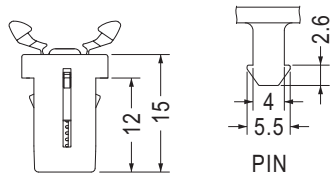
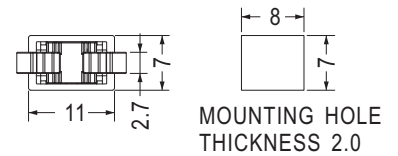
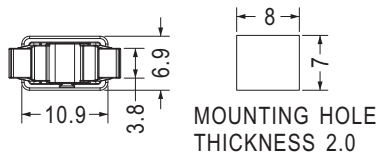

Part No.	Package
DT-16	500

Part No.	Package
DT-4	500

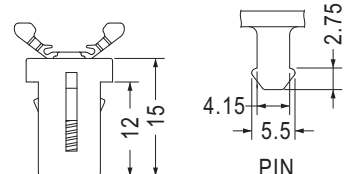
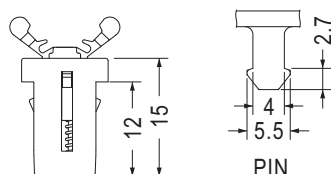
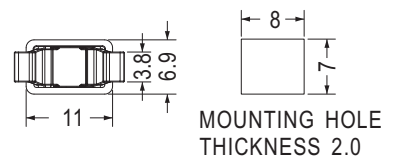
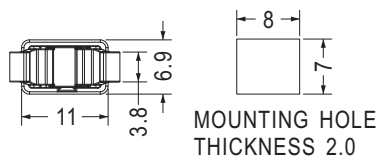

Part No.	Package
DT-19	500

Part No.	Package
DT-21	500

門扣 DOOR LOCK

用途：用於機器之開關門扣，方便機器門之開與關。



- Catcher Material: Nylon 66 (UL)/94V-2
- Case Material: POM (UL)/94HB
- Color: Black
- Unit: mm

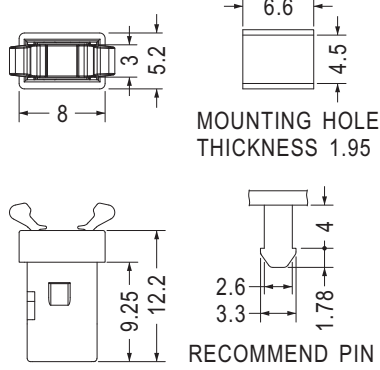

Part No.	Package
DT-22	500



- Material: Nylon 66 (UL)
- Flame Class: 94V-2/94V-0
- Color: Black
- Unit: mm

用途：可配合DT-22之門扣，方便機器門之開與關。

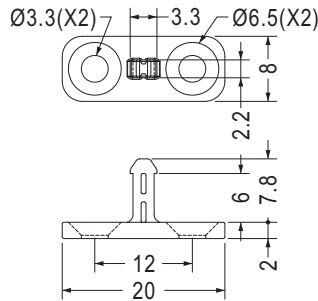

Part No.	Package
DTA-4	500



- Material: ABS (UL)
- Flame Class: 94HB
- Color: Black
- Unit: mm

用途：可配合DT-1之門扣，方便機器門之開與關。

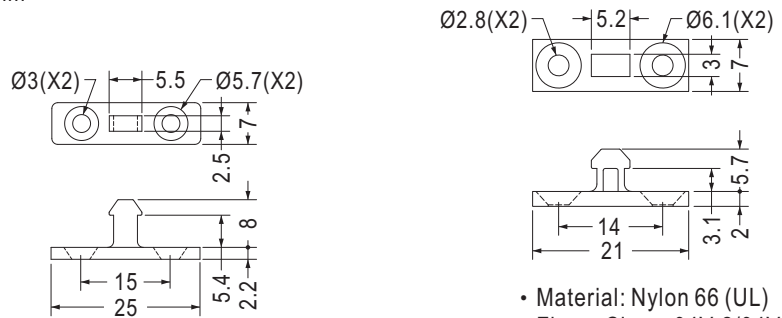

Part No.	Package
DTA-1	500

Part No.	Package
DTA-3	500



- Catcher Material: Nylon 66 (UL)/94V-2
- Case Material: POM (UL)/94HB
- Color: Black
- Unit: mm

用途：用於機器之開關門扣，方便機器門之開與關。

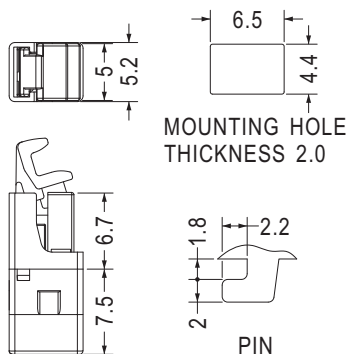

Part No.	Package
DT-12	500

門扣 DOOR LOCK

用途：用於機器之開關門扣，方便機器門之開與關。



- Catcher Material: Nylon 66 (UL)/94V-2
- Case Material: POM (UL)/94HB
- Color: Black
- Unit: mm

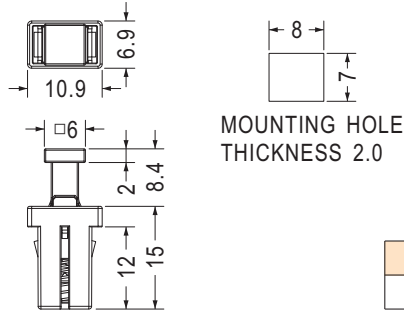

Part No.	Package
DT-14	500



- Material: Nylon 66 (UL)
- Flame Class: 94V-2/94V-0
- Color: Black
- Unit: mm

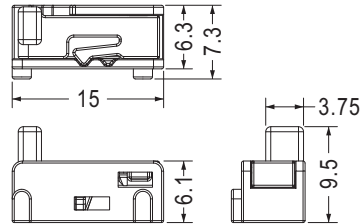

Part No.	Package
DT-50	500



- Material: Nylon 66 (UL)
- Flame Class: 94V-2/94V-0
- Color: Black
- Unit: mm

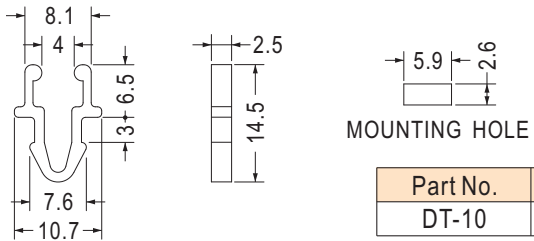

Part No.	Package
DT-10	2000



- Material: Nylon 66 (UL)
- Flame Class: 94V-2/94V-0
- Color: Black
- Unit: mm

用途：用於機器之合鈕，方便機器門之開與關。

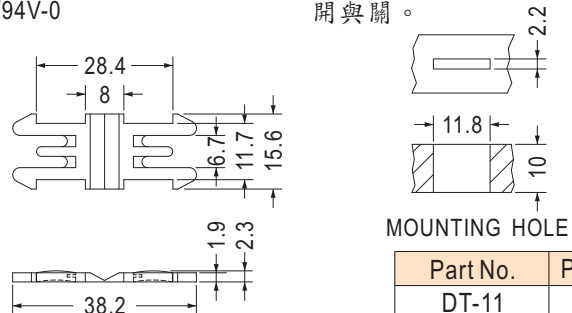

Part No.	Package
DT-11	500



- Material: Nylon 66 (UL)
- Flame Class: 94V-2/94V-0
- Color: Black
- Unit: mm

用途：用於機器之開關門扣，方便機器門之開與關。

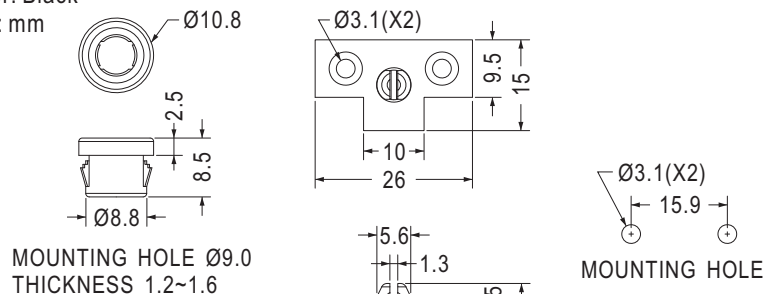

Part No.	Package
DT-48A	1000

Part No.	Package
DT-48B	1000

門扣擋銷 DOOR LOCK TIP

用途：用於機器之開關門扣，方便機器門之開與關。



- Material: Nylon 66 (UL)
- Flame Class: 94V-2/94V-0
- Color: Natural/Black
- Unit: mm

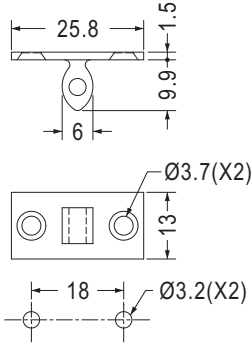

MOUNTING HOLE

Part No.	Package
DTA-42	500

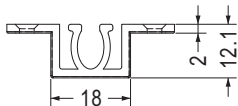
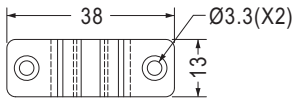

MOUNTING HOLE

- Material: POM
- Color: Natural

Part No.	Package
DT-49	500

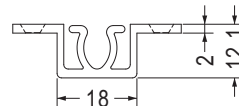
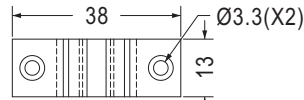

MOUNTING HOLE

- Material: POM (UL)
- Flame Class: 94HB
- Color: Natural

Part No.	Package
DT-42	500



- Material: ABS (UL)
- Flame Class: 94HB
- Color: Natural
- Unit: mm

用途：用於面板固定用。

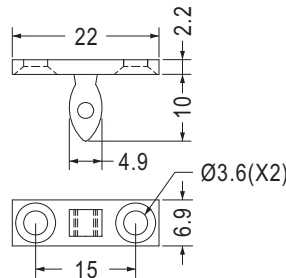

門扣擋梢
DOOR LOCK PIN

Part No.	Package
DT-45A	500

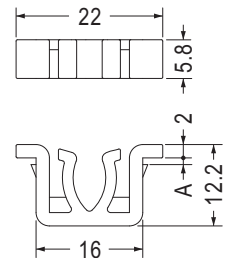

門扣本體
DOOR LOCK BODY

Part No.	A	Package
DT-45B	1.0	500
DT-45BL	1.1	



- Material: POM (UL)
- Flame Class: 94HB
- Color: Natural
- Unit: mm

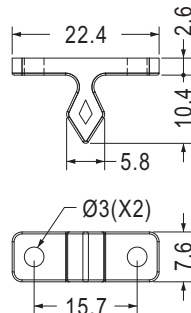

Part No.	Package
DT-46A	500

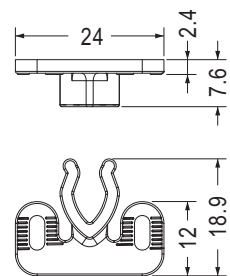

Part No.	Package
DT-46B	500



門扣擋銷 DOOR LOCK TIP



- Material: Nylon 66 (UL)
- Flame Class: 94V-2/94V-0
- Color: Natural/Black
- Unit: mm

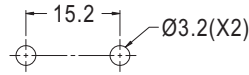
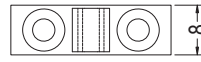
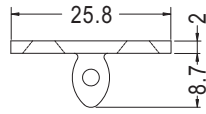

MOUNTING HOLE

Part No.	Package
DT-43A	500

用途：用於面板固定用。

- Material: POM
- Color: Natural
- Unit: mm

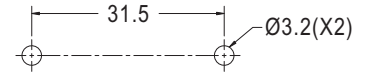
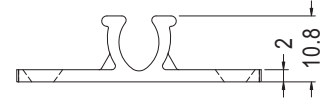
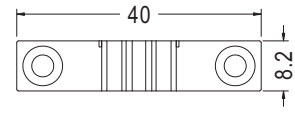

MOUNTING HOLE

Part No.	Package
DT-43B	500

門扣 DOOR LOCK



- Material: Nylon 66 (UL)
- Flame Class: 94V-2/94V-0
- Color: Natural/Black
- Unit: mm

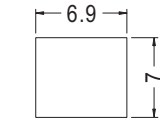
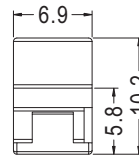
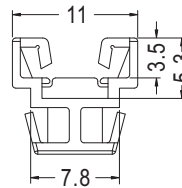

MOUNTING HOLE
THICKNESS 2.0

Part No.	Package
DT-47B	1000

用途：用於機器之開關門扣，方便機器門之開與關，可配合DTA-1使用。

彈簧固定座 SPRING POSITION MOUNT



- Material: Nylon 66 (UL)
- Flame Class: 94V-2/94V-0
- Position Pin Material: POM
- Color: Black
- Unit: mm
- Patented (專利品)

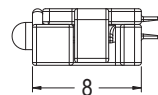
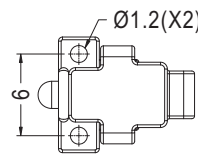
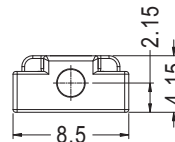

用途：用於旋轉機構角度定位。

Part No.	Part No.	Package
DTB-1F	DTB-1A	1000
	DTB-1B	
	SPG-504	

磁鐵門扣 MAGNET DOOR LOCK



- Material: Nylon 66 (UL)
- Flame Class: 94V-2/94V-0
- Clip Material: SPCC
- Color: Black
- Unit: mm

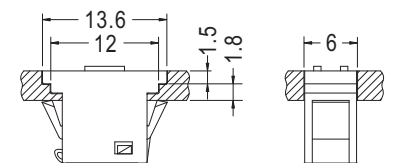
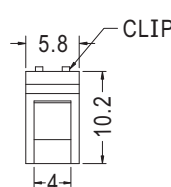
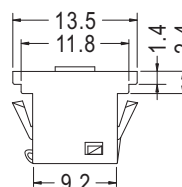

MOUNTING HOLE

Part No.	Package
DTM-1	500

用途：用於機器之開關門扣磁性強，方便機器門之開與關。

磁鐵門扣 MAGNET DOOR LOCK

用途：用於機器之開關門扣磁性強，方便機器門之開與關。



- Material: Nylon 66 (UL)
- Flame Class: 94V-2/94V-0
- Clip Material: SPCC
- Color: Black
- Unit: mm

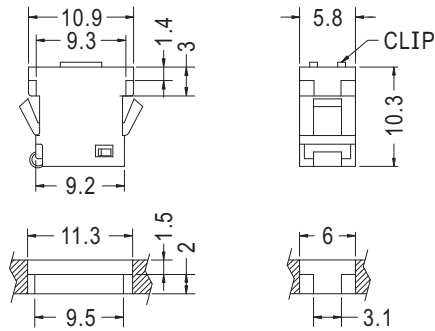

Part No.	Package
DTM-2	500

MOUNTING HOLE

旋轉型門扣 DOOR LOCK

用途：固定於兩片鐵板，一般用於機器的門扣，拆卸方便。



- Material: Nylon 66 (UL)
- Flame Class: 94V-2/94V-0
- Color: Black
- Unit: mm

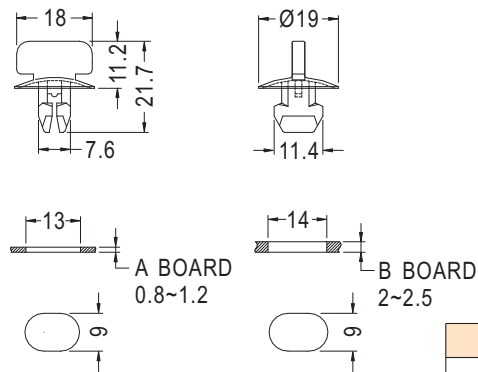

Part No.	Package
TF-1	200

MOUNTING HOLE

十字型插件式固定器 PLUG-IN SWITCH CROSS TYPE

用途：用於零件的扣件。



- Material: POM
- Color: Black
- Unit: mm

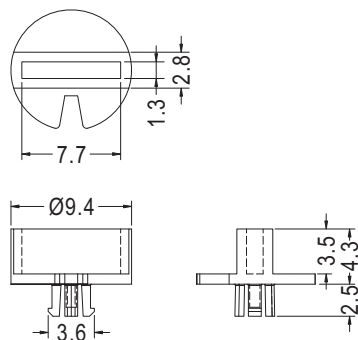

Part No.	Package
EM-349	1000

軌道固定器 RAIL MOUNT

用途：用於軌道的固定。



- Material: Nylon 66 (UL)
- Flame Class: 94V-2/94V-0
- Color: Natural/Black
- Unit: mm

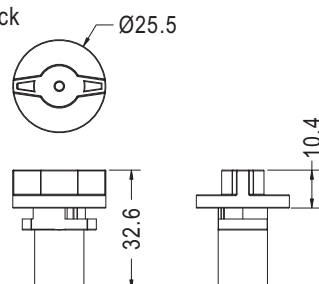

Part No.	Package
EM-710	100

固定扣 SNAP LATCH



- Material: PC (UL)
- Flame Class: 94V-2
- Color: Black
- Unit: mm

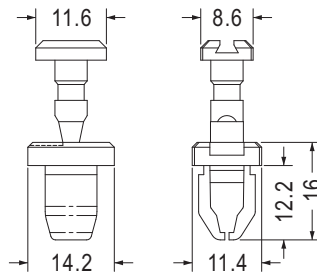

用途：固定於兩片鐵板，一般用於機器
的門扣，拆卸方便。

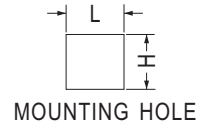
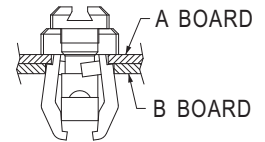

Part No.	Package
TFA-2	500

A Board	MOUNTING HOLE (LxH): 9x9 THICKNESS: 1.2~1.5
B Board	MOUNTING HOLE (LxH): 9.5x9 THICKNESS: 1.2~2.5

螺絲固定座 PLASTIC CONICAL ANCHORS



- Material: Nylon 66 (UL)
- Flame Class: 94V-2/94V-0
- Color: Natural/Black
- Unit: mm
- Drill Size: 3/16(Ø4.8)

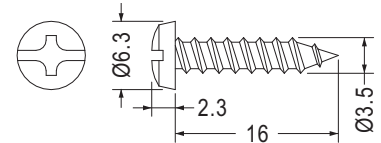
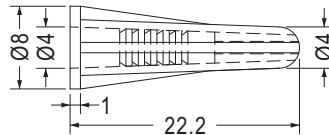

用途：用於螺絲與牆壁固定，結合力強。

Part No.	Color	Package
PCA-1	Natural	1000
PCA-1(R)	Red	

Part No.	Package
STP-3.5	1000

- Material: Steel
- Finish: Nickel Plated

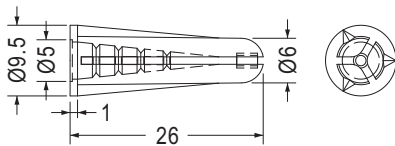

- Drill Size: Ø6.3

Part No.	Package
PCA-4	1000

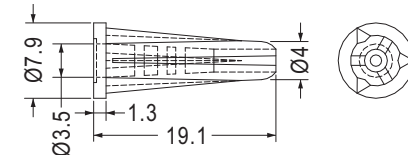

Part No.	Package
PCA-6	1000

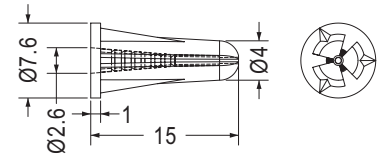

Part No.	Package
PCA-8	1000

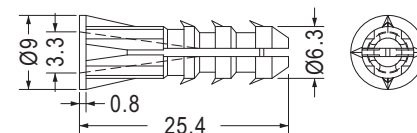

- Material: PP
- Color: Black/Gray
- Drill Size: Ø6.3

Part No.	Package
PCA-2	1000

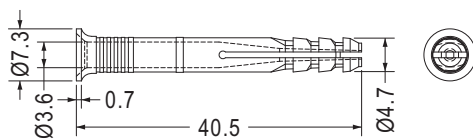

- Drill Size: Ø4.8

Part No.	Package
PCA-5	1000

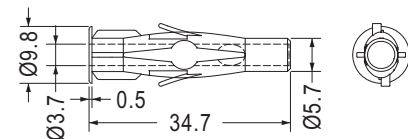

- Color: Natural/Black/Gray
- Drill Size: Ø6.3

Part No.	Package
PCA-7	1000

螺絲固定座 PLASTIC CONICAL ANCHORS

用途：用於螺絲與牆壁固定，結合力強。



- Material: PP
- Color: Natural/Yellow
- Unit: mm
- Drill Size: $\varnothing 6.35$

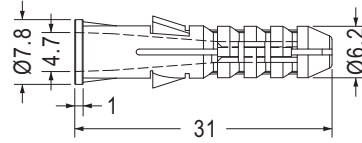

Part No.	Package
PCA-9	1000



- Material: PP
- Color: Natural
- Unit: mm
- Drill Size: $\varnothing 6.3$

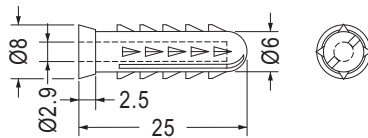

Part No.	Package
PEB3-25	1000

- Material: Nylon 66 (UL)/PP
- Flame Class: 94V-2/94V-0
- Color: Natural/White/Black
- Unit: mm

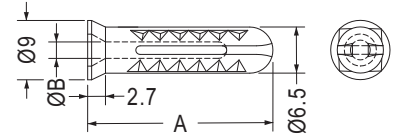

Part No.	A	B	Package
PEC5-28	28.1	2.5	1000
PEC5-30	30.0	3.1	



- Material: PP/PE
- Color: Natural/White
- Unit: mm

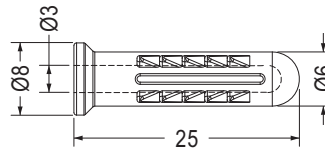

Part No.	Package
PEBR-1	1000



- Material: Nylon 66 (UL)/PP (UL)
- Flame Class: 94HB/94V-2/94V-0
- Color: Natural/White/Black/Gray
- Unit: mm

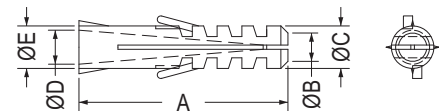

Part No.	A	B	C	D	E	Package
PEB4-20	20.1	2.8	4.0	2.9	4.0	1000
PEB6-25	24.7	3.5	4.8	4.0	5.0	
PEB6-30	29.6	4.0	6.0	4.8	6.0	
PEB6-31	29.6	3.5	6.0	4.0	6.0	

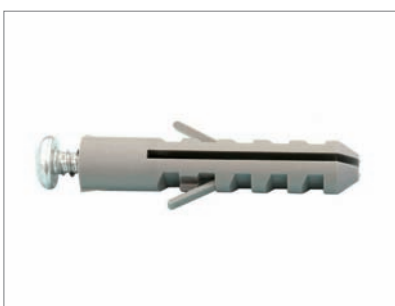

- Material: PP
- Color: Gray
- Unit: mm

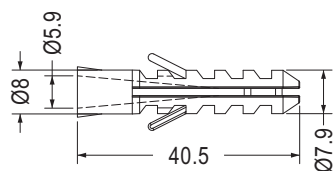

Part No.	Package
PEB5-40.5	1000

可與STP5-32自攻螺絲配合使用

螺絲固定座 PLASTIC CONICAL ANCHORS

用途：用於螺絲與牆壁固定，結合力強。

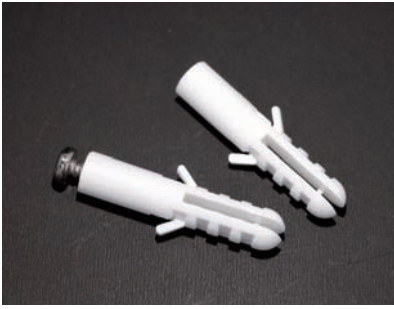

- Material: PP
- Color: Natural
- Unit: mm

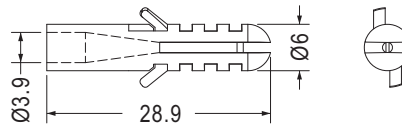

MOUNTING HOLE Ø6.35

Part No.	Package
PEB4-29	1000



- Material: PP/Nylon 66 (UL)
- Flame Class: 94V-2/94V-0
- Color: Natural
- Unit: mm

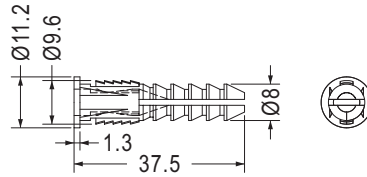

可與STP5-32自攻螺絲配合使用

Part No.	Package
PEB8-38	1000

- Material: Nylon 66 (UL)
- Flame Class: 94V-2/94V-0
- Color: Natural/Black
- Unit: mm

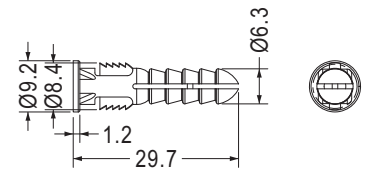

Part No.	Package
PEB4-30	1000

石膏板固定座 PLASTIC CONICAL ANCHORS

用途：用於螺絲與石膏牆壁固定，結合力強。



- Material: PBT (UL)
- Flame Class: 94V-0
- Color: White
- Unit: mm

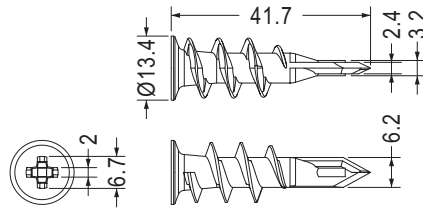

Part No.	Package
WMEZ-1	1000

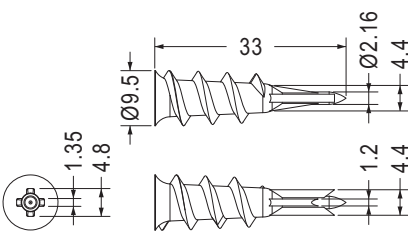

Part No.	Package
WMEZ-2	1000

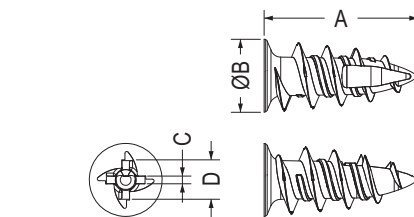

Part No.	A	B	C	D	Package
WMEZ-3	25.0	11.8	1.2	6.35	1000
WMEZ-4	37.6	14.9	2.1	7.0	

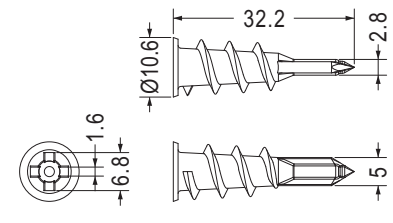

- Material: Nylon 66 (UL)
- Flame Class: 94V-2

Part No.	Package
★ WMEZ-5	1000



- Material: PP
- Color: Natural
- Unit: mm

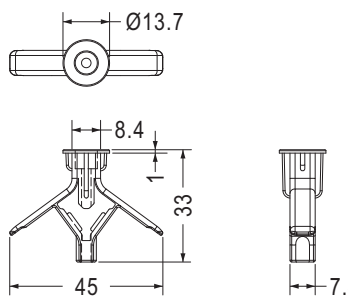

MOUNTING HOLE Ø9.5

Part No.	Package
WMEA-1	1000

防水帽蓋 WATERPROOF CAP

用途：用於零件之防水蓋。



- Material: TPV
- Color: Black
- Unit: mm

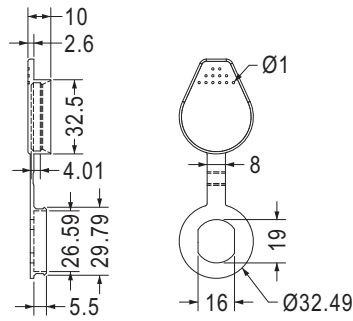

Part No.	Package
EMS-1	100

帽蓋連接帶 CAP WITH CONNECTING TIE

用途：用於零件接頭之防水，中間有連接，避免防塵蓋遺失。



- Material: Nylon 66 (UL)/PE
- Flame Class: 94HB
- Color: Black
- Unit: mm

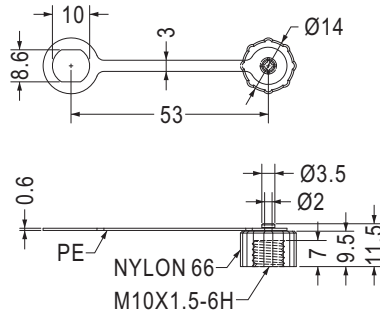

Part No.	Package
CAV-1	500

防水圈 WATERPROOF RING

用途：用於零件之連接，避免配件遺失。



- Material: EPDM
- Color: Black
- Unit: mm

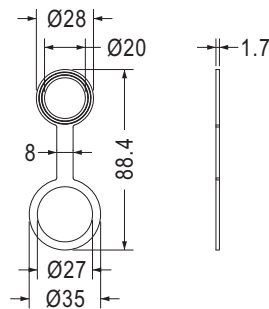

Part No.	Package
TF-568	100

線圈固定座 COIL HOLDER

用途：將鐵粉芯線圈固定於PC板上。

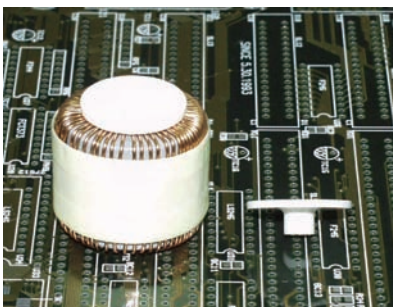

- Material: PBT (UL)
- Flame Class: 94V-0
- Color: Natural
- Unit: mm

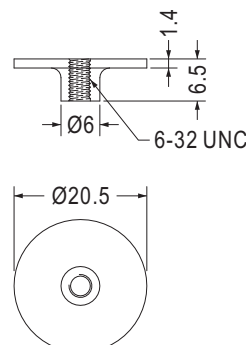

Part No.	Package
TRMH-20	500

風扇支架 FAN FRAME

用途：風扇固定支架。



- Material: TPE (UL)
- Flame Class: 94V-0
- Color: Black
- Unit: mm

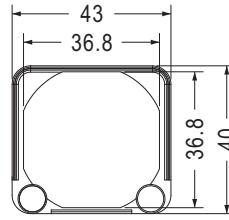

CHASSIS MOUNTING HOLE $\varnothing 4.1$
CHASSIS THICKNESS 1.0

FANS MOUNTING HOLE $\varnothing 3.5$
FANS THICKNESS: T

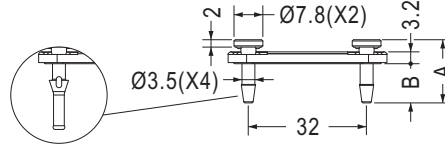

Part No.	A	B	T	Package
FANCA-1	17.1	10.6	6.0	500
★ FANCA-2	24.3	17.8	5.2	250

【 FANCA-2 】

風扇護蓋 REAR FAN PROTECTIVE COVER

用途：用於電腦風扇外框。



- Material: PBT (UL)
- Flame Class: 94V-0
- Color: Black
- Unit: mm

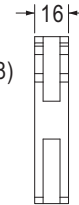
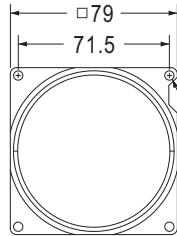

Part No.	Package
FANCS-3	500



- Material: PC (UL)
- Flame Class: 94V-2/94V-0
- Color: Black
- Unit: mm

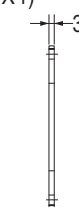
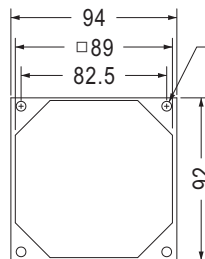

Part No.	Package
FANCV-1	500



- Material: PBT (UL)
- Flame Class: 94V-0
- Color: Black
- Unit: mm

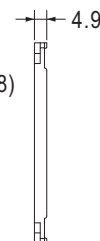
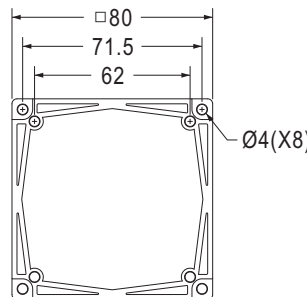

Part No.	Package
FANCV-3	500



- Material: ABS (UL)
- Flame Class: 94V-0
- Color: Black
- Unit: mm

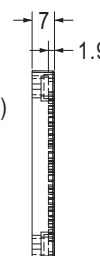
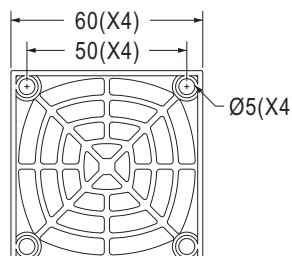

Part No.	Package
FANCV-9	100

風扇防塵座 ANTI-DUST FAN GUARD

用途：用於電腦或儀器風扇之防塵，避免灰塵進入機器內。

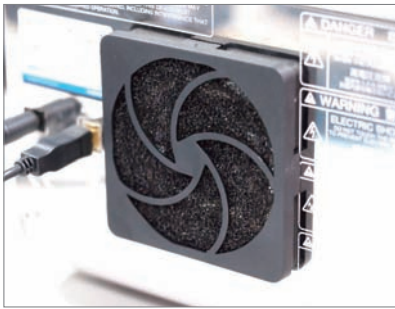

- Material: PC+ABS (UL)
- Flame Class: 94V-0
- Color: Black
- Unit: mm

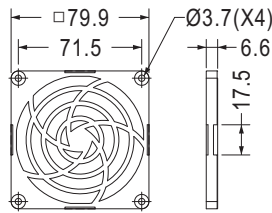

【 FANCV-5A 】

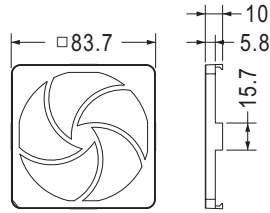

【 FANCV-5B 】

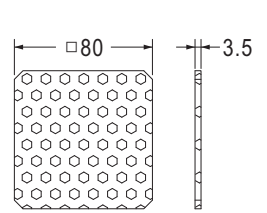

【 FANCV-5C 】

Part No.	Part No.	Package
FANCV-5	FANCV-5A	50
	FANCV-5B	
	FANCV-5C	
此為子母包:內容物包含右方零件		

風扇框護墊 FRAME PAD

用途：用於電腦風扇外框之防震，降低噪音。



- Material: Silicon Rubber
- Color: Black/Transparent
- Unit: mm

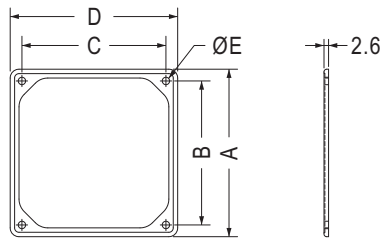

Part No.	A	B	C	D	E	Package
TF-143	94.8	81.5	81.5	94.8	4.2	50
TF-144	122.7	104.8	104.8	122.7	4.0	
TF-147	61.4	49.4	49.4	61.4	4.0	100

7



- Material: Silicon Rubber
- Color: Black
- Unit: mm

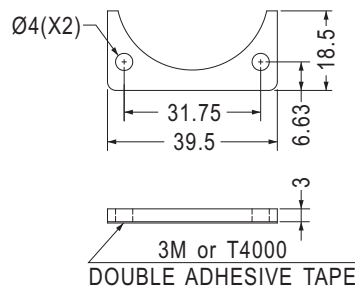

Part No.	Package
TF-018	200

螺絲帽蓋 SCREW CAP

用途：用於螺絲凸出之保護，美觀不刮手，避免不當之拆卸。



- Material: Nylon 66 (UL)
- Flame Class: 94V-2/94V-0
- Color: Natural/Black
- Unit: mm

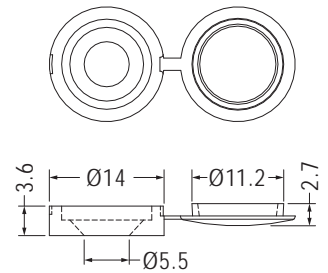
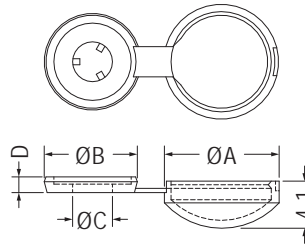

Part No.	A	B	C	D	Package
SCW-1	9.8	8.0	3.3	1.3	1000
SCW-2	13.3	11.6	4.3	1.4	

Part No.	Package
SCW-3	1000



- Material: Nylon 66 (UL)
- Flame Class: 94V-2/94V-0
- Color: Natural/Black
- Unit: mm

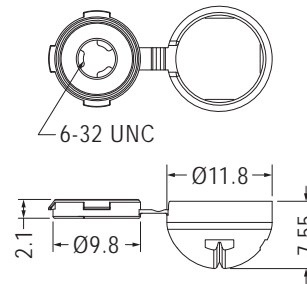

Part No.	Package
SCW-5	1000



- Material: Nylon 66 (UL)
- Flame Class: 94V-2/94V-0
- Color: Natural/Black
- Unit: mm

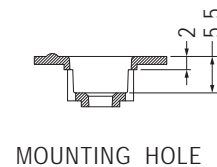
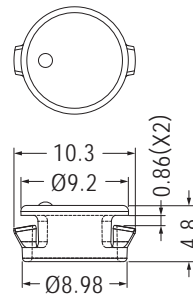

Part No.	Package
SCWA-6	1000

螺絲帽蓋 SCREW BONNET

用途：配合一般螺絲，作為螺絲蓋使用。



- Material: Nylon 66 (UL)
- Flame Class: 94V-2/94V-0
- Color: Natural/Black
- Unit: mm

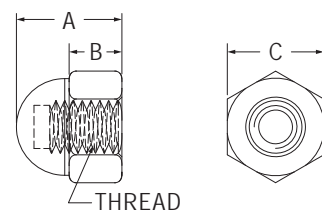
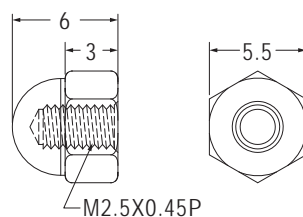

Part No.	Package
MP-2.5	1000

Part No.	A	B	C	Thread	Package
MP-3	6.0	3.0	5.5	M3X0.5P	1000
MP-4	8.0	4.0	7.7	M4X0.7P	
MP-6	11.9	8.5	10.0	M6X1.0P	

螺絲帽蓋 SCREW BONNET

用途：配合一般螺絲，作為螺絲蓋使用。



- Material: Nylon 66 (UL)
- Flame Class: 94V-2/94V-0
- Color: Natural/Black
- Unit: mm

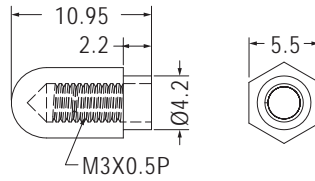

Part No.	Package
MP-5	1000

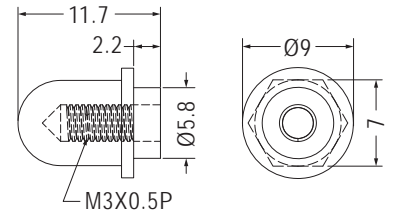

Part No.	Package
MP-26	1000

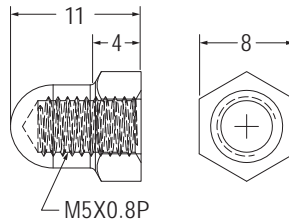

Part No.	Package
MP5-1	1000

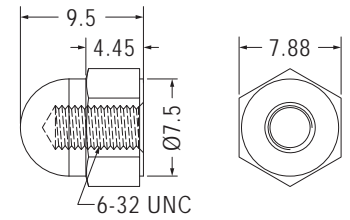

Part No.	Package
MP-632	1000

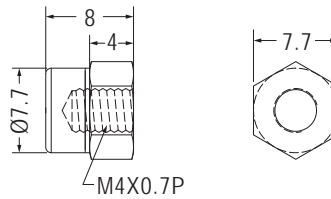

Part No.	Package
MP-4-1	1000

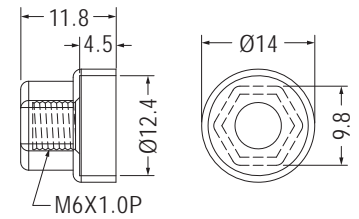

- Material: PBT
- Color: Black

Part No.	Package
MP6-1	1000

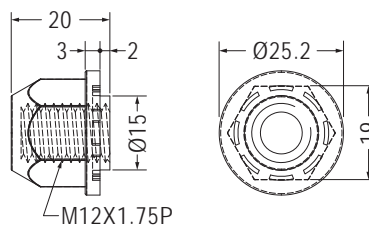
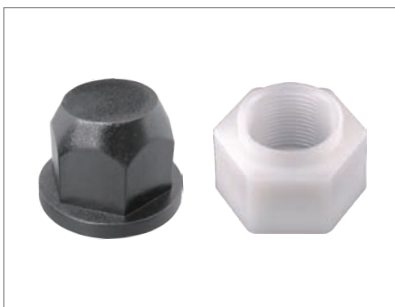

Part No.	Package
MP-12	250

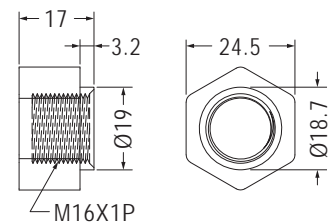

- Material: POM
- Color: Natural

Part No.	Package
★ MP16-1	250

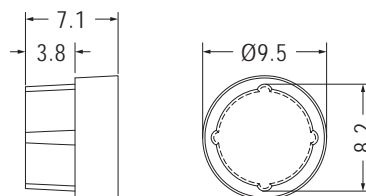

Part No.	Package
SWVB-1	1000

螺絲帽蓋 SCREW BONNET

用途：配合一般螺絲，作為螺絲蓋使用。



- Material: Nylon 66 (UL)
- Flame Class: 94V-2/94V-0
- Color: Natural/Black
- Unit: mm

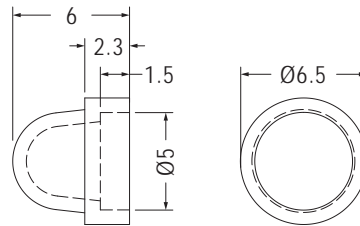

Part No.	Package
SWV-4	1000



- Material: Silicon Rubber
- Color: Black
- Unit: mm

用途：配合一般螺絲M8，作為螺絲蓋使用。

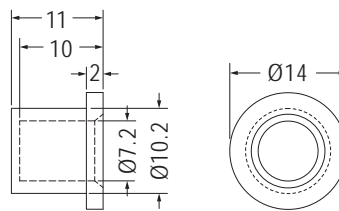

Part No.	Package
TF-250	1000

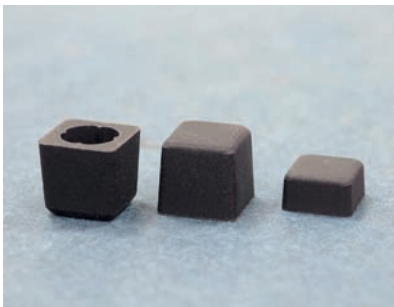

- Material: Silicon Rubber
- Color: Black
- Unit: mm

用途：配合一般螺絲，作為螺絲蓋使用。

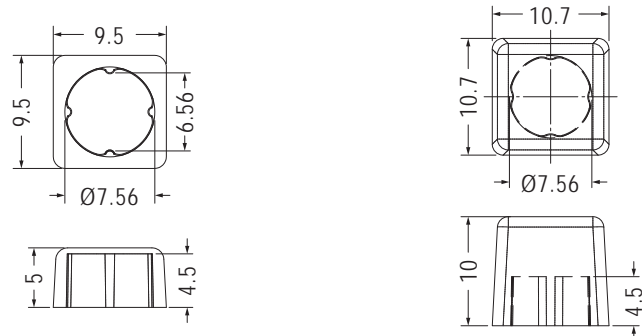

Part No.	Package
EMC-40	1000

Part No.	Package
EMC-41	1000

翼型螺帽 WING NUT

用途：配合一般螺絲或塑膠螺絲使用。



- Material: Nylon 66 (UL)
- Flame Class: 94V-2/94V-0
- Color: Natural/Black
- Unit: mm

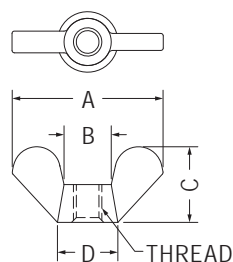

Part No.	A	B	C	D	Thread	Package
SMO-3	15.96	5.0	8.0	6.4	M3X0.5P	1000
SMO-4	21.5	8.0	10.1	10.0	M4X0.7P	
SMO-632	22.0	8.0	10.5	10.0	6-32 UNC	
SMO-832	21.0	8.0	10.0	10.0	8-32 UNC	

塑膠螺帽 NUT

用途：配合一般螺絲或塑膠螺絲使用。

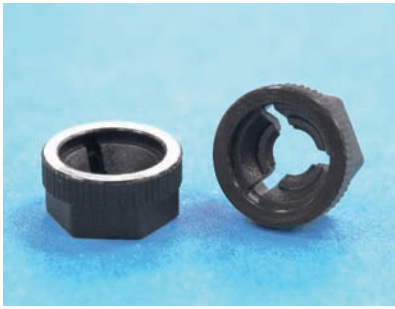

- Material: Nylon 66 (UL)
- Flame Class: 94V-2/94V-0
- Color: Natural/Black
- Unit: mm

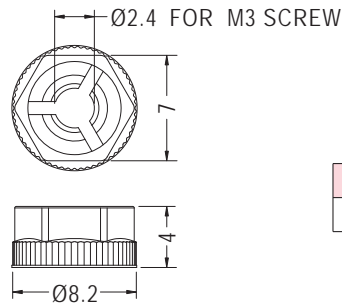

Part No.	Package
MOA3	1000

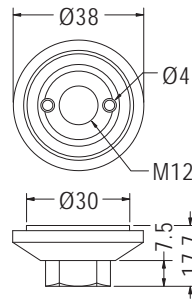

Part No.	Package
CAM-12	100

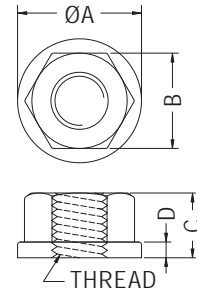
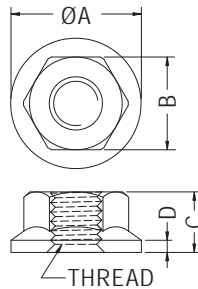

Part No.	A	B	C	D	Thread	Package
MO-3	8.5	5.4	3.2	0.8	M3X0.5P	1000
MO-3-3.7	8.5	5.4	3.7	0.8	M3X0.5P	
MO-4	9.7	6.9	4.5	0.9	M4X0.7P	
MO-632	10.6	7.8	4.2	1.0	6-32 UNC	

Part No.	A	B	C	D	Thread	Package
MO-6G-68	13.0	10.0	6.8	1.65	M6X1.0P	2000
MO-8G-85	17.0	13.0	8.5	1.9	M8X1.25P	1000



- Material: Nylon 66 (UL)/PC (UL)
- Flame Class: 94V-2/94V-0
- Color: Natural
- Unit: mm

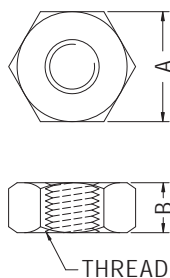

Part No.	A	B	Thread	Package
M-2	3.95	1.4	M2X0.4P	2000
M-2L	3.95	3.0	M2X0.4P	
M-2.5	5.0	2.0	M2.5X0.45P	
M-2.6	5.0	2.0	M2.6X0.45P	
M-3	5.5	2.7	M3X0.5P	
M-3S	5.4	2.4	M3X0.5P	1000
M-3.5	5.9	2.8	M3.5X0.6P	
M-4	6.9	3.3	M4X0.7P	
M-4F	7.0	2.5	M4X0.7P	
M-5	8.0	4.4	M5X0.8P	
M-6	10.0	5.0	M6X1.0P	
S4-40	6.4	2.5	4-40 UNC	1000
S6-32	7.9	3.2	6-32 UNC	

塑膠螺帽 NUT

用途：配合鏡頭調整或塑膠螺絲使用。



- Material: Nylon 66 (UL)
- Flame Class: 94V-2/94V-0
- Color: Natural/Black
- Unit: mm

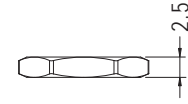
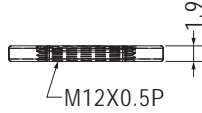
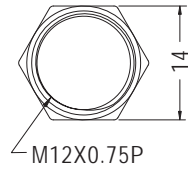
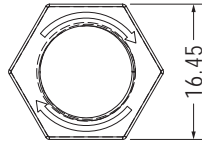

Part No.	Package
M12-2	2000

Part No.	Package
MOC-12	1000



- Material: Nylon 66 (UL)
- Flame Class: 94V-2/94V-0
- Color: Natural/Black
- Unit: mm

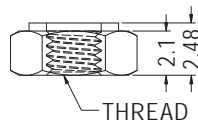

用途：配合一般螺絲或塑膠螺絲使用。

Part No.	Thread	Package
MOB-2.5	M2.5X0.45P	1000
MOB-2.6	M2.6X0.45P	

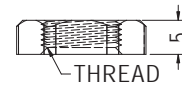
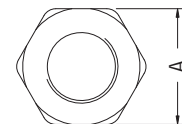
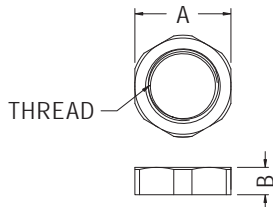

Part No.	A	B	Thread	Package
MOPG-7	17.1	5.0	PG7	1000
MOPG-9	22.0	5.1	PG9	
MOPG-11	24.0	6.1	PG11	
MOPG-13.5	27.2	6.1	PG13.5	

Part No.	A	Thread	Package
M-10	17.0	M10X1.5P	500
MO-12	17.9	M12X1.5P	1000



- Material: Nylon 66 (UL)/PP
- Flame Class: 94V-2/94V-0
- Color: Natural/Black
- Unit: mm

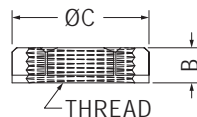
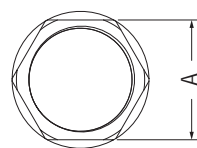

Part No.	A	B	C	Thread	Package
MO-8-1	12.0	5.0	13.0	M8X1.0P	1000
MO-13	14.0	4.1	16.0	M13X1.0P	
MO-25.4	38.2	11.7	42.2	PF1-11	100
MO-32L	36.6	8.2	41.15	M32X1.5P	500

塑膠螺帽 NUT

用途：配合一般螺絲或塑膠螺絲使用。



- Material: Nylon 66 (UL)
- Flame Class: 94V-2/94V-0
- Color: Natural/Black
- Unit: mm

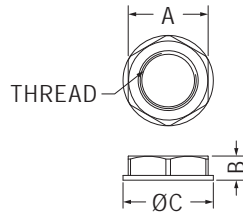

Part No.	A	B	C	Thread	Package
MO-16	22.0	6.6	24.7	M16X1.5P	1000
MO-20	27.0	6.6	29.8	M20X1.5P	500
MO-25	33.0	8.5	36.2	M25X1.5P	
MO-25-1	33.0	6.6	35.4	M25X1.5P	100
MO-32	41.0	7.6	46.4	M32X1.5P	

塑膠螺絲 SCREW

用途：用於固定需絕緣之零件，重量輕，耐腐蝕。

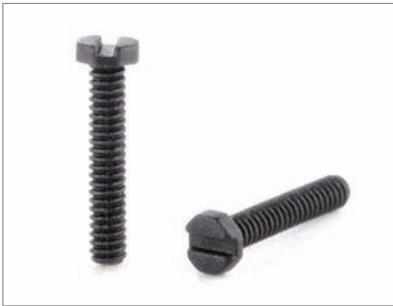

- Material: Nylon 66 (UL)+GF
- Flame Class: 94HB
- Color: Black
- Unit: mm

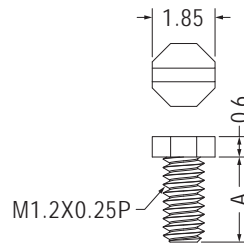

Part No.	A	Package
MI1.2-2.5NGF	2.5	1000
MI1.2-3NGF	3.0	
MI1.2-4NGF	4.0	
MI1.2-5NGF	5.0	
MI1.2-6NGF	6.0	

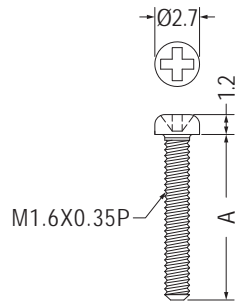

Part No.	A	Package
M1.6-3	3.0	1000
M1.6-4	4.0	
M1.6-4.5	4.5	
M1.6-5	5.0	
M1.6-6	6.0	
M1.6-7	7.0	
M1.6-8	8.0	
M1.6-9	9.0	
M1.6-10	10.0	



- Material: Nylon 66 (UL)
- Flame Class: 94V-2/94V-0
- Color: Natural/Black
- Unit: mm

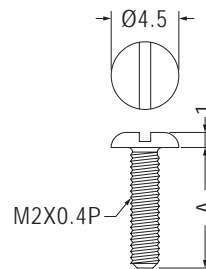

Part No.	A	Package
MI2-6	6.0	1000
MI2-8	8.0	
MI2-10	10.0	
MI2-12	12.0	

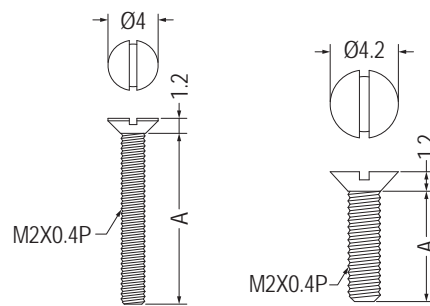

【 MI2-14.8F 】

Part No.	A	Package
MI2-3.8F	3.8	1000
MI2-4.8F	4.8	
MI2-5.8F	5.8	
MI2-6.8F	6.8	
MI2-7.8F	7.8	
MI2-8.8F	8.8	
MI2-9.8F	9.8	
MI2-14.8F	14.8	

塑膠螺絲 SCREW

用途：用於固定需絕緣之零件，重量輕，耐腐蝕。

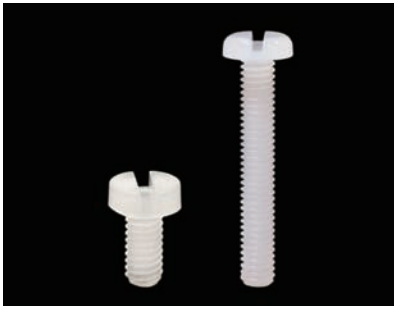

- Material: Nylon 66 (UL)
- Flame Class: 94V-2/94V-0
- Color: Natural/Black
- Unit: mm

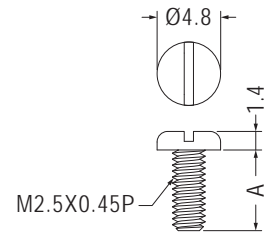
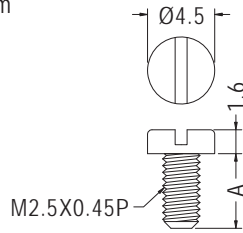

Part No.	A	Package
MI2.5-5	5.0	2000
MI2.5-12	12.0	

Part No.	A	Package
MI2.5-4	4.0	2000
★MI2.5-12S	12.0	
MI2.5-16	16.0	

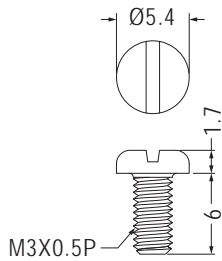

Part No.	Package
MI3-6R	1000

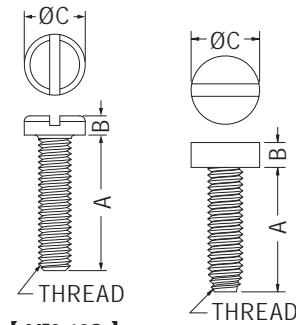

【 MI3-12S 】

Part No.	A	B	C	Thread	Package
★MI3-3	3.0	2.0	5.5	M3X0.5P	1000
MI3-5	5.0	2.0	5.5	M3X0.5P	
MI3-6	6.0	2.0	5.5	M3X0.5P	
MI3-8	8.0	2.0	5.5	M3X0.5P	
MI3-10	10.0	2.0	5.5	M3X0.5P	
MI3-12	12.0	2.0	5.5	M3X0.5P	
MI3-12S	12.0	1.7	5.4	M3X0.5P	
MI4-7	7.0	2.7	7.0	M4X0.7P	
MI4-10	10.0	2.7	7.0	M4X0.7P	



- Material: PEEK (UL)
- Flame Class: 94V-0
- Color: Natural
- Unit: mm

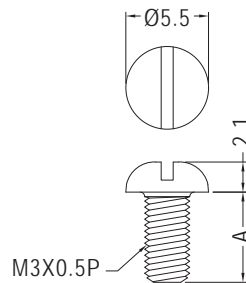

Part No.	A	Package
MI3-4PK	4.0	1000
MI3-5PK	5.0	
MI3-6PK	6.0	
MI3-8PK	8.0	
MI3-10PK	10.0	
MI3-12PK	12.0	
MI3-14PK	14.0	
MI3-15PK	15.0	
MI3-17PK	17.0	
MI3-18PK	18.0	
MI3-20PK	20.0	
MI3-25PK	25.0	
MI3-30PK	30.0	



- Material: PEEK (UL)
- Flame Class: 94V-0
- Color: Natural
- Unit: mm

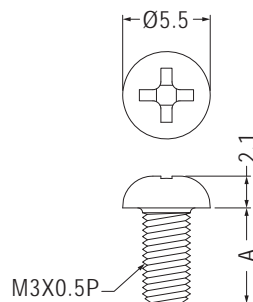

Part No.	A	Package
M3-4PK	4.0	2000
M3-5PK	5.0	
M3-6PK	6.0	
M3-8PK	8.0	1000
M3-10PK	10.0	
M3-12PK	12.0	
M3-14PK	14.0	
M3-15PK	15.0	
M3-17PK	17.0	
M3-18PK	18.0	
M3-20PK	20.0	
M3-25PK	25.0	
M3-30PK	30.0	

塑膠螺絲 SCREW

用途：用於固定需絕緣之零件，重量輕，耐腐蝕。



- Material: Nylon 66 (UL)/PC (UL)
- Flame Class: 94V-2/94V-0
- Color: Natural
- Unit: mm

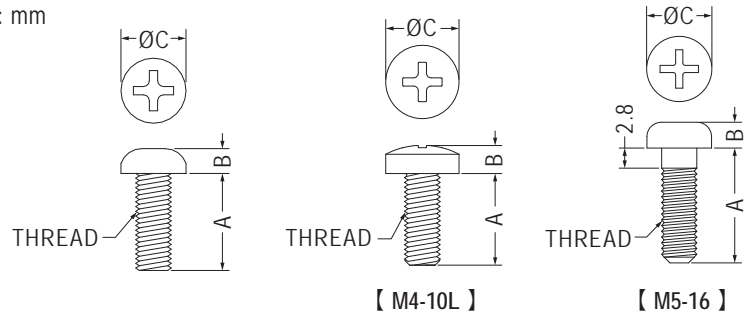

Part No.	A	B	C	Thread	Package
M2-3	3.0	1.4	3.3	M2X0.4P	2000
M2-4	4.0	1.4	3.3	M2X0.4P	
M2-5	5.0	1.4	3.3	M2X0.4P	
M2-6	6.0	1.4	3.3	M2X0.4P	
M2-6.5	6.5	1.4	3.3	M2X0.4P	
M2-8	8.0	1.4	3.3	M2X0.4P	
M2-10	10.0	1.4	3.3	M2X0.4P	
M2-12	12.0	1.4	3.3	M2X0.4P	
M2-15	15.0	1.4	3.3	M2X0.4P	
M2.5-4	4.0	1.5	4.3	M2.5X0.45P	
M2.5-5	5.0	1.5	4.3	M2.5X0.45P	
M2.5-6	6.0	1.5	4.3	M2.5X0.45P	
M2.5-8	8.0	1.5	4.3	M2.5X0.45P	
M2.5-10	10.0	1.5	4.3	M2.5X0.45P	
M2.5L-13	13.0	1.5	6.3	M2.5X0.45P	
M2.6-4	4.0	1.5	4.3	M2.6X0.45P	
M2.6-5	5.0	1.5	4.3	M2.6X0.45P	
M2.6-6	6.0	1.5	4.3	M2.6X0.45P	
M2.6-8	8.0	1.5	4.3	M2.6X0.45P	
M2.6-10	10.0	1.5	4.3	M2.6X0.45P	
M3-4	4.0	2.1	5.5	M3X0.5P	1000
M3-5	5.0	2.1	5.5	M3X0.5P	
M3-6	6.0	2.1	5.5	M3X0.5P	
M3-8	8.0	2.1	5.5	M3X0.5P	
M3-10	10.0	2.1	5.5	M3X0.5P	
M3-12	12.0	2.1	5.5	M3X0.5P	
M3-14	14.0	2.1	5.5	M3X0.5P	
M3-15	15.0	2.1	5.5	M3X0.5P	
M3-17	17.0	2.1	5.5	M3X0.5P	
M3-18	18.0	2.1	5.5	M3X0.5P	

Part No.	A	B	C	Thread	Package
M3-20	20.0	2.1	5.5	M3X0.5P	1000
M3-25	25.0	2.1	5.5	M3X0.5P	
M3-30	30.0	2.1	5.5	M3X0.5P	
★M4-5	5.0	2.5	7.0	M4X0.7P	
M4-6	6.0	2.5	7.0	M4X0.7P	
M4-8	8.0	2.5	7.0	M4X0.7P	
M4-10	10.0	2.5	7.0	M4X0.7P	
★M4-10L	10.0	3.1	8.0	M4X0.7P	
M4-12	12.0	2.5	7.0	M4X0.7P	
M4-14	14.0	2.5	7.0	M4X0.7P	
M4-16	16.0	2.5	7.0	M4X0.7P	
M4-20	20.0	2.5	7.0	M4X0.7P	
M4-25	25.0	2.5	7.0	M4X0.7P	
M4-30	30.0	2.5	7.0	M4X0.7P	
M4-35	35.0	2.5	7.0	M4X0.7P	
★M5-16	16.0	3.6	9.1	M5X0.8P	
M5-20	20.0	3.6	9.1	M5X0.8P	
R440-4S	4.75	1.8	5.8	4-40 UNC	2000
R440-6	6.4	2.4	5.2	4-40 UNC	
R440-7	7.0	2.4	5.2	4-40 UNC	
R440-8	8.0	2.4	5.2	4-40 UNC	
R440-9	9.5	2.4	5.2	4-40 UNC	1000
R440-12	12.7	2.4	5.2	4-40 UNC	
R440-15	15.5	2.4	5.2	4-40 UNC	
R632-6	6.35	2.5	6.7	6-32 UNC	2000
R632-8	8.0	2.5	6.7	6-32 UNC	
R632-9	9.5	2.5	6.7	6-32 UNC	
R632-12	12.7	2.5	6.7	6-32 UNC	1000
R632-15	15.9	2.5	6.7	6-32 UNC	
R632-19	19.1	2.5	6.7	6-32 UNC	



- Material: PEEK (UL)
- Flame Class: 94V-0
- Color: Natural
- Unit: mm

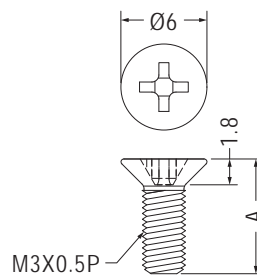

Part No.	A	Package
M3-4FPK	4.0	1000
M3-5FPK	5.0	
M3-6FPK	6.0	
M3-8FPK	8.0	
M3-10FPK	10.0	
M3-12FPK	12.0	
M3-14FPK	14.0	
M3-15FPK	15.0	
M3-17FPK	17.0	
M3-18FPK	18.0	
M3-20FPK	20.0	
M3-25FPK	25.0	
M3-30FPK	30.0	

塑膠螺絲 SCREW

用途：用於固定需絕緣之零件，重量輕，耐腐蝕。



- Material: Nylon 66 (UL)/PC (UL)
- Flame Class: 94V-2/94V-0
- Color: Natural/Black
- Unit: mm

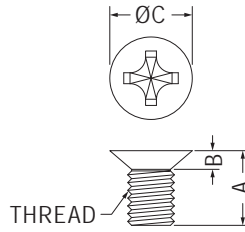

Part No.	A	B	C	Thread	Package
M2-4.5F	4.5	1.2	3.6	M2X0.4P	2000
M2-5.5F	5.5	1.2	3.6	M2X0.4P	
M2-6.5F	6.5	1.2	3.6	M2X0.4P	
M2-7.5F	7.5	1.2	3.6	M2X0.4P	
M2-8.5F	8.5	1.2	3.6	M2X0.4P	
M2.5-6F	6.0	1.5	4.6	M2.5X0.45P	
M2.5-8F	8.0	1.5	4.6	M2.5X0.45P	
M3-4.2F	4.2	1.7	6.0	M3X0.5P	1000
M3-5F	4.8	1.2	5.3	M3X0.5P	
M3-5.3F	5.0	1.6	5.3	M3X0.5P	
M3-6F	6.0	1.6	5.6	M3X0.5P	

Part No.	A	B	C	Thread	Package
M3-8F	8.0	1.6	5.6	M3X0.5P	1000
M3-10F	10.0	1.6	5.6	M3X0.5P	
M3-12F	12.0	1.6	5.6	M3X0.5P	
M3-14F	14.0	1.6	5.6	M3X0.5P	
M4-8F	8.0	2.0	7.6	M4X0.7P	
M4-10F	10.0	2.0	7.6	M4X0.7P	
M4-12F	12.0	2.0	7.6	M4X0.7P	
M4-14F	14.0	2.0	7.6	M4X0.7P	
M4-16F	16.0	2.0	7.6	M4X0.7P	
M4-18F	18.0	2.7	7.65	M4X0.7P	
M5-15F	14.8	2.5	9.1	M5X0.8P	



- Material: Nylon 66 (UL)
- Flame Class: 94V-2/94V-0
- Color: Natural/Black
- Unit: mm

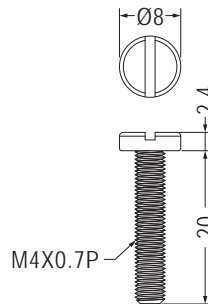

Part No.	Package
MIL4-20	1000



- Material: Nylon 66 (UL)/PC (UL)
- Flame Class: 94V-2/94V-0
- Color: Natural
- Unit: mm

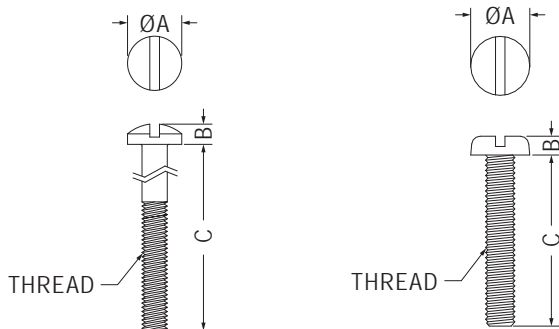

【 S632-25, S632-28 】

Part No.	A	B	C	Thread	Package
M3.5-10	6.9	2.2	10.0	M3.5X0.6P	1000
M3.5-15	6.9	2.2	15.0	M3.5X0.6P	
M3.5-20	6.9	2.2	20.0	M3.5X0.6P	
M3.5-25	6.9	2.2	25.0	M3.5X0.6P	
M3.5-30	6.9	2.2	30.0	M3.5X0.6P	
S440-6	5.2	2.1	6.4	4-40 UNC	2000
S440-8	5.2	2.1	8.0	4-40 UNC	
S440-9	5.2	2.1	9.5	4-40 UNC	
S440-12	5.2	2.1	12.7	4-40 UNC	1000
S440-15	5.2	2.1	15.5	4-40 UNC	
S632-6	6.7	2.5	6.35	6-32 UNC	2000
S632-8	6.7	2.5	8.0	6-32 UNC	
S632-9	6.7	2.5	9.5	6-32 UNC	
S632-12	6.7	2.5	12.7	6-32 UNC	1000
S632-15	6.7	2.5	15.9	6-32 UNC	
S632-19	6.7	2.5	19.1	6-32 UNC	
S632-25	6.7	2.5	25.4	6-32 UNC	
S632-28	6.7	2.5	28.0	6-32 UNC	

塑膠螺絲 SCREW

用途：用於固定需絕緣之零件，重量輕，耐腐蝕。



- Material: Nylon 66 (UL)
- Flame Class: 94V-2/94V-0
- Color: Natural/Black
- Unit: mm

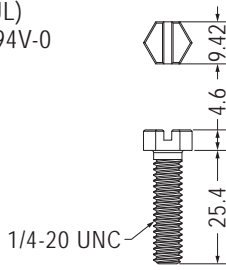

Part No.	Package
MI420-25.4	1000

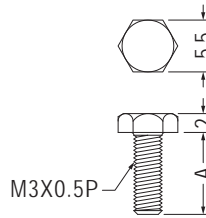

Part No.	A	Package
STM3-4	4.0	2000
STM3-6	6.0	
STM3-8	8.0	
STM3-10	10.0	
STM3-12	12.0	

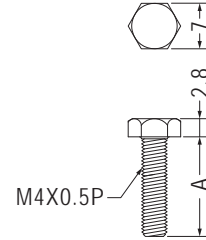

Part No.	A	Package
STM4-6	6.0	2000
STM4-8	8.0	
STM4-10	10.0	
STM4-12	12.0	

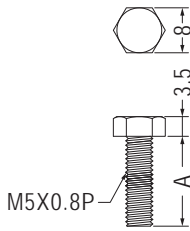

Part No.	A	Package
STM5-16	16.0	1000
STM5-25	25.0	

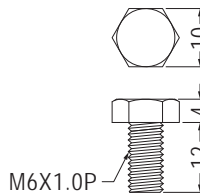

Part No.	Package
STM6-12	2000

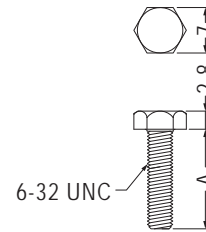

Part No.	A	Package
STM632-6	6.35	2000
STM632-8	8.0	
STM632-9	9.5	
STM632-12	12.7	

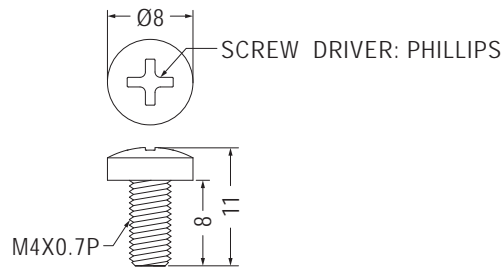

Part No.	Package
M4-8L	1000

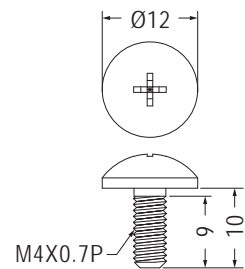

Part No.	Package
M4-9NBD	1000

- Material: PC (UL)
- Flame Class: 94V-2
- Color: Transparent
- Unit: mm

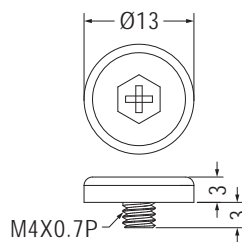

Part No.	Package
MRL4-3	1000

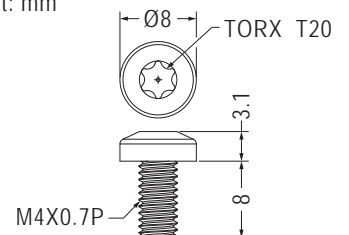

Part No.	Package
★MRT-8	1000

塑膠螺絲 SCREW

用途：用於固定需絕緣之零件，重量輕，耐腐蝕。



- Material: PC (UL)
- Flame Class: 94V-2/94V-0
- Color: Transparent
- Unit: mm

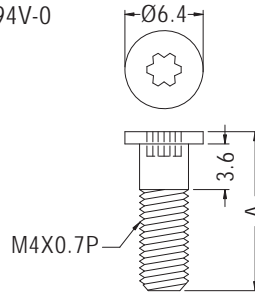

Part No.	A	Package
MR4-9.5	9.5	1000
MR4-12	12.0	
MR4-20	20.0	



- Head Material: Nylon 66 (UL)+GF
- Head Flame Class: 94V-0
- Color: Black
- Unit: mm

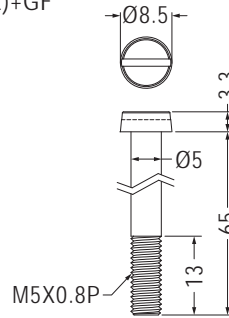

Part No.	Package
M5A-65	250



- Material: PC (UL)
- Flame Class: 94V-2/94V-0
- Color: Transparent
- Unit: mm

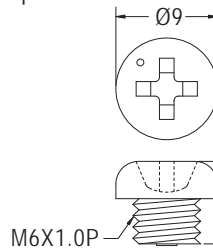

Part No.	Package
M6-4	1000

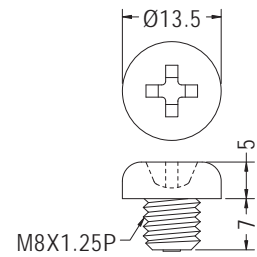

- Material: Nylon 66 (UL)
- Color: Natural/Black

Part No.	Package
M8-7	1000



- Material: PC (UL)
- Flame Class: 94V-2/94V-0
- Color: Transparent
- Unit: mm

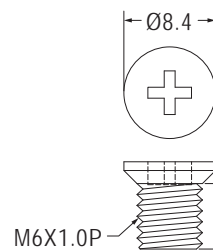

Part No.	Package
M6-8F	500

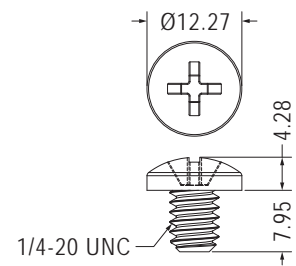

- Material: POM
- Color: Black

Part No.	Package
RU1420-8	500



- Material: PE
- Color: Black
- Unit: mm

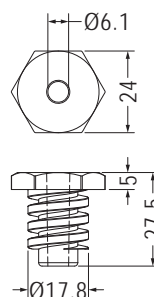

Part No.	Package
EM-528	500

塑膠螺絲 SCREW

用途：用於汽車點菸器插座之固定。



- Material: PC (UL)
- Flame Class: 94V-2/94V-0
- Color: Black
- Unit: mm

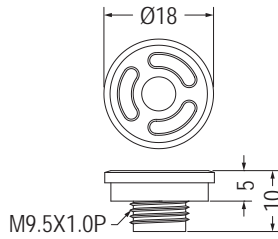

Part No.	Package
ATFF-1	1000



- Material: PP (UL)
- Flame Class: 94HB
- Color: Black/White
- Unit: mm

用途：用於零件、紙張及PC板之固定。

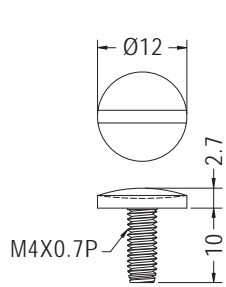

Part No.	Package
KSM-1A	1000

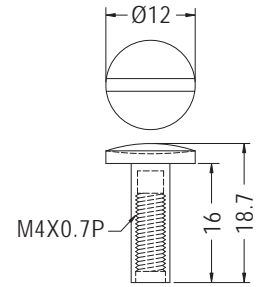

Part No.	Package
KSM-1B	1000

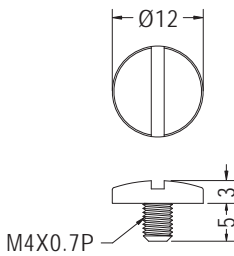

- Material: PE
- Color: Black/White

Part No.	Package
KSM4-5M	1000

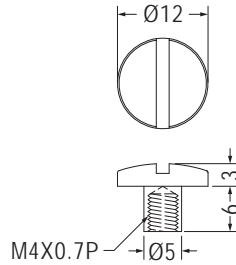

- Material: PE
- Color: Black/White

Part No.	Package
KSM4-6F	1000

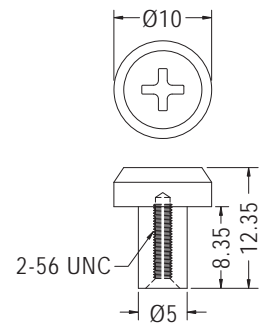

- Material: Nylon 66 (UL)
- Flame Class: 94V-2/94V-0
- Color: Natural/Black

Part No.	Package
KSC256-8.4F	2000



- Material: Nylon 66 (UL)
- Flame Class: 94V-2/94V-0
- Color: Natural/Black
- Unit: mm

用途：用於固定需絕緣之零件，重量輕，耐腐蝕。

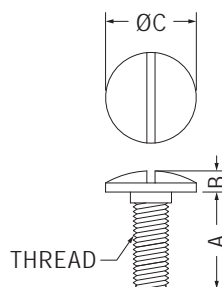

Part No.	A	B	C	Thread	Package
MIA6-16	16.0	3.5	15.0	M6X1.0P	1000
MIA8-20	20.0	5.0	18.5	M8X1.25P	500

翼型螺絲 WING BOLT



- Material: Nylon 66 (UL)
- Flame Class: 94V-2/94V-0
- Color: Natural/Black
- Unit: mm

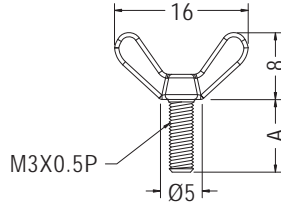

Part No.	A	Package
SM3-6	6.0	2000
SM3-8	8.0	
SM3-10	10.0	
SM3-12	12.0	
SM3-12	12.0	

用途：用於固定需絕緣之零件，重量輕，耐腐蝕。

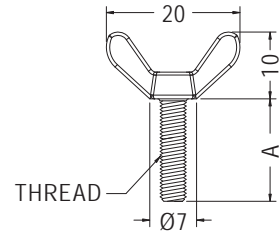

Part No.	A	Thread	Package
SM4-6	6.0	M4X0.7P	2000
SM4-8	8.0	M4X0.7P	
SM4-10	10.0	M4X0.7P	
SM4-12	12.0	M4X0.7P	
SM632-6	6.35	6-32 UNC	
SM632-8	8.0	6-32 UNC	
SM632-9	9.5	6-32 UNC	
SM632-12	12.7	6-32 UNC	

塑膠螺絲 SCREW



- Material: PC (UL)
- Flame Class: 94V-2/94V-0
- Color: Transparent
- Unit: mm

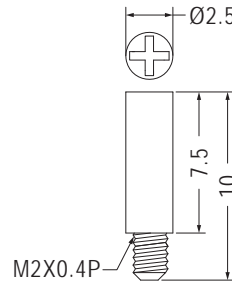

Part No.	Package
MUS2-10	2000

用途：用於固定需絕緣之零件，重量輕，耐腐蝕。

止付螺絲 SET SCREW



- Material: PC (UL)
- Flame Class: 94V-2/94V-0
- Color: Black
- Unit: mm

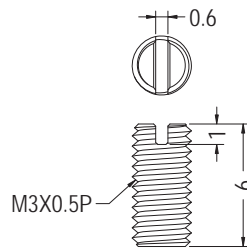

Part No.	Package
THRI3-6	2000

用途：做為螺絲之固定，絕緣，重量輕，耐腐蝕。

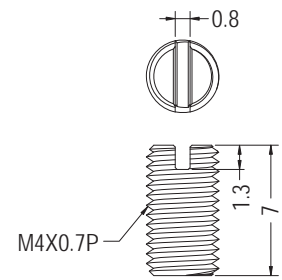

Part No.	Package
THRI4-7	2000



- Material: Nylon 66 (UL)
- Flame Class: 94V-2/94V-0
- Color: Natural/Black
- Unit: mm

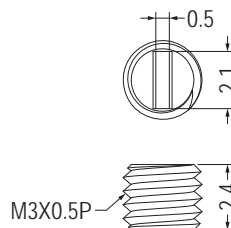

Part No.	Package
THRIA3-2.4	2000

止付螺絲 SET SCREW

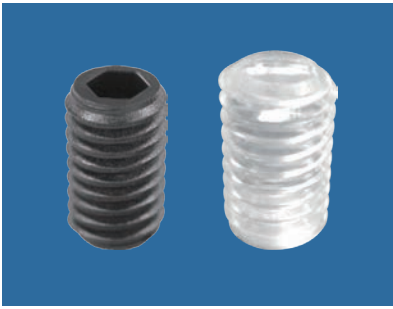

- Material: Nylon 66 (UL)
- Flame Class: 94V-2/94V-0
- Color: Natural/Black
- Unit: mm

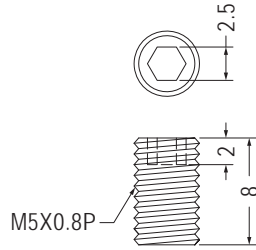

Part No.	Package
THR5-8	2000

用途：做為螺絲之固定，絕緣，重量輕，耐腐蝕。

- Material: PC (UL)
- Flame Class: 94V-2/94V-0
- Color: Transparent
- Unit: mm

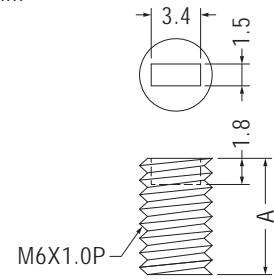

Part No.	A	Package
THRI6-6	6.0	2000
THRI6-8	8.0	
THRI6-10	10.0	

手轉螺母 HAND SPIN NUT



- Material: PC+ABS (UL)
- Flame Class: 94V-2/94V-0
- Color: Black
- Unit: mm

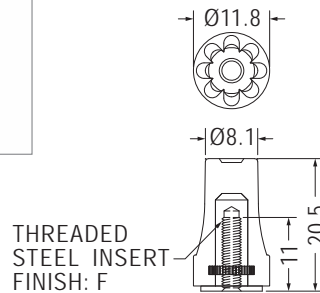

THREADED STEEL INSERT
FINISH: F

用途：用於外殼及零組件之固定，可手轉，不需工具，方便不脫落。

Part No.	F	Thread	Package
GPM3-20	Zinc Plated	M3X0.5P	1000
GPM4-20	Nickel Plated	M4X0.7P	
GPM632-20	Zinc Plated/ Nickel Plated	6-32 UNC	

手轉螺絲 THUMB SCREW



- Material: Nylon 66 (UL)
- Flame Class: 94V-2/94V-0
- Color: Black
- Unit: mm

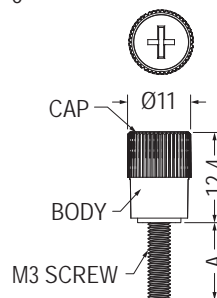

用途：用於外殼及零組件之固定，可手轉，不需工具，方便不脫落。

Part No.	A	Package
HASW3-8	5.0	1000
HASW3-9	6.0	
HASW3-13	10.0	
HASW3-18	15.0	
HASW3-23	20.0	
HASW3-28	25.0	
HASW3-33	30.0	

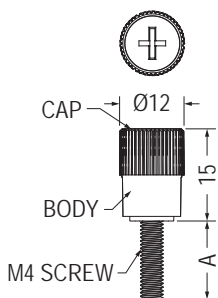

Part No.	A	Package
HASW4-8	5.0	1000
HASW4-13	10.0	
HASW4-18	15.0	
HASW4-23	20.0	
HASW4-28	25.0	
HASW4-33	30.0	

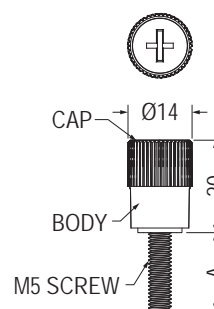

Part No.	A	Package
HASW5-10	7.0	1000
HASW5-15	12.0	
HASW5-20	17.0	
HASW5-25	22.0	
HASW5-30	27.0	
HASW5-35	32.0	
HASW5-40	37.0	
HASW5-45	42.0	
HASW5-50	47.0	

手轉螺絲 THUMB SCREW

用途：螺絲式，固定於機殼。



- Head Material: PC+ABS (UL)
- Head Flame Class: 94V-2/94V-0
- Color: Black
- Unit: mm

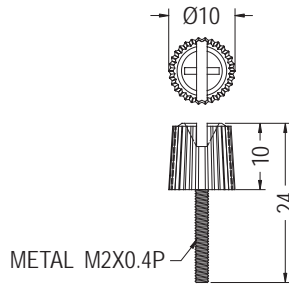

Part No.	Package
GPE2-24	1000

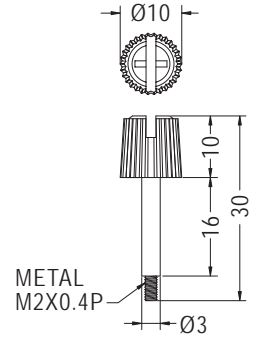

Part No.	Package
GPE2-30	1000



- Plastic Material: PP (UL)
- Flame Class: 94HB
- Color: Black
- Unit: mm

用途：做為螺絲之固定，絕緣，重量輕，耐腐蝕。

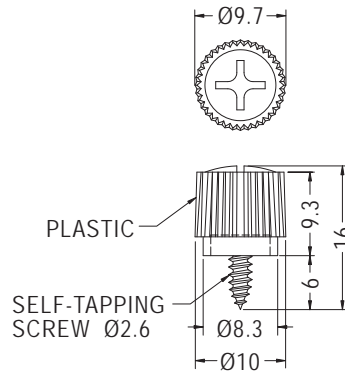

Part No.	Package
GPE2.6-6	1000



- Head Material: PC+ABS (UL)
- Head Flame Class: 94V-2/94V-0
- Color: Black
- Unit: mm

用途：螺絲式，固定於機殼。

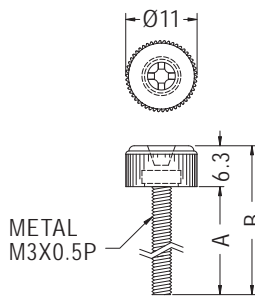

Part No.	A	B	Package
GPE3-5.5	5.5	11.8	1000
GPE3-8	8.0	14.3	
GPE3-15	15.0	21.3	
GPE3-23	23.0	29.3	



- Material: PC+ABS (UL)
- Flame Class: 94V-2/94V-0
- Color: Black
- Unit: mm

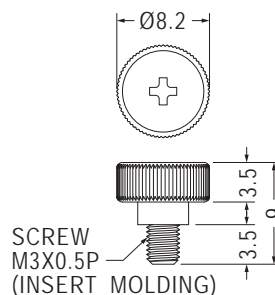

Part No.	Package
GPEE3-3.5	1000

螺絲 SCREW

用途：螺絲式，固定於機殼。



- Head Material: PC+ABS (UL)
- Head Flame Class: 94V-2/94V-0
- Color: Black
- Unit: mm

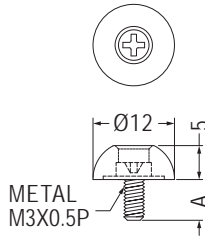

Part No.	A	Package
GPEA3-6BN	6.0	500
GPEA3-8BN	8.0	

手轉螺絲 THUMB SCREW

用途：用於外殼及零組件之固定，可手轉，不需工具，方便不脫落。



- Head Material: PC (UL)
- Head Flame Class: 94V-2/94V-0
- Color: Black
- Unit: mm

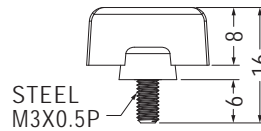
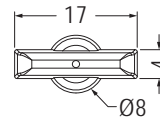

Part No.	Package
GPED3-6	500



- Head Material: PC+ABS (UL)
- Head Flame Class: 94V-2/94V-0
- Color: Natural/Black
- Unit: mm

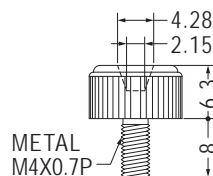
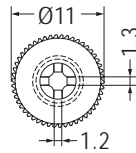

Part No.	Package
GPE4-8	500

用途：螺絲式，固定於機殼。

- Head Material: ABS (UL)
- Head Flame Class: 94HB
- Color: Natural/Black
- Unit: mm

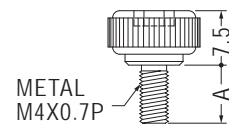
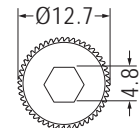

Part No.	A	Package
GPE4-8L	8.0	500
GPE4-12L	12.0	



- Head Material: PP (UL)
- Head Flame Class: 94HB
- Color: Black
- Unit: mm

用途：用於外殼及零組件之固定，可手轉，不需工具，方便不脫落。

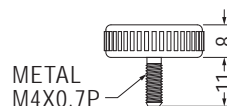
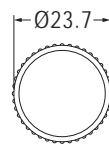

Part No.	Package
GPE4-12-1	200

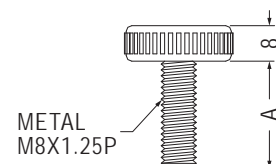
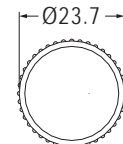

Part No.	A	Package
GPE8-21	13.0	100
GPE8-32	24.7	

手轉螺絲 THUMB SCREW

用途：螺絲式，固定於機殼。



- Head Material: ABS (UL)
- Head Flame Class: 94HB
- Color: Black
- Unit: mm

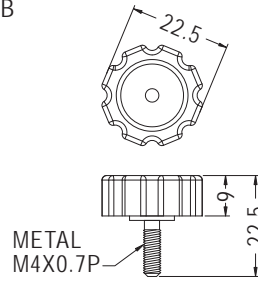

Part No.	Package
GPE4-13.5	250

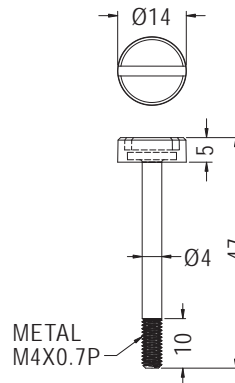

Part No.	Package
GPE4-42	250

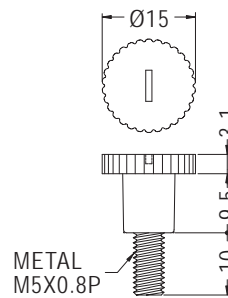

Part No.	Package
GPE5-20	500



- Head Material: PC (UL)
- Head Flame Class: 94V-2/94V-0
- Color: Black
- Unit: mm

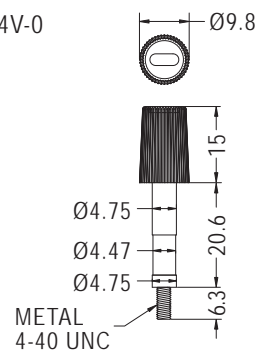

Part No.	Package
GPE44-1	500



- Head Material: PP (UL)
- Head Flame Class: 94HB
- Color: Black
- Unit: mm

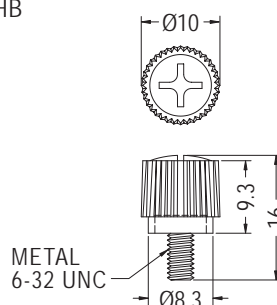

Part No.	Package
GPE632-6	500

手轉螺絲 THUMB SCREW

用途：螺絲式，固定於機殼。



- Head Material: ABS (UL)
- Head Flame Class: 94HB
- Color: Natural/Black
- Unit: mm

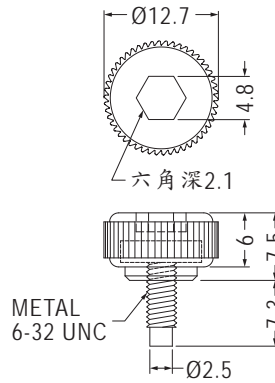

Part No.	Package
GPE632-5	500

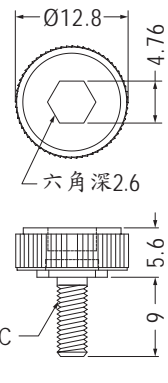

Part No.	Package
GPE632-9	500



- Head Material: PC+ABS (UL)
- Head Flame Class: 94V-2/94V-0
- Color: Black
- Unit: mm

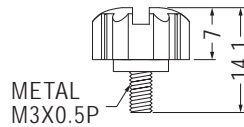
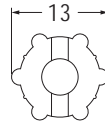

Part No.	Package
GPR3-5.5	1000

- Head Material: ABS (UL)
- Head Flame Class: 94HB
- Color: Black

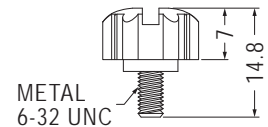
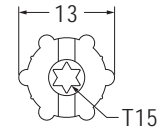

Part No.	Package
GPR632-6	500



旋鈕螺絲 SCREW

用途：用於固定需絕緣之零件，重量輕，耐腐蝕，可用手旋轉，一般用於電腦外殼之固定。



- Material: Nylon 66 (UL)
- Flame Class: 94V-2/94V-0
- Color: Natural/Black
- Unit: mm

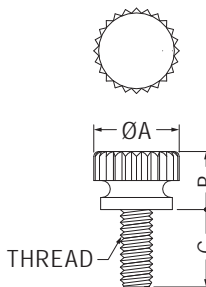

Part No.	A	B	C	Thread	Package
SUS632	9.0	6.9	9.8	6-32 UNC	1000
SUS832	10.6	7.2	9.6	8-32 UNC	

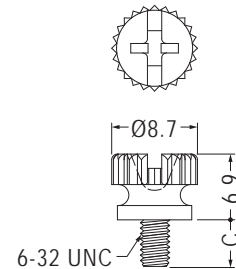

Part No.	C	Package
RSUS632	5.0	1000
RSUS632-6	6.0	

PC板拉柄 CARD PULLER

用途：與PC板導槽配合，可快速將PC板拉出與壓入。

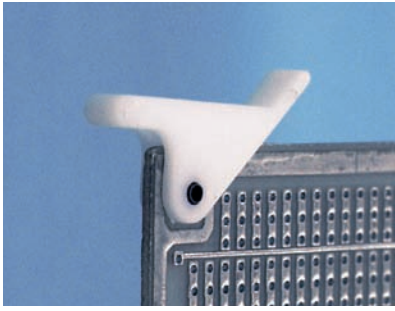

- Material: POM (UL)
- Flame Class: 94HB
- Pin Material: Steel
- Color: Natural
- Unit: mm

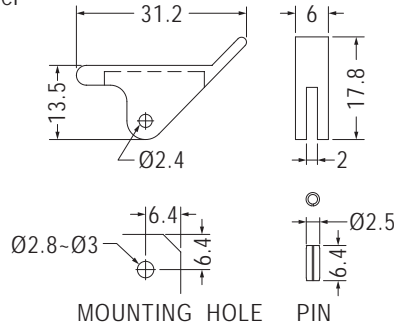

Part No.	Package
CP-15	1000

- Material: Nylon 66 (UL) /POM (UL)
- Flame Class: 94HB/94V-2/94V-0
- Pin Material: Steel
- Color: Natural/Black

- Material: Nylon 66 (UL)
- Flame Class: 94V-2/94V-0
- Pin Material: Steel
- Color: Natural/Black

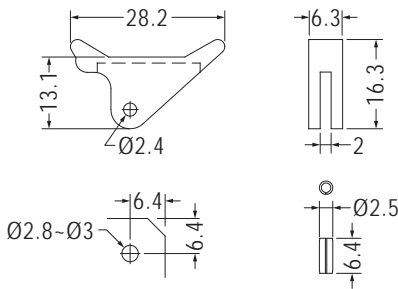

MOUNTING HOLE PIN

Part No.	Package
CP-25	1000

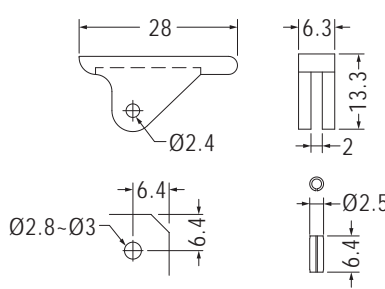

MOUNTING HOLE PIN

Part No.	Package
CP-20	1000

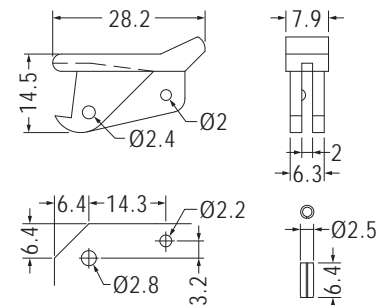

MOUNTING HOLE PIN

Part No.	Package
CP-30	1000

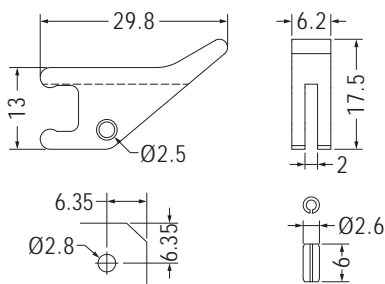

MOUNTING HOLE PIN

Part No.	Package
CP-90	1000

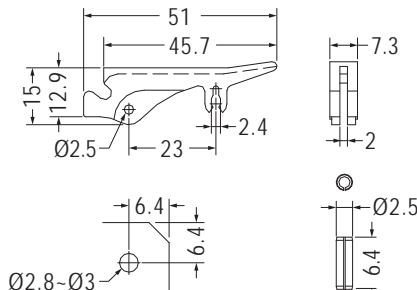

MOUNTING HOLE PIN

Part No.	Package
CP-37	500

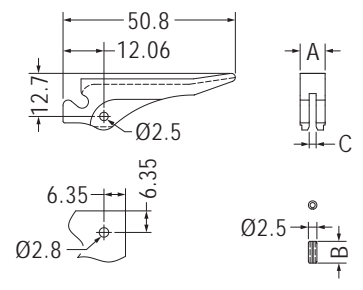

MOUNTING HOLE PIN

Part No.	A	B	C	Package
CP-38	7.3	6.4	2.0	500
CP-38L	8.8	8.0	3.5	

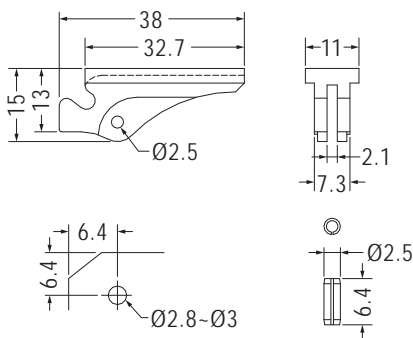

MOUNTING HOLE PIN

Part No.	Package
CP-47	500

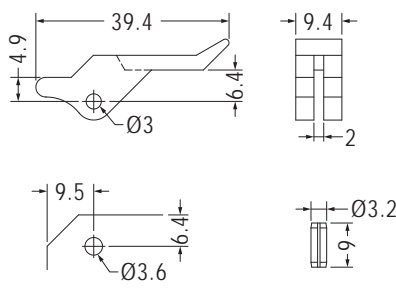

MOUNTING HOLE PIN

Part No.	Package
CP-50	500

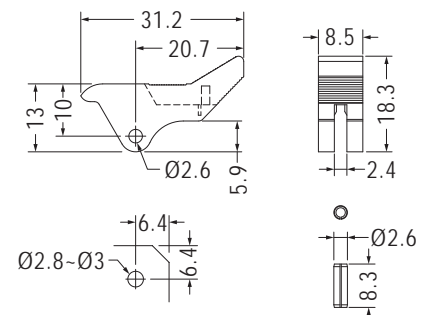

MOUNTING HOLE PIN

Part No.	Package
CP-70	1000

PC板拉柄 CARD PULLER

用途：與PC板導槽配合，可快速將PC板拉出與壓入。



- Material: POM (UL)
- Flame Class: 94HB
- Pin Material: Steel
- Color: Black
- Unit: mm

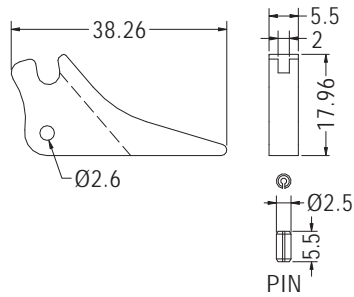

Part No.	Package
CP-72	500



- Material: Nylon 66 (UL)
- Flame Class: 94V-2/94V-0
- Pin Material: Steel
- Color: Natural/Black
- Unit: mm

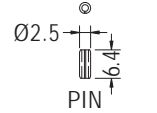
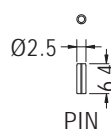
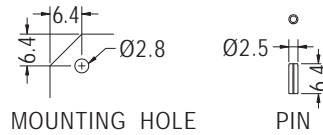
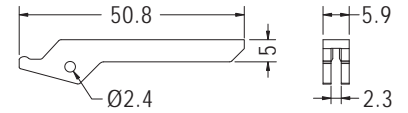
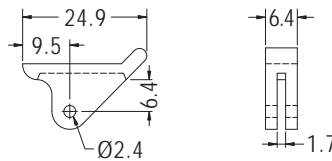

Part No.	Package
CP-82	1000

Part No.	Package
CP-84	1000

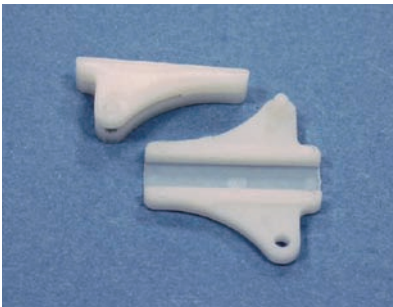

- Material: Nylon 66 (UL)
- Flame Class: 94V-2/94V-0
- Color: Natural/Black
- Unit: mm

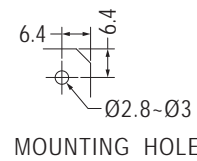
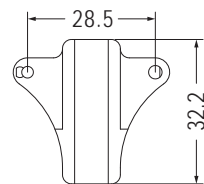
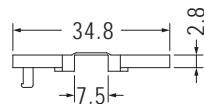

Part No.	Package
CP-35	500

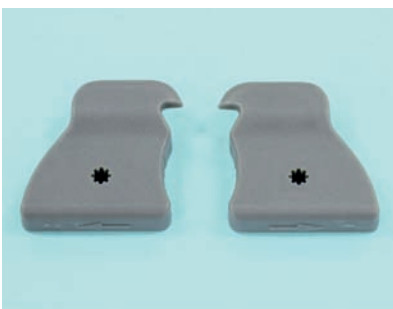

- Material: PC+ABS (UL)
- Flame Class: 94V-0
- Color: Gray/Orange
- Unit: mm

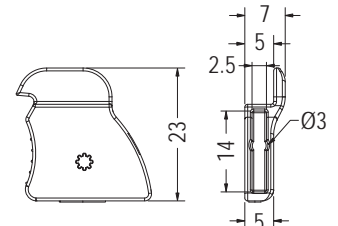
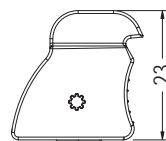
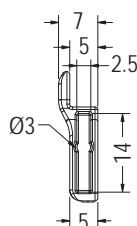

Part No.	Package
CP-76	1000

Part No.	Package
CP-77	1000

PC板導槽 CARD GUIDE

用途：用螺絲鎖於機板，固定PC板於機殼上，安裝方便。

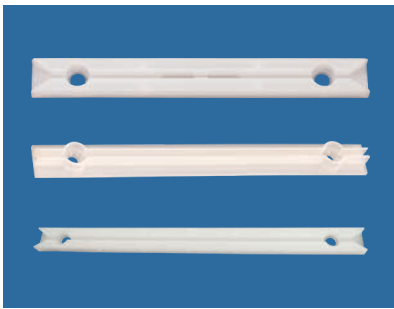

- Material: Nylon 66 (UL)
- Flame Class: 94V-2/94V-0
- Color: Natural/Black
- Unit: mm

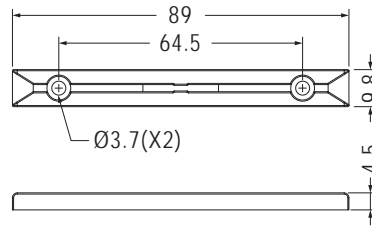

Part No.	Package
CGBC-89	250

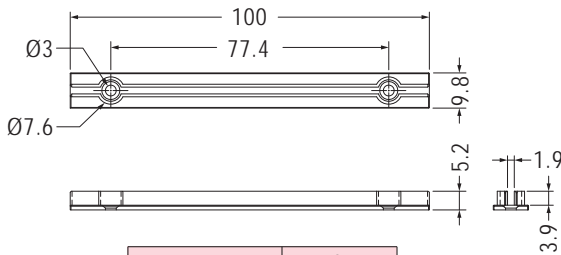

Part No.	Package
CGBB-100	250

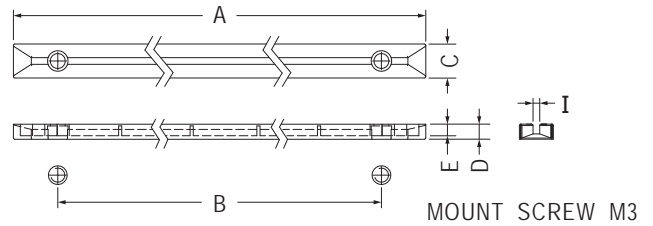

Part No.	A	B	C	D	E	I	Package
CGB-100L	100.0	77.0	10.0	7.2	5.4	2.2	250
CGB-120	119.0	94.5	9.8	4.5	3.0	1.9	
CGB-140	139.8	114.5	9.7	4.3	2.8	1.9	
CGB-160	158.7	135.0	9.7	4.3	2.8	1.9	

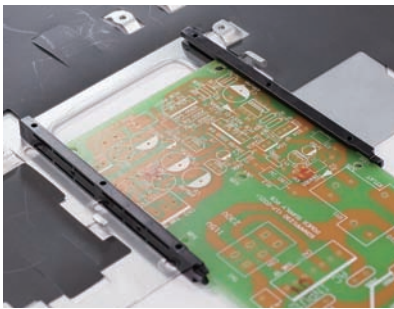

- Material: PC+ABS (UL)
- Flame Class: 94V-0
- Color: Black
- Unit: mm

用途：固定OCP3.0板於機殼或PC板上，安裝方便。

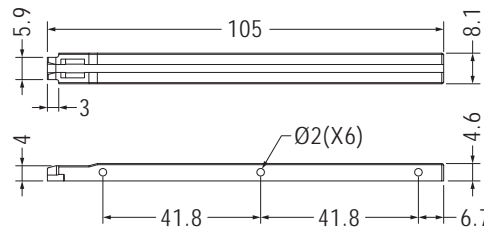

Part No.	Package
CGQ-105	250



- Material: Nylon 66 (UL)
- Flame Class: 94V-2/94V-0
- Color: Natural/Black
- Unit: mm

用途：固定PC板於機殼上，安裝方便，免螺絲。

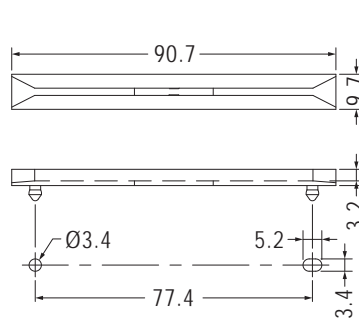

MOUNTING HOLE THICKNESS 1.2

Part No.	Package
CG-9A	250

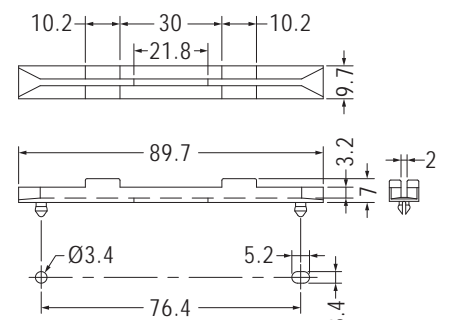

MOUNTING HOLE THICKNESS 1.2

Part No.	Package
CG-9AL	250

PC板導槽 CARD GUIDE

用途：固定PC板於機殼上，安裝方便，免螺絲。



- Material: Nylon 66 (UL)
- Flame Class: 94V-2/94V-0
- Color: Natural/Black
- Unit: mm

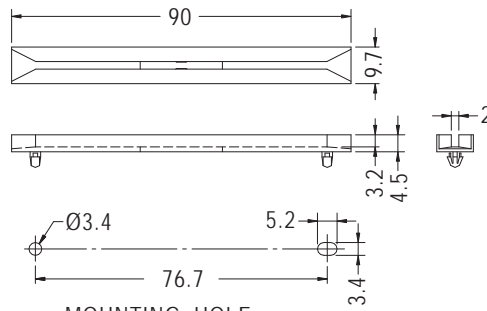

MOUNTING HOLE
CHASSIS THICKNESS 1.2

Part No.	Package
CG-9B	250

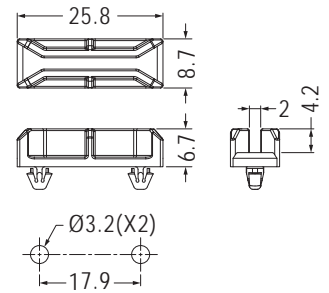

MOUNTING HOLE
THICKNESS 0.8

Part No.	Package
CG-25	500

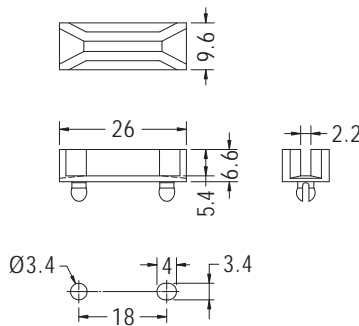
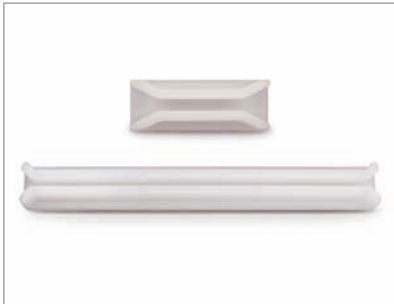
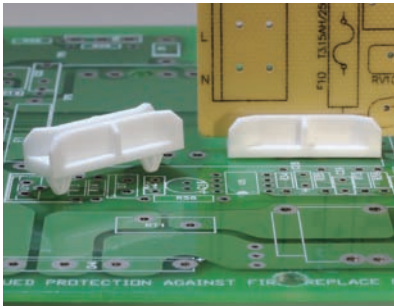

MOUNTING HOLE
CHASSIS THICKNESS 1.2

Part No.	Package
CG-26	500

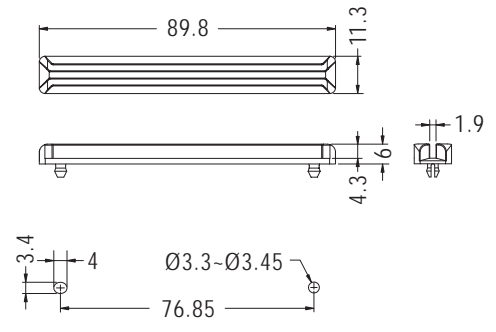

MOUNTING HOLE
CHASSIS THICKNESS 1.2-2.3

Part No.	Package
CG-9D	500

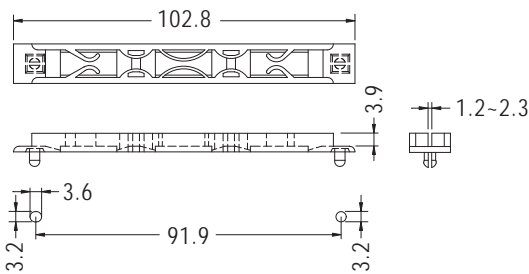

MOUNTING HOLE
CHASSIS THICKNESS 1.6-2.2

Part No.	Package
CG-10A	250



- Material: PC (UL)
- Flame Class: 94V-2/94V-0
- Color: Black
- Unit: mm

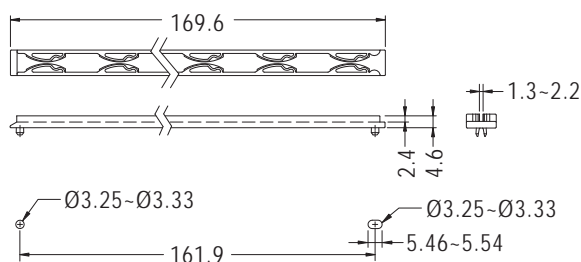

MOUNTING HOLE
CHASSIS THICKNESS 1.5-1.8

Part No.	Package
CGE-169	500

PC板導槽 CARD GUIDE

用途：固定PC板於機殼上，安裝方便，免螺絲。

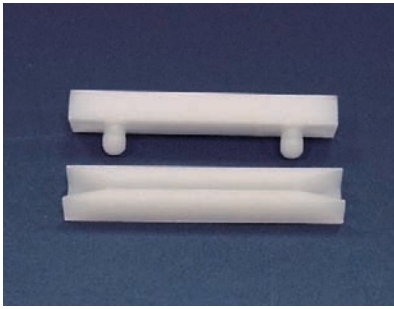

- Material: Nylon 66 (UL)
- Flame Class: 94V-2/94V-0
- Color: Natural/Black
- Unit: mm

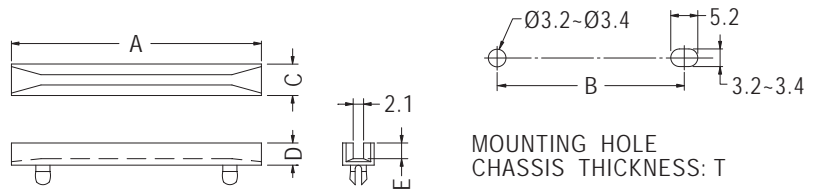

Part No.	A	B	C	D	E	T	Package
CG-38	38.0	25.4	6.4	4.5	3.2	0.8~1.2	500
CG-38L	38.0	25.4	9.6	4.6	3.0	1.0~1.6	
CG-50	50.8	38.0	6.4	4.5	3.2	0.8~1.2	
CG-50S	50.8	38.0	6.4	2.5	1.2	0.8~1.2	
CG-90S	88.9	76.2	6.4	2.8	1.5	0.8~1.2	

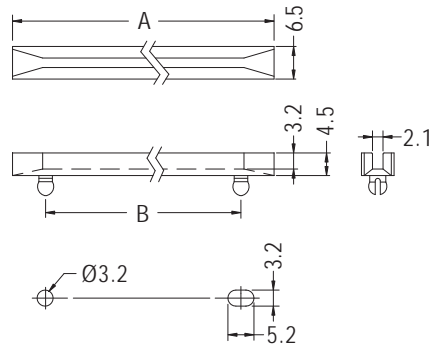
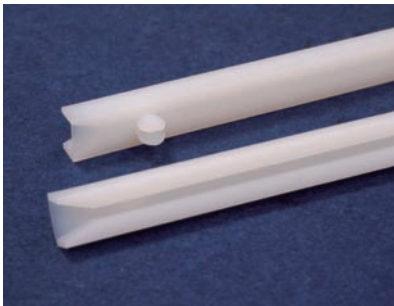

Part No.	A	B	Package
CG-250	63.5	50.8	500
CG-300	76.2	63.5	
CG-350	88.9	76.2	250
CG-400	101.6	88.9	
CG-450	114.3	101.6	200
CG-500	127.0	114.3	
CG-550	139.7	127.0	
CG-600	152.4	139.7	

MOUNTING HOLE CHASSIS THICKNESS 0.8-1.2

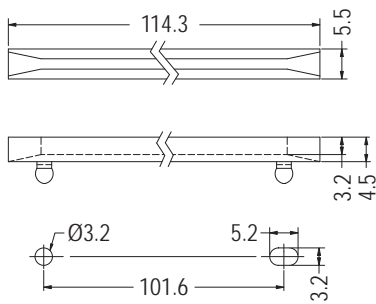

MOUNTING HOLE CHASSIS THICKNESS 0.8-1.2

Part No.	Package
CG-450S	500

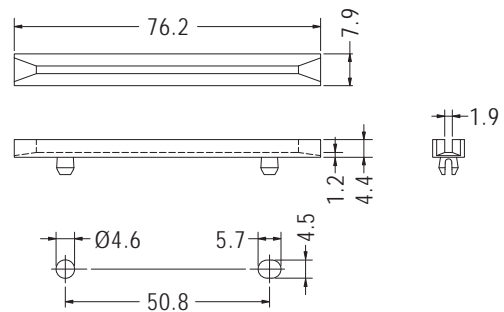

MOUNTING HOLE CHASSIS THICKNESS 1.2-2.3

Part No.	Package
CG-300L	500

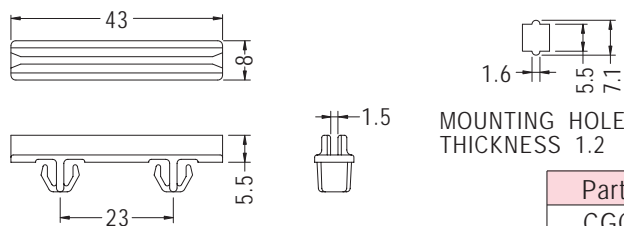
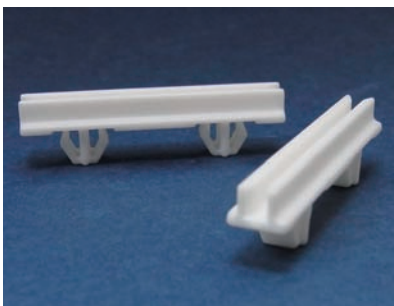

MOUNTING HOLE THICKNESS 1.2

Part No.	Package
CGC-43	500

PC板導槽 CARD GUIDE

用途：固定PC板於機殼上，安裝方便，免螺絲。

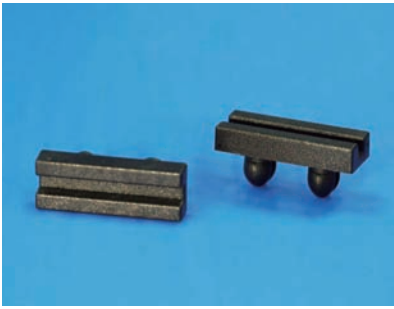

- Material: PC (UL)
- Flame Class: 94V-2
- Color: Black
- Unit: mm

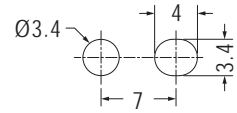
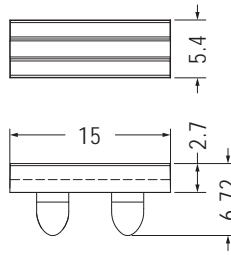

MOUNTING HOLE THICKNESS 1.0

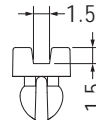

Part No.	Package
CG-15	1000

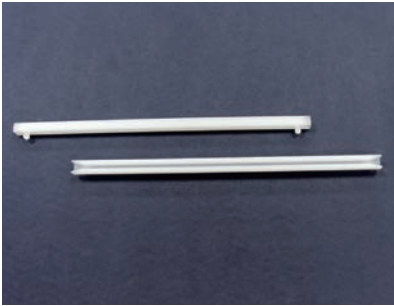

- Material: Nylon 66 (UL)
- Flame Class: 94V-2/94V-0
- Color: Natural/Black
- Unit: mm

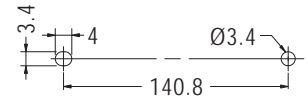
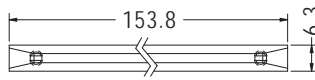

MOUNTING HOLE CHASSIS THICKNESS 1.2

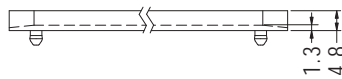

Part No.	Package
CG-153	100

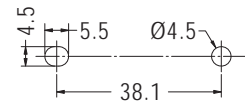
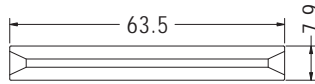

MOUNTING HOLE CHASSIS THICKNESS 0.8

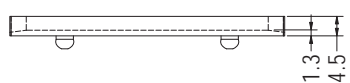

Part No.	Package
CG-63	500

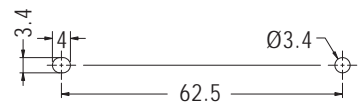
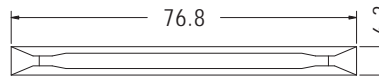

MOUNTING HOLE CHASSIS THICKNESS 1.0

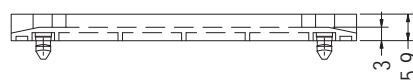

Part No.	Package
CG-77	500

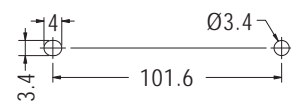
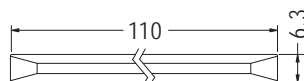

MOUNTING HOLE THICKNESS 0.8-1.2

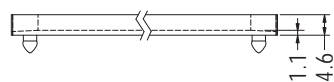

Part No.	Package
CG-110	100

PC板導槽 CARD GUIDE

用途：固定PC板於機殼上，安裝方便，免螺絲。



- Material: Nylon 66 (UL)
- Flame Class: 94V-2/94V-0
- Color: Natural/Black
- Unit: mm

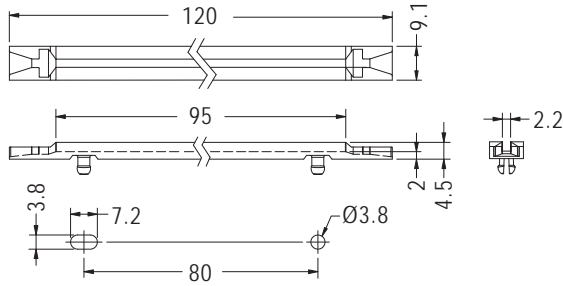

MOUNTING HOLE	Part No.	Package
CHASSIS THICKNESS 1.6	CG-120	100

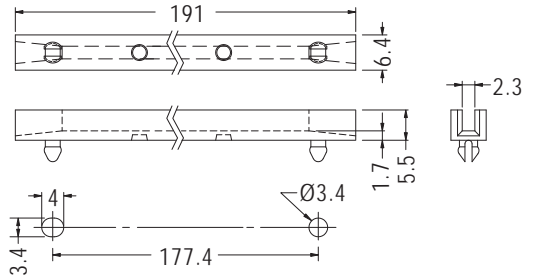

MOUNTING HOLE	Part No.	Package
CHASSIS THICKNESS 1.2	CG-191	100

- Material: PC
- Color: Black

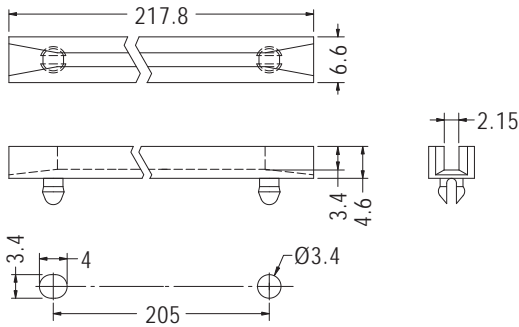

MOUNTING HOLE	Part No.	Package
CHASSIS THICKNESS 1.2	CG-218	100

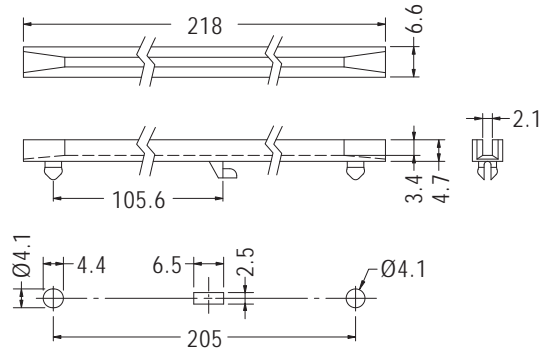

MOUNTING HOLE	Part No.	Package
CHASSIS THICKNESS 1.2	CGF-218	100

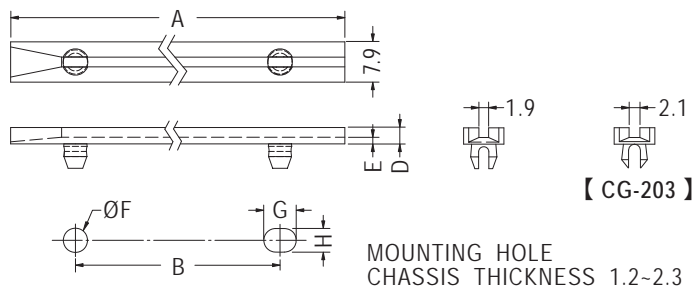
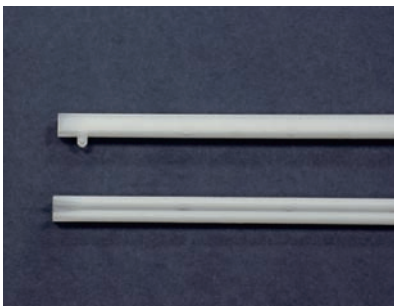

Part No.	A	B	D	E	F	G	H	Package
CG-203	203.2	177.8	3.2	1.9	4.6	5.4	4.6	100
CG-600A	152.4	127.0	3.2	1.3	4.75	6.4	4.62	200
CG-650	164.1	139.7	4.4	1.2	4.57	5.71	4.47	
CG-700	177.8	152.4	3.2	1.3	4.75	6.35	4.62	100
CG-700A	177.8	152.4	3.2	1.3	4.5	5.6	4.4	
CG-750	190.5	165.1	3.2	1.3	4.57	5.71	4.47	

PC板導槽 CARD GUIDE

用途：固定PC板於機殼上，安裝方便，免螺絲。

- Material: Nylon 66 (UL)
- Flame Class: 94V-2/94V-0
- Color: Natural/Black
- Unit: mm

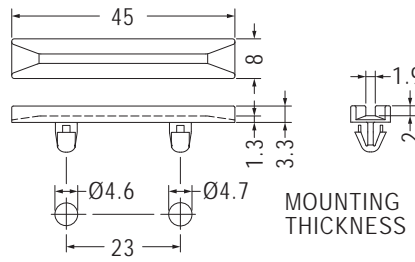
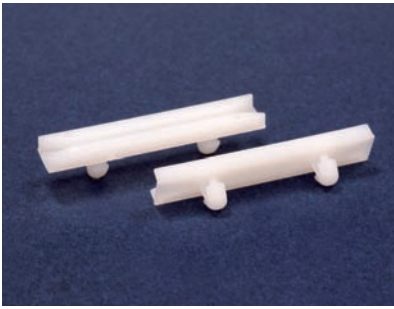

Part No.	Package
CG-45	1000

MOUNTING HOLE THICKNESS 1.6-1.8

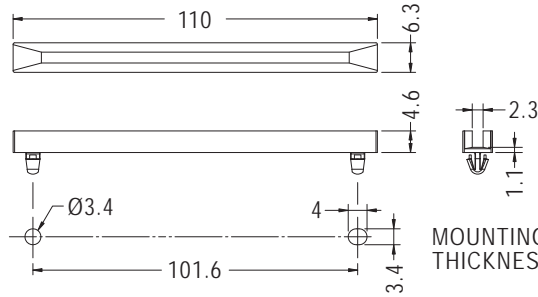

Part No.	Package
CGLJ-110	500

MOUNTING HOLE THICKNESS 1.2

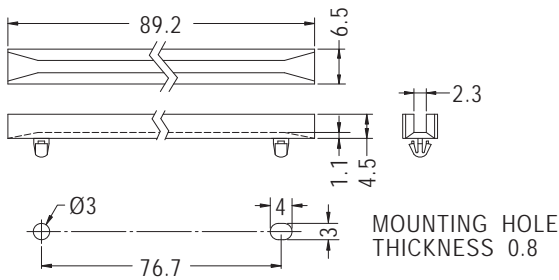

Part No.	Package
CGDLA-350	250

MOUNTING HOLE THICKNESS 0.8

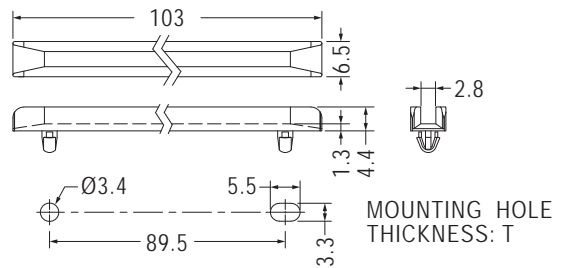

Part No.	T	Package
CGDLA-102	1.0	500
CGDLA-102L	1.5	

MOUNTING HOLE THICKNESS: T

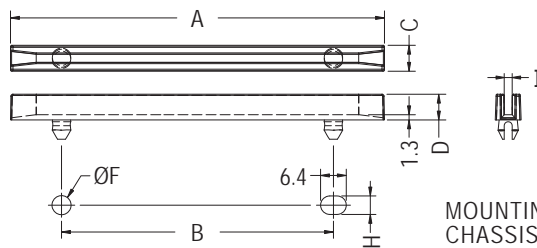

MOUNTING HOLE CHASSIS THICKNESS 1.2-2.3

Part No.	A	B	C	D	F	H	I	Package
BCG-250	63.5	38.1	6.35	6.35	4.8	4.8	2.2	500
BCG-450	114.3	88.9	6.4	6.4	4.75	4.6	2.0	

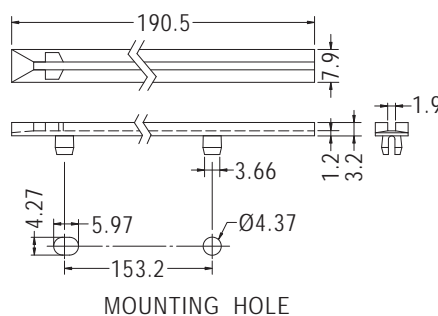
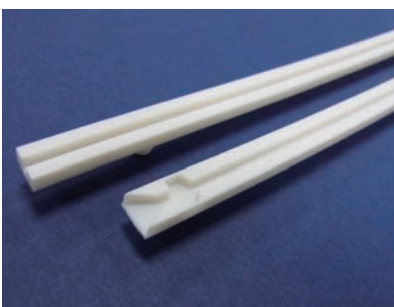

MOUNTING HOLE

Part No.	Package
FR-190	500

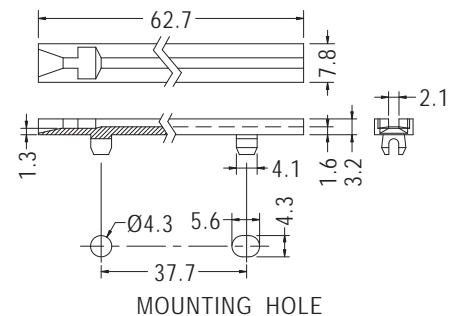

MOUNTING HOLE

Part No.	Package
FR-250	500

PC板導槽 CARD GUIDE

用途：固定PC板於機殼上，安裝方便，免螺絲。

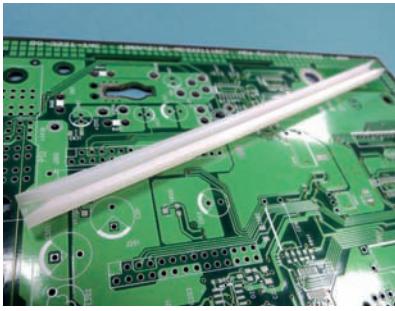

- Material: Nylon 66 (UL)
- Flame Class: 94V-2/94V-0
- Color: Natural/Black
- Unit: mm

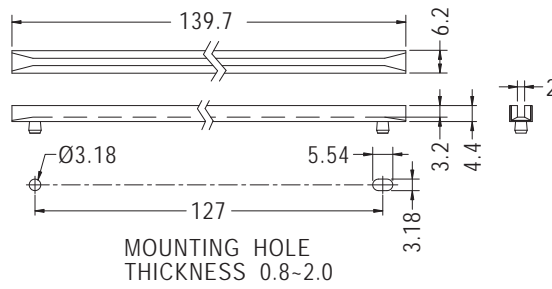

Part No.	Package
CG-140	250

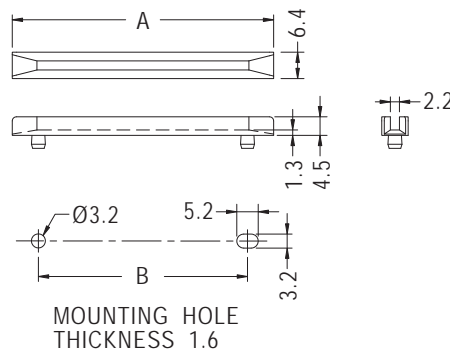
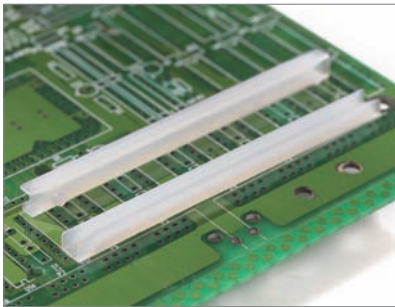

Part No.	A	B	Package
CGA-63	63.5	50.8	500
CGA-89	88.9	76.2	

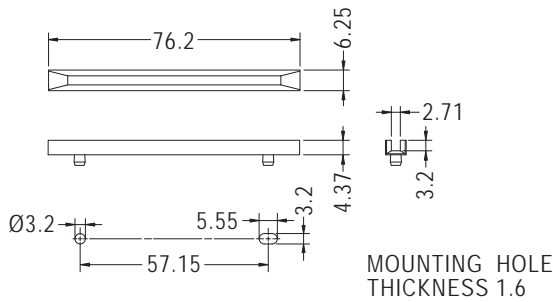

Part No.	Package
CGA-76	500

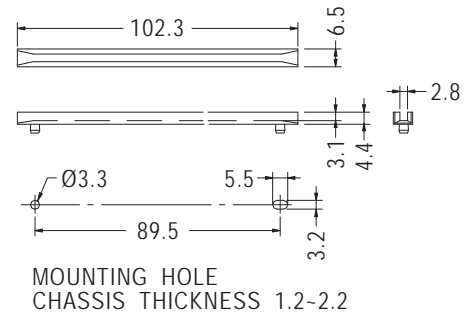

Part No.	Package
CGA-102	250

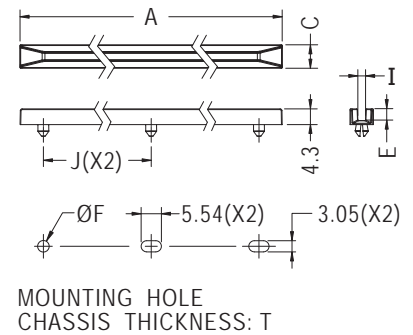
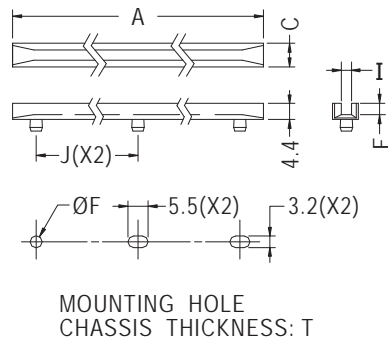

【CGA-178S】

Part No.	A	C	E	F	I	J	T	Package
CGA-178	178.5	6.5	3.1	3.3	2.8	83.0	1.2-2.2	200
CGA-178S	177.8	6.4	3.2	3.18	2.0	82.55	1.2-2.2	
CGA-203	203.2	6.2	3.2	3.2	2.0	95.2	1.2-2.0	100
CGA-217	217.0	6.5	3.1	3.3	2.8	102.0	1.2-2.2	200

PC板導槽 CARD GUIDE

用途：用螺絲鎖於機板，固定PC板於機殼上，安裝方便。



- Material: Nylon 66 (UL)
- Flame Class: 94V-2/94V-0
- Color: Natural/Black
- Unit: mm

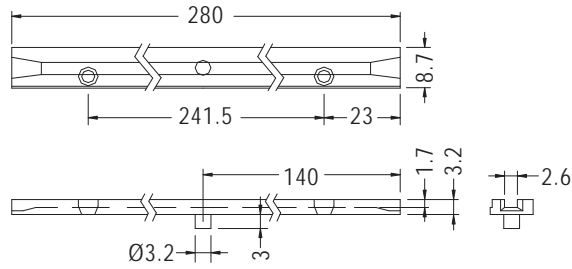

Part No.	Package
CGS-280	100

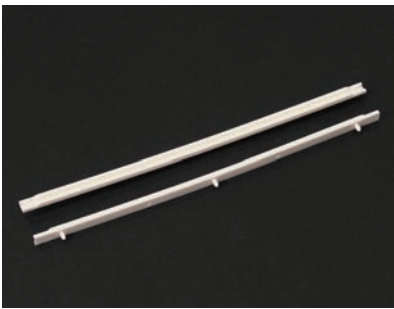

- Material: Nylon 66 (UL)
- Flame Class: 94V-2/94V-0
- Color: Natural/Black
- Unit: mm

用途：固定PC板於機殼上，安裝方便，免螺絲。

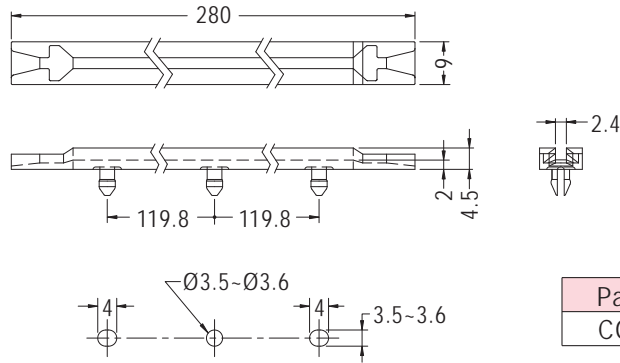

HOLE IN CHASSIS THICKNESS 2.0

Part No.	Package
CG-280	100

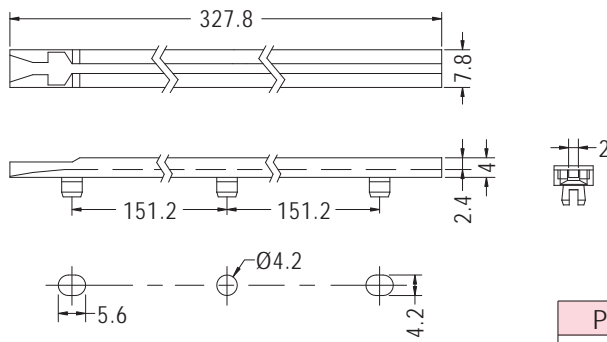

MOUNTING HOLE

Part No.	Package
FR-1300	100

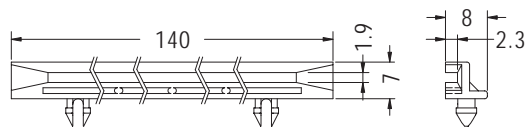
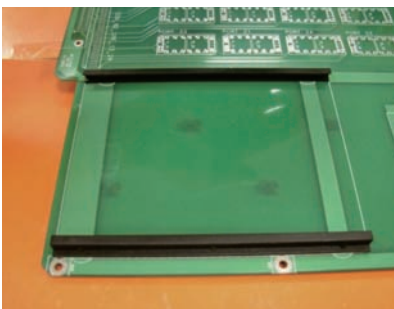

MOUNTING HOLE P.C.B THICKNESS 1.6

Part No.	Package
CGA-140	100

PC板導槽 CARD GUIDE

用途：固定PC板於機殼上，安裝方便，免螺絲。

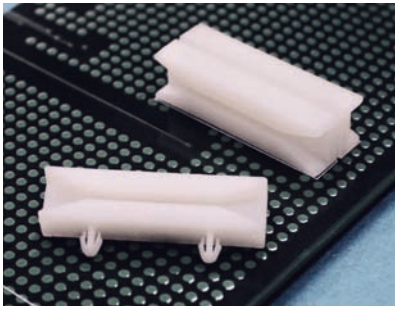

- Material: Nylon 66 (UL)
- Flame Class: 94V-2/94V-0
- Color: Natural/Black
- Unit: mm

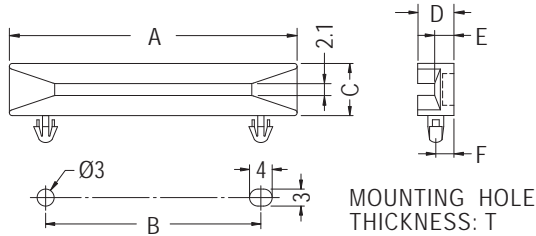

Part No.	A	B	C	D	E	F	T	Package
CGLA-4	38.4	20.0	9.2	6.4	3.4	3.2	1.6~1.7	500
CGLA-4(1)	38.4	20.0	9.2	6.4	3.4	3.2	1.0	
CGLA-4(2)	38.4	20.0	9.2	6.4	3.4	3.2	2.0	
CGLA-4S	40.0	20.0	8.0	6.0	3.0	3.0	1.6	
CGLA-6	51.0	38.2	9.2	6.4	3.4	3.2	1.6~1.7	
CGLA-8	81.0	60.0	8.0	6.0	3.0	3.0	1.6~1.8	250
CGLA-8(2)	81.0	60.0	8.0	6.0	3.0	3.0	1.8~2.1	
CGLA-8(8)	81.0	60.0	8.0	6.0	3.0	3.0	1.8	
CGLA-8(25)	81.0	60.0	8.0	6.0	3.0	3.0	2.5	
CGLA-9(1)	91.5	71.0	8.0	6.0	3.0	3.0	1.6~1.8	
CGLA-9(2)	91.5	71.0	8.0	6.0	3.0	3.0	1.8~2.1	

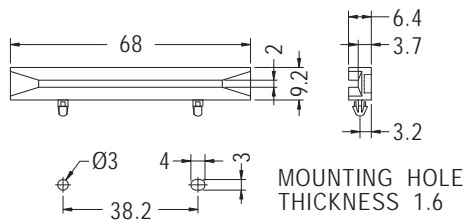

Part No.	Package
CGLA-10	200

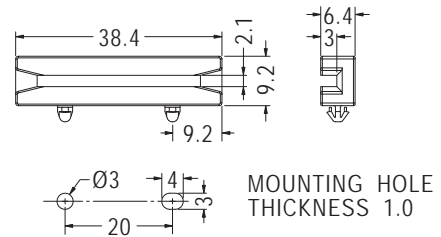

Part No.	Package
CGLA-11	500

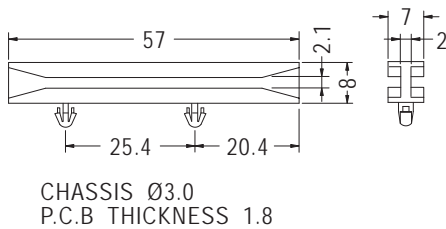

Part No.	Package
CGDLA-57	500

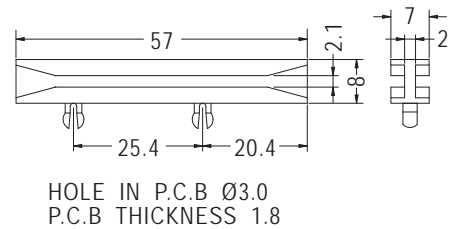

Part No.	Package
CGDLB-57	500

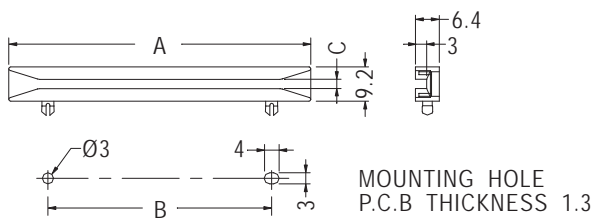

Part No.	A	B	C	Package
CGL-4	38.4	20.0	2.0	500
CGL-8	81.0	60.0	2.5	250

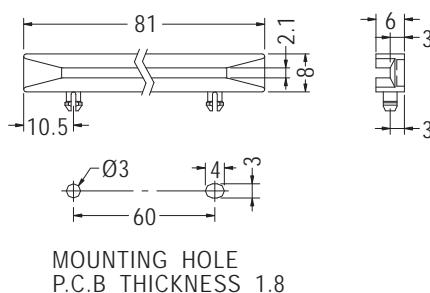
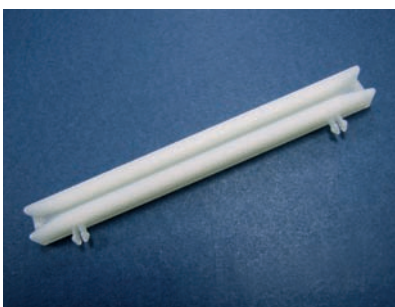

Part No.	Package
CGLC-8	500

PC板導槽 CARD GUIDE

用途：固定IC卡於PC板上，安裝方便，免螺絲。

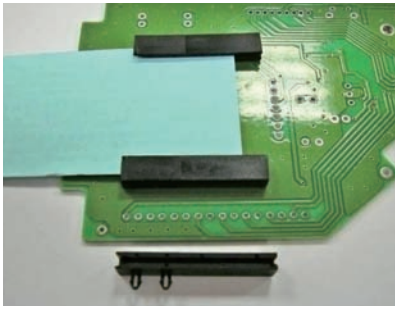

- Material: Nylon 66 (UL)
- Flame Class: 94V-2/94V-0
- Color: Black
- Unit: mm

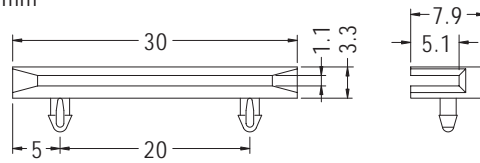

MOUNTING HOLE $\varnothing 2.0$
P.C.B THICKNESS 1.6

Part No.	Package
CGLC-30	500

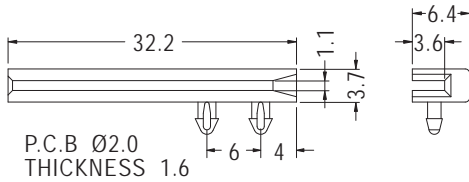

P.C.B $\varnothing 2.0$
THICKNESS 1.6

Part No.	Package
CGLC-32-1	500

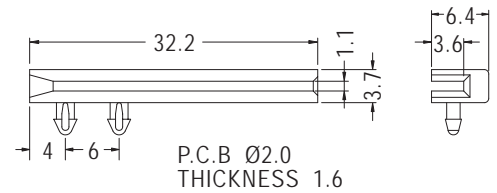

P.C.B $\varnothing 2.0$
THICKNESS 1.6

Part No.	Package
CGLC-32-2	500

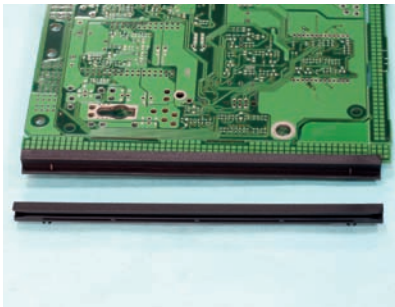

- Material: Nylon 66 (UL)
- Flame Class: 94V-2/94V-0
- Color: Natural/Black
- Unit: mm

用途：固定PC板於機殼上，安裝方便，免螺絲。

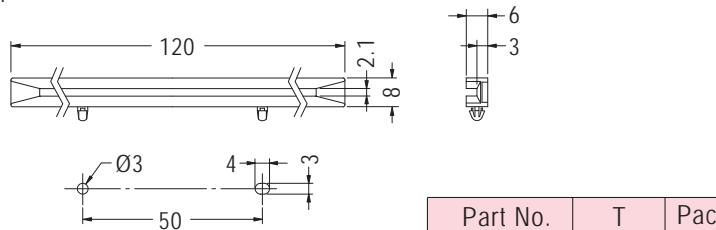

MOUNTING HOLE $\varnothing 3$
CHASSIS THICKNESS: T

Part No.	T	Package
CGLC-120	1.6-1.8	200
CGLC-120S	1.0	

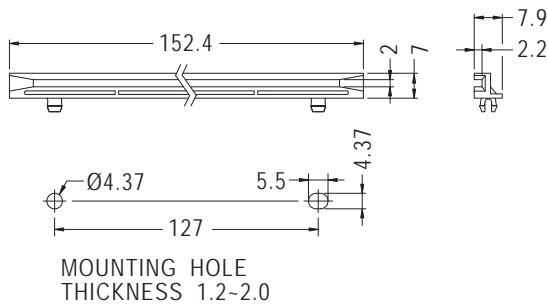

MOUNTING HOLE
THICKNESS 1.2-2.0

Part No.	Package
CGLO-153	250

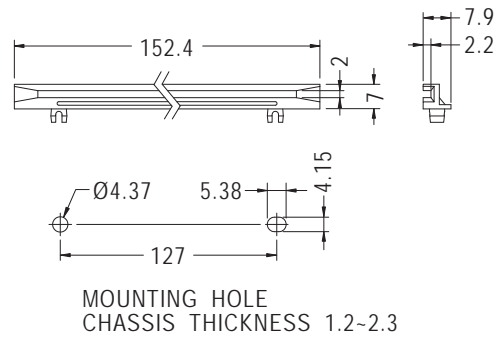

MOUNTING HOLE
CHASSIS THICKNESS 1.2-2.3

Part No.	Package
CGLC-153	250

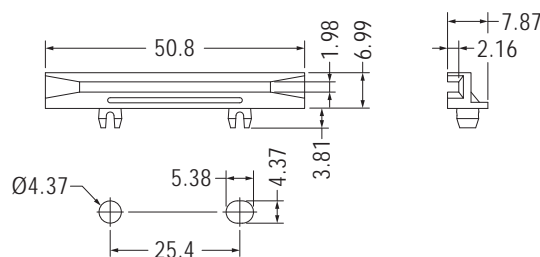
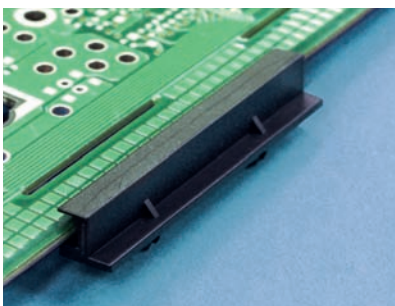

MOUNTING HOLE
THICKNESS 1.2-2.3

Part No.	Package
CGLC-50.8	1000

PC板導槽 CARD GUIDE

用途：固定PC板於機殼上，安裝方便，免螺絲。



- Material: ABS (UL)
- Flame Class: 94V-0
- Color: Black
- Unit: mm

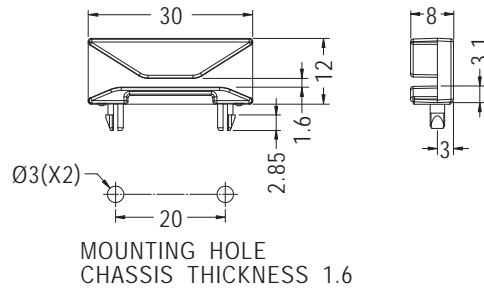

Part No.	Package
CG-30	500

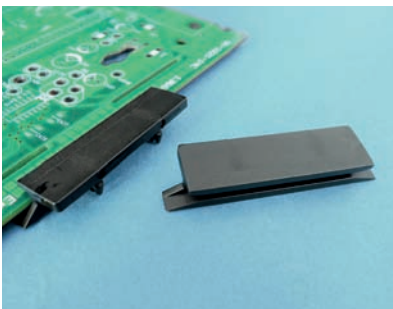

- Material: Nylon 66 (UL)
- Flame Class: 94V-2/94V-0
- Color: Natural/Black
- Unit: mm
- Patented (專利品)

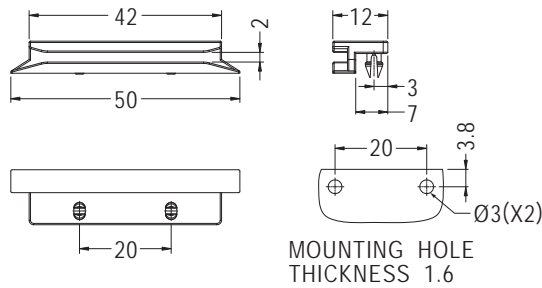

Part No.	Package
CGLD-50	500

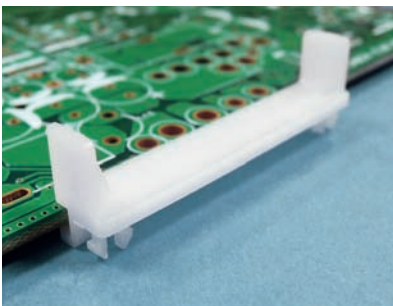

- Material: Nylon 66 (UL)
- Flame Class: 94V-2/94V-0
- Color: Natural/Black
- Unit: mm

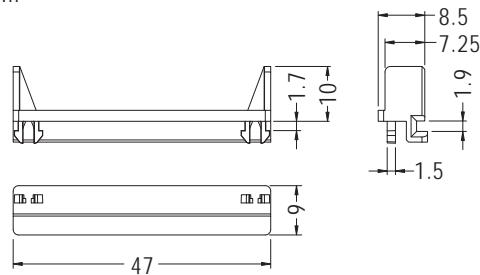

Part No.	Package
CGLG-47	1000

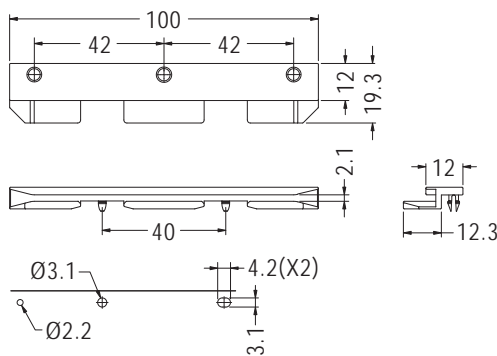
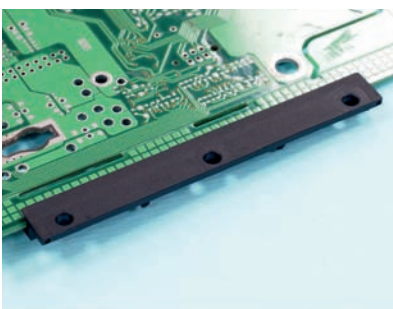

Part No.	Package
CGLI-100	1000

PC板導槽 CARD GUIDE

用途：固定OCP3.0板於機殼或PC板上，安裝方便。

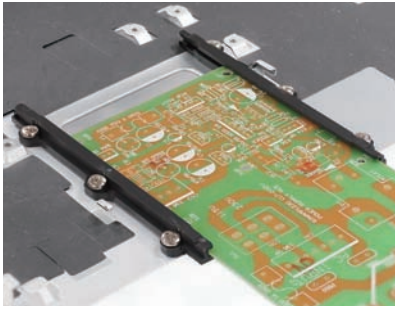

- Material: Nylon 66 (UL)
- Flame Class: 94V-0
- Color: Black
- Unit: mm

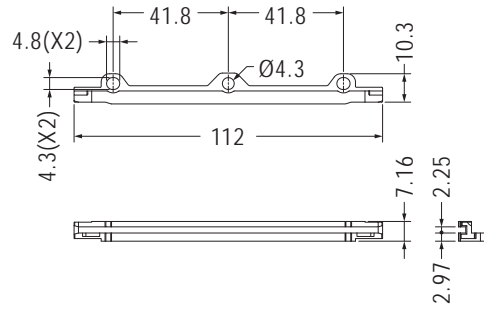

Part No.	Package
CGLN-9	250

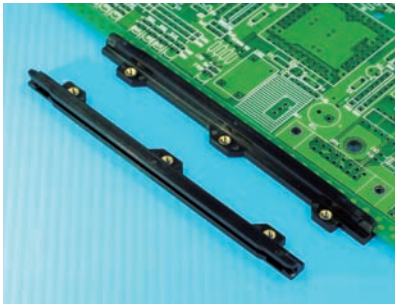

- Material: PC+ABS (UL)
- Flame Class: 94V-0
- Color: Black
- Unit: mm

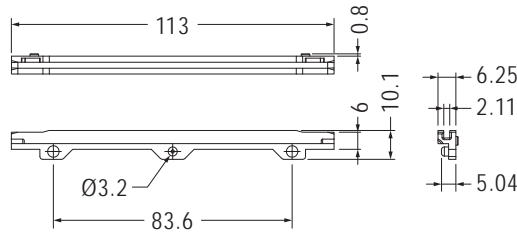

Part No.	Package
CGLM-1N	250

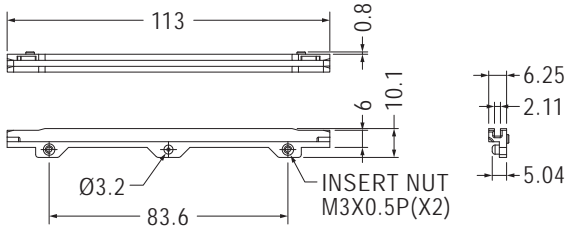

Part No.	Package
CGLM-1	250

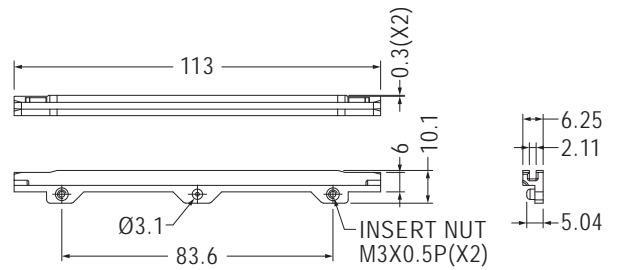

Part No.	Package
CGLM-2	250

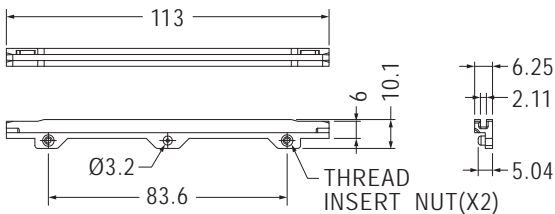

Part No.	Thread	Package
CGLM-113	M3X0.5P	250
CGLM-113-M2	M2X0.4P	

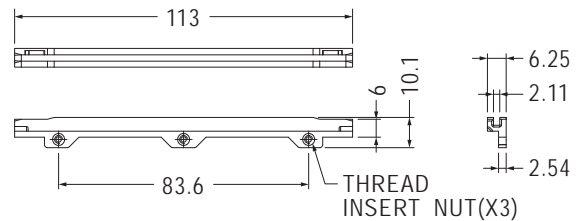

Part No.	Thread	Package
CGLN-113	M3X0.5P	250
CGLN-113-M2	M2X0.4P	

PC板導槽 CARD GUIDE

用途：固定OCP3.0板於機殼或PC板上，安裝方便。

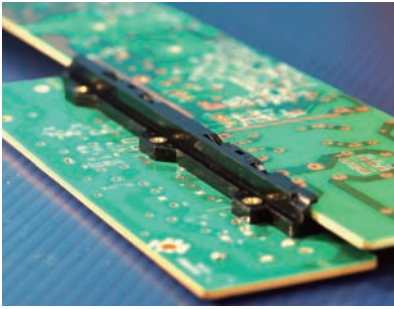

- Material: PC+ABS (UL)
- Flame Class: 94V-0
- Color: Black
- Unit: mm

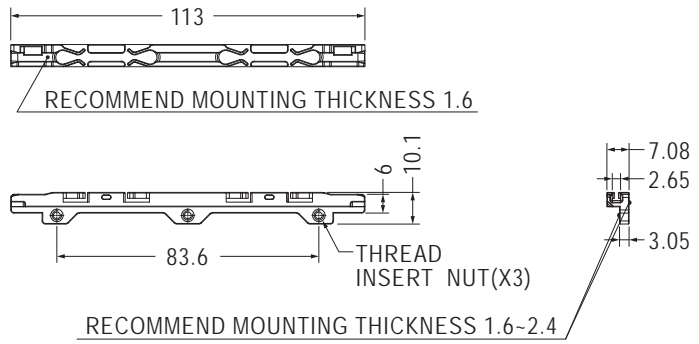

Part No.	Thread	Package
CGLN-2	M3X0.5P	250
CGLN-2-M2	M2X0.4P	

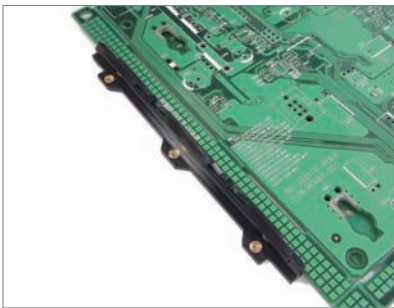

- Material: PC+ABS (UL)
- Nut Material: Brass
- Flame Class: 94V-0
- Color: Black
- Unit: mm

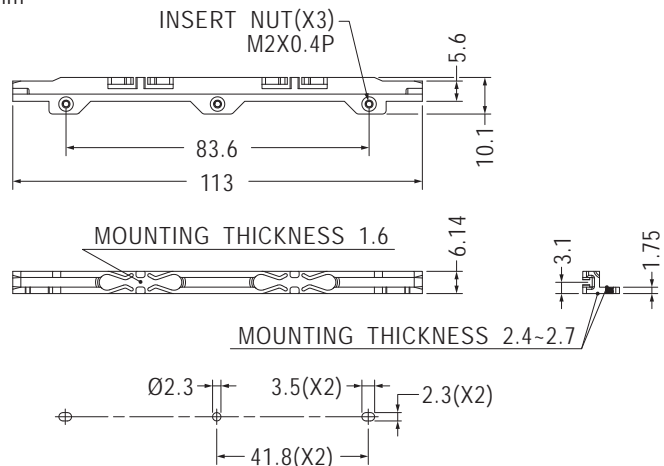

RECOMMEND MOUNTING HOLE
RECOMMEND THICKNESS 2.4-2.7

Part No.	Package
CGLN-6-M2	250

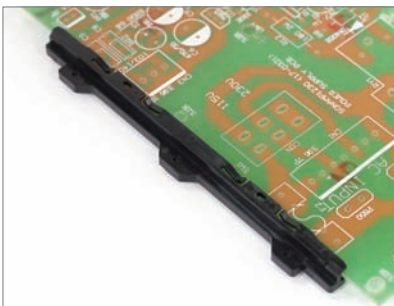

- Material: PC+ABS (UL)
- Flame Class: 94V-0
- Color: Black
- Unit: mm

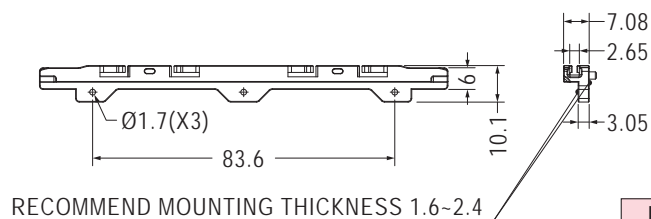
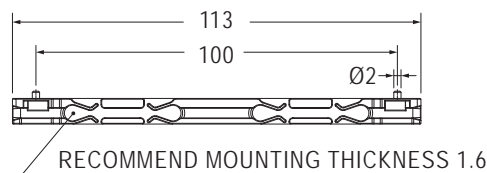

Part No.	Package
CGLN-3	250

PC板導槽 CARD GUIDE

用途：固定OCP3.0板於機殼或PC板上，安裝方便。

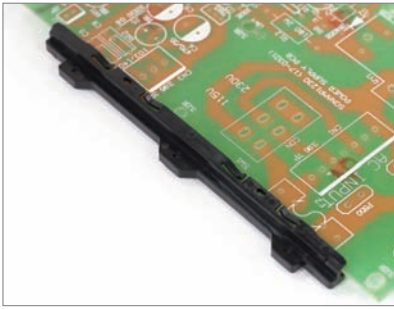

- Material: PC+ABS (UL)
- Flame Class: 94V-0
- Color: Black
- Unit: mm

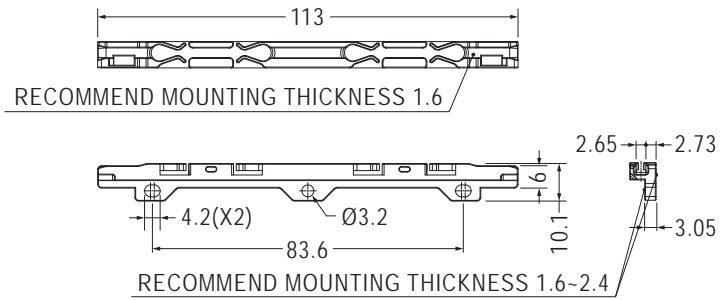

Part No.	Package
CGLN-5	250

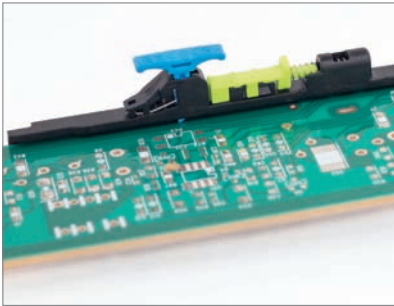

- Material: PC+ABS (UL)
- Flame Class: 94V-0
- Color: Black
- Unit: mm
- Patented (專利品)

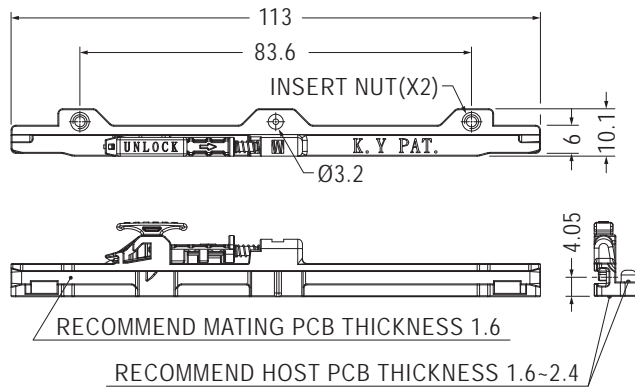

Part No.	Package
CGLP-3F-M2	100



使用說明
Installation Step

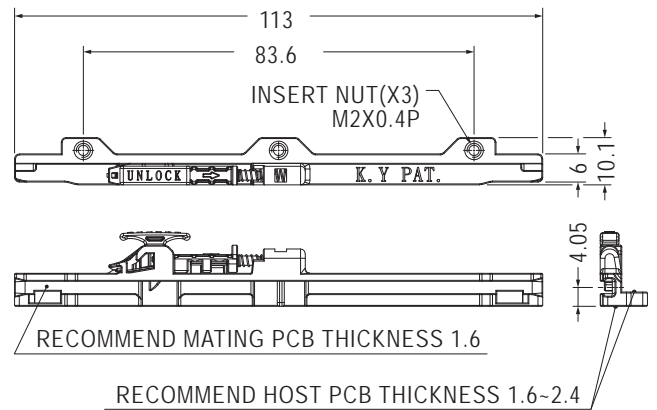
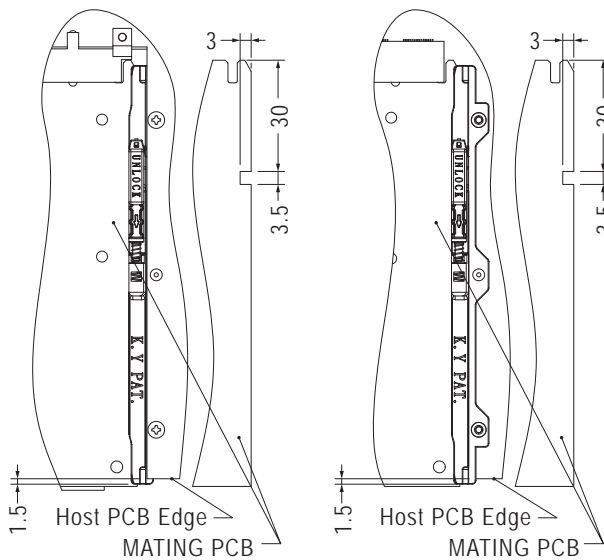

Part No.	Package
CGLP-5F-M2	100

PC板導槽 CARD GUIDE

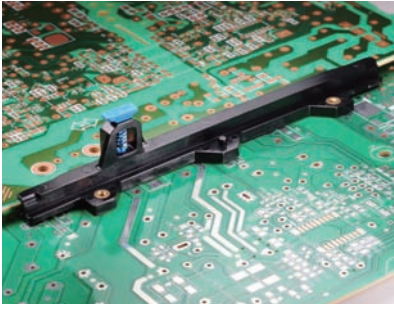

- Material: PC+ABS (UL)
- Pin Material: Nylon 66 (UL)
- Flame Class: 94V-0
- Nut Material: Brass
- Spring Material: Nickel Plated SWP
- Color: Black
- Pin Color: Blue
- Unit: mm
- Patented (專利品)

用途：固定OCP3.0板於機殼或PC板上，安裝方便。

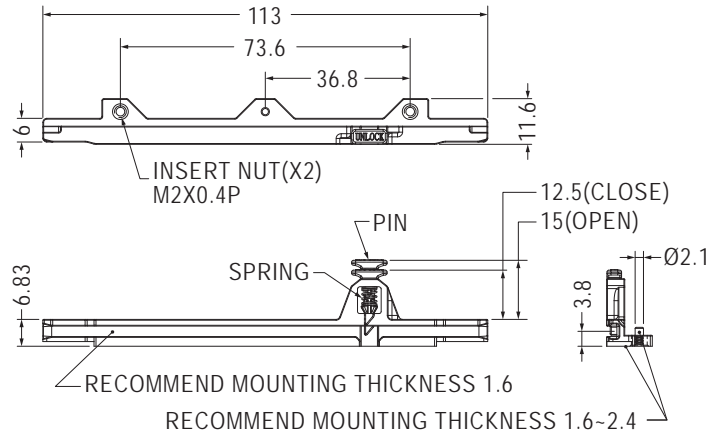

Part No.	Package
CGLP-4F-M2	100

直立式導槽 CARD GUIDE

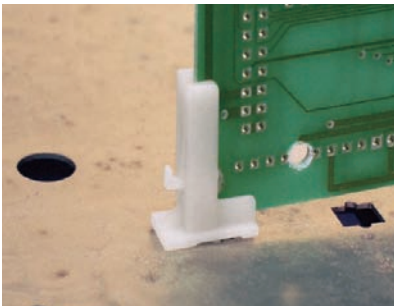

- Material: Nylon 66 (UL)
- Flame Class: 94V-2/94V-0
- Color: Natural/Black
- Unit: mm

用途：固定PC板於機殼或PC板上，安裝方便，免螺絲。

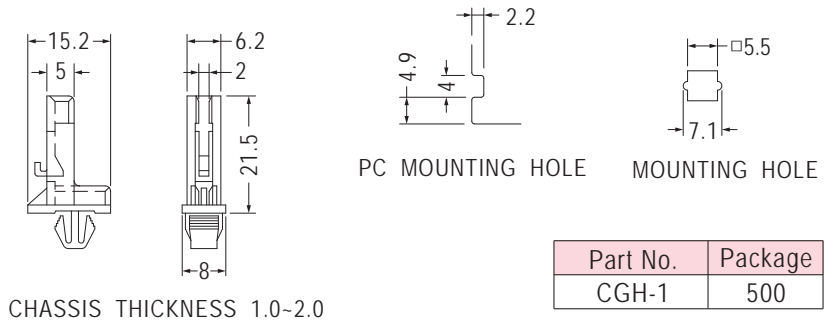

Part No.	Package
CGH-1	500

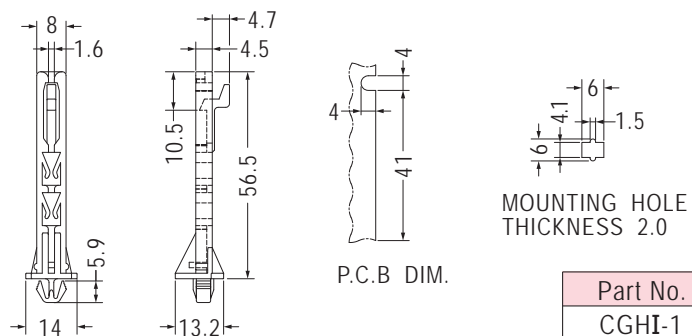
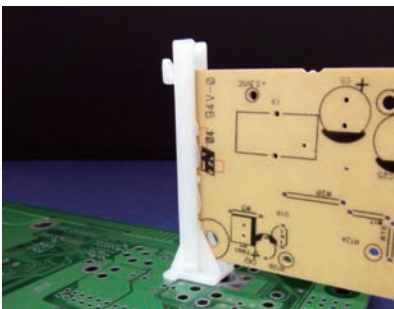

Part No.	Package
CGHI-1	500

直立式導槽 CARD GUIDE

用途：固定PC板於機殼或PC板上，安裝方便，免螺絲。

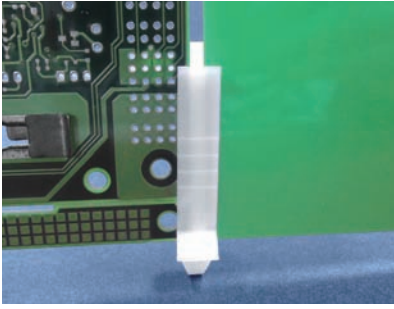

- Material: Nylon 66 (UL)
- Flame Class: 94V-2/94V-0
- Color: Natural/Black
- Unit: mm

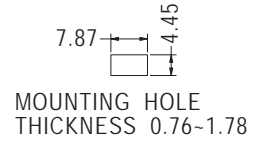
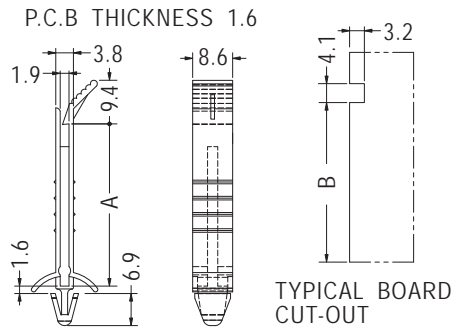

Part No.	A	B	Package
CGHE-22.4	22.4	22.0	500
CGHE-34.9	34.9	34.5	
CGHE-47.5	47.5	47.1	
CGHE-73	73.0	72.6	

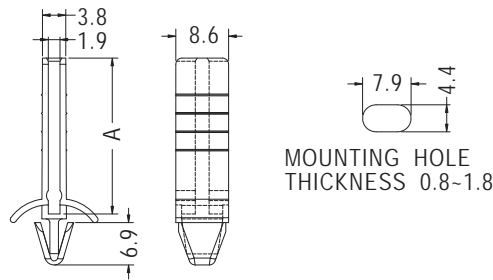
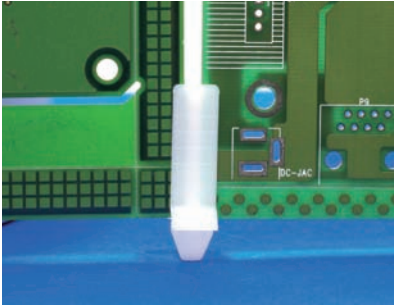

Part No.	A	Package
CGHC-25.4	25.4	500
CGHC-38.1	38.1	
CGHC-50.8	50.8	200
CGHC-76.2	76.2	

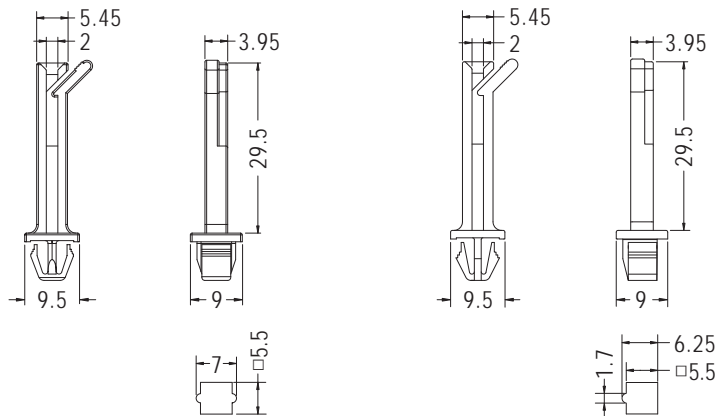

MOUNTING HOLE THICKNESS 1.2-1.8

MOUNTING HOLE THICKNESS 2.0-3.0

Part No.	Package
CGH-31	500

Part No.	Package
CGH-31L	500

直立式導槽 CARD GUIDE

用途：固定PC板於機殼或PC板上，安裝方便，免螺絲。

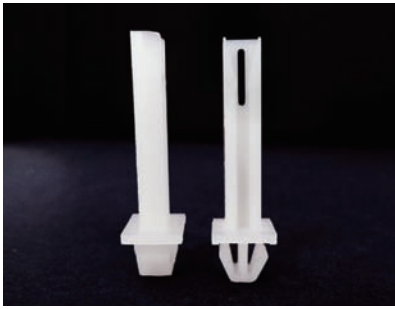

- Material: Nylon 66 (UL)
- Flame Class: 94V-2/94V-0
- Color: Natural/Black
- Unit: mm

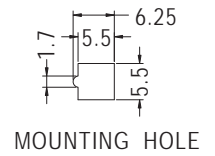
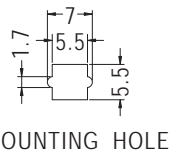
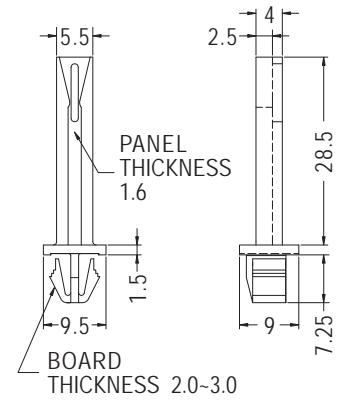
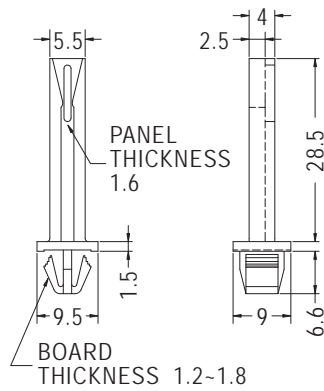

Part No.	Package
CGH-37	1000

Part No.	Package
CGH-37L	1000

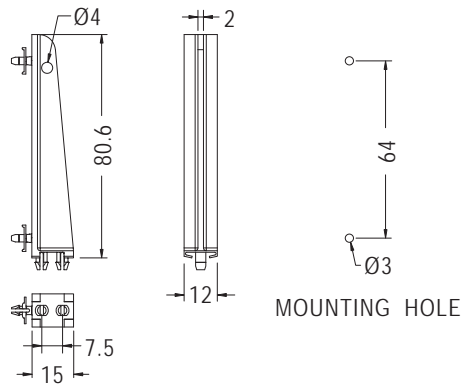
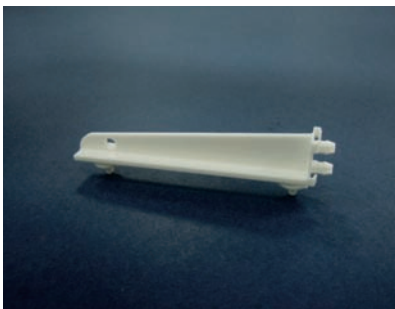

Part No.	Package
CGC-1	250



- Material: PC+ABS (UL)
- Flame Class: 94V-2
- Color: Black/Blue
- Unit: mm

用途：配合螺絲固定PC板於機殼或PC板上，安裝牢固，不脫落。

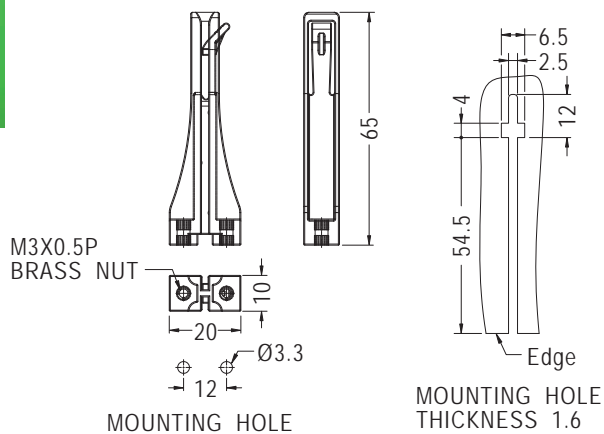

Part No.	Package
CGHA-65	500

直立式導槽 CARD GUIDE

用途：配合螺絲固定PC板於機殼或PC板上，安裝牢固，不脫落。

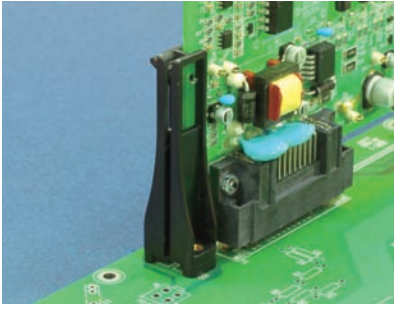

- Material: PC+ABS (UL)
- Flame Class: 94V-2/94V-0
- Color: Black/Blue
- Unit: mm

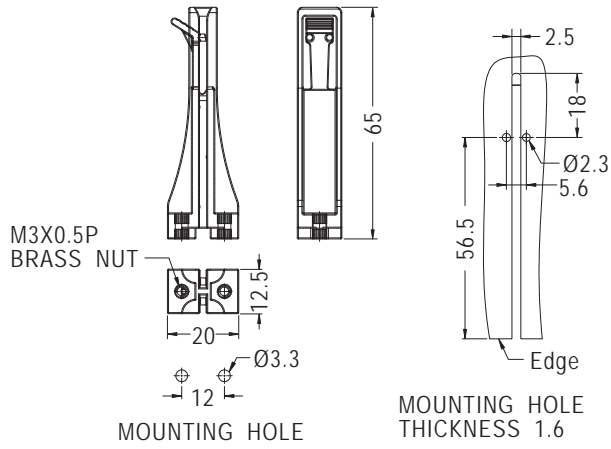

Part No.	Package
CGHB-65	500

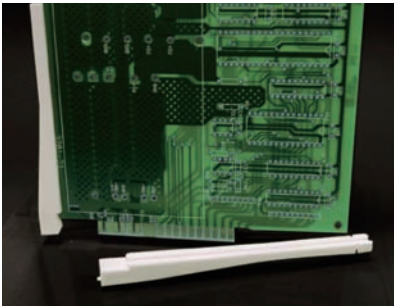

- Material: Nylon 66 (UL)
- Flame Class: 94V-2/94V-0
- Color: Natural/Black
- Unit: mm

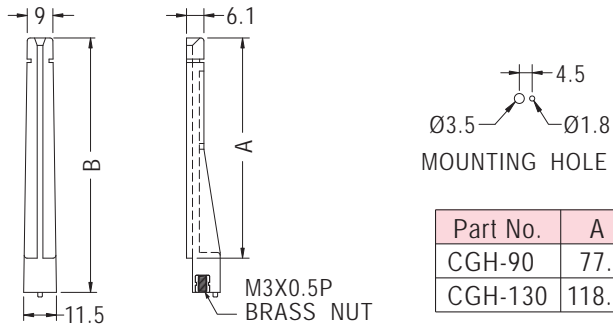

Part No.	A	B	Package
CGH-90	77.2	89.2	200
CGH-130	118.5	130.0	100

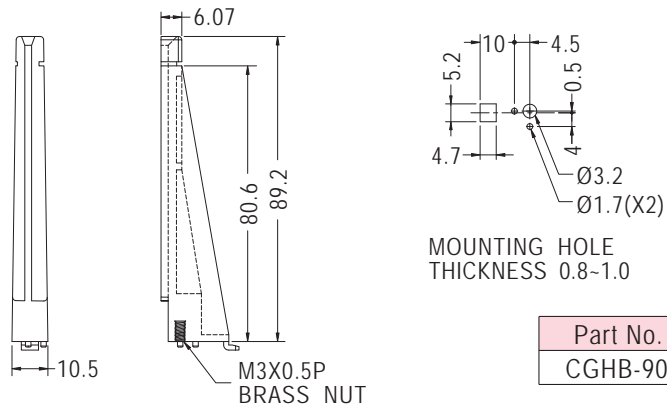
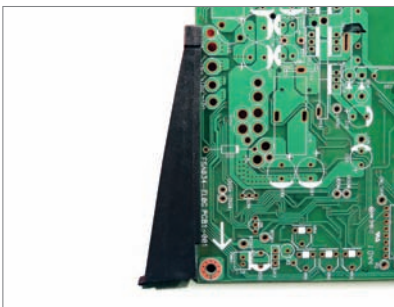

Part No.	Package
CGHB-90	1000

用途：固定PC板於機板上，成90°不晃動。

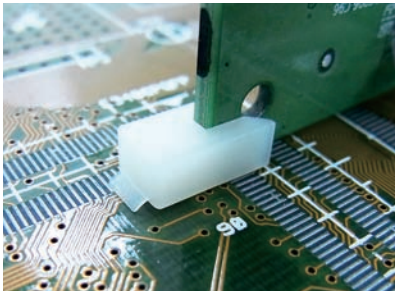

- Material: Nylon 66 (UL)
- Flame Class: 94V-2/94V-0
- Color: Natural/Black
- Unit: mm

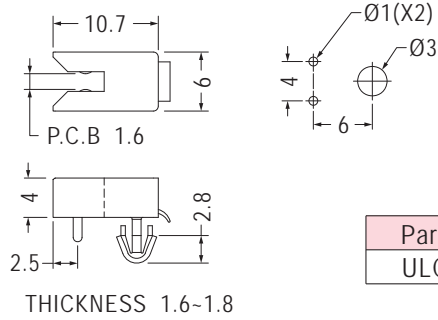

Part No.	Package
ULCG-1	1000



- Material: Nylon 66 (UL)
- Flame Class: 94V-2/94V-0
- Color: Natural/Black
- Unit: mm

用途：固定PC板於機殼上，安裝方便，免螺絲。

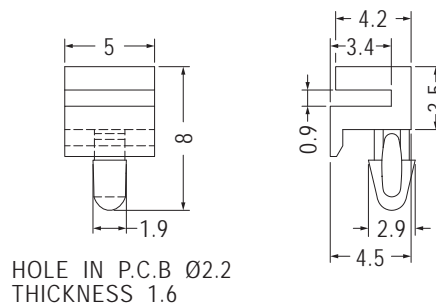

Part No.	Package
ULCG-2	1000

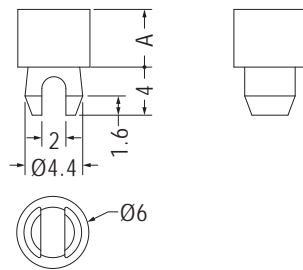
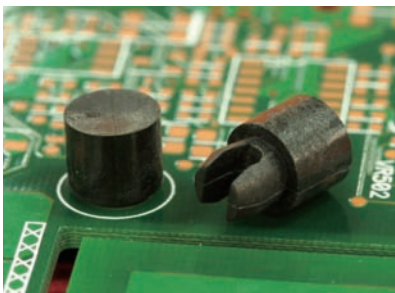

HOLE IN CHASSIS Ø4.3
BOARD THICKNESS 1.6-2.0

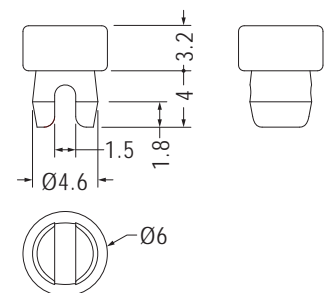

MOUNTING HOLE Ø4.5
THICKNESS 1.6

- Flame Class: 94HB
- Color: Black

Part No.	A	Package
CGB-2	2.0	2000
CGB-6	4.8	

Part No.	Package
CGB-3.2	2000

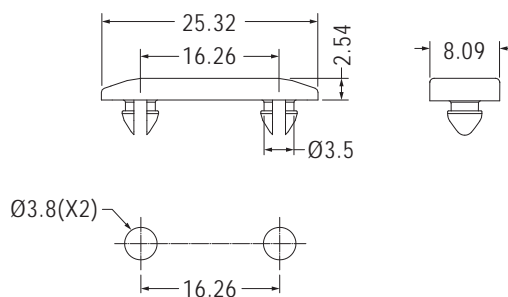

MOUNTING HOLE
THICKNESS 1.2

Part No.	Package
INTEC-1	500

9



- 腳墊
Plastic Foot
- 橡膠腳墊
Rubber Foot
- 金框腳墊
Gold Covering Foot
- 銀框腳墊
Silver Covering Foot
- 矽橡膠墊圈/華司
Rubber O-rings & Washers
- 泡棉
Foam
- 功率晶體導熱矽膠片
Transistor Thermal Conductive Pads



腳墊 PLASTIC FOOT

用途：插銷式，可快速將腳墊固定於機殼，不脫落。

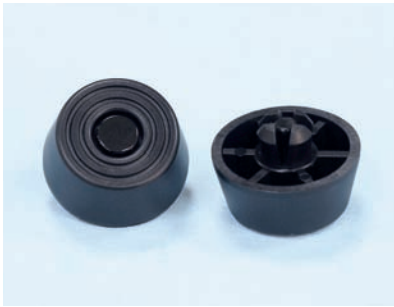

- Material: PE/TPR/TPV (UL)
- Flame Class: 94HB
- Pin Material: PP
- Color: Black/Gray/Computer
- Unit: mm

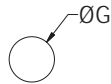
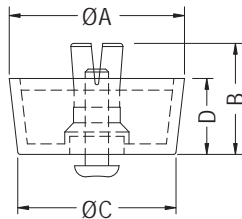

MOUNTING HOLE
CHASSIS THICKNESS: T

Part No.	A	B	C	D	G	T	Package
FF-1	20.8	11.8	19.8	6.4	8.0	1.0~2.5	500
FF-2	20.0	15.4	18.0	10.0	8.0	1.0~2.5	
FF-3	23.7	19.2	19.5	13.7	8.0	1.0~2.5	250
FF-4	25.0	12.5	23.5	6.5	8.0	1.0~2.5	500
FF-5	30.0	18.8	27.7	12.8	8.0	1.0~2.5	200
FF-6	28.5	14.0	26.5	8.2	10.0	1.0~3.5	250
FF-7	12.7	8.5	12.0	4.4	5.0	1.0~2.0	1000
FF-8	15.7	8.5	15.0	4.4	5.0	1.0~2.0	
FF-9	20.0	7.0	18.6	4.0	8.0	1.0~2.0	500
FF-10	23.8	10.0	22.0	5.0	8.0	1.0~2.5	
FF-11	31.5	13.6	28.5	7.8	10.0	1.0~3.5	250
FF-12	20.0	20.8	18.0	15.0	8.0	1.0~3.0	
FF-13	20.0	24.3	18.0	18.0	8.0	0.8~1.0	500
FF-14	19.5	10.5	18.7	5.0	8.0	0.8~2.0	500
FF-16	29.4	23.0	26.5	15.0	10.0	1.0~3.5	100
FF-19	20.0	9.1	18.0	6.0	4.0	0.8	1000
FF-20	20.0	8.4	18.0	5.2	5.0	0.8	
FF-21	20.0	25.6	19.3	20.5	8.0	0.8~2.0	250
FF-22	19.2	12.1	17.2	7.9	8.0	0.8~1.2	500
FF-24	23.0	13.3	21.0	8.0	8.0	0.8~2.0	
FF-25	24.0	15.8	20.0	10.5	8.0	0.8~2.0	250
FF-26	22.0	10.5	21.0	3.5	8.0	1.0~3.0	500
FF-27	26.7	21.0	24.8	16.0	8.0	1.0~3.0	200
FF-28	20.0	13.5	18.0	10.0	8.0	0.8~2.0	250
FF-31	27.0	12.0	26.0	6.9	10.0	0.8~2.0	
FF-34	41.2	21.6	40.0	14.0	10.0	0.8~2.0	100
FF-35	14.0	10.6	12.7	5.8	6.0	1.0~2.5	1000
FF-36	22.0	10.5	20.0	3.5	8.0	1.0~3.0	500
FF-41	20.8	12.6	19.8	7.2	8.0	1.0~2.5	
FF-43	12.0	10.0	10.5	5.8	5.0	1.0~2.5	1000
FF-44	20.8	11.8	19.8	6.9	8.0	1.0~2.5	500
FF-51	20.0	17.8	18.0	14.0	5.0	1.6	
FF-58	25.0	10.5	23.0	5.0	8.0	0.8~1.5	250



- Body Material: TPV
- Pin Material: PP
- Color: Black
- Unit: mm

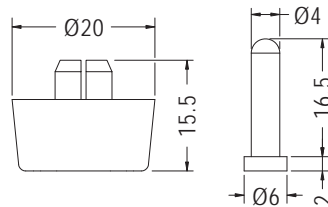

BODY

PIN

MOUNTING HOLE Ø8.0~Ø8.1
PANEL THICKNESS 0.8~1.5

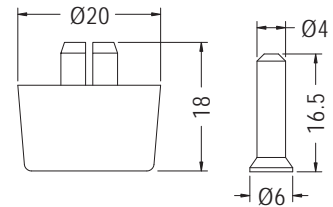

BODY

PIN

MOUNTING HOLE Ø8.0~Ø8.1
PANEL THICKNESS 0.5~1.2

Part No.	Part No.	Package
FF-56	FF-56A FF-56B	1000

Part No.	Part No.	Package
FF-57	FF-57A FF-57B	1000

腳墊 PLASTIC FOOT

用途：插銷式，可快速將腳墊固定於機殼，不脫落，耐重壓。



- Foot Material: TPE
- Pin Material: Nylon 66 (UL) 94V-2
- Color: Black
- Unit: mm

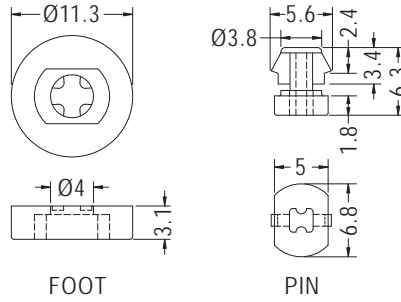

CHASSIS Ø4.0
THICKNESS 0.8-1.0

Part No.	Part No.	Package
FF-15	FF-15A FF-15B	1000



- Foot Material: TPE
- Rivet Material: Nylon 66 (UL) 94V-2
- Color: Black
- Unit: mm

用途：插銷式，可快速將腳墊固定於機殼，不脫落。

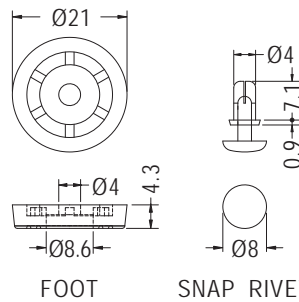

MOUNTING HOLE Ø4.0
THICKNESS 2.5

Part No.	Part No.	Package
FF-40F	FF-40A SR4-7	1000



- Foot Material: TPR
- Rivet Material: Nylon 66 (UL) 94V-2
- Color: Black
- Unit: mm

用途：插銷式，可快速將腳墊固定於機殼，不脫落，可更換鉚釘配合不同板厚。

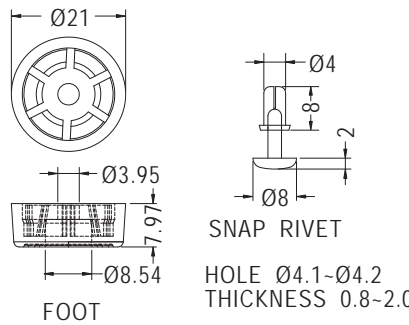

HOLE Ø4.1-Ø4.2
THICKNESS 0.8-2.0

Part No.	Part No.	Package
FF-46F	FF-46A SR4-71	1000

- Foot Material: TPV

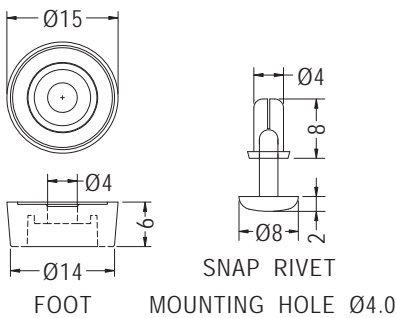

MOUNTING HOLE Ø4.0

Part No.	Part No.	Package
FF-47F	FF-47A SR4-7	1000

- Foot Material: TPE
- Rivet Material: Nylon 66 (UL)
- Flame Class: 94V-2/94V-0
- Color: Black
- Unit: mm

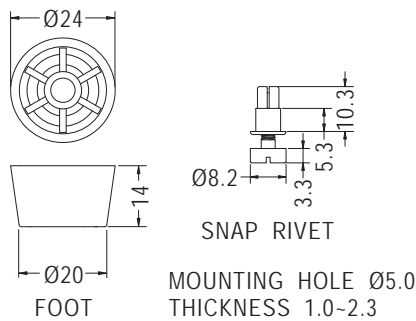

MOUNTING HOLE Ø5.0
THICKNESS 1.0-2.3

Part No.	Part No.	Package
FF-52F	FF-52A SRMB-1	1000

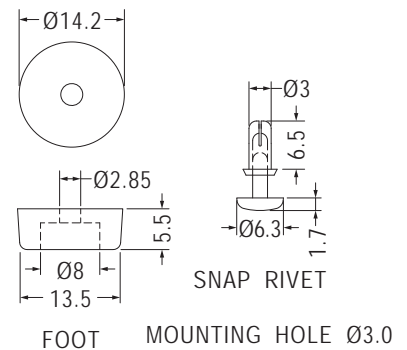

MOUNTING HOLE Ø3.0

Part No.	Part No.	Package
FF-55F	FF-55A SR3-5.5	1000

腳墊 PLASTIC FOOT



- Foot Material: TPV (UL)
- Rivet Material: Nylon 66 (UL)
- Flame Class: 94HB/94V-2/94V-0
- Color: Black
- Unit: mm

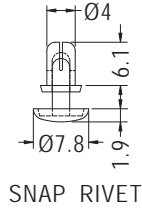
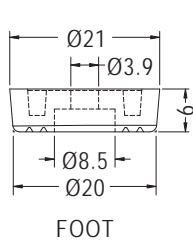

MOUNTING HOLE Ø4.1~Ø4.2
THICKNESS 0.8~1.8

Part No.	Part No.	Package
FF-59F	FF-59A SR4-6	1000

用途：插銷式，可快速將腳墊固定於機殼，不脫落，可更換鉚釘配合不同板厚。

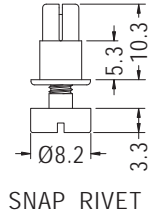
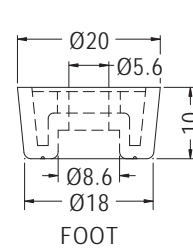

MOUNTING HOLE Ø5.0
THICKNESS 1.0~2.3

Part No.	Part No.	Package
FF-60F	FF-60A SRMB-1	1000

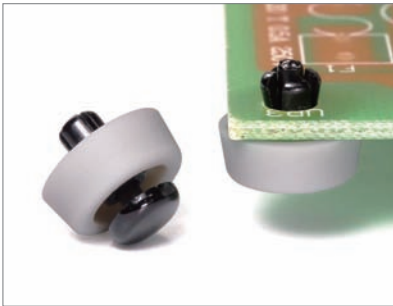

- Foot Material: TPE (UL)
- Rivet Material: Nylon 66 (UL)
- Flame Class: 94HB/94V-2
- Foot Color: Gray
- Rivet Color: Black
- Unit: mm

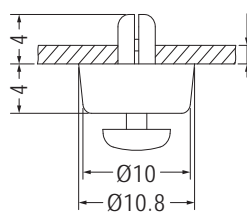

用途：插銷式，可快速將腳墊固定於機殼，不脫落。

THICKNESS 1.5~2.2



Part No.	Part No.	Package
FF-62F	FF-62A SR3.5-6	1000



- Material: TPE
- Color: Black
- Unit: mm

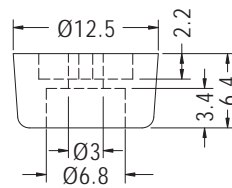

用途：可快速將腳墊固定於機殼，不脫落。

Part No.	Package
FF-37	1000



- Material: ABS/PP
- Color: Black
- Unit: mm

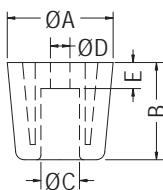

用途：機械外殼之座墊，使用螺絲固定，安全不脫落，耐重壓。

Part No.	A	B	C	D	E	Package
FFT-1	15.0	8.0	7.5	3.7	3.5	1000
FFT-2	20.0	12.1	8.2	4.1	5.5	500
FFT-3	25.1	16.2	10.4	4.3	8.1	100
FFT-4	24.4	22.4	8.9	4.6	6.0	
FFT-5	26.0	12.7	10.9	5.1	5.7	
FFT-6	22.5	22.4	8.6	4.6	6.0	
FFT-7	17.0	17.0	7.5	3.2	6.0	500
FFT-8	19.8	20.0	9.5	4.2	5.7	
FFT-9	20.0	12.8	9.5	3.6	5.7	
FFT-10	20.0	10.5	9.2	4.4	4.0	
FFT-11	28.5	8.2	11.29	7.1	6.0	100

腳墊 PLASTIC FOOT

用途：機械外殼之座墊，使用螺絲固定，安全不脫落，耐重壓。

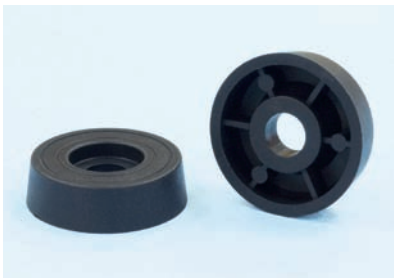

- Material: TPR
- Color: Black
- Unit: mm

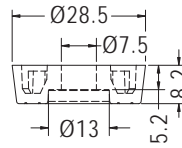

Part No.	Package
FFT-15	200



- Color: Black
- Unit: mm

用途：機械外殼之座墊，使用螺絲固定，安全不脫落。

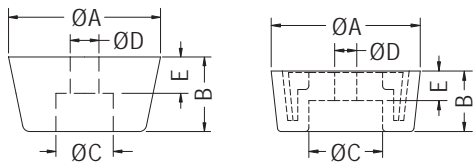

【 NF-001, NF-006, NF-007, NF-008, NF-008A, NF-014 】

Part No.	A	B	C	D	E	Material	Package
NF-001	14.8	7.0	6.0	3.0	3.1	PE	1000
NF-002	11.5	7.4	5.6	3.2	3.3	Rubber	
NF-004	16.0	7.8	6.0	3.0	3.5	Rubber	
NF-005	17.2	7.0	9.0	4.0	3.0	Rubber	500
NF-006	20.2	8.0	10.0	3.0	4.0	PE	
NF-007	25.0	5.8	8.5	3.3	2.8	PE	
NF-007I	25.0	5.8	8.5	3.3	3.0	Silicon Rubber	1000
NF-008	20.0	10.5	9.8	3.0	5.0	PE	
NF-008A	20.0	10.5	9.8	4.0	5.0	PE	
NF-009	11.0	5.7	6.0	3.5	2.3	PE/PP	100
NF-013	18.0	9.8	7.8	3.5	2.7	PP	
NF-014	28.0	20.0	9.7	3.8	6.0	PE/PP	
NF-018	28.0	25.0	9.7	4.2	6.0	Rubber	100
NF-020	20.2	15.0	9.4	3.5	4.0	Rubber	
NF-046	22.0	14.0	9.5	4.0	6.5	Rubber	

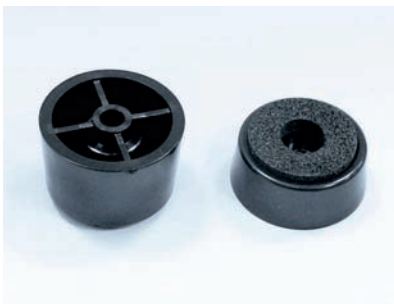

- Material: ABS
- Color: Black
- Unit: mm

用途：螺絲式，將腳墊固定於機殼，下有泡棉或矽膠，抗滑性佳。

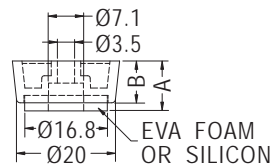
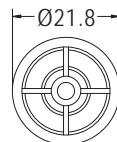

Part No.	A	B	Package
FFS-1	10.0	8.5	500
FFS-2	15.0	13.5	

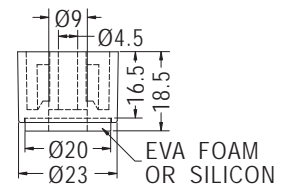

Part No.	Package
FFS-5	500



- Housing Material: TPR
- Color: Black
- Unit: mm

用途：機械外殼之座墊，使用螺絲固定，安全不脫落，耐重壓。

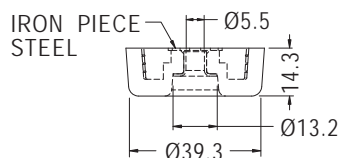
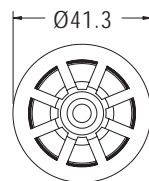

Part No.	Package
FFR-1	50

腳墊 PLASTIC FOOT



- Material: TPE
- Color: Black
- Unit: mm

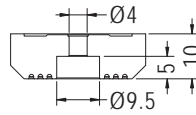
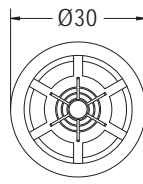

Part No.	Package
FFP-30	250

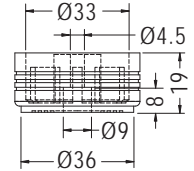
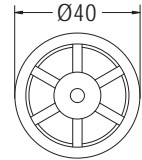

Part No.	Package
FFP-40	50

用途：機械外殼之座墊，使用螺絲固定，安全不脫落，耐重壓。

橡膠腳墊 RUBBER FOOT



- Material: Rubber
- Color: Black
- Unit: mm

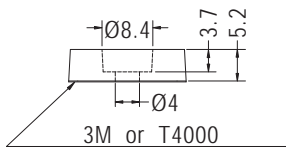
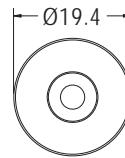

3M or T4000
DOUBLE ADHESIVE TAPE
高度尺寸不含背膠

Part No.	Package
TF-605	1000

用途：用於機器、電子儀器之腳墊，可自黏或螺絲固定兩用。

抗震腳墊 ANTI-VIBRATION FOOT

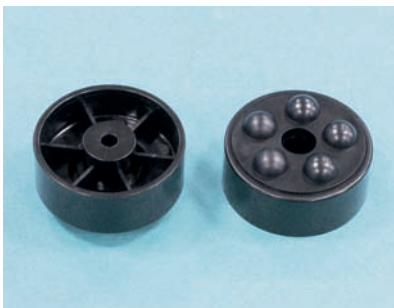

- Body Material: ABS
- Pad Material: TPE
- Color: Black
- Unit: mm

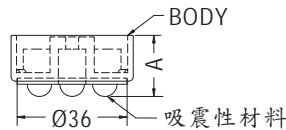
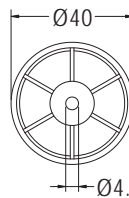

Shock Absorbing Materials.

Part No.	A	Package
FFQ-1	20.0	500
FFQ-2	12.0	

用途：特殊吸震材料，用於需抗震之重低音音響、影碟機等之防震腳墊，裝配容易、美觀防震性佳。

腳墊 PLASTIC FOOT



- Housing Material: ABS (UL)
- Housing Flame Class: 94HB
- Color: Black
- Unit: mm

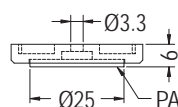
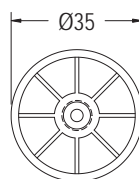

PAD MATERIAL: RUBBER

Part No.
FFK-5(RU)

用途：用於音響、影碟機等之腳墊，裝配容易、美觀。

腳墊 PLASTIC FOOT

用途：用於音響、影碟機等之腳墊，裝配容易、美觀。



- Housing Material: ABS
- Color: Black
- Unit: mm

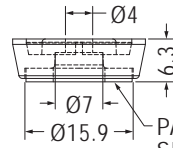
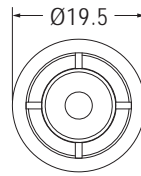

PAD MATERIAL:
SILICON RUBBER

Part No.
FFK-6I



- Housing Material: ABS
- Color: Black
- Unit: mm
- FFK Series: Without Silver/Gold Covering

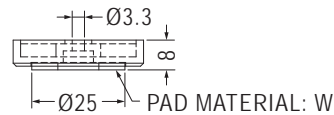
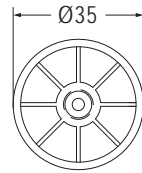

PAD MATERIAL: W

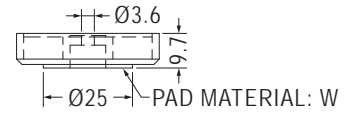
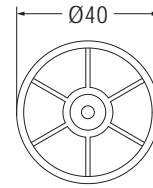

PAD MATERIAL: W

- FFK-4P: 外部霧面處理
- FFK-4P: Matte finished surface

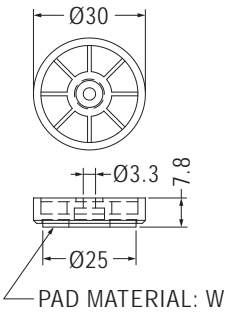

PAD MATERIAL: W

Part No.	W
FFK-1	EVA
FFK-1P	Poron
FFK-1(RU)	Rubber

Part No.	W
FFK-3	EVA
FFK-3P	Poron
FFK-3(RU)	Rubber

Part No.	W
FFK-2	EVA
FFK-2P	Poron
FFK-2(RU)	Rubber
FFK-4P	Poron

銀框腳墊 SILVER COVERING FOOT

用途：用於音響、影碟機等之腳墊，裝配容易、美觀。



- Housing Material: ABS
- Color: Black
- Unit: mm

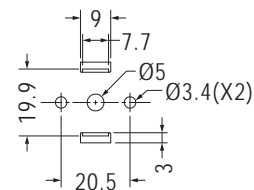
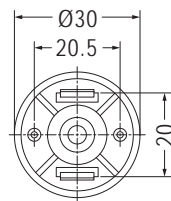

MOUNTING HOLE

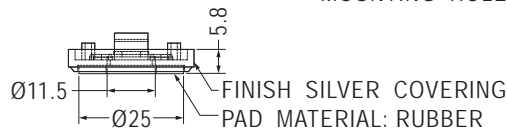

FINISH SILVER COVERING
PAD MATERIAL: RUBBER

Part No.
FFH-30S(RU)

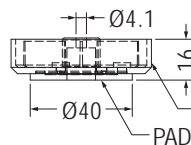
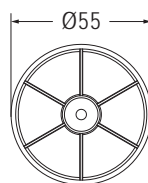

FINISH: F
PAD MATERIAL: TPE

Part No.	F
RS-61N	
RS-61S	Silver Covering

銀框腳墊 SILVER COVERING FOOT



- Housing Material: ABS (UL)
- Flame Class: 94HB
- Color: Black
- Unit: mm

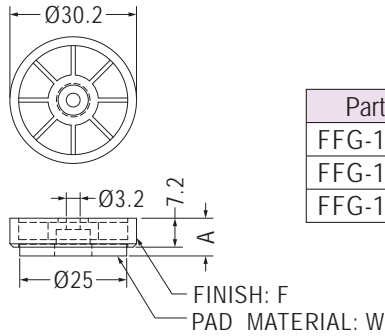

Part No.	A	F	W
FFG-1A	9.1	Silver Covering	EVA
FFG-1A(N)	9.1		EVA
FFG-1A(RU)	8.2	Silver Covering	Rubber

用途：用於音響、影碟機等之腳墊，裝配容易、美觀。

金框腳墊 GOLD COVERING FOOT



- Housing Material: ABS
- Color: Black
- Unit: mm

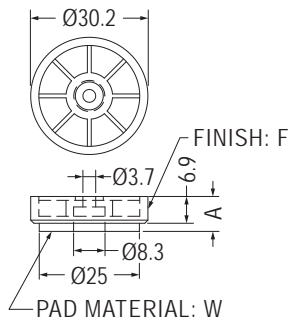

Part No.	A	F	W
FFG-1	9.0	Silver Covering	EVA
FFG-1(RU)	8.0	Silver Covering	Rubber
FFG-1G(RU)	8.0	Gold Covering	Rubber
FFG-1N		Silver Covering	

用途：用於音響、影碟機等之腳墊，裝配容易、美觀。

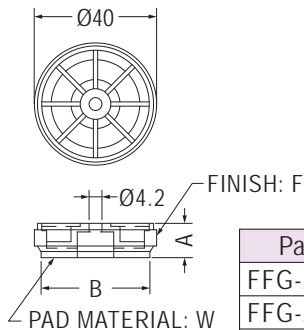

Part No.	A	B	F	W
FFG-2A	10.8	35.5	Gold Covering	EVA
FFG-2A(RU)	10.2	35.5	Gold Covering	Rubber
FFG-2A(S)	11.0	35.0	Silver Covering	EVA
FFG-2AS(RU)	10.2	35.5	Silver Covering	Rubber

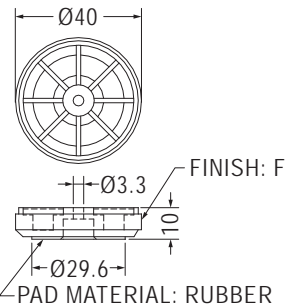

Part No.	F
FFG-2	Gold Covering
FFG-2(S)	Silver Covering

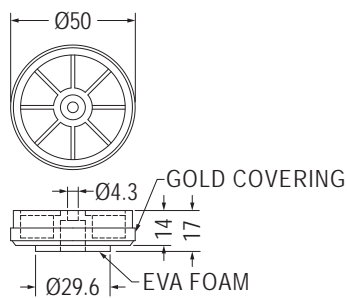

Part No.
FFG-3

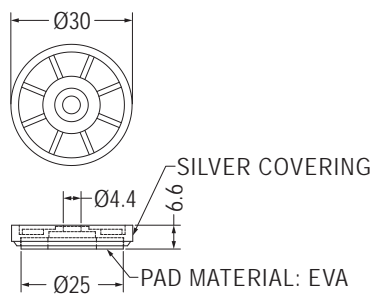

Part No.
FFG-30(S)

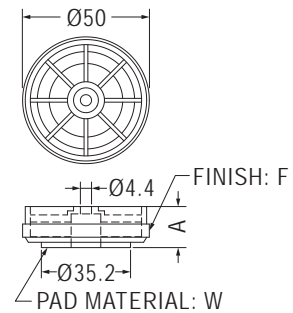

Part No.	A	F	W
FFG-3A	16.2	Gold Covering	EVA
FFG-3A(RU)	15.4	Gold Covering	Rubber
FFG-3A(S)	16.0	Silver Covering	EVA
FFG-3A(G)N		Gold Covering	
FFG-3AN	16.2		EVA
FFG-3AN(RU)	15.4		Rubber

金框腳墊 GOLD COVERING FOOT

用途：用於音響、影碟機等之腳墊，裝配容易、美觀。

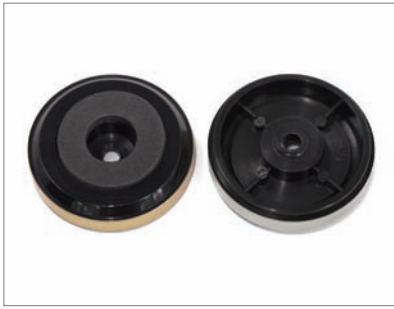

- Housing Material: ABS
- Color: Black
- Unit: mm

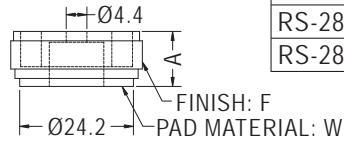
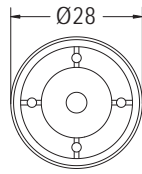

Part No.	A	F	W
RS-28	11.7	Golden Alum. Covering	EVA
RS-28(S)	11.7	Silver Alum. Covering	EVA
RS-28S(RU)	10.7	Silver Alum. Covering	Rubber
RS-28N(RU)	10.7		Rubber
RS-28(N)N	10.0		

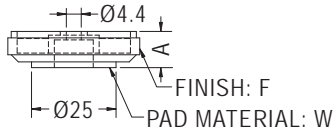
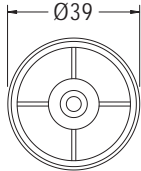

Part No.	A	F	W
RS-40	10.7	Golden Alum. Covering	EVA
RS-40(S)	10.7	Silver Alum. Covering	EVA
RS-40S(RU)	9.8	Silver Alum. Covering	Rubber

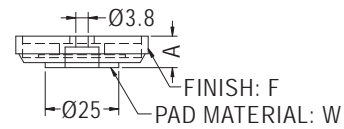
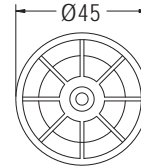

Part No.	A	F	W
RS-45	10.7	Golden Alum. Covering	EVA
RS-45(S)	10.7	Silver Alum. Covering	EVA
RS-45(RU)	9.7	Golden Alum. Covering	Rubber
RS-45S(RU)	9.7	Silver Alum. Covering	Rubber
RS-45(S)I	9.7	Silver Alum. Covering	Silicon Rubber

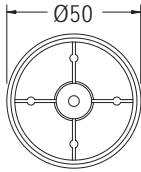

Part No.	A	F	W
RS-50	14.8	Gold Covering	EVA
RS-50(RU)	14.0	Gold Covering	Rubber
RS-50N	14.8		EVA
RS-50N(RU)	14.0		Rubber
RS-50(S)	14.8	Silver Covering	EVA
RS-50S(RU)	14.0	Silver Covering	Rubber

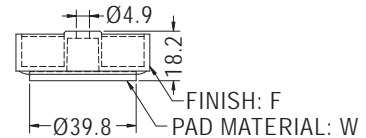
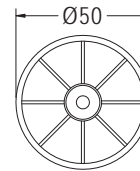

Part No.	F	W
RS-50-2	Golden Alum. Covering	EVA

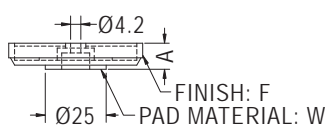
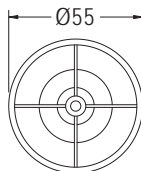

Part No.	A	F	W
RS-55	10.7	Golden Alum. Covering	EVA
RS-55(S)	10.7	Silver Alum. Covering	EVA
RS-55S(RU)	9.7	Silver Alum. Covering	Rubber

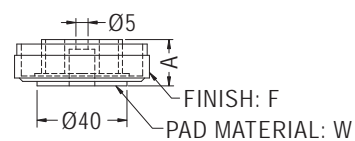
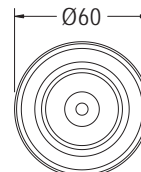

Part No.	A	F	W
RS-60N	20.0		EVA
RS-60	20.0	Golden Alum. Covering	EVA
RS-60(BK)	20.0	鍍黑灰色 Dark Gray Covering	EVA
RS-60(S)	20.0	Silver Alum. Covering	EVA
RS-60(S)RU	19.3	Silver Alum. Covering	Rubber

金框腳墊 GOLD COVERING FOOT

用途：用於音響、錄影機等之腳墊，裝配容易、美觀。

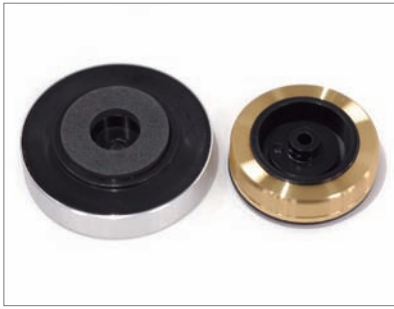

- Housing Material: ABS
- Metal Material: AL
- Color: Black
- Unit: mm

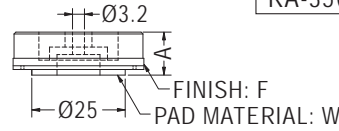
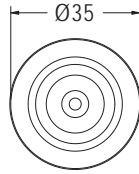

Part No.	A	F	W
RA-35	11.5	Golden Alum. Covering	EVA
RA-35(S)	11.5	Silver Alum. Covering	EVA
RA-35(S)RU	10.5	Silver Alum. Covering	Rubber

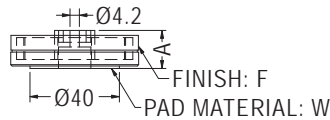
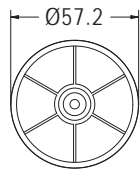

Part No.	A	F	W
RA-57	17.0	Golden Alum. Covering	EVA
RA-57(RU)	17.1	Golden Alum. Covering	Rubber
RA-57(S)	17.0	Silver Alum. Covering	EVA
RA-57S(RU)	17.1	Silver Alum. Covering	Rubber

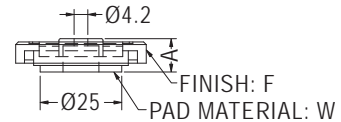
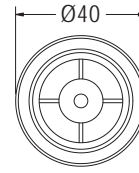

Part No.	A	F	W
RA-40	12.0	Golden Alum. Covering	EVA
RA-40(RU)	11.0	Golden Alum. Covering	Rubber
RA-40(S)	12.0	Silver Alum. Covering	EVA
RA-40S(RU)	11.0	Silver Alum. Covering	Rubber
RA-40(K)	12.0	Champagne Color	EVA

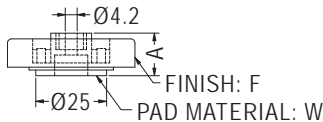
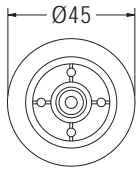

Part No.	A	F	W
RA-45	15.0	Golden Alum. Covering	EVA
RA-45(S)	15.0	Silver Alum. Covering	EVA
RA-45(RUS)	14.0	Silver Alum. Covering	Rubber
RA-45S(RU)	14.1	Silver Alum. Covering	Rubber
RA-45S(I)	14.1	Silver Alum. Covering	Silicon Rubber

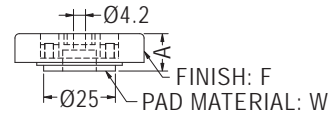
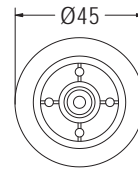

Part No.	A	F	W
RA-45S-1	12.5	Silver Alum. Covering	EVA
RA-45-1(RU)	11.5	Golden Alum. Covering	Rubber
RA-45S-1(RU)	11.5	Silver Alum. Covering	Rubber

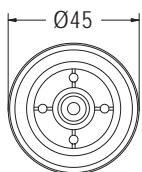

Part No.
RA-45S-3

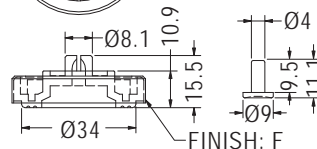
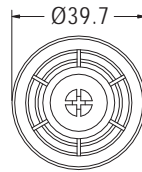

MOUNTING HOLE Ø8.0

- Foot Material: PE
- Pin Material: PP

Part No.	F
RAFF-40	Golden Alum. Covering
RAFF-40(S)	Silver Alum. Covering
RAFF-40(B)	Black Alum. Covering

橡膠腳墊 RUBBER FOOT

用途：可快速將腳墊固定於機殼，裝配容易，不脫落。



- Material: Rubber
- Color: Black
- Unit: mm

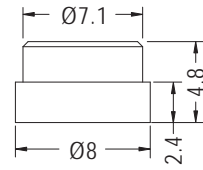

MOUNTING HOLE Ø7.0

Part No.	Package
TF-017	1000



- Material: Rubber
- Color: Black
- Unit: mm

用途：用於機殼之座墊，裝配容易安全不脫落。

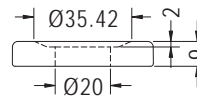
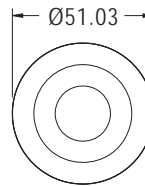

Part No.	Package
TF-448	500

矽膠腳墊 SILICON RUBBER FOOT

用途：可快速將腳墊固定於機殼，裝配容易，不脫落。



- Material: Silicon Rubber
- Color: Black
- Unit: mm

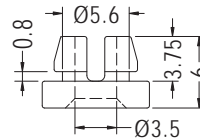

Part No.	Package
TF-561	1000

腳墊 PLASTIC FOOT

用途：固定於機殼，保護用。



- Material: TPR
- Color: Black
- Unit: mm

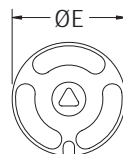

HOLE IN CHASSIS

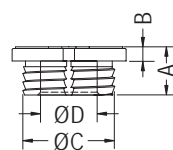

Part No.	A	B	C	D	E	G	Package
TFF-1	9.0	3.0	16.3	10.0	20.0	16.0	1000
TFF-2	8.5	2.5	16.3	10.0	20.0	16.0	
TFF-3	9.0	2.4	20.2	13.5	22.8	19.8	
TFF-5	7.5	2.5	16.3	10.0	20.0	16.0	

腳墊 PLASTIC FOOT

用途：可快速將腳墊固定於機殼，裝配容易，不脫落。



- Material: TPR
- Color: Black
- Unit: mm

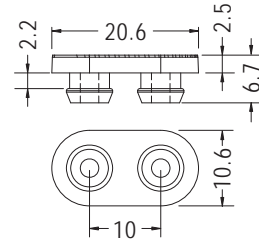

MOUNTING HOLE $\varnothing 5.6$
THICKNESS 2.0

Part No.	Package
TNFF-1	1000

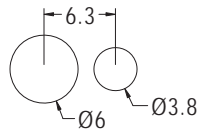
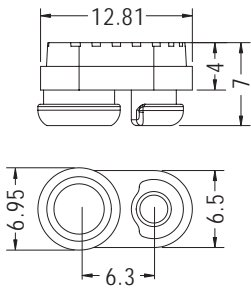

MOUNTING HOLE $\varnothing 5.6$
CHASSIS THICKNESS 1.0-1.2

Part No.	Package
TNFF-2	1000

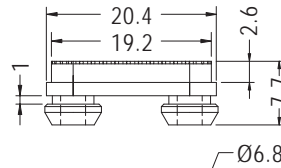

MOUNTING HOLE $\varnothing 5.0$

Part No.	Package
TNFF-3	1000

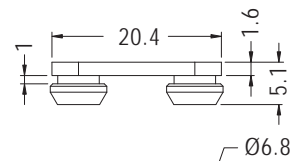

MOUNTING HOLE $\varnothing 5.0$

Part No.	Package
TNFF-4	1000



- Material: Silicon Rubber (UL)
- Flame Class: 94HB/94V-0
- Color: Black
- Unit: mm

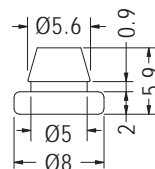

MOUNTING HOLE $\varnothing 4.5-5.0$

Part No.	Package
TNF-7	2000

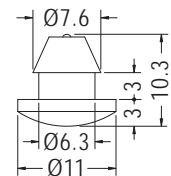

MOUNTING HOLE $\varnothing 6.3$

Part No.	Package
TNF-44	2000

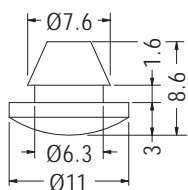

MOUNTING HOLE $\varnothing 6.5$

- Material: Rubber

Part No.	Package
TNF-6	2000

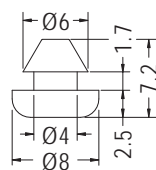

MOUNTING HOLE $\varnothing 4.2$

Part No.	Package
TNF-5	1000

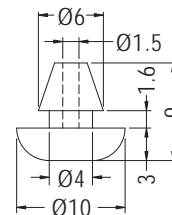

MOUNTING HOLE $\varnothing 4.0$

- Material: Neoprene

Part No.	Package
TNF-41	1000

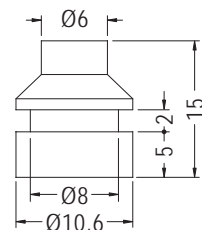

MOUNTING HOLE $\varnothing 8.2$

Part No.	Package
TNF-2	1000

腳墊 PLASTIC FOOT

用途：可快速將腳墊固定於機殼，裝配容易，不脫落。



- Material: Rubber
- Color: Black
- Unit: mm

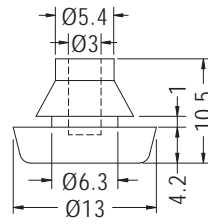

MOUNTING HOLE Ø6.35

Part No.	Package
TNF-3	1000

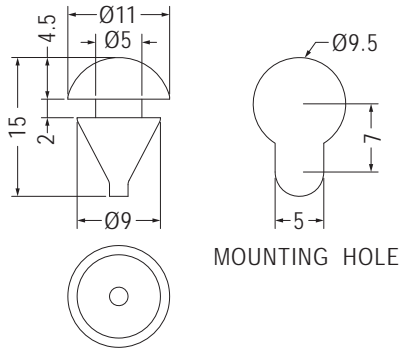

MOUNTING HOLE

- Material: TPE
- Color: White

Part No.	Package
TNF-40	1000

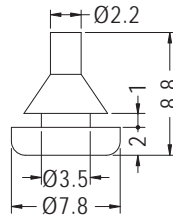

MOUNTING HOLE Ø3.5

- Material: EPDM

Part No.	Package
TF-546	1000

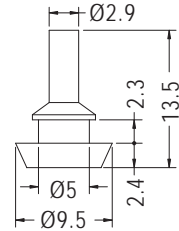

MOUNTING HOLE Ø5.2

Part No.	Package
TNF-1	1000

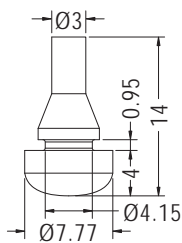

MOUNTING HOLE Ø4.2

- Material: Silicon Rubber

Part No.	Package
TF-041	1000

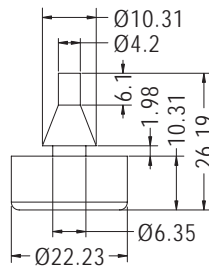

MOUNTING HOLE Ø8.0
THICKNESS 2.0

- Material: Neoprene

Part No.	Package
TNF-15	500

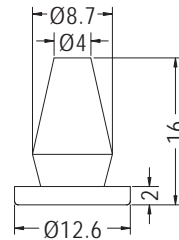

MOUNTING HOLE Ø7.0

Part No.	Package
TNF-47	1000

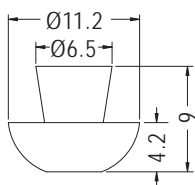

MOUNTING HOLE Ø5.0

Part No.	Package
TNF-46	1000

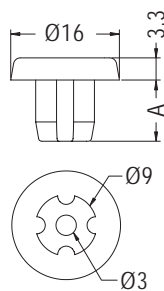

MOUNTING HOLE Ø8.3-Ø8.5

Part No.	A	Package
TNF-9	9.0	2000
TNF-19	6.5	

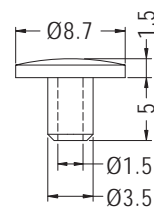

MOUNTING HOLE Ø3.5

Part No.	Package
TF-283	1000

腳墊 PLASTIC FOOT



- Material: TPE
- Color: Black
- Unit: mm

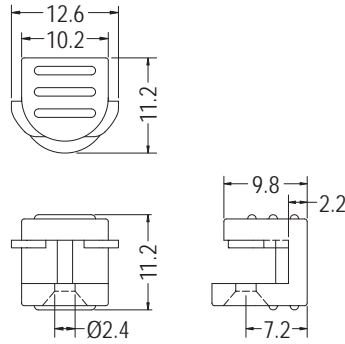

Part No.	Package
DELT-21	1000

用途：可快速將腳墊固定於機殼，裝配容易，不脫落。

橡膠腳墊 RUBBER FOOT



- Material: Rubber
- Color: Black
- Unit: mm

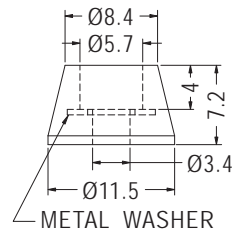

Part No.	Package
NF-002ST	1000

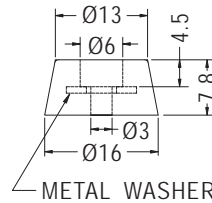

Part No.	Package
NF-004ST	1000

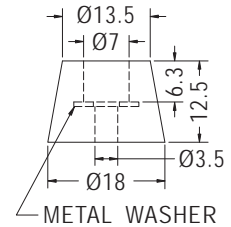

Part No.	Package
NF-039ST	1000

用途：機械外殼之座墊，內含有鐵華司，使用螺絲固定，安全不脫落，耐重壓。

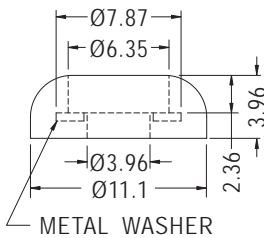

Part No.	Package
NF-011ST	1000

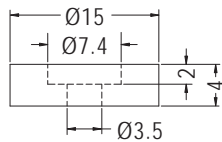

Part No.	Package
NF-012	1000

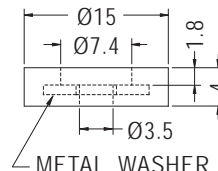

Part No.	Package
NF-012ST	1000

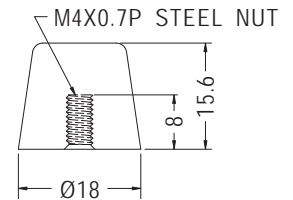

Part No.	Package
NF-051ST	1000

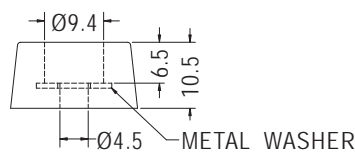
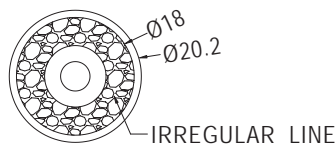

Part No.	Package
NF-015ST	1000

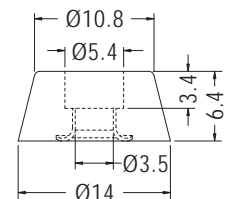

- Metal Ring Material: Bronze

Part No.	Package
NF-016ST	1000

橡膠腳墊 RUBBER FOOT



- Material: Silicon Rubber (UL)/Rubber
- Flame Class: 94HB
- Color: Black
- Unit: mm

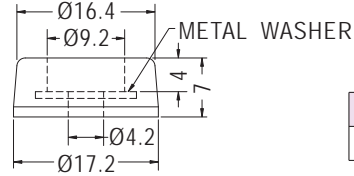

Part No.	Package
NF-005ST	1000

用途：機械外殼之座墊，內含有鐵華司，使用螺絲固定，安全不脫落，耐重壓。

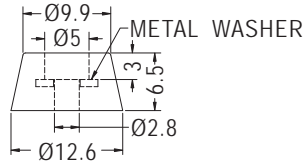

Part No.	Package
NF-030IST	1000

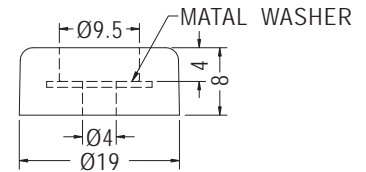

Part No.	Package
NF-047ST	1000

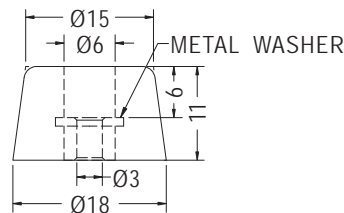

Part No.	Package
NF-035IST	1000

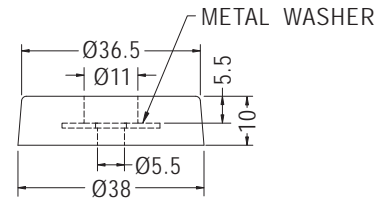

- Material: Rubber

Part No.	Package
NF-050ST	250

腳墊 PLASTIC FOOT



- Material: TPE
- Color: Black
- Unit: mm

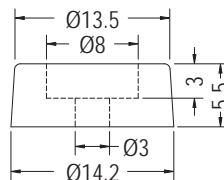

Part No.	Package
NF-031	1000

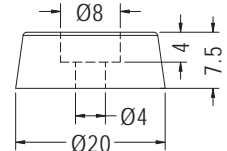

- Material: Rubber

Part No.	Package
NF-045	1000

用途：機械外殼之座墊，使用螺絲固定，安全不脫落，耐重壓。

磁鐵腳墊 MAGNET PLASTIC FOOT



- Foot Material: Nylon 66 (UL)
- Magnet Material: NdFeB
- Flame Class: 94V-2/94V-0
- Color: Natural/Black
- Unit: mm

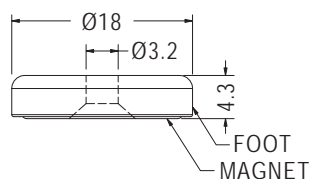

Part No.	Package
MGFA-2	1000

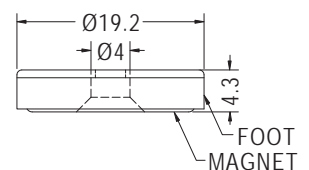

- Foot Material: Steel

Part No.	Package
MGFF-4	1000

用途：磁鐵腳墊，可將HUB吸著於鐵板上。

腳墊 PLASTIC FOOT



- Material: PE
- Color: Black
- Unit: mm

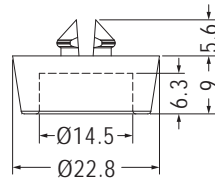

MOUNTING HOLE Ø8.0

用途：用於機殼之座墊，裝配容易、安全不脫落。

Part No.	Package
GL-4	500

矽膠腳墊 SILICON RUBBER FOOT



- Material: Silicon Rubber
- Body Material: Nylon 66 (UL)94V-2
- Color: Gray
- Body Color: Black
- Unit: mm

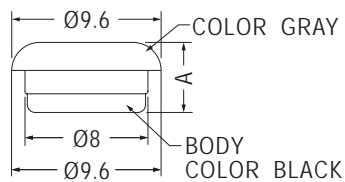

用途：做為腳墊止滑用。

Part No.	A	Package
FFDA-9AY	4.5	2000
FFDA-10AY	4.55	

腳墊 PLASTIC FOOT

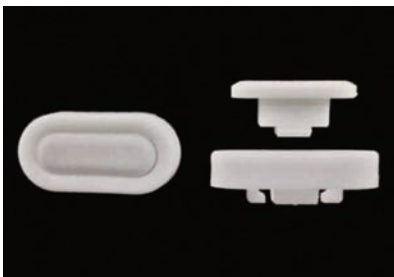

- Body Material: TPR
- Pin Material: ABS (UL) 94HB
- Color: Black/White
- Unit: mm

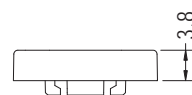
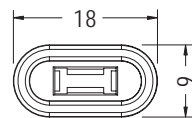

BODY

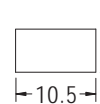

MOUNTING HOLE THICKNESS 0.8

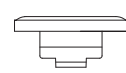
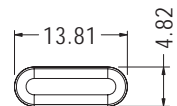

PIN

Part No.	Package
ASFF-1A	1000

Part No.	Package
ASFF-1B	1000

用途：電腦外殼之座墊，使用插銷固定，安全不脫落。



- Material: TPR
- Metal Ring Material: SPCC
- Color: Gray
- Unit: mm

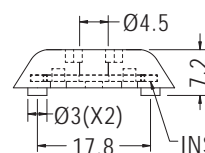
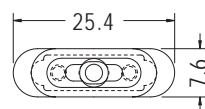

INSERT IRON PIECE

用途：機械外殼之座墊，內含有鐵件，使用螺絲固定，安全不脫落，耐重壓。

Part No.	Package
TF-356	1000

橡膠腳墊 RUBBER FOOT

用途：背膠式，可快速將腳墊固定於機殼，黏性佳、不脫落。



- Material: Rubber
- Color: Black
- Unit: mm

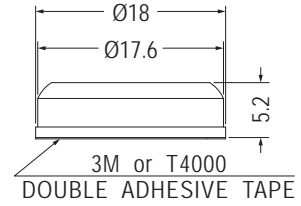
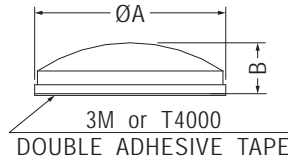

Part No.	A	B
RF-004	9.9	3.8
RF14-5A	14.0	5.0
RF27-7AC-1	27.8	7.4

Part No.
RF18-5A



- Material: Rubber/Silicon Rubber
- Color: Black
- Unit: mm

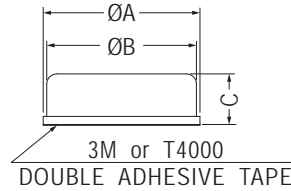

Part No.	A	B	C
RF5.8-4A	5.8	5.5	4.0
RF8-3.5	8.0	7.7	3.5
RF8.2-5	8.2	7.6	5.0
RF9-3.5	9.0	8.2	3.5
RF9.7-4.2A	9.7	9.3	4.2
RF15.5-5A	15.4	14.8	5.1
RF19-4A7	19.05	18.05	4.06
RF22.8-5	22.8	22.4	5.0
RF22-8.8	22.0	21.0	8.8
RF22-5	22.0	21.0	5.0



- Material: Rubber/Silicon Rubber
- Color: Black
- Unit: mm
- Other Materials Available: EPDM

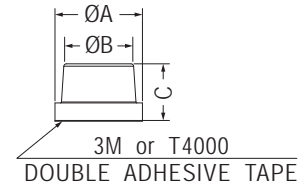
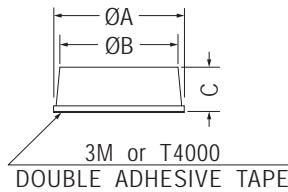

【 RF7-4.2A, RF8-6.5A, RF10-6.2A, RF12.7-6.2A, RF15-13.5A, RF17-11A 】

Part No.	A	B	C
RF6-5	6.0	5.0	5.0
RF7-4.2A	7.0	6.5	4.2
RF7-3.2A	7.0	6.6	3.2
RF8-6.5A	8.0	7.2	6.5
★RF10-6.2A	10.0	7.5	6.2
RF-1094A	10.0	9.0	9.4
RF-003	10.0	9.5	4.2
RF-030	10.0	9.5	8.0
RF-1055	10.0	9.7	5.5
RF-009	10.8	10.2	3.0
RF11-5	11.0	9.6	5.0
RF-011	11.0	10.5	5.0
RF11-3.2A	11.3	10.7	3.2
RF-039	11.9	11.2	6.4
RF12-27A	12.0	11.6	2.7

Part No.	A	B	C
RF-015	12.0	11.2	5.1
RF-019	12.0	9.5	4.0
RF-019A	12.7	10.0	3.8
RF12.7-6.2A	12.7	10.0	6.2
RF-032	12.7	11.5	4.0
RF-005	13.0	11.4	5.0
RF-012	13.0	12.2	4.5
RF15-11A	15.0	13.5	11.0
★RF15-13.5A	15.0	13.5	13.5
RF17-11A	17.0	13.25	11.0
RF-007	19.0	17.0	7.2
RF-020	19.0	15.8	4.2
RF20-5	19.8	18.0	5.0
RF-008	20.0	19.0	6.0
RF24-8	24.0	20.0	8.0

橡膠腳墊 RUBBER FOOT

用途：背膠式，可快速將腳墊固定於機殼，黏性佳、不脫落。



- Material: Rubber/Silicon Rubber
- Color: Black
- Unit: mm
- Other Materials Available: EPDM

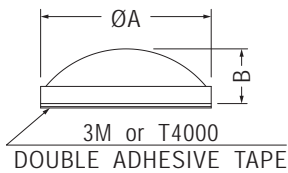

Part No.	A	B
RF-002	10.0	2.8
RF8-2A	8.0	2.0
RF8-2.6A	8.0	2.6
RF8-3A	8.0	3.0
RF8.8-2.9A	8.8	2.89
RF21.6-11A	21.6	11.0

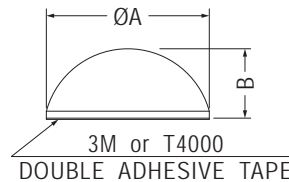

Part No.	A	B
RF-021	6.7	4.2
RF7.8-2.9A	7.8	2.9
RF9.5-3.9A	9.5	3.9
RF-1106	11.0	6.0
RF-022	11.3	5.6
RF14-8A	14.0	8.0
RF-006	15.9	8.0
RF21-8.5	21.6	8.52
RF21-10	21.6	10.0



- Material: Rubber
- Color: Black
- Unit: mm

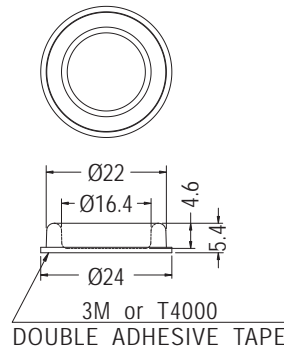

Part No.
RF-031

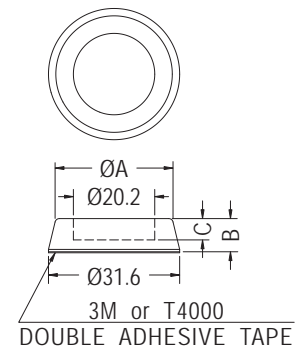

Part No.	A	B	C
RF-016	29.6	6.6	4.1
RF-017	29.0	8.8	4.9

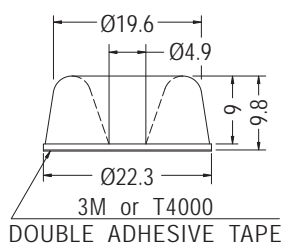

Part No.
RF-018

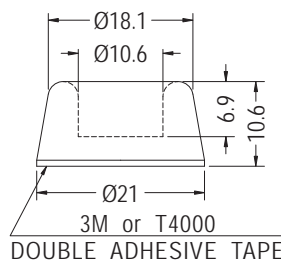

Part No.
RF20-10

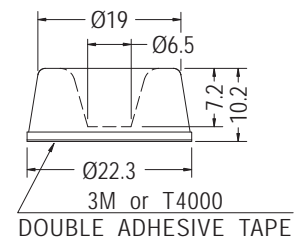

Part No.
RF-029

橡膠華司 RUBBER WASHER

用途：做為零件之墊片。



- Material: Rubber
- Color: Black
- Unit: mm

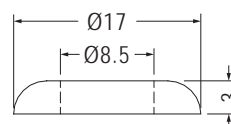

Part No.
RWF8.5-3N

橡膠華司 RUBBER WASHER

用途：背膠式，可快速將腳墊固定於機殼，黏性佳、不脫落。

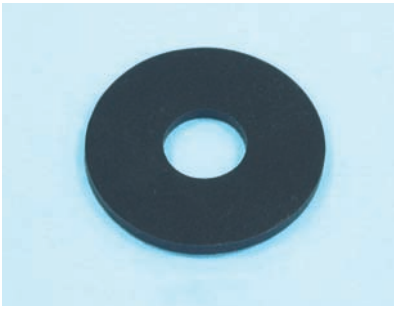

- Material: Rubber/Silicon Rubber
- Color: Black
- Unit: mm

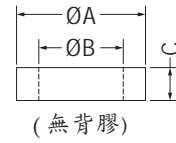
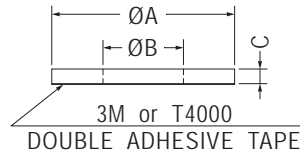

【 RWF7.6-1.7N, RWF7.2-2.8N 】

Part No.	A	B	C
RWF3.5-0.5	8.0	3.5	0.5
RWF3.5-1	8.0	3.5	1.0
RWF4.5-2	8.0	4.5	2.0
★RWF7.6-1.7N	10.9	7.6	1.7
RWF3.5-1.5	11.0	3.5	1.5
★RWF7.2-2.8N	11.0	7.2	2.8

Part No.	A	B	C
RWF4.5-3	15.0	4.5	3.0
RWF18-8.5-15	18.0	8.5	1.5
RWF20-1.5	20.0	6.0	1.5
RWF25-2	25.0	11.0	2.0
RWF10.2-2	29.6	10.2	2.0
RWF40-2	40.0	12.0	2.0
RWF43-2	43.0	30.1	2.0

橡膠墊圈 O-RING

用途：做為零件之油封或墊片。



- Material: NBR/EPDM/Silicon Rubber
- Color: Black
- Unit: mm

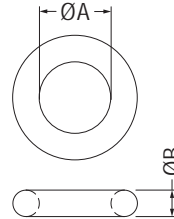

Part No.	A	B	Package
OR-1.7	1.7	0.6	2000
OR-2	2.0	1.0	
OR-2.7	2.75	0.6	
OR-2.8	2.8	0.5	
OR-2.9	2.9	1.78	
OR-3.6	3.6	1.78	
OR-4	4.0	2.0	
OR-4.6	4.6	1.78	
OR-5	5.0	1.0	
OR5.5-11.8	5.5	3.15	
OR-5.8	5.8	1.9	

Part No.	A	B	Package
OR-6	6.02	2.6	2000
OR6.07-1.63	6.07	1.63	
OR7-2	7.0	2.0	
OR-7.6	7.65	1.78	
OR-7.9	7.9	1.0	
OR-11	11.0	2.0	
OR-88	20.0	1.0	
OR-21.3	21.3	3.0	
OR-25.2	25.2	3.5	
OR-84.4	84.4	3.1	

矽膠墊圈 O-RING

用途：做為零件之油封或墊片。



- Material: Silicon Rubber
- Color: Black
- Unit: mm

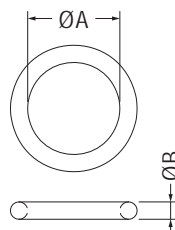

Part No.	A	B	Package
OR2.4-1.9	2.4	1.9	2000
OR2.6-1.1	2.6	1.1	
OR8-1.5	8.0	1.5	
OR10.5-1	10.5	1.0	
OR10.6-1.25	10.6	1.25	
OR15-1.5	15.0	1.5	
OR-31-1.8	31.47	1.78	

橡膠腳墊 RUBBER FOOT

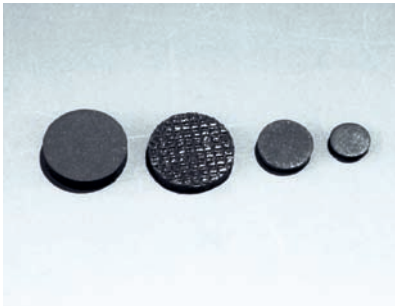

- Material: Rubber/Silicon Rubber
- Color: Black
- Unit: mm
- Other Materials Available:
EPDM, Poron
- Optional Thickness: 0.5-3.2mm

用途：背膠式，可快速將腳墊固定於機殼，黏性佳、不脫落。

可依客戶指定長、寬、高裁切成各種形狀，如方形、圓形。表面可分為平面、斜紋等。

Different size available per request.

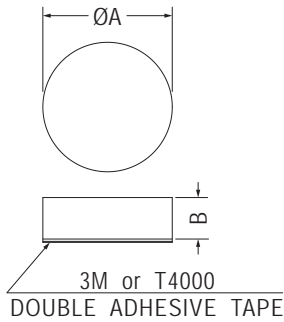

Part No.	A	B
RF3.8-2	3.8	2.0
RF0415	4.0	1.5
RF4-0.5	4.0	0.5
RF4-0.6	4.0	0.6
RF4-3	4.0	3.0
RF4.5-1.5	4.5	1.5
RF4.5-2.7	4.5	2.7
RF4.8-1	4.8	1.0
RF5-1.5	5.0	1.5
RF5-2	5.0	2.0
RF5-2.5	5.0	2.5
RF5-3.5	5.0	3.5
RF5.3-0.7	5.3	0.7
RF5.5-1.6	5.5	1.6
RF5.6-2	5.6	2.0
RF6-0.5	6.0	0.5
RF6-0.8	6.0	0.8
RF6-0.9	6.0	0.9
RF6-1	6.0	1.0
RF6-1.3	6.0	1.3
RF6-1.5	6.0	1.5
RF6-2	6.0	2.0
RF6-2.5	6.0	2.5
RF6-3	6.0	3.0
RF6-3.5	6.0	3.5
RF6.4-2.6	6.4	2.6
RF6.5-1	6.5	1.0
RF6.5-2.5	6.5	2.5
RF6.6-1.5	6.6	1.5
RF6.6-1.8	6.6	1.8
RF6.6-2	6.6	2.0
RF7-0.5	7.0	0.5
RF7-0.9	7.0	0.9
RF7-1	7.0	1.0
RF7-1.5	7.0	1.5
RF7-2	7.0	2.0
RF7-2.5	7.0	2.5
RF7-2.7	7.0	2.7
RF7-3	7.0	3.0
RF7.2-1.5	7.2	1.5
RF7.5-2	7.5	2.0

Part No.	A	B
RF-001	8.0	1.8
RF8-0.5	8.0	0.5
RF8-1	8.0	1.0
RF8-1.4	8.0	1.4
RF8-1.5	8.0	1.5
RF8-2	8.0	2.0
RF8-2.5	8.0	2.5
RF8-3	8.0	3.0
RF8.5-1.5	8.5	1.5
RF8.5-2	8.5	2.0
RF9-1	9.0	1.0
RF9-1.2	9.0	1.2
RF9-1.5	9.0	1.5
RF9-2	9.0	2.0
RF9-2.5	9.0	2.5
RF9-3	9.0	3.0
RF9.5-0.8	9.5	0.8
RF9.5-1.5	9.5	1.5
RF9.5-1.8	9.5	1.8
RF9.5-2	9.5	2.0
RF9.5-3	9.5	3.0
RF10-0.8	10.0	0.8
RF10-1	10.0	1.0
RF10-1.3	10.0	1.3
RF-1016	10.0	1.6
RF-1018	10.0	1.8
RF10-2	10.0	2.0
RF10-3	10.0	3.0
RF10.5-1	10.5	1.0
RF10.5-15	10.5	1.5
RF10.5-2	10.5	2.0
RF-11632	11.6	3.2
RF12-1.5	12.0	1.5
RF-1210	12.0	1.0
RF12-2.7	12.0	2.7
RF-1220	12.0	2.0
RF12-3	12.0	3.0
RF12-3.6	12.0	3.6
RF-1232	12.0	3.2
RF-12520	12.5	2.0
RF12.5-1	12.5	1.0

Part No.	A	B
RF12732	12.7	3.2
RF13-1	13.0	1.0
RF13-3	13.0	3.0
RF14-4	14.0	4.0
RF14530	14.5	3.0
RF14.5-4	14.5	4.0
RF-1463	14.6	3.0
RF-1510	15.0	1.0
RF-1520	15.0	2.0
RF-1530	15.0	3.0
RF16.5-3	16.5	3.0
RF18-1.3	18.0	1.3
RF18-1.5	18.0	1.5
RF18-2.5	18.0	2.5
RF19-1	19.0	1.0
RF19-2	19.0	2.0
RF19-3	19.0	3.0
RF19-4	19.0	4.0
RF-19823	19.8	2.3
RF20-1	20.0	1.0
RF20-1.5	20.0	1.5
RF20-1.8	20.0	1.8
RF-2023	20.0	2.3
RF-2025	20.0	2.5
RF-2030	20.0	3.0
RF22-2	22.0	2.0
RF22-2.5	22.0	2.5
RF22.1-10.4	21.7	10.4
RF24.6-3	24.6	3.0
RF25-2.3	25.0	2.3
RF27-3	27.0	3.0
RF28-3.2	28.0	3.2
RF30-2	30.0	2.0
RF40-1	40.0	1.0
RF58-1.5	58.0	1.5
RF58-2	58.0	2.0
RF64.7-2.5S	64.7	2.5

橡膠腳墊 RUBBER FOOT

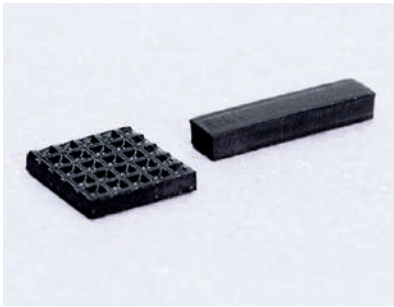

- Material: Rubber/Silicon Rubber
- Color: Black
- Unit: mm
- Other Materials Available: EPDM, Poron
- Optional Thickness: 0.5-10mm

用途：背膠式，可快速將腳墊固定於機殼，黏性佳、不脫落。

可依客戶指定長、寬、高裁切成各種形狀，如方形、圓形。表面可分為平面、斜紋等。

Different size available per request.

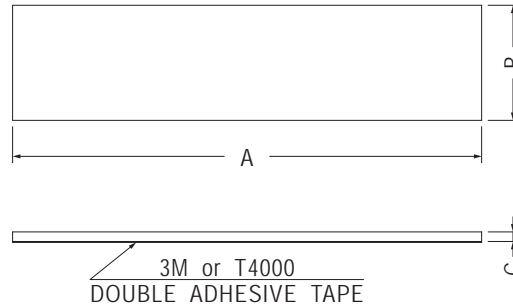

Part No.	A	B	C
SF050435	5.0	4.5	3.5
SF062313	6.0	2.3	1.3
SF060425	6.0	4.0	2.5
SF652840	6.5	2.8	4.0
SF652850	6.5	2.8	5.0
SF070215	7.0	2.0	1.5
SF070216	7.0	2.0	1.6
SF070304	7.0	3.0	0.4
SF073512	7.0	3.5	1.2
SF070420	7.0	4.0	2.0
SF070620	7.0	6.0	2.0
SF080625	8.0	6.0	2.5
SF852530	8.5	2.5	3.0
SF853520	8.5	3.5	2.0
SF853525	8.5	3.5	2.5
SF80452	8.0	4.5	2.0
SF090855	9.6	8.0	5.5
SF100616	9.9	6.0	1.6
SF100119	10.0	1.9	1.9
SF103512	10.0	3.5	1.2
SF100409	10.0	4.0	0.9
SF100510	10.0	5.0	1.0
SF100520	10.0	5.0	2.0
SF100712	10.0	7.0	1.2
SF100825	10.0	8.0	2.5
SF100850	10.0	8.0	5.0
SF100730	10.5	7.2	3.0
SF110830	11.5	8.0	3.0
SF118781	11.8	7.8	1.0
SF120565	12.0	5.0	6.5
SF120810	12.0	8.5	1.0
SF129515	12.0	9.5	1.5
SF121530	12.0	15.0	3.0
SF1256535	12.5	6.5	3.5
SF1251008	12.5	10.0	0.8
SF-1251015	12.5	10.0	1.5
SF130620	13.0	6.0	2.0
SF130630	13.0	6.0	3.0
SF130735	13.0	7.0	3.5
SF130740	13.0	7.0	4.0
SF130855	13.5	8.0	5.5
SF132525	13.0	2.5	2.5

Part No.	A	B	C
SF140430	14.0	4.0	3.0
SF140440	14.0	4.0	4.0
SF150320	15.0	3.2	2.0
SF150610	15.0	6.0	1.0
SF151016	15.0	10.0	1.6
SF151930	15.0	1.9	3.0
SF152530	15.0	25.0	3.0
SF155030	15.0	50.0	3.0
SF1585601	15.8	5.6	1.0
SF151025	15.8	10.0	2.5
SF-163530	16.0	3.5	3.0
SF160536	16.0	5.0	3.6
SF170525	17.0	5.0	2.5
SF1724330	17.2	4.3	3.0
SF180930	18.0	9.0	3.0
SF181010	18.0	10.0	1.0
SF181020	18.0	10.0	2.0
SF195640	19.0	5.6	4.0
SF195720	19.0	5.7	2.0
SF-197774	19.7	7.7	4.0
SF197760	19.7	7.7	6.0
SF190814	19.7	8.0	1.4
SF190815	19.7	8.0	1.5
SF-1979723	19.7	9.7	2.3
SF1979725	19.7	9.7	2.5
SF-1979730	19.7	9.7	3.0
SF-1972015	19.7	20.0	1.5
SF202515	20.0	2.5	1.5
SF200410	20.0	4.0	1.0
SF200420	20.0	4.0	2.0
SF200510	20.0	5.0	1.0
SF200515	20.0	5.0	1.5
SF200563	20.0	5.0	6.3
SF200568	20.0	5.0	6.8
SF200725	20.0	7.0	2.5
SF201010	20.0	10.0	1.0
SF201015	20.0	10.0	1.5
SF201020	20.0	10.0	2.0
SF201035	20.0	10.0	3.5
SF201056	20.0	10.0	5.6
SF201465	20.0	14.0	6.5
SF201515	20.0	15.0	1.5

Part No.	A	B	C
SF200612	20.5	6.0	1.2
SF210804	21.5	8.6	0.4
SF-221615	22.0	16.0	1.5
SF227640	22.6	7.6	4.0
SF237640	23.0	7.6	4.0
SF230610	23.7	6.5	1.0
SF246011	24.8	6.0	1.1
SF250535	25.0	5.0	3.5
SF250550	25.0	5.0	5.0
SF250760	25.0	7.0	6.0
SF250810	25.0	8.0	1.0
SF250815	25.0	8.0	1.5
SF250820	25.0	8.0	2.0
SF251235	25.0	12.0	3.5
SF251224	25.4	12.7	2.4
SF251232	25.4	12.7	3.2
SF260510	26.8	5.5	1.0
SF270830	27.0	8.0	3.0
SF271810	27.0	18.0	1.0
SF271820	27.0	18.0	2.0
SF27183	27.0	18.0	3.0
SF279032	27.5	9.0	3.2
SF-3064	30.0	6.0	4.0
SF303555	30.0	3.5	5.5
SF-30709	30.0	7.0	0.9
SF3038	30.0	8.0	3.8
SF-301120	30.0	11.0	2.0
SF-301140	30.0	11.0	4.0
SF301230	30.0	12.0	3.0
SF301250	30.0	12.0	5.0
SF301525	30.0	15.0	2.5
SF302055	30.0	20.0	5.5
SF302501	30.0	25.0	1.0
SF30511	30.5	11.0	7.0
SF311510	31.5	15.5	1.0
SF311515	31.5	15.5	1.5
SF3267225	32.0	6.7	2.25
SF321720	32.0	17.0	2.0
SF321725	32.0	17.0	2.5
SF332055	33.0	20.0	5.5
SF332385	33.3	23.3	8.5
SF331125	33.5	11.5	2.5

橡膠腳墊 RUBBER FOOT

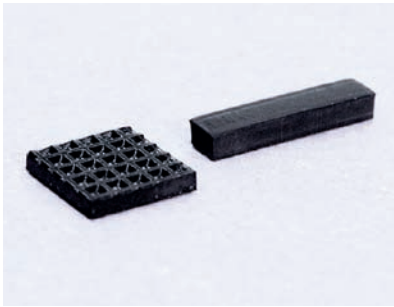

- Material: Rubber/Silicon Rubber
- Color: Black
- Unit: mm
- Other Materials Available: EPDM, Poron
- Optional Thickness: 0.5-10mm

用途：背膠式，可快速將腳墊固定於機殼，黏性佳、不脫落。

可依客戶指定長、寬、高裁切成各種形狀，如方形、圓形。表面可分為平面、斜紋等。

Different size available per request.

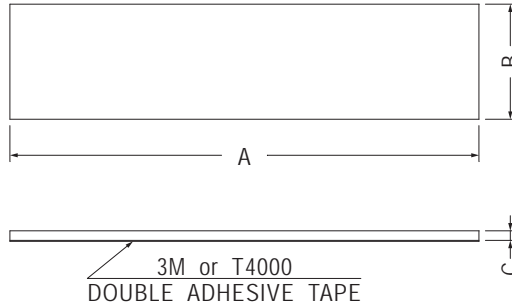

Part No.	A	B	C
SF340220	34.0	2.0	2.0
SF340904	34.6	9.5	0.4
SF-340901	34.7	9.7	1.0
SF351001	35.0	10.0	1.0
SF351580	35.0	15.0	8.0
SF352508	35.0	25.0	0.8
SF361810	36.0	18.0	1.0
SF361820	36.0	18.0	2.0
SF400509	39.5	5.0	0.9
SF-4009	40.0	9.0	1.5
SF400924	40.0	9.0	2.4
SF400930	40.0	9.0	3.0
SF401040	40.0	10.5	4.0
SF401235	40.0	12.0	3.5
SF401240	40.0	12.0	4.0
SF401250	40.0	12.0	5.0
SF401715	40.0	17.5	1.5
SF442010	44.5	20.0	10.0
SF451020	45.0	10.0	2.0
SF473530	47.5	3.5	3.0
SF481040	48.0	10.0	4.0
SF484410	48.0	44.0	1.0
SF491210	49.0	12.0	1.0
SF500620	50.0	6.0	2.0
SF501038	50.0	10.0	3.8
SF541010	54.0	10.0	1.0
SF550515	55.0	5.0	1.5

Part No.	A	B	C
SF582508	58.0	25.0	0.8
SF582514	58.0	25.0	1.4
SF582516	58.0	25.0	1.6
SF600610	60.0	6.0	1.0
SF600613	60.0	6.0	1.3
SF600625	60.0	6.0	2.5
SF-6064	60.0	6.0	4.0
SF600907	60.0	9.0	0.7
SF601010	60.0	10.0	1.0
SF601025	60.0	10.0	2.5
SF6017530	60.0	17.5	3.0
SF602010	60.0	20.0	10.0
SF606767	60.0	6.7	6.7
SF652020	65.0	20.0	2.0
SF654030	65.0	40.0	3.0
SF700525	70.0	5.0	2.5
SF701820	70.0	18.0	2.0
SF702010	70.0	20.0	1.0
SF764005	76.0	40.0	0.5
SF-801004	80.0	10.0	0.5
SF845208	84.6	52.6	0.8
SF880810	88.0	8.0	1.0
SF951232	95.0	12.0	3.2
SF980830	98.0	8.0	3.0
SF993555	99.0	3.5	5.5
SF990915	99.0	9.9	1.5
LSF-002	100.0	12.0	3.5

Part No.	A	B	C
SF107581	107.0	58.0	1.5
SF1100540	110.0	5.6	4.0
SF1101010	110.0	10.0	1.0
SF1111009	111.0	10.0	0.9
SF1200310	120.0	3.0	1.0
SF1254620	125.0	46.0	2.0
SF1302030	130.0	20.0	3.0
SF1302020	130.0	20.0	2.0
SF1340220	134.0	2.0	2.0
SF1400520	140.0	5.0	2.0
SF140101	140.0	10.0	1.0
SF140251	140.0	25.0	1.0
SF14510520	145.0	105.0	2.0
SF1461010	146.0	10.0	1.0
SF1500712	150.0	7.0	1.2
SF-1501004	150.0	10.0	0.5
SF1501515	150.0	15.0	1.5
SF1600610	160.0	6.0	1.0
SF1664930	166.5	49.0	3.0
SF2500515	250.0	5.0	1.5
SF2506520	250.0	65.0	2.0
SF2701655	270.0	165.0	0.5
SF2581420	258.0	14.5	2.0
SF3101150	310.0	11.6	5.0
SF3101250	310.0	12.0	5.0
SF5400208	540.0	2.9	0.8

橡膠腳墊 RUBBER FOOT

用途：背膠式，可快速將腳墊固定於機殼，黏性佳、不脫落。

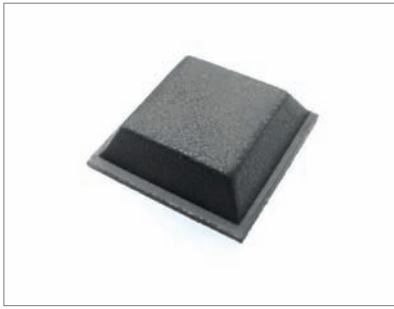

- Material: Rubber/Silicon Rubber/PU
- Color: Black
- Unit: mm

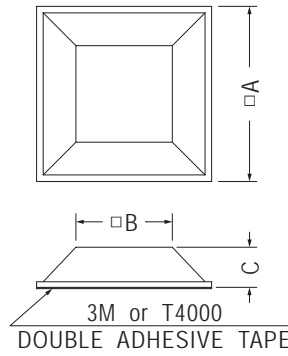

Part No.	A	B	C
SF-004	12.7	9.0	3.5
SF-005	12.7	7.0	6.0
SF-006	20.0	14.0	7.6
SF-007	10.5	8.6	2.5
SF-009	12.5	9.5	4.0
SF-016	12.7	9.8	3.0
SF-017	12.5	9.7	3.5



- Material: Rubber/Silicon Rubber
- Color: Black
- Unit: mm
- Other Materials Available: EPDM, Poron...
- Optional Thickness: 0.7-5.0mm

用途：背膠式，可快速將腳墊固定於機殼，黏性佳、不脫落。

可依客戶指定長、寬、高裁切成各種形狀，如方形、圓形。表面可分為平面、斜紋等。

Different size available per request.

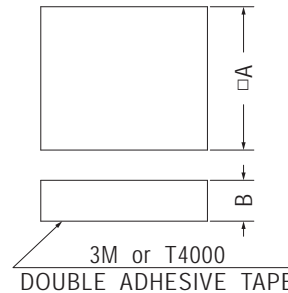

Part No.	A	B
SF050510	5.0	1.0
SF050512	5.0	1.2
SF-6610	6.0	1.0
SF-6615	6.0	1.5
SF060625	6.0	2.5
SF-664	6.0	4.0
SF-665	6.0	5.0
SF060660	6.0	6.0
SF-001	6.4	3.0
SF070715	7.0	1.5
SF070720	7.0	2.0
SF070740	7.0	4.0
SF070755	7.0	5.5
SF070780	7.0	8.0
SF73732	7.3	2.0
SF-080801	8.0	1.0
SF-080802	8.0	2.0
SF080823	8.0	2.3
SF-0808025	8.0	2.5
SF090945	9.0	4.5
SF-002	9.7	2.0

Part No.	A	B
SF-979735	9.7	3.5
SF101007	10.0	0.7
SF101009	10.0	0.9
SF101010	10.0	1.0
SF101016	10.0	1.6
SF101020	10.0	2.0
SF101023	10.0	2.3
SF101025	10.0	2.5
SF101030	10.0	3.0
SF101035	10.0	3.5
SF101040	10.0	4.0
SF101050	10.0	5.0
SF101060	10.0	6.0
SF111160	11.0	6.0
SF11511550	11.5	5.0
SF11511565	11.5	6.5
SF-121212	12.0	1.2
SF121225	12.0	2.5
SF-003	12.0	5.0
SF121255	12.0	5.5

Part No.	A	B
SF121270	12.0	7.0
SF-1272	12.7	2.3
SF-131320	13.0	2.0
SF14142	14.0	2.0
SF141480	14.0	8.0
SF151512	15.0	1.2
SF-151515	15.0	1.5
SF151535	15.0	3.5
SF151550	15.0	5.0
SF161610	16.0	1.0
SF171725	17.0	2.5
SF181810	18.0	1.0
SF181820	18.0	2.0
SF181840	18.0	4.0
SF181850	18.0	5.0
SF202030	20.0	3.0
SF25425450	25.4	5.0
SF404010	40.0	1.0
SF404050	40.0	5.0
SF505050	50.0	5.0

橡膠腳墊 RUBBER FOOT



- Material: Rubber/Silicon Rubber
- Color: Black
- Unit: mm
- Other Materials Available: EPDM

用途：背膠式，可快速將腳墊固定於機殼，黏性佳、不脫落。

尺寸可依客戶要求。
Different size available per request.

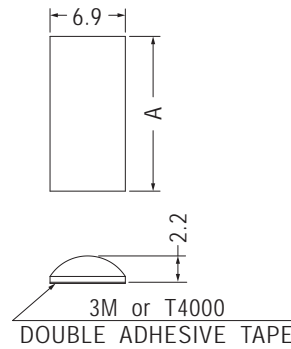

Part No.	A
SF14722	14.0
SF28722	27.8



- Material: Rubber
- Color: Black
- Unit: mm

用途：背膠式，可快速將腳墊固定於機殼，黏性佳、不脫落。

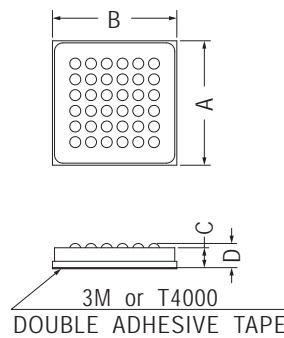

Part No.	A	B	C	D
P004	14.0	13.5	2.1	2.6
P005	15.0	14.5	2.6	3.1

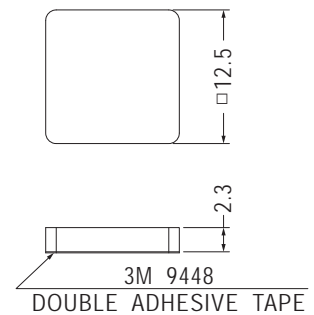
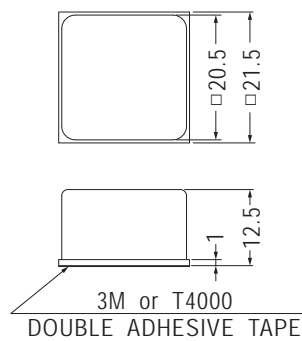

- Color: Computer

Part No.	Package
SF202013	1000

Part No.	Package
TF-1698	1000

橡膠腳墊 RUBBER FOOT

用途：背膠式，可快速將腳墊固定於機殼，黏性佳、不脫落。



- Material: Rubber/Silicon Rubber
- Color: Black
- Unit: mm
- Other Materials Available: EPDM

尺寸可依客戶要求。
Different size available per request.

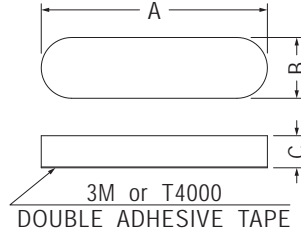

Part No.	A	B	C
PT080210	8.0	2.0	1.0
PT100612	10.5	6.0	1.2
PT100614	10.5	6.0	1.4
TF-1627	15.2	9.2	3.0
PT158932S	15.8	9.3	2.0
PT160915	16.0	9.5	1.5
PT-1762	17.5	6.5	2.0
PT200612	20.5	6.2	1.2
PT200617	20.5	6.2	1.7
PT2492	24.0	9.0	2.0
PT270720	26.8	7.2	2.0
PT005	26.8	7.2	3.8
PT360712	36.0	7.0	1.2
PT690920	69.6	9.8	2.0



- Material: Rubber
- Color: Black
- Unit: mm

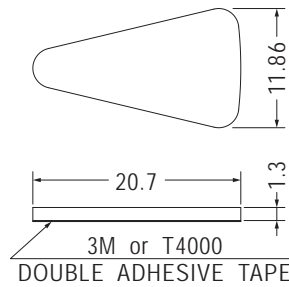

Part No.	Package
TF201113	1000

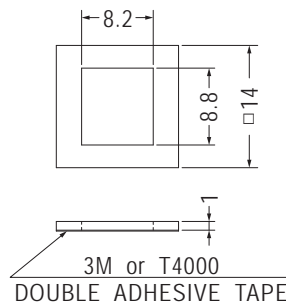

Part No.
SF141410



- Material: Silicon Rubber
- Color: Black
- Unit: mm

用途：背膠式，可貼於D-SUB連接器之外觀或裡面保護或絕緣。

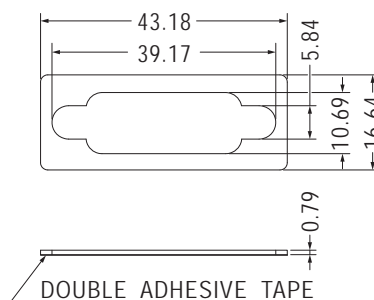

Part No.	Package
TF-1596	1000

EVA泡棉 EVA FOAM

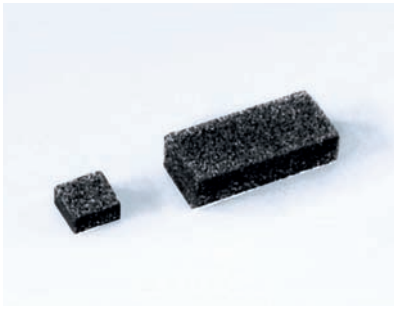

- Material: EVA
- Color: Black
- Unit: mm

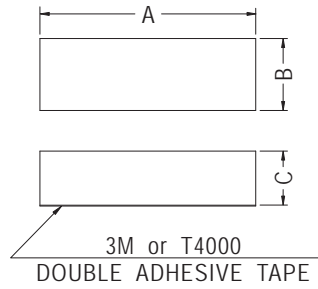

用途：腳墊，零件之絕緣，可用背膠（單面或雙面）。

尺寸可依客戶要求。
Different size available per request.

Part No.	A	B	C
EVA862	8.0	6.0	2.0
EVA120430	12.0	4.0	3.0

功率晶體導熱矽膠片 TRANSISTOR THERMAL CONDUCTIVE PAD

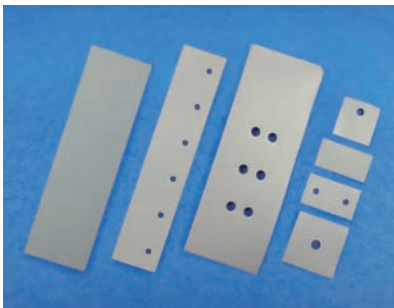

- Material: Silicon (UL)
- Flame Class: 94V-0
- Color: Gray
- Unit: mm

用途：用於功率晶體之導熱和絕緣。

可依客戶指定長、寬、高裁切成各種形狀，如方形、圓形。

Different size available per request.

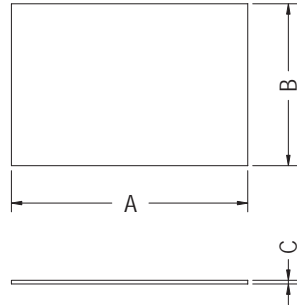

Part No.	A	B	C	Package
SI1913	19.0	13.0	0.3	1000
SI21125	21.0	12.5	0.3	
SI2519	25.0	19.0	0.3	
SI3012	30.0	12.0	0.3	
SI3030-1	30.0	30.0	0.3	
SI4520	45.0	20.5	0.3	
SI304802	48.0	30.0	0.23	100
SI300200	300.0	200.0	0.3	

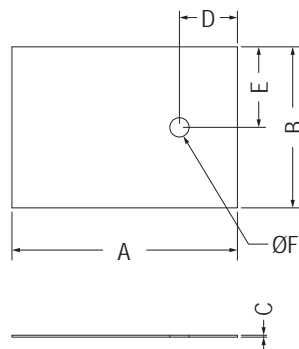

Part No.	A	B	C	D	E	F	Package
SI3023	30.0	23.0	0.3	15.0	12.6	3.0	1000
SI3030	30.0	30.0	0.45	15.0	15.0	4.5	
SI2535	35.0	25.0	0.3	9.0	12.5	3.0	

用途：用於功率晶體之導熱和絕緣。

- Material: Silicon (UL)
- Flame Class: 94V-0
- Color: Gray
- Unit: mm

可依客戶指定長、寬、高裁切成各種形狀，如方形、圓形。

Different size available per request.

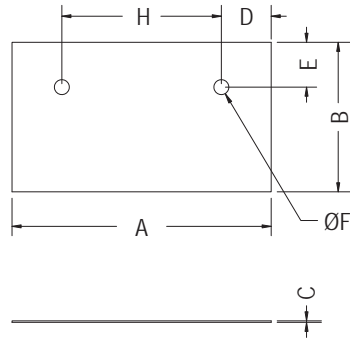
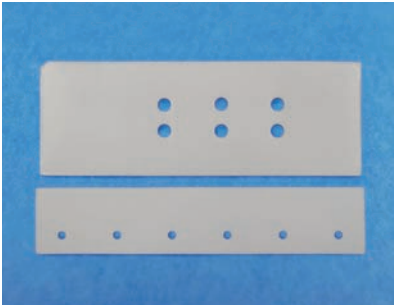
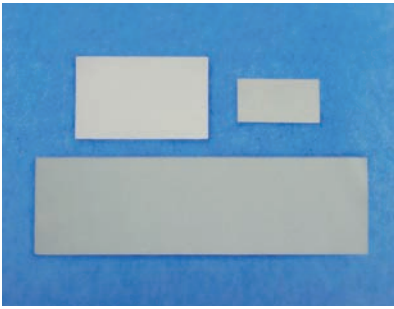

Part No.	A	B	C	D	E	F	H	Package
SI30172H	30.5	17.8	0.3	6.4	8.9	3.1	17.7	1000
SI335125H2	33.5	12.5	0.3	5.75	7.0	3.0	22.0	
SI34132H	34.0	13.0	0.3	5.0	6.5	5.8	24.0	
SI5230	52.0	30.0	0.3	10.0	9.0	3.0	32.0	
SI752845	75.0	28.0	0.45	27.0	7.5	3.2	21.0	

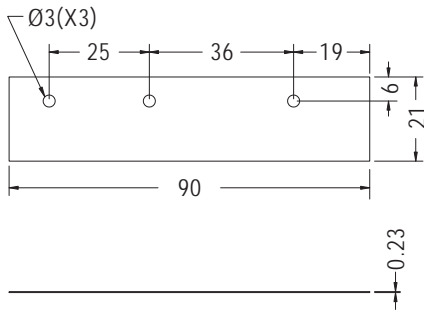

Part No.	Package
SI9021	500

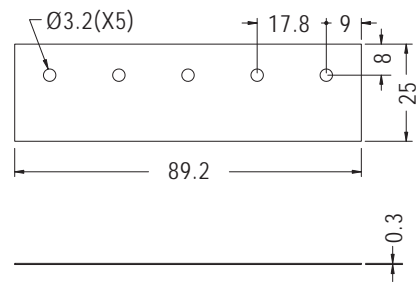

Part No.	Package
SI8925H5	500

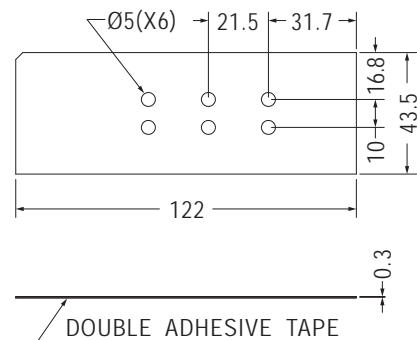

Part No.	Package
SI12243H6A	1000

導電泡棉 CONDUCTIVE FOAM

- Material: EMI Conductive Fabric
- Unit: mm

用途：EMI屏蔽導電，可用背膠(單面或雙面)，尺寸可依客戶要求。
Different size available per request.



Part No.	Package
CRGI01	1000



Part No.	Package
CRGH06	1000



Part No.	Package
CRGP11	1000

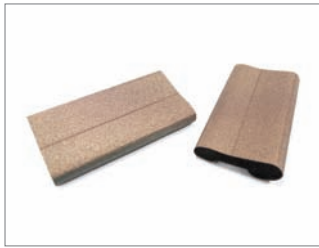

Part No.	Package
CRGF02	1000

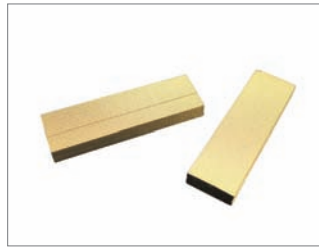

Part No.	Package
CRGR-G07	1000



Part No.	Package
CRGI12	1000



Part No.	Package
CRGS03	1000



Part No.	Package
CRGR08	1000



Part No.	Package
CRGT13	1000



Part No.	Package
CRGR04	1000



Part No.	Package
CRGC09	1000



Part No.	Package
CRGD14	1000



Part No.	Package
CRGI-E05	1000



Part No.	Package
CRGL10	1000



Part No.	Package
CRGI-W15	1000

10

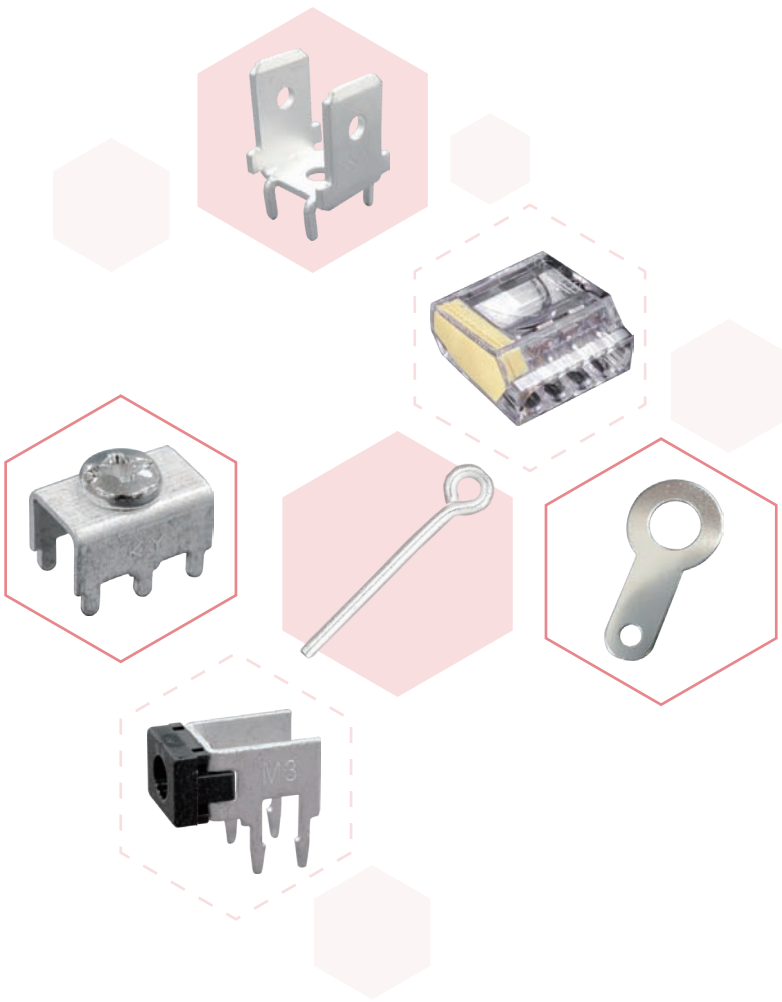

- 阻尼齒輪
Damper Gears
- PC板焊接端子
PCB Terminals
- 測試針/測試點
Test Pins
- 保險絲座/測試座
Fuse & Test Holders
- 彈片/電晶體夾
Clamps & Clips
- 接地片
Ground Terminals
- 端子台
Terminal Blocks
- 接線夾/跳線
Quick Splices &
Jumper Wires
- 功率晶體壓板
Transistor Clamps



插式電線連接頭 PUSH-IN WIRE CONNECTOR

用途：用於單芯電源線之連接，插入式，免用膠帶，方便，省時。

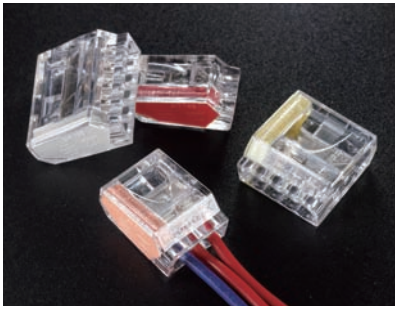

- Material: PC (UL) 94V-0
- Unit: mm



NOTE:

安培(Current): 24A(VDE)

伏特(Voltage): 600V

使用溫度(Working temp): 110°C

使用線徑範圍(Wire Range): #12-22 AWG Solid conductor

撥線長度(Stripping Length): 11mm(0.43 inch)

顏色(Color): 以顏色區分,易於辨別使用電線數目

(The colors are used to define the numbers of connector poles.)

安全認證通過(Safety Certification):

美國USA(UL),德國Germany(VDE),芬蘭Finland(Finko),歐洲Europe(CE)

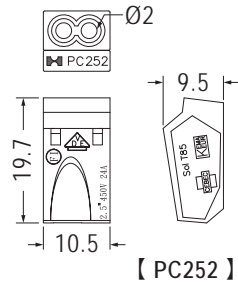

【 PC252 】

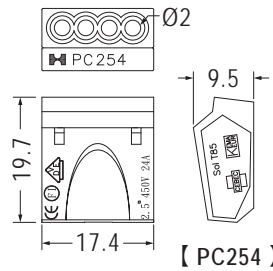

【 PC254 】

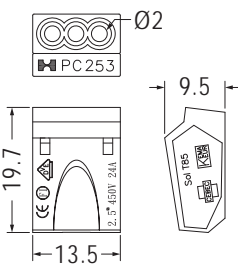

【 PC253 】

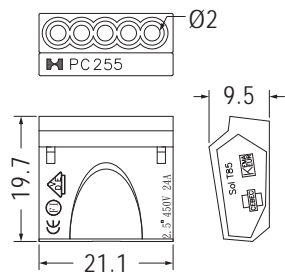

【 PC255 】

Part No.	Color	Poles	Package
PC252	Red	2	500
PC253	Orange	3	
PC254	Yellow	4	
PC255	Gray	5	

快速接線夾 QUICK SPLICE

用途：用於中途輔助接線，且使用時不需剝線，將電線放好位置壓入銅片即可，省時美觀。

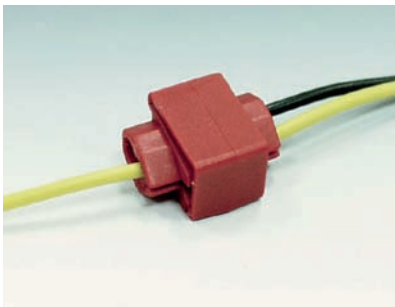

- Housing Material: PP
- Metal Material: Copper
- Finish: Tin Plated
- Unit: mm

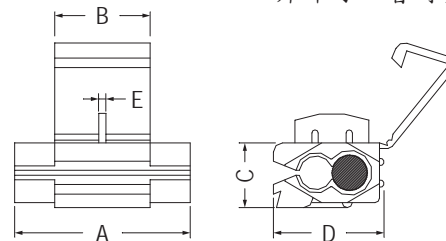

Part No.	Wire Range AWG	A	B	C	D	E	Color	Package
3MR	22-18	19.5	10.6	8.2	13.5	0.8	Red	500
3MB	18-14	19.5	10.6	8.2	13.5	0.8	Blue	
3MY	12-10	20.0	20.0	11.1	15.0	0.9	Yellow	200

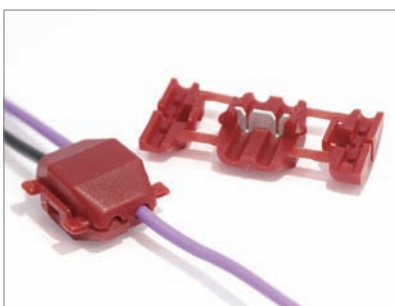

- Insulation Material: Nylon
- Insulation Color: Red
- Terminal Material: Brass
- Wire Range: #20-18 AWG(0.5-0.75mm)
- Terminal Thickness: 0.8mm
- Plating: Tin Plated
- Unit: mm

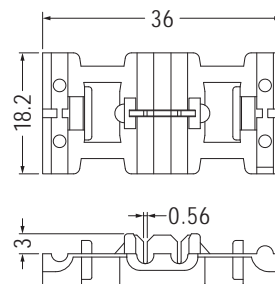

Part No.	Package
878008	250

端子台 TERMINAL BLOCK

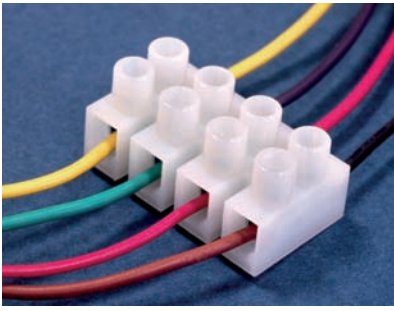

- Housing Material: Nylon 66 UL94V-2
- Pole: 1~12 Poles
- Working Temperature: 105°C
- PA7DS, PA9DS: With Wire Protector
- Safety Certification: UL、CSA、VDE、F、D、N、S...。
- Color: Natural



- H=底部加高(Raised Base)
- DS=加彈片(Wire Protector)
- F=平底型(Flat Base Type)

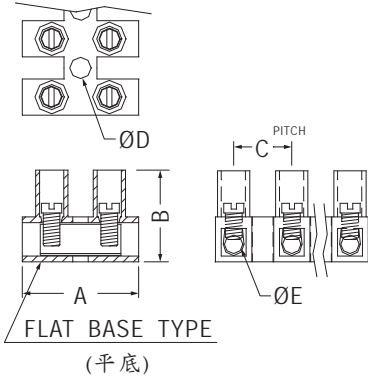
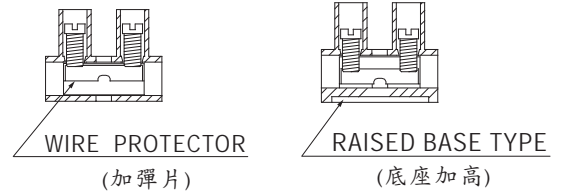

Part No.	線徑 mm ²	安培 Amp	電壓 Volt	螺絲 Screw	A	B	C	D	E	Poles
PA7-12	1.5	17.5	450V	M2.6X5P	17.0	14.5	8.2	2.9	2.8	12
PA7-12DS	1.5	17.5	450V	M2.6X5P	17.0	14.5	8.2	2.9	2.8	
PA7F-12	1.5	17.5	450V	M2.6X5P	17.0	13.5	8.2	2.9	2.8	
PA7F-12DS	1.5	17.5	450V	M2.6X5P	17.0	13.5	8.2	2.9	2.8	
PA9-12	2.5	24.0	450V	M3.0X6P	20.2	16.7	10.0	3.6	3.2	
PA9-12DS	2.5	24.0	450V	M3.0X6P	20.2	16.7	10.0	3.6	3.2	
PA9F-12	2.5	24.0	450V	M3.0X6P	20.2	16.2	10.0	3.6	3.2	

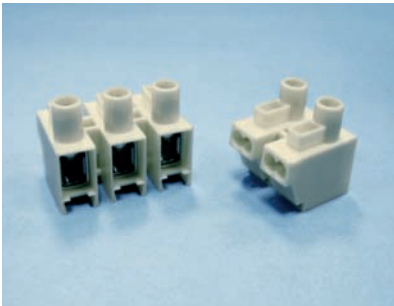

- Housing Material: Nylon 66 (UL) 94V-2
- Working Temperature: 105°C
- Color: Natural
- Unit: mm

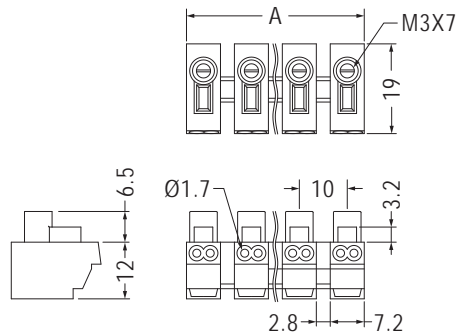

Part No.	A
PA11-2P	17.3
PA11-3P	27.5

按壓式端子台 PUSH-BUTTON TERMINAL BLOCK

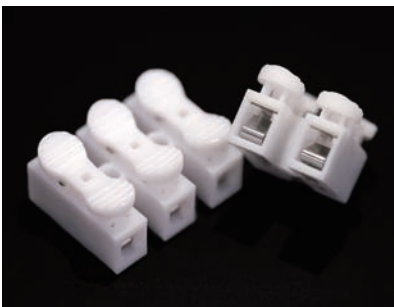

- Material: PP
- Working Temperature: 85°C
- Color: White
- Unit: mm

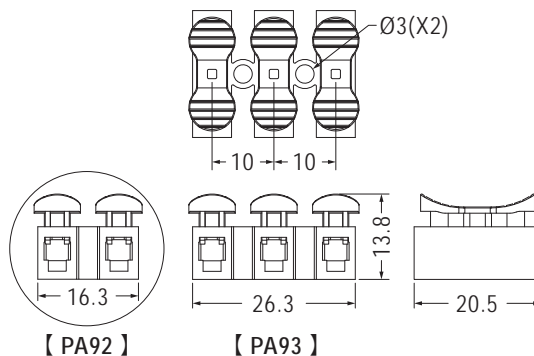

Part No.	線徑 mm ²	安培 Amp	電壓 Volt
PA92	0.5~2.5	10.0	250V
PA93	0.5~2.5	10.0	250V

端子座 TERMINAL BLOCK

用途：用於大電流機器接線。

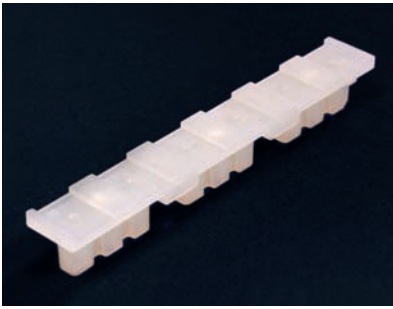

- Material: PC (UL)
- Flame Class: 94V-2/94V-0
- Color: Natural
- Unit: mm

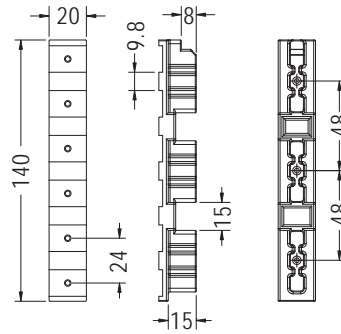

Part No.	Package
TERBL-6	50

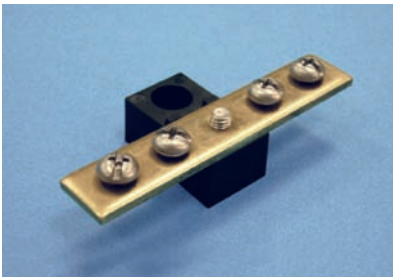

- Material: PBT (UL)
- Flame Class: 94V-0
- Color: Black
- Unit: mm

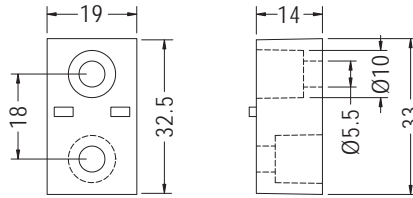

Part No.	Package
TERBL-33	200

彈簧螺紋端子 SCREW-ON CONNECTOR

用途：連接電線，內附彈簧，旋轉時彈簧則夾緊電線不易脫落。



- Material: PP
- Color: Orange
- Unit: mm
- Wire Spring Insert

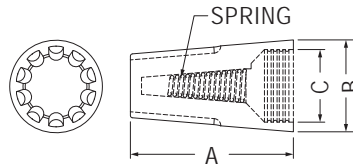

Part No.	Wire Size Range		A	B	C	Package
	Max.	Min.				
P1	#18X2	#24X2	15.2	8.6	6.5	1000
P2	#16X3	#20X3	17.7	9.9	7.1	
P3	#14X3	#18X3	22.0	12.4	9.8	
P4	#14X3	#16X3	24.6	14.0	11.0	

- Material: PBT (UL) 94V-0
- Color: Black
- Unit: mm
- Wire Spring Insert

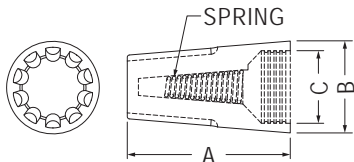

Part No.	A	B	螺紋 內徑 C	適用電線範圍 Suitable Wires AWG	Package
P1B	15.2	8.6	6.5	22-18	1000
P3B	21.8	12.7	9.6	22-14	500

閉端端子 CLOSE END CONNECTOR

用途：電線剝去外皮插入端子內，用工具壓著即可，接觸良好不脫落。

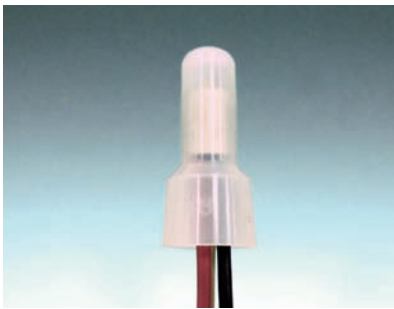

- Housing Material: Nylon 66 (UL) 94V-2
- Metal Material: Aluminum
- Color: Natural
- Unit: mm

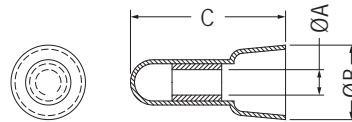

Part No.	Wire Range	A	B	C	Package
CE1	#22-18	2.6	7.8	18.0	1000
CE2	#22-14	3.1	9.5	20.0	
CE5	#22-10	4.4	12.5	25.2	

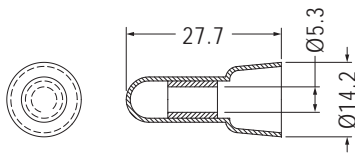

- Metal Material: Tin Plated Copper

Part No.	Wire Range	Package
CE8	#16-10	500

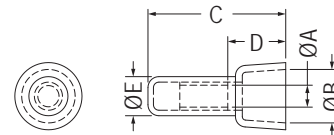

- Metal Material: Copper

Part No.	Wire Range	A	B	C	D	E	Package
C3	#22-16 1.25 mm ²	2.7	6.5	18.0	7.7	5.1	1000
C4	#16-14 2 mm ²	3.3	7.9	20.2	8.5	5.6	
C5	#12-10 5.5 mm ²	4.3	10.5	24.7	11.6	7.2	
C8	#8 8 mm ²	5.3	12.2	27.3	13.0	9.2	500

防水接線帽 WATERPROOF WIRE CONNECTORS

用途：通過UL486D認證，防水標準IP55等級適用於潮濕掩埋，可防水、防塵、防腐。可快速接線，剝線13-16mm線芯插入接線帽底部後，鎖緊即可。0.82-21mm²單芯、絞線、花線皆可使用。



- Material: Tough thermoplastic (PP)
- Spring Insert: Steel
- Color: Blue/Red/Black
- Unit: mm
- 耐壓(Voltage): 600V
- 使用溫度(Working temp): 105°C

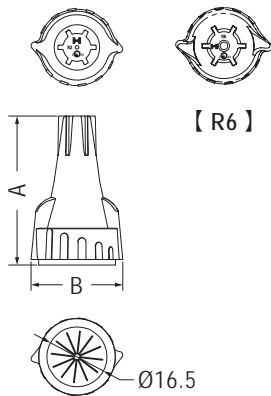

Part No.	Wire Range		A	B	Package
	Max.	Min.			
R3	3#12	2#20	40.9	25.2	100
R6	4#10	3#16	47.2	26.5	

電線固定夾片 WIRE CLAMP

用途：使用於電子、電腦產品內部電線之固定，可彎曲打開重覆使用，維修方便。



- Metal Material: Steel
- Plastic Material: PVC Tube (UL)
- Color: Black
- Unit: mm

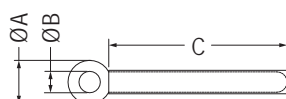

Part No.	A	B	C	Package
WL3-32T	7.5	3.3	32.0	1000
WL3-52T	7.5	3.3	52.0	
WL3-60T	8.0	3.6	62.0	
WL4-35T	8.5	4.2	35.0	
WL4-50T	8.0	4.1	52.0	
WL4-70T	7.5	4.2	74.5	
WL4-78T	8.0	4.1	78.5	500
WL5-70T	8.4	5.1	60.0	
WL6-78T	10.0	6.0	78.0	

電線固定夾片 WIRE CLAMP

用途：使用於電子、電腦產品內部電線之固定，可彎曲打開重覆使用，維修方便。



- Metal Material: Steel
- Plastic Material: Polyolefin (UL)
- Color: Black
- Unit: mm

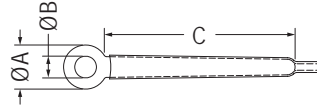

Part No.	A	B	C	Package
WL3-12H	7.5	3.3	12.0	1000
WL3-32H	7.5	3.3	32.0	
WL3-35H	5.6	3.5	29.9	
WL3-52H	7.5	3.2	52.0	
WL3-60H	8.0	3.6	62.0	
WL4-35H	8.5	4.2	35.0	
WL4-50H	8.0	4.1	52.0	
WL4-56H	8.0	4.1	48.2	
WL4-70H	7.5	4.2	74.5	500
WL4-78H	8.0	4.1	78.5	
WL4-90H	7.5	4.2	94.5	
WL5-70H	8.4	5.1	60.0	
WL6-78H	10.0	6.0	78.0	



- Metal Material: Steel
- Plastic Material: PVC Tube (UL)
- Color: Black
- Unit: mm

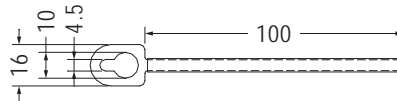

Part No.	Package
WLC-1	500



- Metal Material: Tin Plated Steel
- Plated Material: Polyolefin (UL)/PVC Tube (UL)
- Color: Black
- Unit: mm

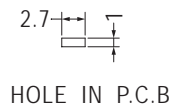
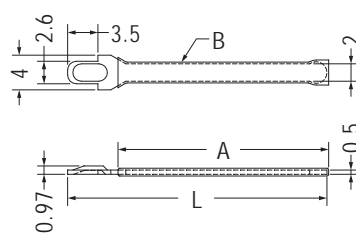

Part No.	A	B	L	Package
WLD-30H	24.0	1.5 Heat Shrinking	30.0	1000
WLD-50H	47.0	1.5 Heat Shrinking	50.0	
WLD-30T	25.0	1.93 PVC Tube	30.0	
WLD-50T	45.0	1.93 PVC Tube	50.0	

測試點 TEST PIN

用途：焊於電子，電腦PC板上重要測試端點，可勾掛探棒，不短路，鍍金接觸良好，不氧化。

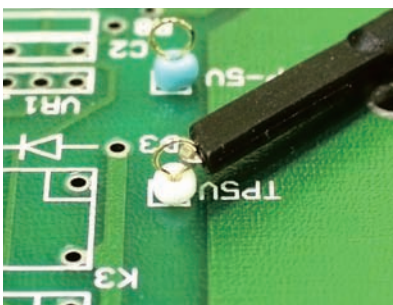

- Material: PBT (UL)
- Flame Class: 94V-0
- Pin Material: Phosphor Bronze
- Pin Finish: Gold Plated
- Unit: mm

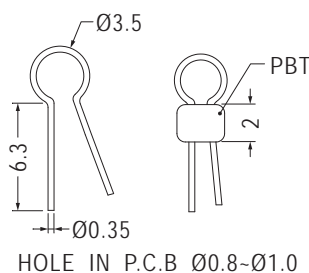

Part No.	Color	Package
TEST-1(R)	Red	1000
TEST-1(GR)	Green	
TEST-1(BU)	Blue	
TEST-1(BK)	Black	
TEST-1(Y)	Yellow	
TEST-1(W)	White	

測試點 TEST PIN

用途：焊於電子，電腦PC板上重要測試端點，可勾掛探棒，不短路，鍍金接觸良好，不氧化。



- Material: PBT (UL)
- Flame Class: 94V-0
- Pin Material: Phosphor Bronze
- Pin Finish: Gold Plated
- Unit: mm

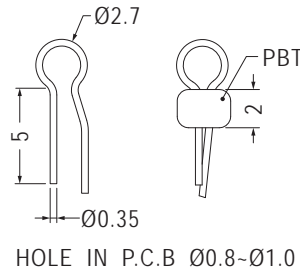

- Color: Black

Part No.	Package
TEST-3S	500

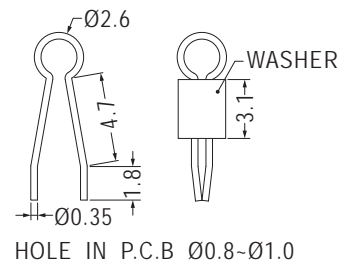
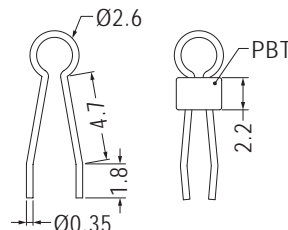
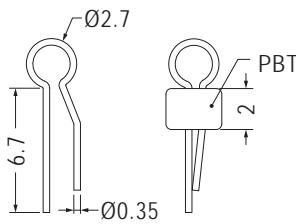

Part No.	Color	Package
TEST-3(R)	Red	1000
TEST-3(GR)	Green	
TEST-3(BU)	Blue	
TEST-3(BK)	Black	
TEST-3(Y)	Yellow	
TEST-3(W)	White	

Part No.	Color	Package
TEST-7(R)	Red	1000
TEST-7(G)	Green	
TEST-7(BU)	Blue	
TEST-7(BK)	Black	
TEST-7(Y)	Yellow	
TEST-7(W)	White	

- Washer Material: Ceramic
- Color: Milk White

Part No.	Package
TEST-7CN	1000



- Material: PBT (UL)
- Flame Class: 94V-0
- Pin Material: Phosphor Bronze
- Pin Finish: Gold Plated
- Unit: mm

用途：焊於電子，電腦PC板上重要測試端點，可勾掛探棒，不短路，鍍金鍍錫接觸良好，不氧化。

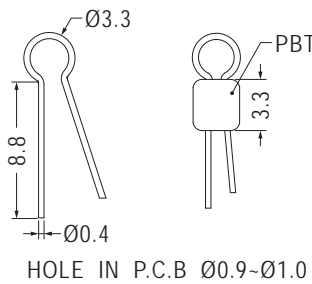

Part No.	Color	Package
TEST-55R	Red	1000
TEST-55GR	Green	
TEST-55BU	Blue	
TEST-55(B)	Black	
TEST-55Y	Yellow	
TEST-55W	White	

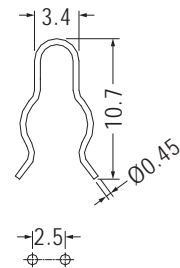
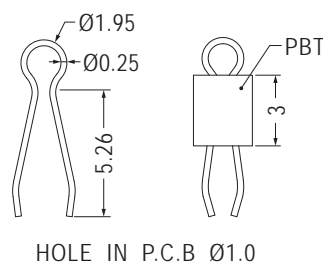
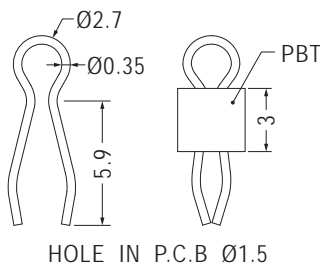

- Pin Finish: Tin Plated

Part No.	Color	Package
TEST-87(R)	Red	1000
TEST-87(GR)	Green	
TEST-87(BU)	Blue	
TEST-87(B)	Black	
TEST-87(Y)	Yellow	
TEST-87	White	

- Color: White

Part No.	Package
TEST-129	1000

Part No.	Package
TEST-2	1000

測試針 TEST PIN

用途：焊於電子，電腦PC板上重要測試端點，鍍金接觸良好，不氧化。

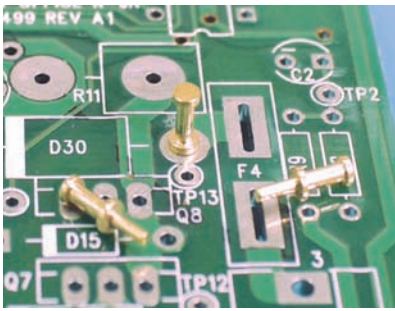

- Material: Gold Plated Brass
- Unit: mm

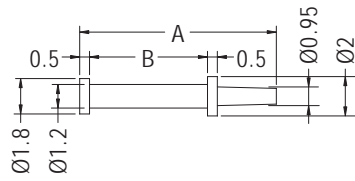

HOLE IN P.C.B Ø0.9-Ø1.0

Part No.	A	B	Package
TEST-4	14.0	10.0	1000
TEST-5	10.0	6.0	2000

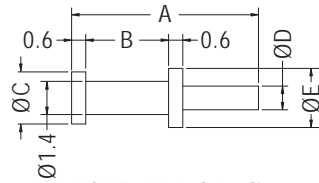

HOLE IN P.C.B Ø1.0

Part No.	A	B	C	D	E	Package
TEST-22	7.9	3.5	2.2	1.0	2.5	2000
TEST-34	8.0	3.8	1.6	0.8	1.6	

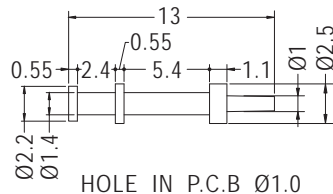

HOLE IN P.C.B Ø1.0

Part No.	Package
TEST-8	2000

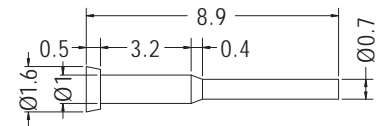

Part No.	Package
TEST-31	2000



- Material: Nickel Plated Brass
- Unit: mm

用途：焊於電子，電腦PC板上重要測試端點，鍍鎳接觸良好，不氧化。

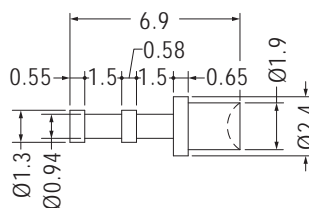

HOLE IN P.C.B Ø2.0

Part No.	Package
TEST-6	2000



- Material: Tin Plated Copper
- Unit: mm

用途：焊於電子，電腦PC板上重要測試端點，接觸良好，不氧化。

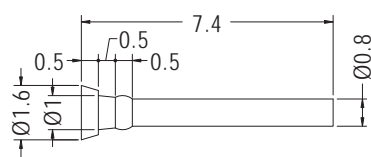

HOLE IN P.C.B Ø0.8-Ø0.9

Part No.	Package
TEST-10	2000

測試針 TEST PIN

用途：焊於電子，電腦PC板上重要測試端點，接觸良好，不氧化。



- Material: Tin Plated Brass
- Unit: mm

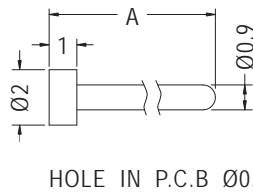

Part No.	A	Package
TEST-24	15.0	2000
TEST-25	6.0	
TEST-26	8.5	
TEST-28	10.0	

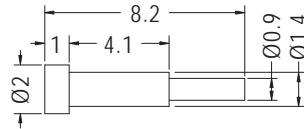

Part No.	Package
TEST-140	1000

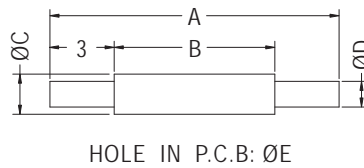

Part No.	A	B	C	D	E	Package
TEST-9	16.0	10.0	1.5	1.0	1.0	2000
TEST-23	18.0	10.0	2.5	1.6	1.7	
TEST-136	19.5	16.5	2.5	1.6	1.7	

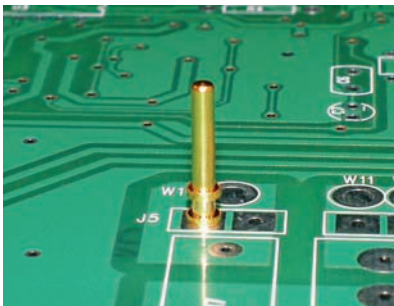

- Material: Gold Plated Brass
- Unit: mm

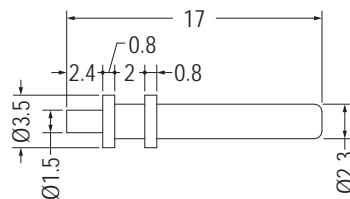

Part No.	Package
TEST-27	2000



- Material: Tin Plated Brass
- Unit: mm

用途：焊於電子，電腦PC板上重要測試端點，可勾掛探棒，不短路，接觸良好，不氧化。

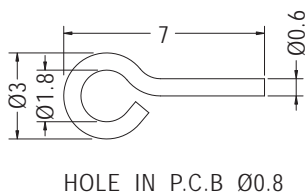

Part No.	Package
TEST-12	2000

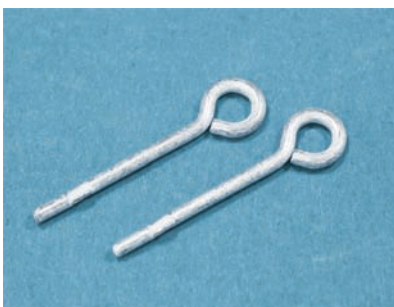

- Material: Tin Plated Copper
- Unit: mm

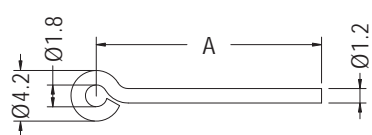

Part No.	A	Package
JUMP-21	18.7	1000
JUMP-34	15.0	

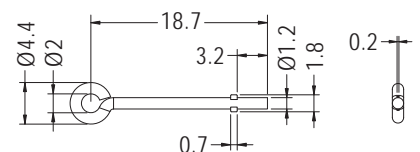

Part No.	Package
JUMP-26	2000

測試點 TEST PIN

用途：配合焊接，做為PC板與PC板之導電與間隔之用或測試端點。

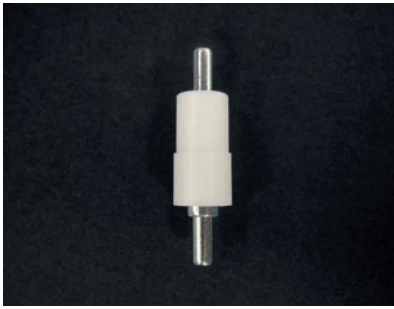

- Material: Nylon 66 (UL)/94V-0
- Pin Material: Brass
- Color: Natural
- Unit: mm

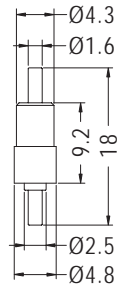

Part No.	Package
ROFF-10F	1000

測試座 TEST HOLDER

用途：做為電路板電氣連接或測試端點。

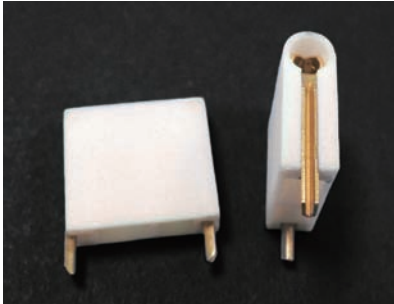

- Material: Nylon 66 (UL)
- Material: Gold Plated Brass
- Flame Class: 94V-0
- Color: Natural
- Unit: mm

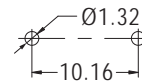
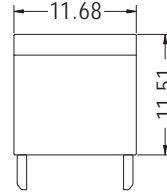
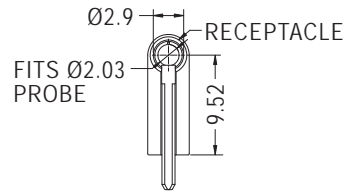

RECOMMENDED MOUNTING HOLE PARTERN

Part No.	Package
TEST-114	1000

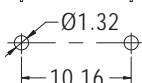
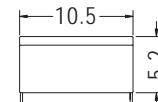
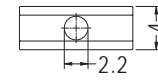
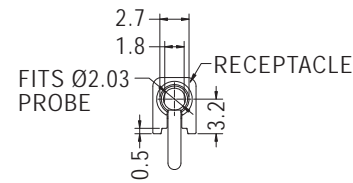
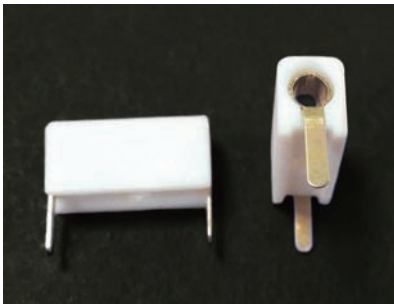

RECOMMENDED MOUNTING HOLE PARTERN

Part No.	Package
TEST-115	1000

跳線 JUMPER WIRE

用途：做為跳線使用。



- Material: Tin Plated Copper
- Plastic Material: Polyolefin (UL)
- Color: Black
- Unit: mm

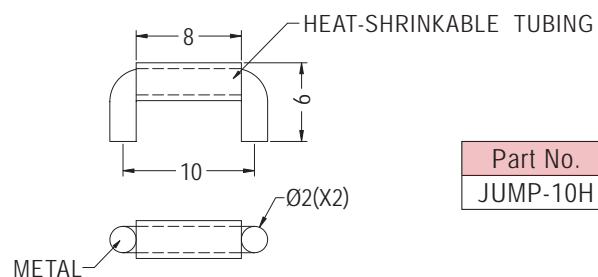

Part No.	Package
JUMP-10H	1000

保險絲座 FUSE HOLDER

用途：用於保險絲之絕緣與間隔。

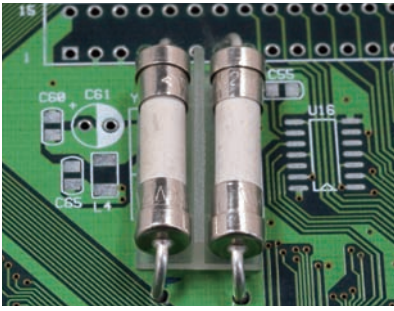

- Material: PC (UL)
- Flame Class: 94V-2/94V-0
- Color: Natural
- Unit: mm

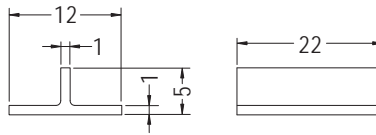

Part No.	Package
FHBBU-22	1000

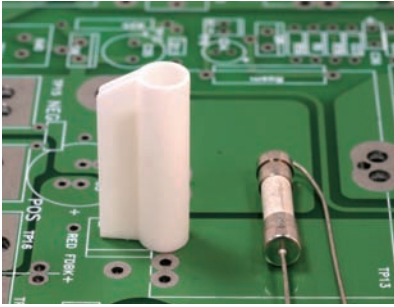

- Material: Nylon 66 (UL)
- Flame Class: 94V-2/94V-0
- Color: Natural/Black
- Unit: mm

用途：將保險絲固定於PCB板座上，拆卸方便。

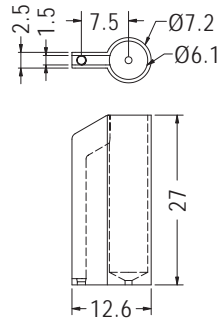

Part No.	Package
FUSCV-1	500

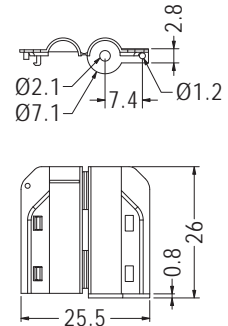
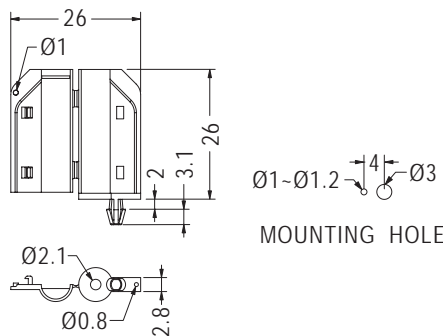

Part No.	Package
FUSCV-3	500

Part No.	Package
FUSCV-10	500



- Material: PBT (UL)
- Flame Class: 94V-0
- Color: Natural
- Unit: mm

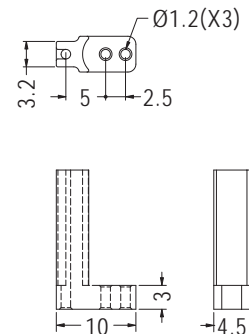
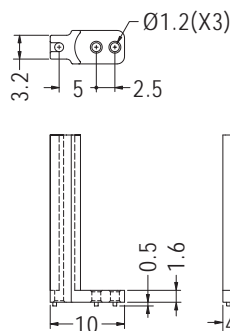

Part No.	Package
FUSCV-2	500

Part No.	Package
FUSCV-4	500

保險絲座 FUSE HOLDER

用途：將保險絲固定於PC板上，拆裝方便。

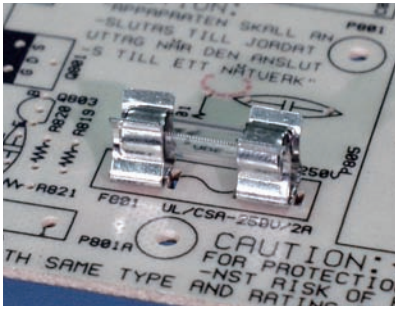

- Material: Bright Tin Plated Phosphor Bronze
- Unit: mm

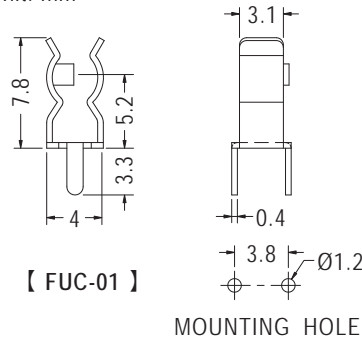

Part No.	適用保險絲 Cartridge Fuse	Package
FUC-01	Ø3.6	1000
FUC-02	Ø5.2	
FUC-17A	Ø5.2	

- Material: Bright Tin Plated Brass
- Unit: mm

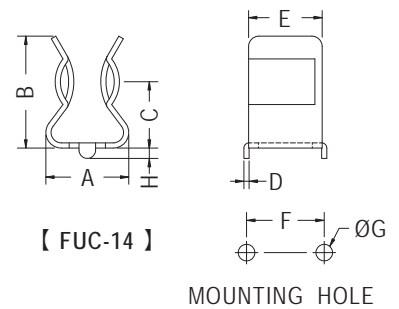
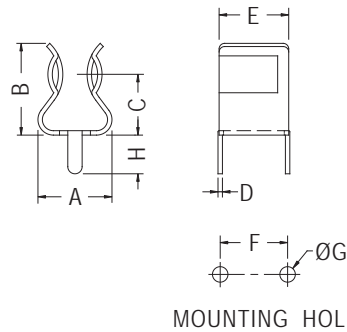
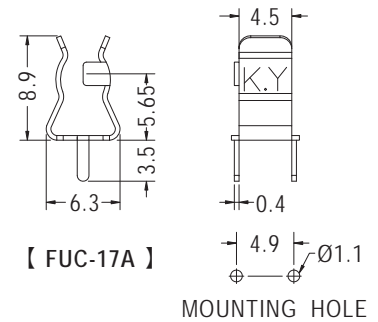
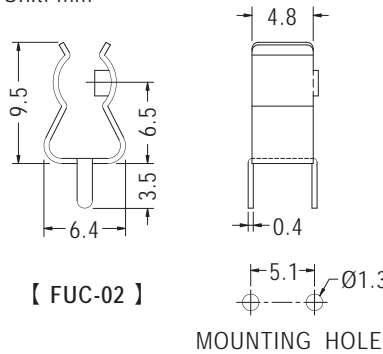

Part No.	A	B	C	D	E	F	G	H	適用保險絲 Cartridge Fuse	Package
FUC-03	6.8	8.3	5.5	0.4	6.3	6.0	1.4	3.6	Ø5.2	1000
FUC-03A	6.4	8.8	5.5	0.5	6.3	6.7	1.7	3.6	Ø5.2	
FUC-04	8.1	10.9	6.8	0.5	7.0	7.5	1.7	3.5	Ø6.3	
FUC-14	8.1	10.9	6.8	0.5	7.0	7.5	1.7	1.0	Ø6.3	



- Material: Nickel Plated Phosphor Bronze
- Unit: mm

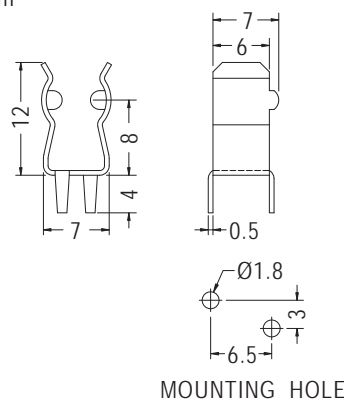

Part No.	適用保險絲 Cartridge Fuse	Package
FUC-09	Ø5.2	1000

保險絲座 FUSE HOLDER

用途：將保險絲固定於板座上，拆裝方便。

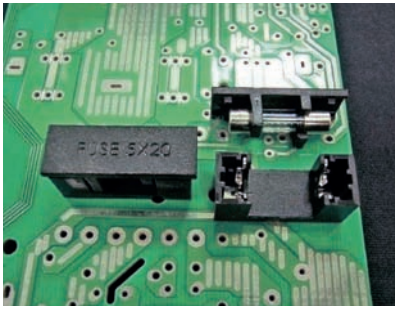

- Material: Nylon 66 (UL)
- Flame Class: 94V-2/94V-0
- Color: Black
- Unit: mm

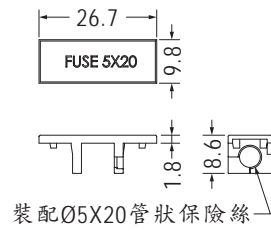

【 FUSEC-1B 】

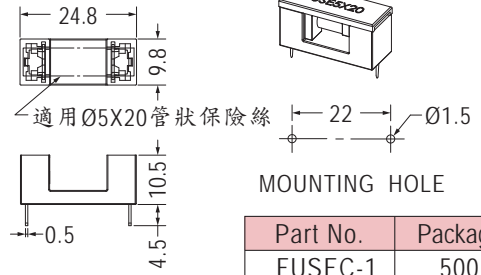

【 FUSEC-1E 】

Part No.	Package
FUSEC-1	500

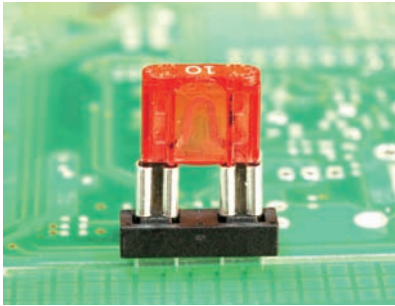

- Body Material: Nylon 66 (UL)
- Flame Class: 94V-2/94V-0
- Terminal Material: Tin Plated Brass
- Color: Natural/Black
- Unit: mm

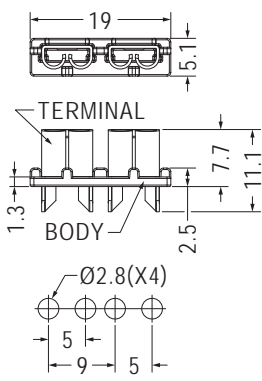

MOUNTING HOLE THICKNESS 1.6-2.0

Part No.	Package
FUSCV-6F	1000

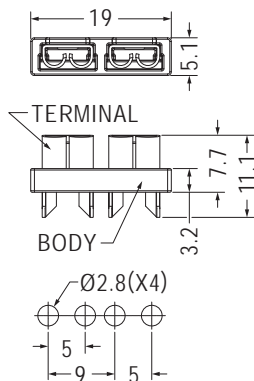

MOUNTING HOLE THICKNESS 1.6-2.0

Part No.	Package
FUSCV-7F	1000

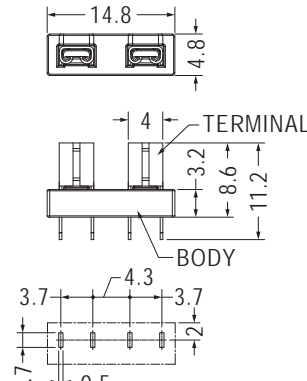

MOUNTING HOLE

Part No.	Package
FUSCV-8F	1000

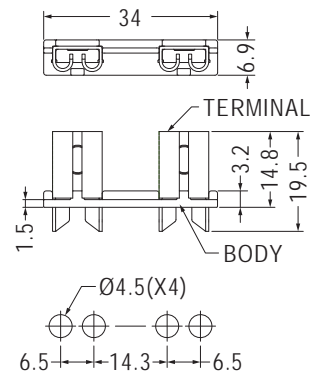

MOUNTING HOLE THICKNESS 3.0

Part No.	Package
FUSCV-12F	1000

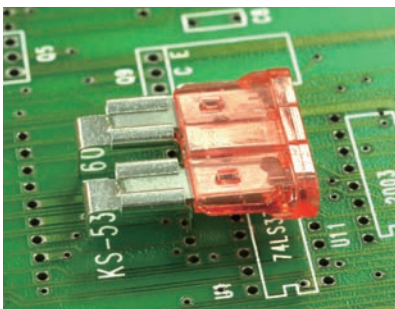

- Material: Bright Tin Plated Brass
- Unit: mm

用途：用於汽車保險絲。

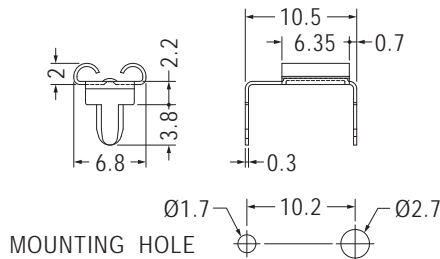

MOUNTING HOLE

Part No.	Package
FUC-5A	1000

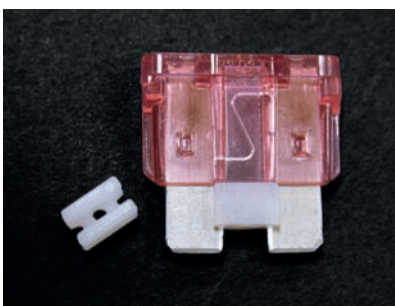

- Material: Nylon 66 (UL)
- Flame Class: 94V-2/94V-0
- Color: Natural/Black
- Unit: mm

用途：用於汽車保險絲之間隔、墊高作用。

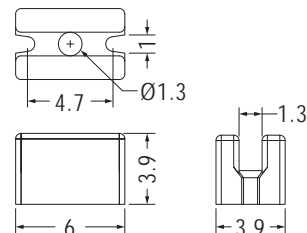

Part No.	Package
FUA-1	2000

PC板焊接端子 PCB TERMINAL

用途：PC板上之焊接電線端子，耐大電流，配合螺絲固定端子。

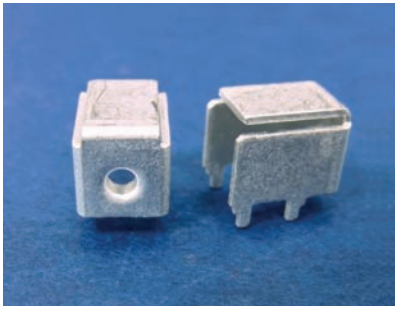

- Material: Tin Plated Brass
- Suggested Current: 15 Amps
- Unit: mm

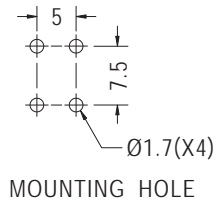
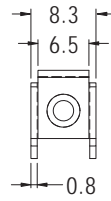
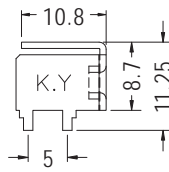
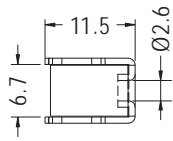

Part No.	Package
PCB-34	1000

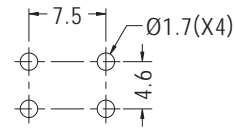
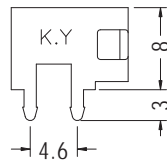
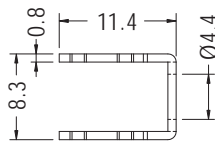
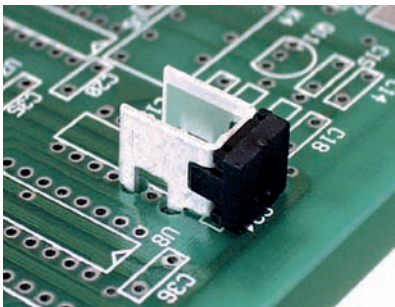

MOUNTING HOLE

Part No.	Package
PCB-21(4.4)	1000
組合件 (ASSY)	
PCB-21(4.4)F	PCB-21(4.4)+PCB-4CV

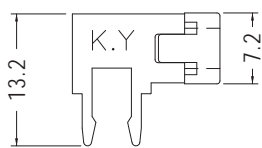
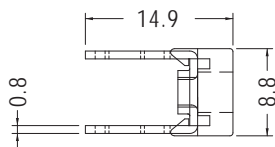

【 PCB-4F 】

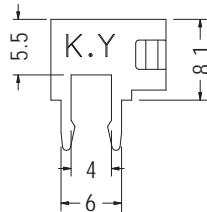
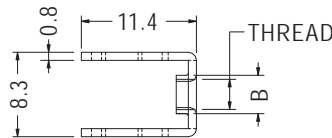

【 PCB-4 】

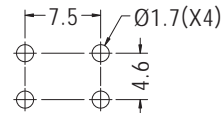

MOUNTING HOLE

Part No.	B	Thread	Package
PCB-4	3.5	M3X0.5P	1000
PCB-4(M4)	4.4	M4X0.7P	
PCB-4(632)	4.4	6-32 UNC	
組合件 (ASSY)			
PCB-4(M3)F	PCB-4+PCB-4CV		
PCB-4(M4)F	PCB-4(M4)+PCB-4CV		
PCB-4(632)F	PCB-4(632)+PCB-4CV		

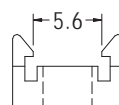
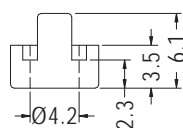
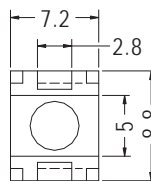

- Material: Nylon 66 (UL)
- Flame Class: 94V-2
- Color: Black

Part No.	Package
PCB-4CV	1000

PC板焊接端子 PCB TERMINAL

用途：PC板上之焊接電線端子，耐大電流，配合螺絲固定端子。

- Material: Tin Plated Brass
- Suggested Current: 15 Amps
- Unit: mm

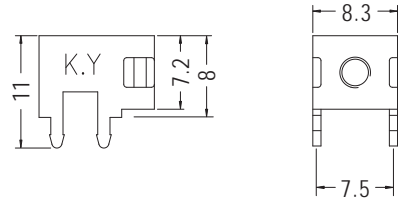
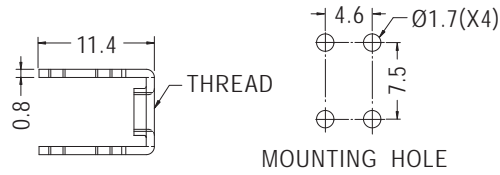
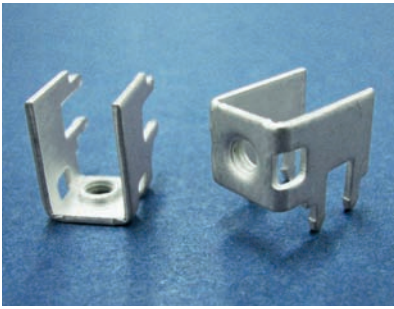

Part No.	Thread	Package
PCB-12	M3X0.5P	1000
PCB-12(M4)	M4X0.7P	
PCB-12(632)	6-32 UNC	

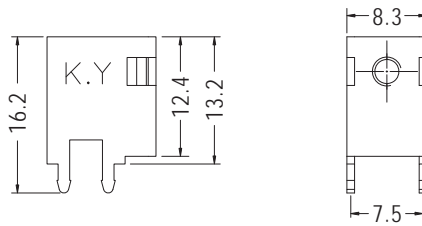
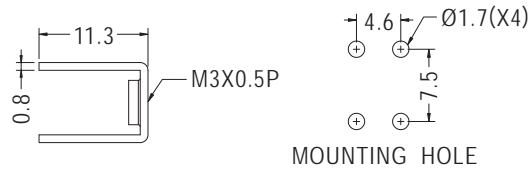
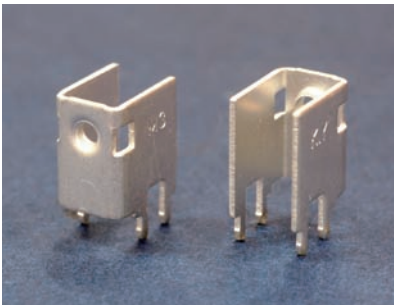

Part No.	Package
PCB-102	1000

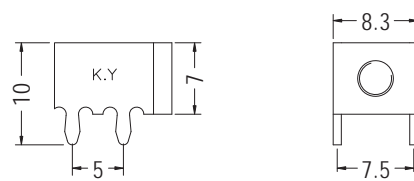
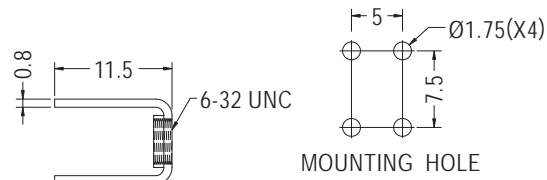
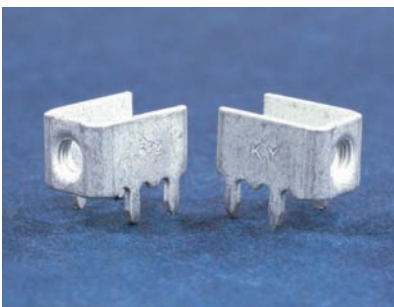

Part No.	Package
PCB-70	1000

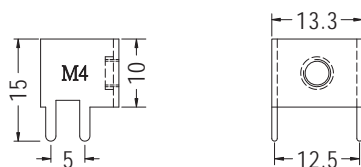
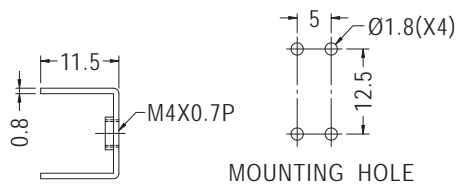
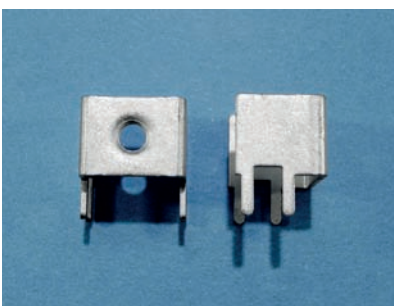

Part No.	Package
PCB-15(M4)	500

PC板焊接端子 PCB TERMINAL

用途：PC板上之焊接電線端子，耐大電流，配合螺絲固定端子。

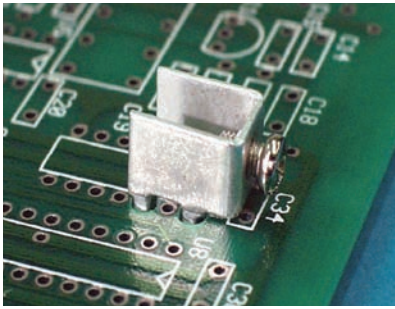

- Material: Tin Plated Brass
- Suggested Current: 15 Amps
- Unit: mm

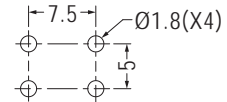
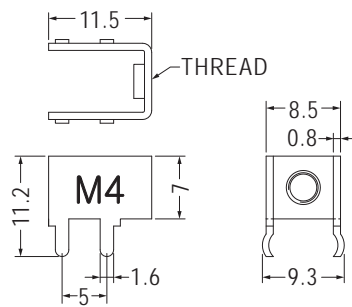

MOUNTING HOLE

Part No.	Thread	Package
PCB-2	M3X0.5P	1000
PCB-2(M4)	M4X0.7P	
PCB-2(6-32)	6-32 UNC	

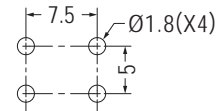
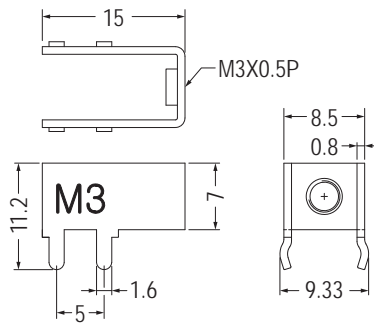

MOUNTING HOLE

Part No.	Package
PCB-78	1000

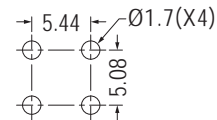
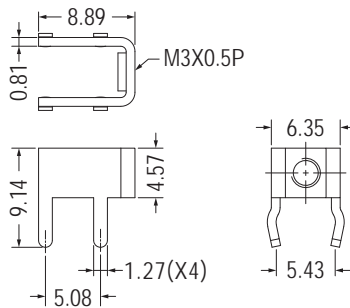

MOUNTING HOLE



Part No.	Package
PCB-128	1000

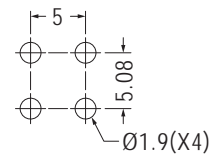
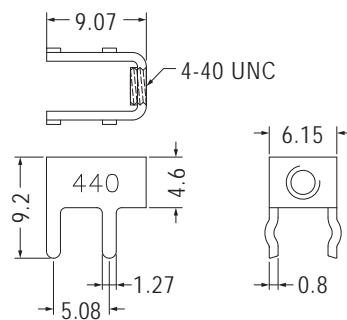

MOUNTING HOLE

Part No.	Package
PCB-477ST(440)	1000

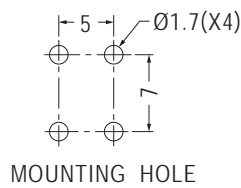
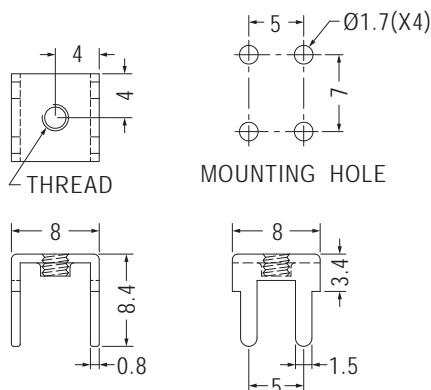

MOUNTING HOLE

Part No.	Thread	Package
PCB-1	M3X0.5P	1000
PCB-1(M4)	M4X0.7P	
PCB-1(6-32)	6-32 UNC	

PC板焊接端子 PCB TERMINAL

用途：PC板上之焊接電線端子，耐大電流，配合螺絲固定端子。



- Material: Tin Plated Brass
- Suggested Current: 15 Amps
- Unit: mm

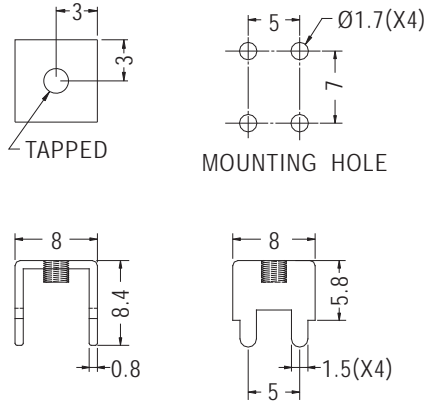
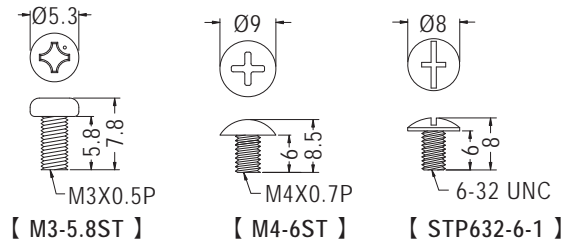

Part No.	Tapped	Package
PCB-11	M3X0.5P	1000
PCB-11(M3.5)	M3.5X0.6P	
PCB-11(M4)	M4X0.7P	
PCB-11(632)	6-32 UNC	
組合作 (ASSY)		
PCB-11M3-5.8F	PCB-11+M3-5.8ST	
PCB-11M4-6F	PCB-11(M4)+M4-6ST	
PCB-11(632)F	PCB-11(632)+STP632-6-1	

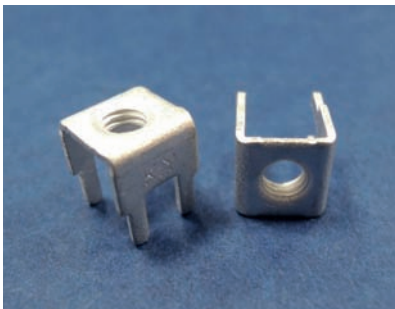

- Material: Tin Plated Brass
- Suggested Current: 15 Amps
- Unit: mm

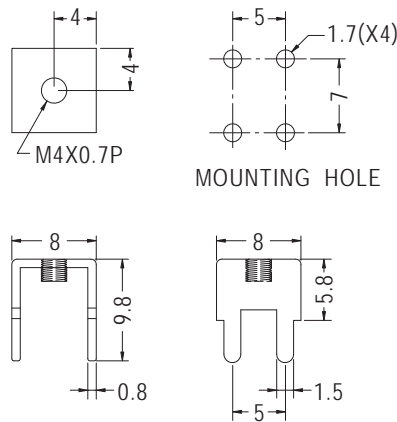

Part No.	Package
PCB-66	1000



- Material: Tin Plated Brass
- Suggested Current: 15 Amps
- Unit: mm

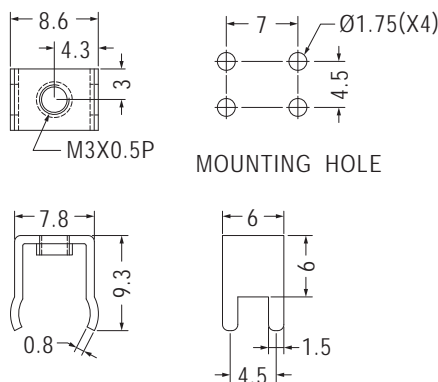

Part No.	Package
PCB-17	1000

PC板焊接端子 PCB TERMINAL

用途：PC板上之焊接電線端子，耐大電流，配合螺絲固定端子。

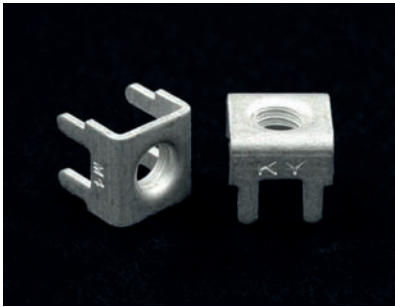

- Material: Tin Plated Brass
- Suggested Current: 15 Amps
- Unit: mm

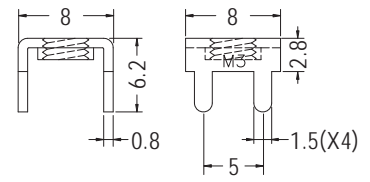
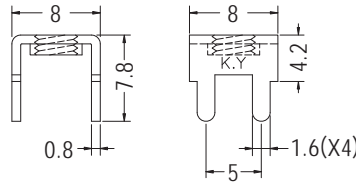
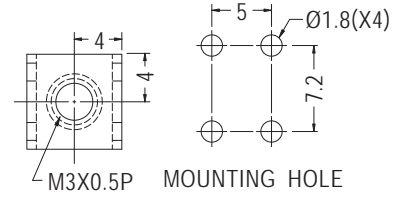
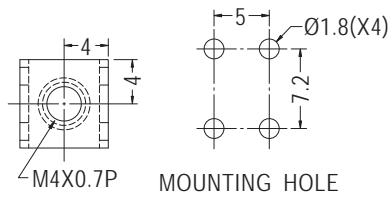

Part No.	Package
PCB-71	1000

Part No.	Package
PCB-75	1000

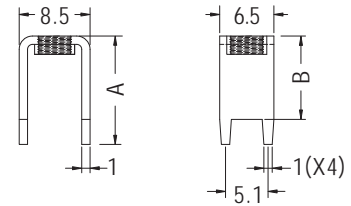
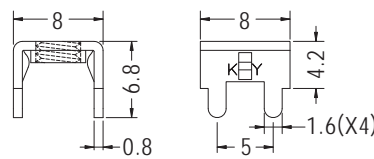
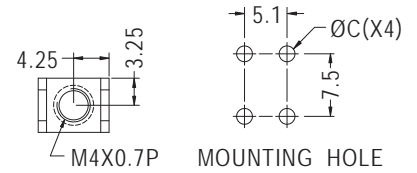
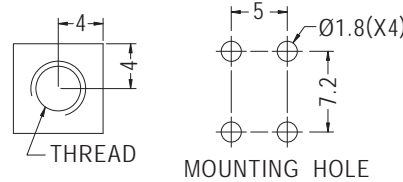

Part No.	Thread	Package
PCB-9-1	M3X0.5P	1000
PCB-9-1(M4)	M4X0.7P	
PCB-9-1(632)	6-32 UNC	

Part No.	A	B	C	Package
PCB-37M4	8.0	5.0	1.7	1000
PCB-58M4	13.0	10.0	1.9	

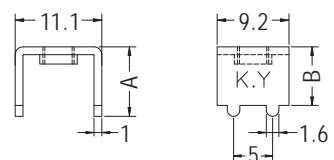
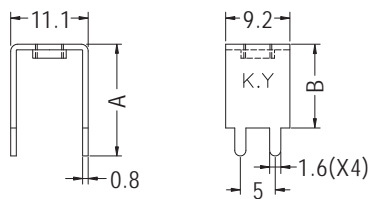
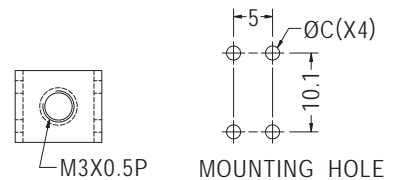
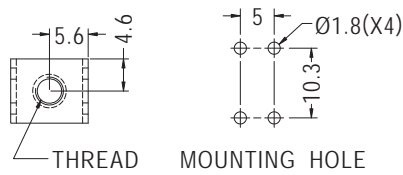

Part No.	A	B	Thread	Package
PCB-27(M3)	16.0	12.0	M3X0.5P	1000
PCB-27(M4)	16.0	12.0	M4X0.7P	
PCB-28(M3)	18.8	14.8	M3X0.5P	
PCB-28(M4)	18.8	14.8	M4X0.7P	

Part No.	A	B	C	Package
PCB-18	8.9	7.5	1.8	1000
PCB-106	22.25	18.25	1.9	500

PC板焊接端子 PCB TERMINAL

用途：PC板上之焊接電線端子，耐大電流，配合螺絲固定端子。



- Material: Tin Plated Brass
- Suggested Current: 20 Amps
- Unit: mm

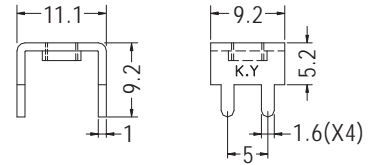
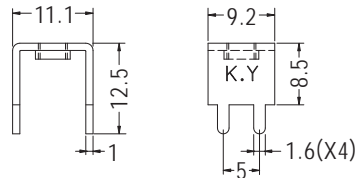
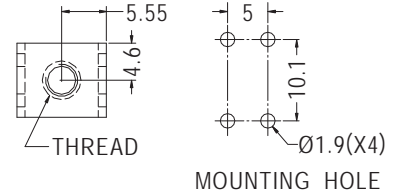
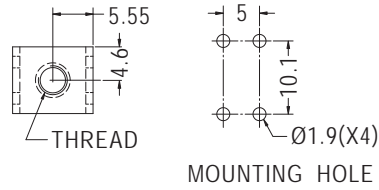

Part No.	Thread	Package
PCB-7	M3X0.5P	1000
PCB-7(M4)	M4X0.7P	
PCB-7(632)	6-32 UNC	

Part No.	Thread	Package
PCB-8	M3X0.5P	1000
PCB-8(M4)	M4X0.7P	
PCB-8(632)	6-32 UNC	

PC板焊接端子加螺絲(附四角華司) PCB TERMINAL

用途：PC板上之焊接電線端子，耐大電流，配合螺絲固定端子。



- Material: Tin Plated Brass
- Suggested Current: 15 Amps
- Unit: mm

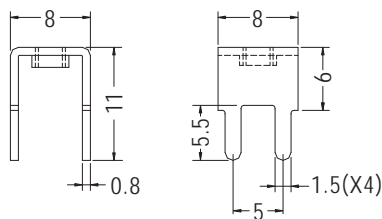
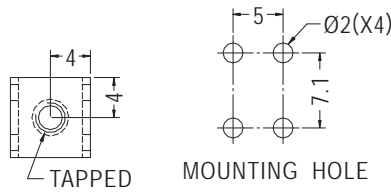

Part No.	Tapped	Package
PCB-10A(M3)	M3X0.5P	1000
PCB-10A	M3.5X0.6P	
PCB-10AM4	M4X0.7P	
PCB-10A(632)	6-32 UNC	

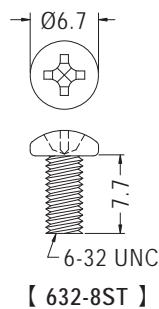
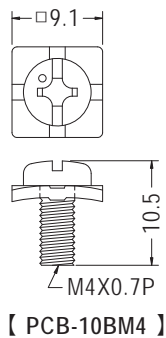
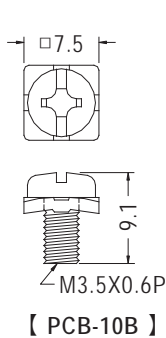

組套件 (ASSY)	
PCB-10	PCB-10A+PCB-10B
PCB-10M4F	PCB-10AM4+PCB-10BM4
PCB-10(632)F	PCB-10A(632)+632-8ST

PC板焊接端子 PCB TERMINAL

用途：PC板上之焊接電線端子，耐大電流，配合螺絲固定端子。

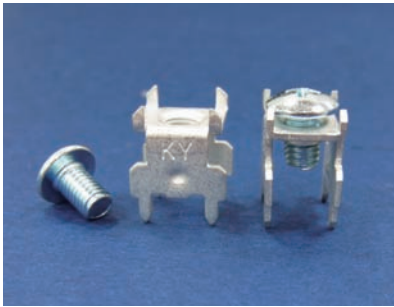

- Material: Tin Plated Brass
- Suggested Current: 20 Amps
- Unit: mm

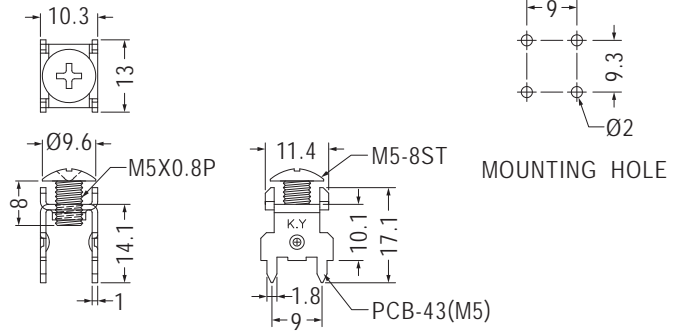

Part No.	組合作 (ASSY)	Package
PCB-43(M5)F	PCB-43(M5)+M5-8ST	500



- Material: Tin Plated Brass
- Suggested Current: 30 Amps
- Unit: mm

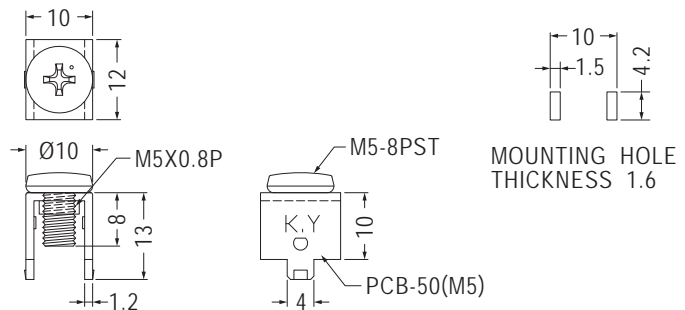

Part No.	組合作 (ASSY)	Package
PCB-50M5F	PCB-50(M5)+M5-8PST	500



- Material: Tin Plated Brass
- Suggested Current: 15 Amps
- Unit: mm

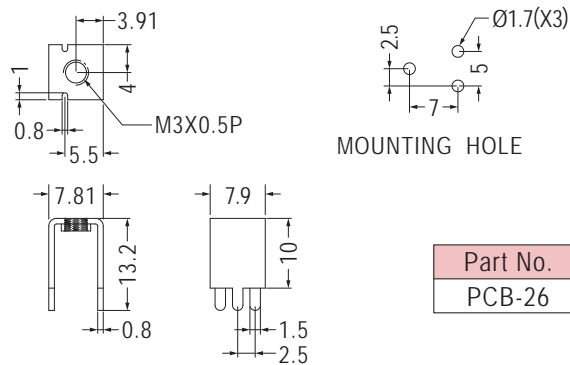

Part No.	Package
PCB-26	1000



- Material: Tin Plated SPCC
- Suggested Current: 15 Amps
- Unit: mm

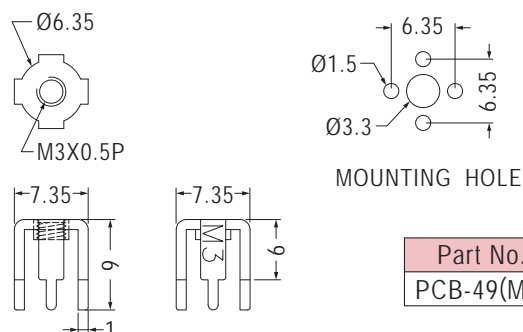

Part No.	Package
PCB-49(M3)	1000

PC板焊接端子 PCB TERMINAL

用途：PC板上之焊接電線端子，耐大電流，配合螺絲固定端子。

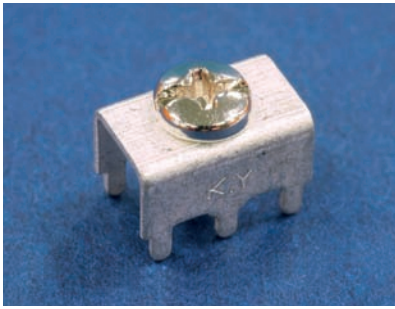

- Terminal Material: Tin Plated Brass
- Screw Material: Nickel Plated Steel
- Suggested Current: 30 Amps
- Unit: mm

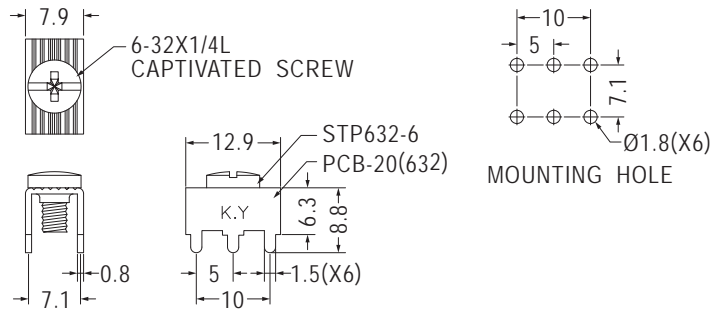

Part No.	組零件(ASSY)	Package
PCB-20(632)F	PCB-20(632)+STP632-6	1000

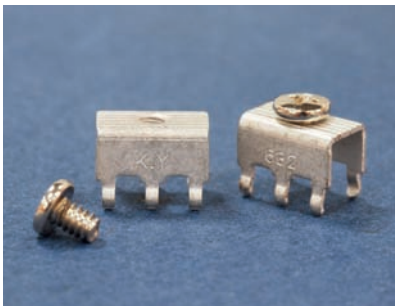

- Material: Tin Plated Brass
- Suggested Current: 30 Amps
- Unit: mm

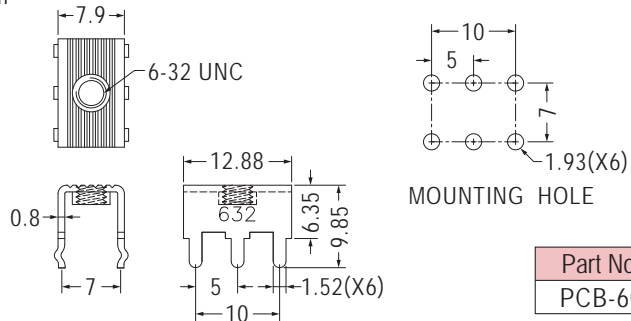

Part No.	Package
PCB-60	1000

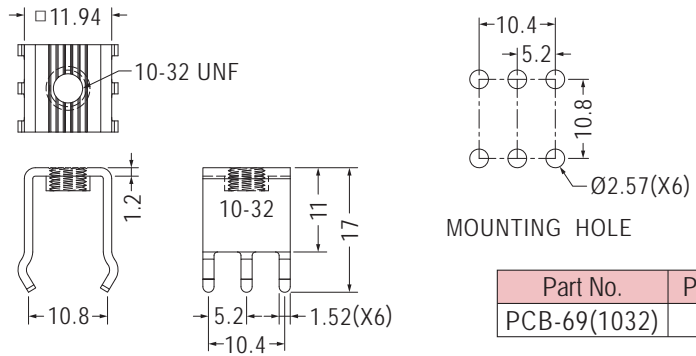
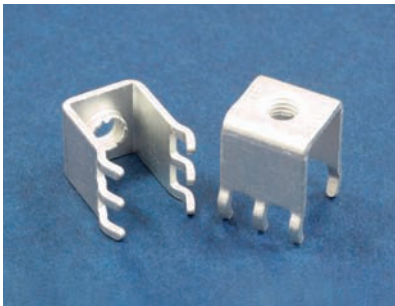

Part No.	Package
PCB-69(1032)	1000

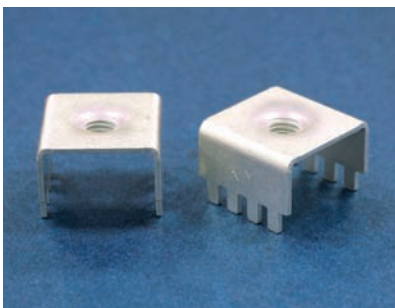

- Material: Tin Plated Copper
- Suggested Current: 50 Amps
- Unit: mm

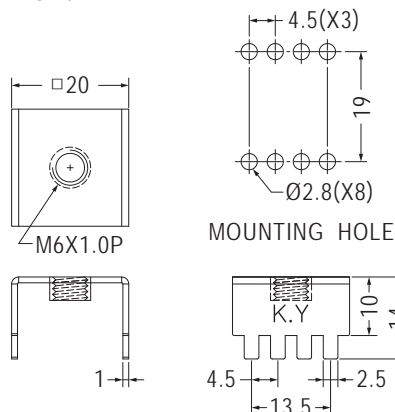

Part No.	Package
PCB-82	250

- Material: Tin Plated Copper
- Suggested Current: 250 Amps
- Unit: mm

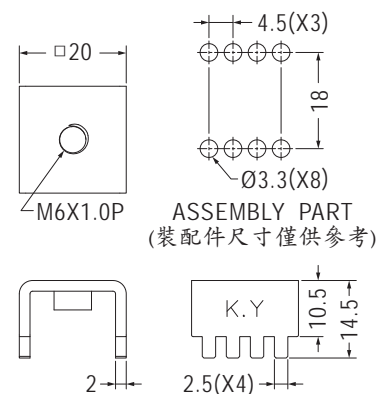

Part No.	Package
★PCB-82-1	250

PC板焊接端子 PCB TERMINAL

用途：焊接於PC板上，另一端插接端子。



- Material: Tin Plated Brass
- Suggested Current: 15 Amps
- Unit: mm

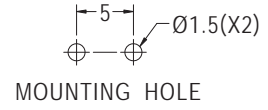
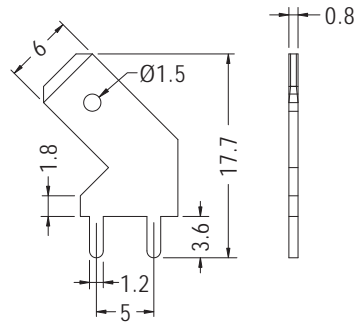

Part No.	Package
PCRL250	1000



- Material: Tin Plated Brass
- Unit: mm

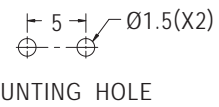
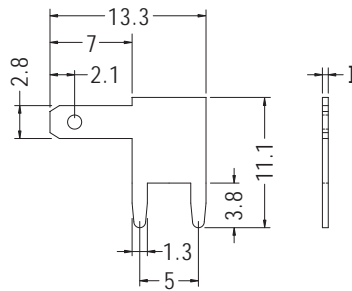

Part No.	I	Suggested Current	Package
PCF110	0.5	10 Amps	1000
PCF1108	0.8	15 Amps	

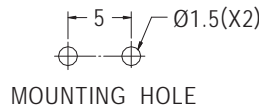
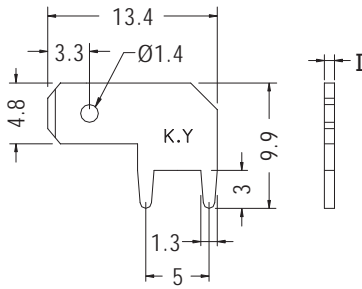

Part No.	I	Suggested Current	Package
PCF187(5)	0.5	10 Amps	1000
PCF187	0.8	15 Amps	



- Material: Tin Plated Brass
- Suggested Current: 15 Amps
- Unit: mm

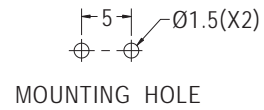
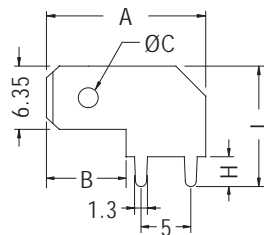

Part No.	A	B	C	H	L	Package
PCF250	16.0	8.0	2.0	3.0	12.1	1000
PCF250-11	20.0	12.3	1.7	3.8	12.7	

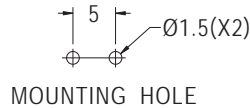
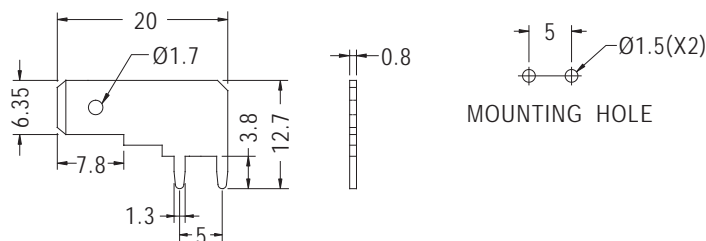

Part No.	Package
PCFL250	1000

PC板焊接端子 PCB TERMINAL

用途：PC板上之焊接端子。



- Material: Tin Plated Brass
- Suggested Current: 15 Amps
- Unit: mm

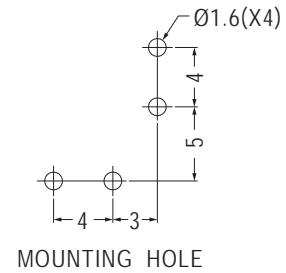
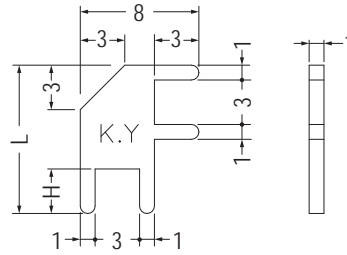

Part No.	H	L	Package
PCLT-10	3.0	10.0	1000
PCLT-11	4.0	11.0	

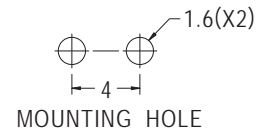
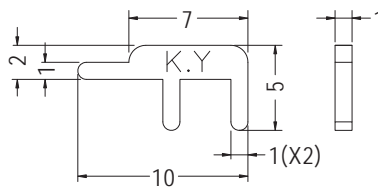

Part No.	Package
PCLTA-1	1000



- Material: Tin Plated Brass
- Suggested Current: 25 Amps
- Unit: mm

用途：PC板上之焊接電線端子，美觀、牢固、耐電流大，配合螺絲固定端子。

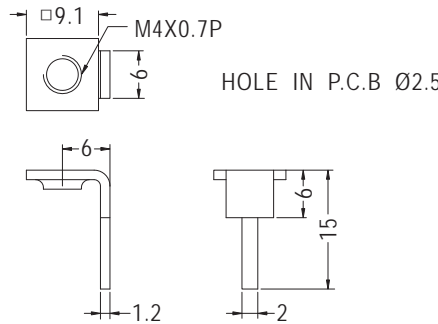

Part No.	Package
PCB-22(M4)	1000

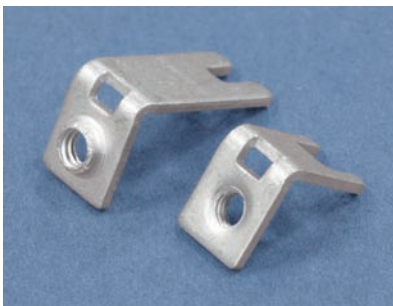

- Material: Tin Plated Brass
- Unit: mm

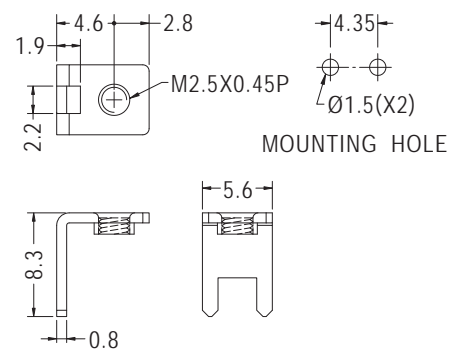
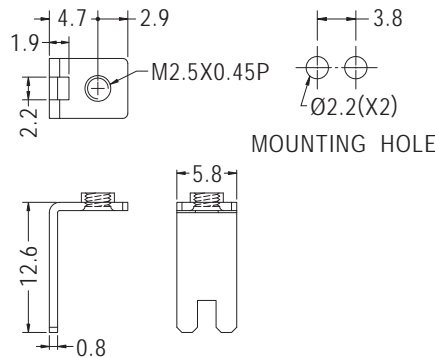

Part No.	Suggested Current	Package
PCB-73	20 Amps	1000

Part No.	Suggested Current	Package
PCB-74	15 Amps	1000

PC板焊接端子 PCB TERMINAL

用途：PC板上之插接電線端子，美觀、牢固、耐電流大，配合螺絲固定端子。

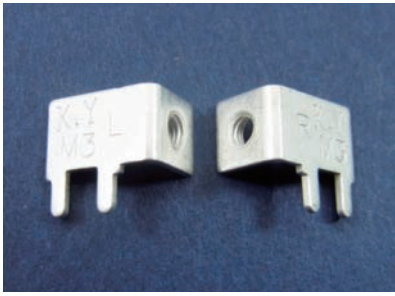

- Material: Tin Plated Brass
- Suggested Current: 15 Amps
- Unit: mm

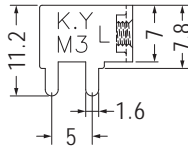
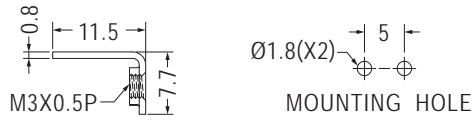

Part No.	Package
PCB-54L(M3)	1000

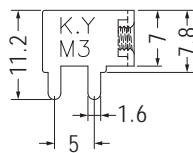
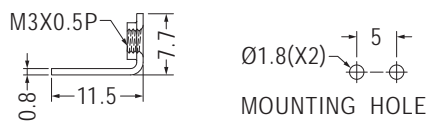
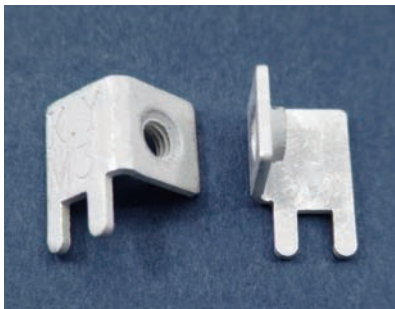

Part No.	Package
PCB-54R(M3)	1000

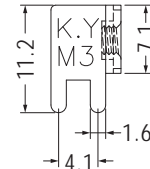
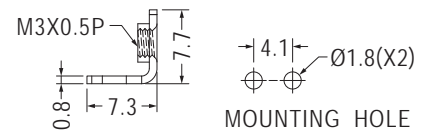

Part No.	Package
PCB-55(M3)	1000

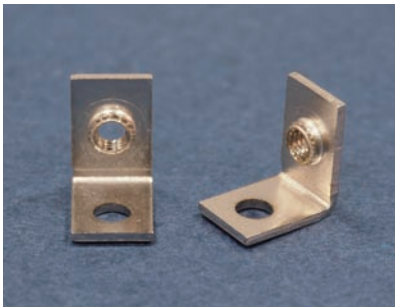

- Material: Nickel Plated Steel
- Unit: mm

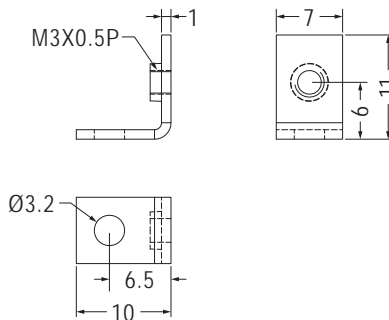

Part No.	Package
PCB-99	1000

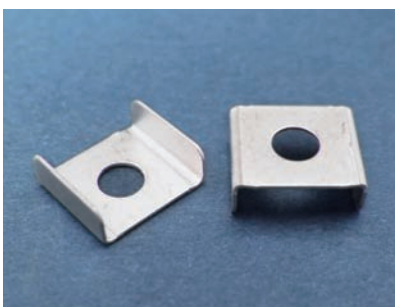

- Material: Tin Plated Brass
- Unit: mm

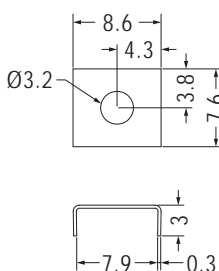

Part No.	Package
PCB-25(3.2)	1000

PC板焊接端子 PCB TERMINAL

用途：PC板上之焊接電線端子，美觀、牢固、耐電流大，配合螺絲固定端子。

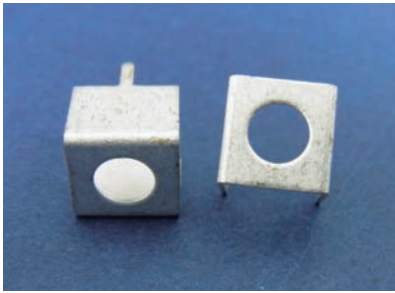

- Material: Tin Plated Brass
- Suggested Current: 10 Amps
- Unit: mm

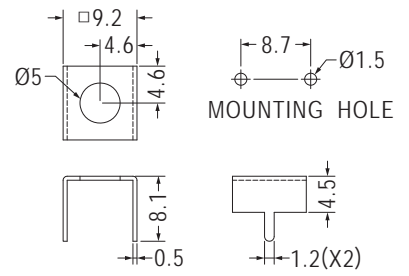
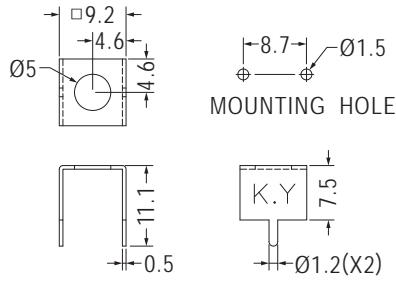

Part No.	Package
PCB-29	1000

Part No.	Package
PCB-44	1000

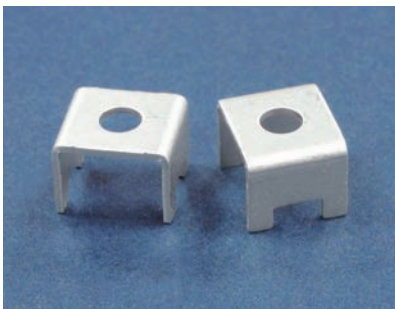

- Material: Tin Plated Brass
- Suggested Current: 30 Amps
- Unit: mm

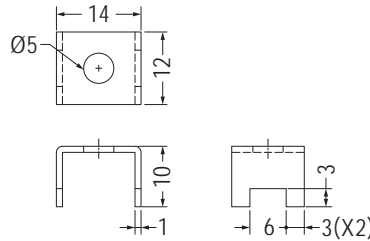

Part No.	Package
PCB-77	1000



- Material: Tin Plated Phosphor Bronze
- Suggested Current: 30 Amps
- Unit: mm

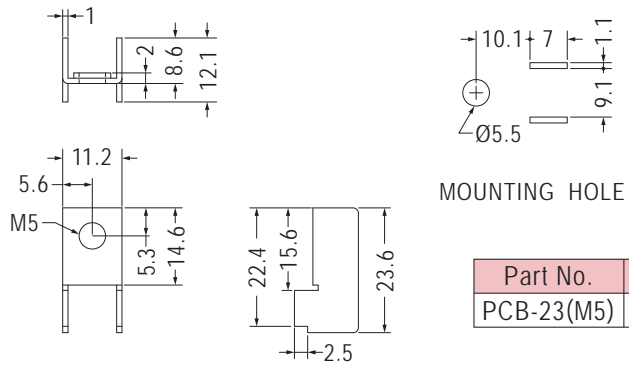

Part No.	Package
PCB-23(M5)	1000

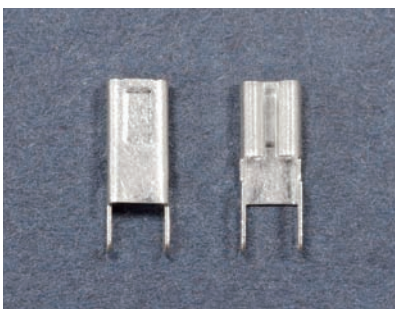

- Material: Tin Plated Brass
- Suggested Current: 10 Amps
- Unit: mm

用途：PC板上之焊接電線端子或汽車保險絲，耐電流大。

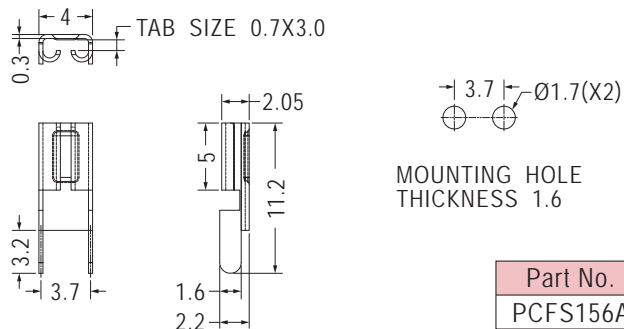

Part No.	Package
PCFS156A	1000

PC板焊接端子 PCB TERMINAL

用途：焊接於PC板上，另一端插接公端，耐電流大。

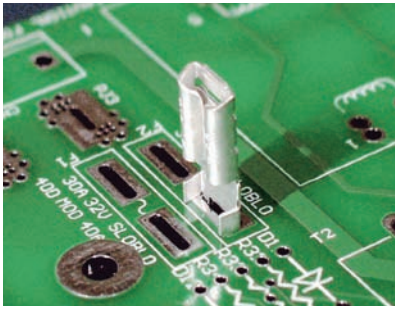

- Material: Tin Plated Brass
- Suggested Current: 10 Amps @ 500V AC
- Unit: mm

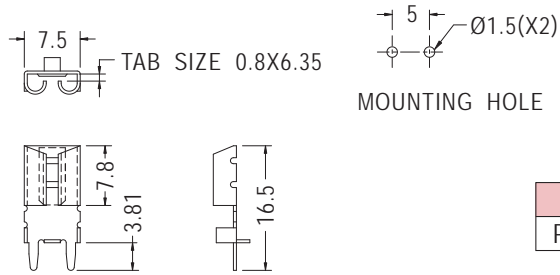

Part No.	Package
PCFS250L	1000

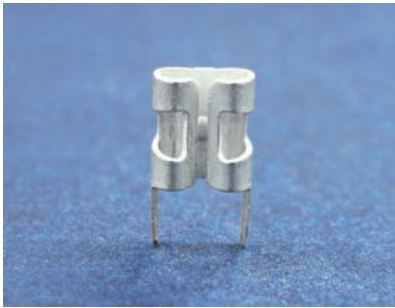

- Material: Tin Plated Brass
- Suggested Current: 10 Amps @ 500V AC
- Unit: mm

用途：PC板上之焊接電線端子或汽車保險絲，耐電流大。

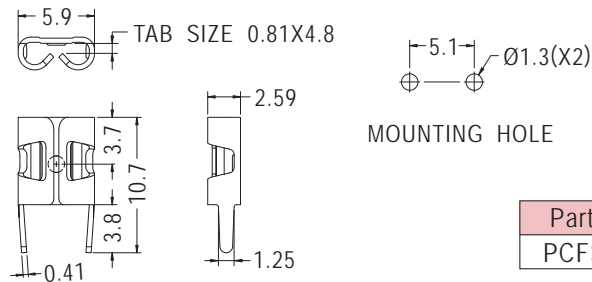

Part No.	Package
PCFS187	1000



- Material: Bright Tin Plated Brass
- Suggested Current: 30 Amps @ 500V AC
- Unit: mm

用途：PC板上之焊接電線端子或汽車保險絲，耐電流大。

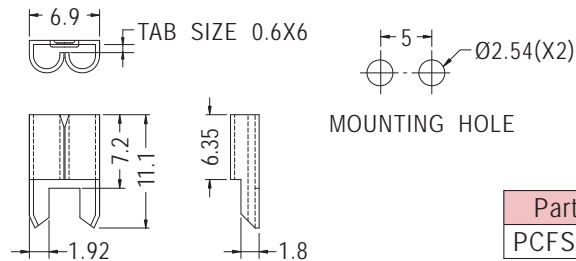

Part No.	Package
PCFS2509A	1000



- Material: Tin Plated Brass
- Suggested Current: 30 Amps @ 500V AC
- Unit: mm

用途：PC板上之焊接電線端子或汽車保險絲，耐電流大。

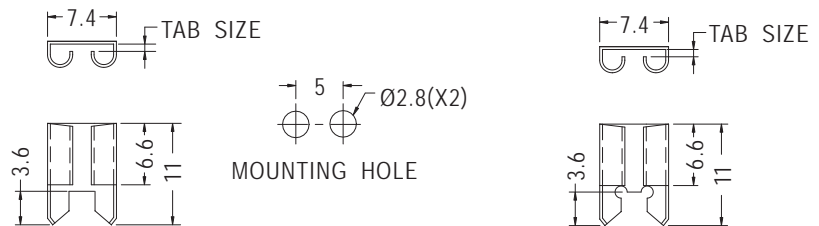

Part No.	Tab Size	Package
PCFS2505	0.5X6.35	1000
PCFS2508	0.8X6.35	

Part No.	Tab Size	Package
PCFS2505A	0.5X6.35	1000
PCFS2508A	0.8X6.35	

PC板焊接端子 PCB TERMINAL

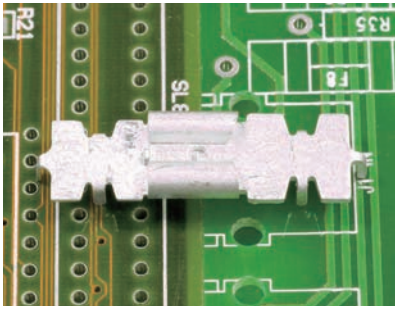

- Material: Tin Plated Brass
- Suggested Current: 10 Amps
- Unit: mm

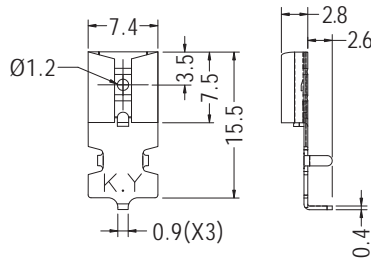

用途：兩個端子對接焊於PC板上，牢固，不動搖。

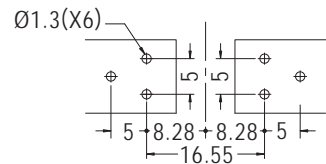

COMBINATION ILLUSTRATION DWG MOUNTING HOLE

Part No.	Package
PCLTM-250	1000

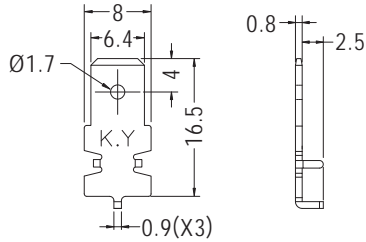

MOUNTING HOLE

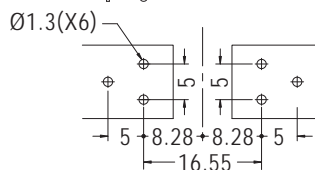

COMBINATION ILLUSTRATION DWG MOUNTING HOLE

Part No.	Package
PCLT-250	1000

焊接端子 PIN TERMINAL



- Material: Tin Plated Brass
- Suggested Current: 10 Amps
- Unit: mm

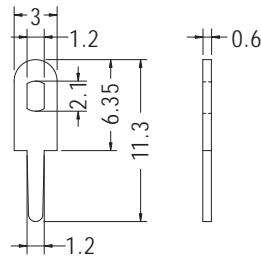

HOLE IN P.C.B Ø1.2~Ø1.3

用途：PC板上之焊接電線端子，美觀、牢固。

Part No.	Package
PIN-1	2000



- Material: Tin Plated Brass
- Suggested Current: 30 Amps
- Unit: mm

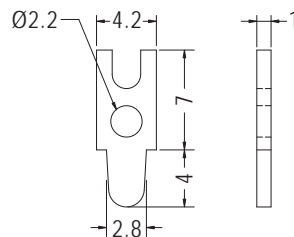

HOLE IN P.C.B Ø3.0

Part No.	Package
PIN-2	2000



- Material: Nickel Plated Brass
- Suggested Current: 15 Amps
- Unit: mm

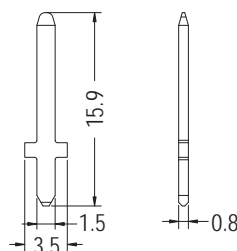

HOLE IN P.C.B Ø1.7

Part No.	Package
PIN-9	2000

PC板焊接端子 PCB TERMINAL

用途：焊接於PC板上，另一端插接端子。



- Material: Tin Plated Brass
- Suggested Current: 10 Amps
- Unit: mm

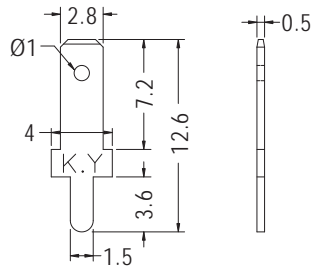

HOLE IN P.C.B Ø1.7

Part No.	Package
PC110	2000



- Material: Plated Nickel Brass/Plated Tin Brass
- Suggested Current: 15 Amps
- Unit: mm

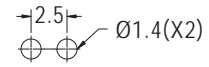
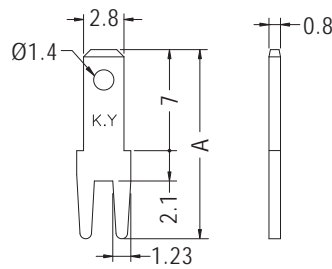

MOUNTING HOLE

Part No.	A	Package
PC110-1	13.1	2000
PC110-4	12.1	



- Material: Tin Plated Brass
- Unit: mm

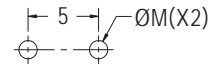
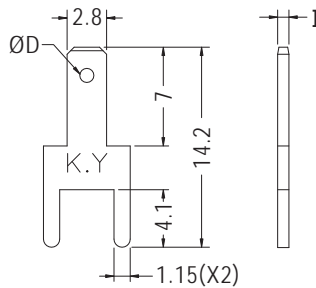

MOUNTING HOLE

Part No.	D	I	M	Suggested Current	Package
PC110D5	1.0	0.5	1.3	10 Amps	2000
PC110D5-1	1.3	0.5	1.3	10 Amps	
PC110D8	0.8	0.8	1.5	15 Amps	

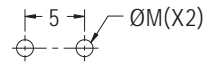
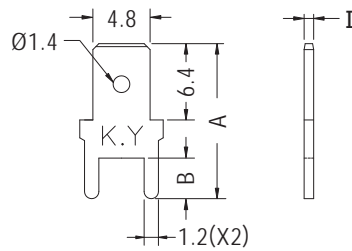

MOUNTING HOLE

Part No.	A	B	I	M	Suggested Current	Package
PC187	13.0	3.4	0.5	1.4	10 Amps	2000
PC187(0.8)	13.0	3.4	0.8	1.5	15 Amps	
PC187-16-1	11.9	2.3	0.8	1.4	15 Amps	

PC板焊接端子 PCB TERMINAL

用途：焊接於PC板上，另一端插接端子。

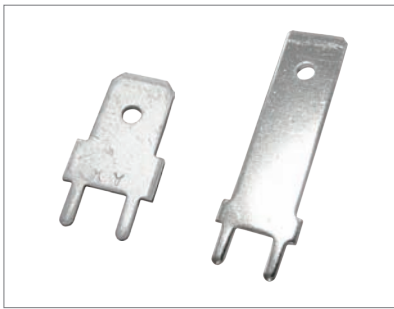

- Material: Tin Plated Brass
- Suggested Current: 15 Amps
- Unit: mm

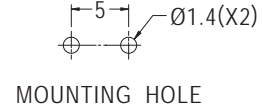
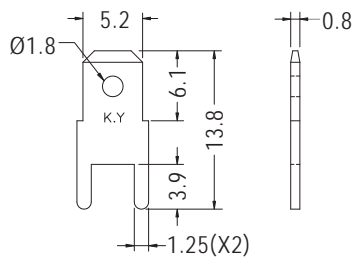

Part No.	Package
PC205	2000

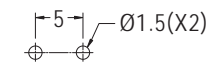
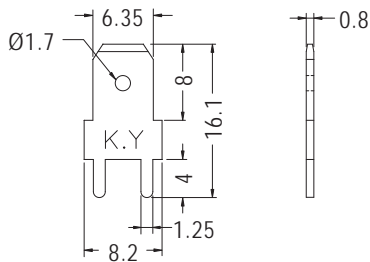

Part No.	Package
PC250	1000

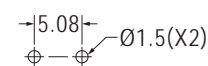
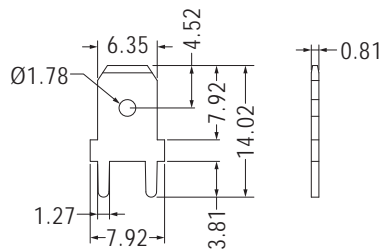

Part No.	Package
PC250-8	1000

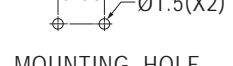
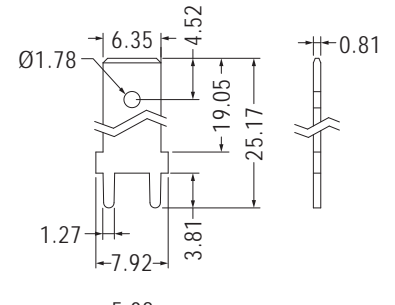

• Material: Nickel Plated Brass

Part No.	Package
PC250-4	1000

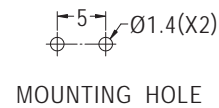
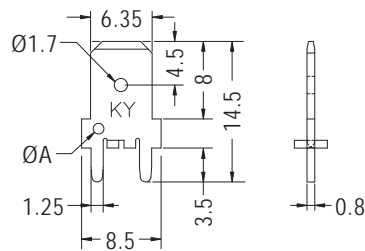
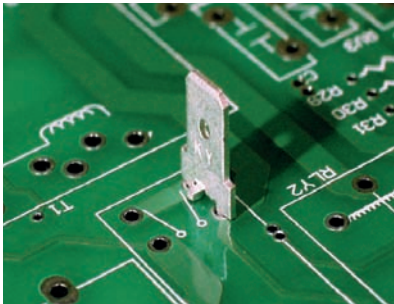

Part No.	A	Package
PCH250		1000
PCH250-1	1.1	

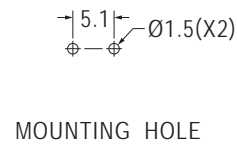
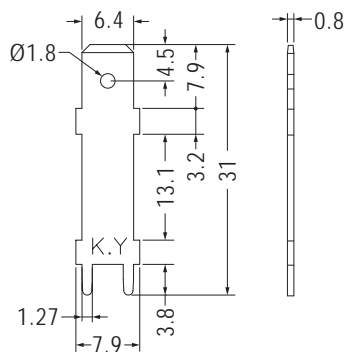
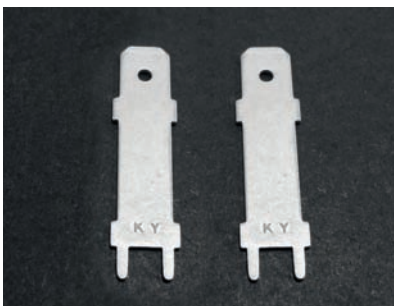

Part No.	Package
PC250-11	1000

PC板焊接端子 PCB TERMINAL

用途：焊接於PC板上，另一端插接端子。



- Material: Tin Plated Brass
- Suggested Current: 15 Amps
- Unit: mm

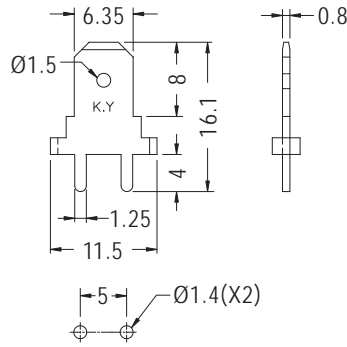

MOUNTING HOLE

Part No.	Package
PCR250	1000

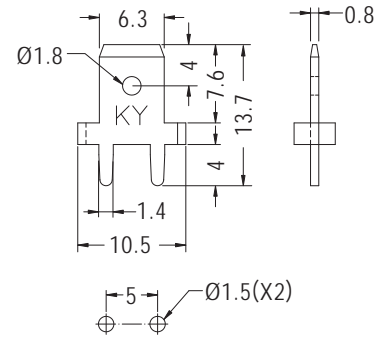

MOUNTING HOLE

Part No.	Package
PCR250-S	1000



- Material: Tin Plated Brass
- Suggested Current: 15 Amps
- Unit: mm

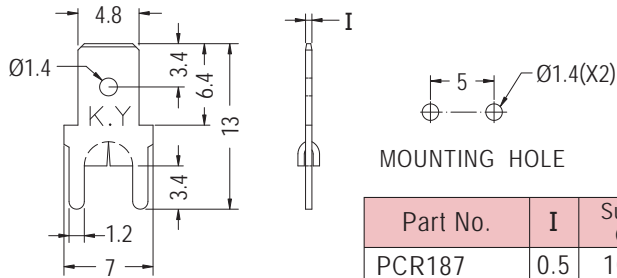

MOUNTING HOLE

Part No.	I	Suggested Current	Package
PCR187	0.5	10 Amps	1000
PCR187(0.8)	0.8	15 Amps	

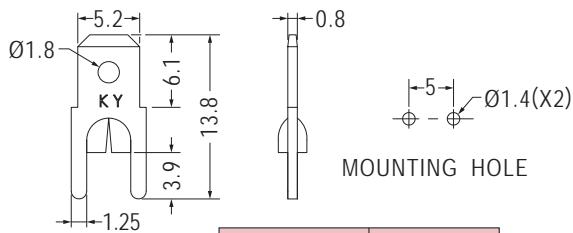

MOUNTING HOLE

Part No.	Package
PCRS205	1000

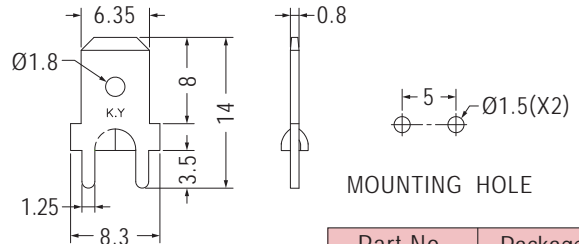

MOUNTING HOLE

Part No.	Package
PCRS250	1000

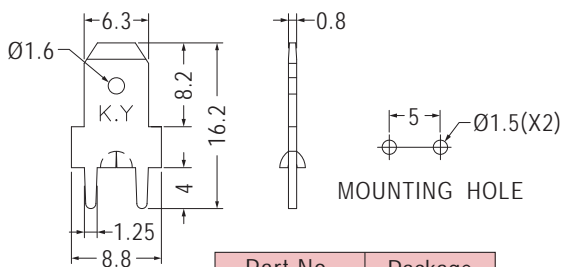

MOUNTING HOLE

Part No.	Package
PCRS250-1	1000

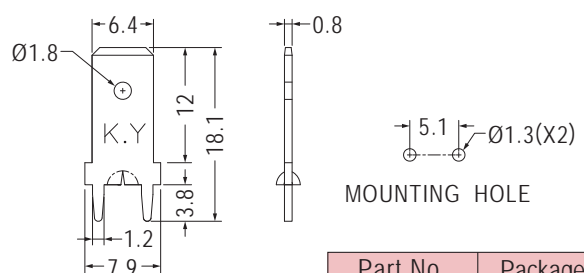

MOUNTING HOLE

Part No.	Package
PCRS250-2	1000

PC板焊接端子 PCB TERMINAL

用途：焊接於PC板上，另一端插接端子，牢固不動搖。

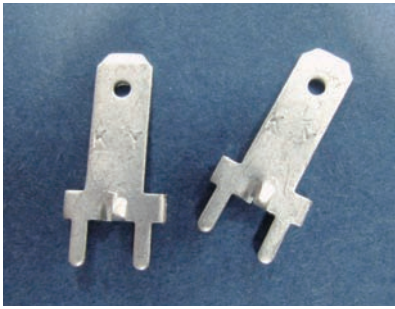

- Material: Tin Plated Brass
- Suggested Current: 15 Amps
- Unit: mm

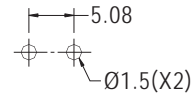
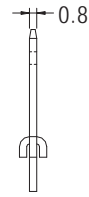
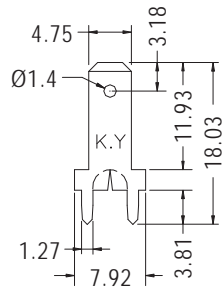

MOUNTING HOLE

Part No.	Package
PCRS187A	1000



- Material: Tin Plated Brass
- Suggested Current: 35 Amps
- Unit: mm

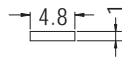
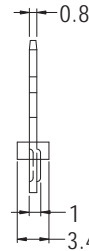
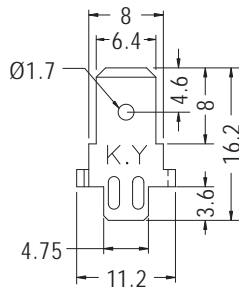

MOUNTING HOLE

Part No.	Package
PCRN250	1000

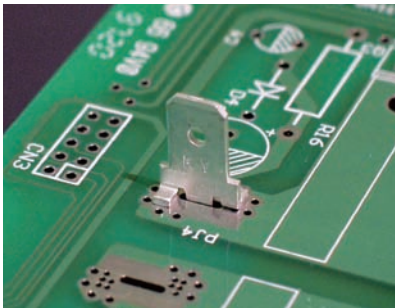

- Material: Tin Plated Brass
- Suggested Current: 25 Amps
- Unit: mm

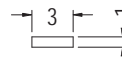
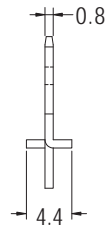
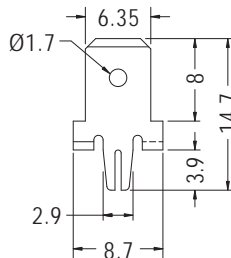

MOUNTING HOLE

Part No.	Package
PCK250	1000

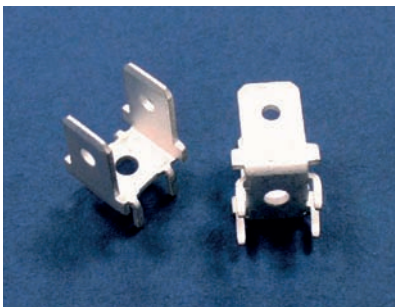

- Material: Tin Plated Brass
- Suggested Current: 20 Amps
- Unit: mm

用途：PC板上之焊接端子，美觀，牢固。

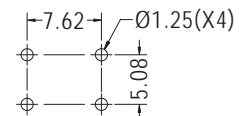
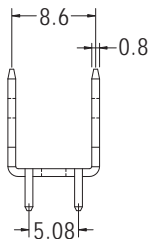
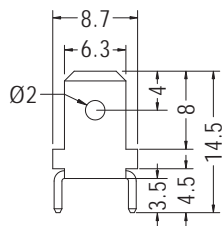

MOUNTING HOLE

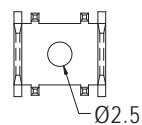

Part No.	Package
PCU250	1000

PC板焊接端子 PCB TERMINAL

用途：PC板上之焊接端子，美觀，牢固。

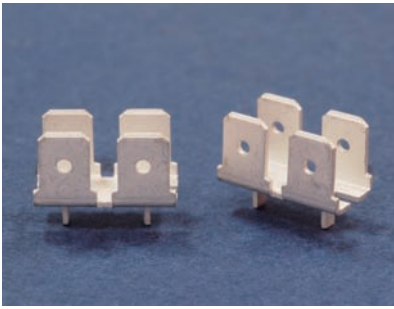

- Material: Tin Plated Brass
- Suggested Current: 20 Amps
- Unit: mm

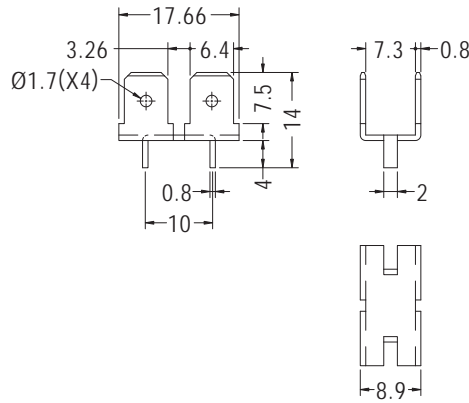

Part No.	Package
PCB-100	1000

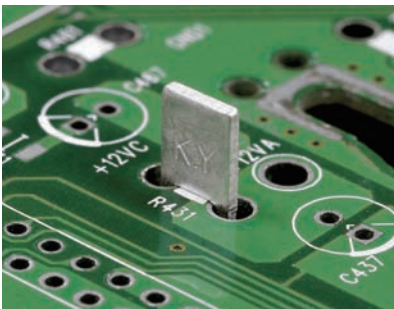

- Material: Tin Plated Brass
- Unit: mm

用途：焊接於PC板上，另一端插接端子。

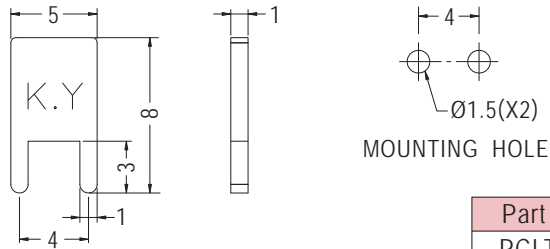

Part No.	Package
PCLTA-2	1000



- Material: Tin Plated Brass
- Unit: mm

用途：PC板上之焊接端子，美觀，牢固。

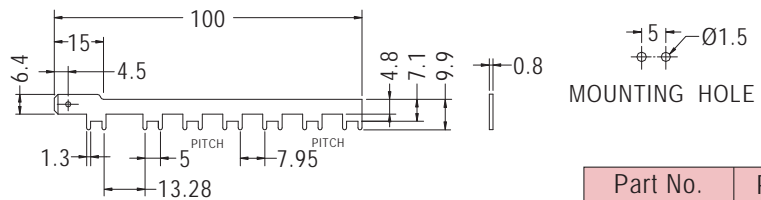

Part No.	Package
PCF250-7	500



- Material: Tin Plated Brass
- Suggested Current: 15 Amps
- Unit: mm

用途：PC板上之焊接電線端子，耐大電流。

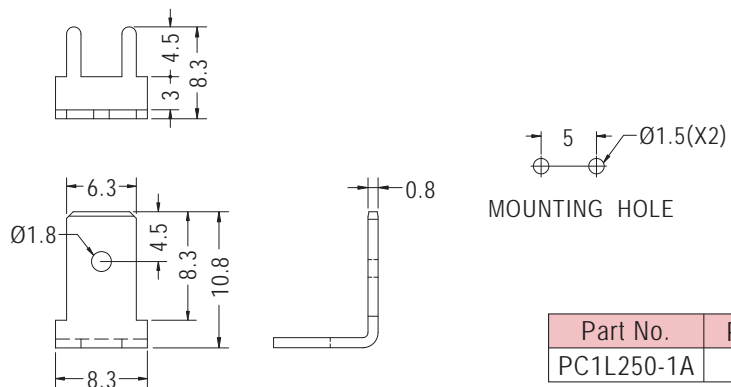

Part No.	Package
PC1L250-1A	1000

PC板焊接端子 PCB TERMINAL

用途：PC板上之焊接電線端子，耐大電流。



- Material: Tin Plated Brass
- Suggested Current: 15 Amps
- Unit: mm

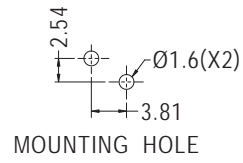
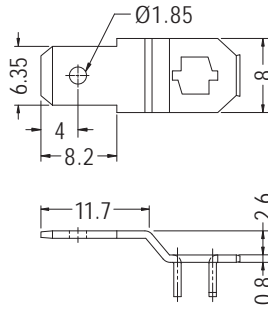

Part No.	Package
PC1L250-7	1000

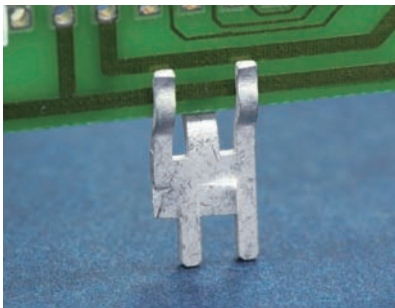

- Material: Tin Plated Brass
- Suggested Current: 5 Amps
- Unit: mm

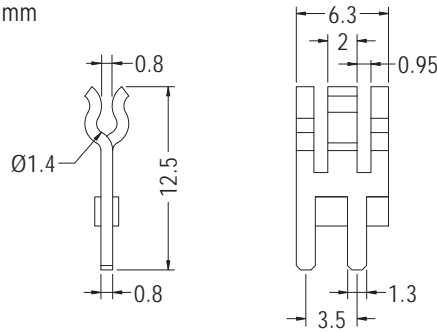

Part No.	Package
EM-408	1000



- Material: Tin Plated Brass
- Unit: mm

用途：可用螺絲鎖於PC板上，另一端插接端子。

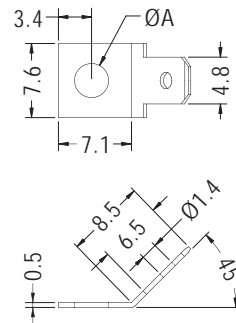
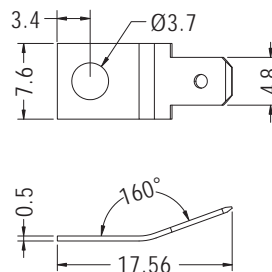

Part No.	Package
PC1V18706	1000

Part No.	A	Package
PC1V187	3.7	1000
PC1V18704	4.3	
PC1V18705	5.3	

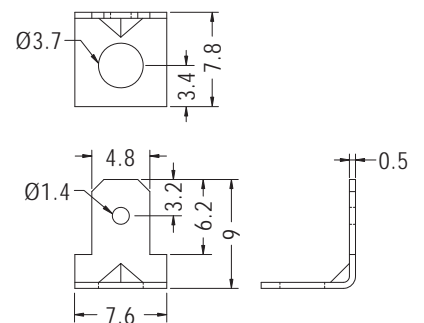
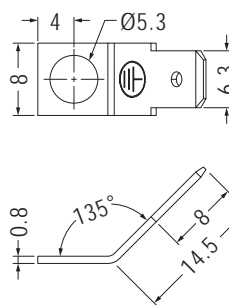
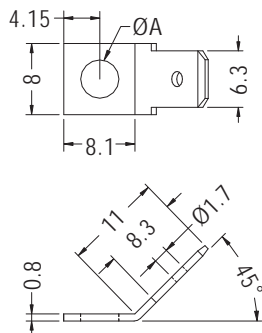

Part No.	A	Package
PC1L250	4.3	1000
PC1L25005	5.3	

- Material: Nickel Plated Steel

Part No.	Package
PC1L250-12	1000

Part No.	Package
PC1L187	1000

PC板端子 PCB TERMINAL

用途：可用螺絲鎖於PC板上，另一端插接端子。



- Material: Tin Plated Brass
- Unit: mm

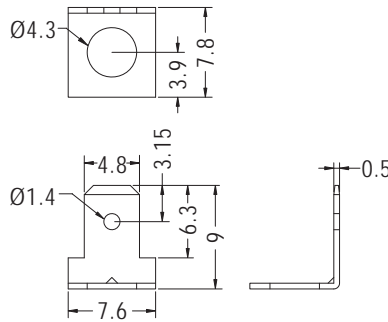

Part No.	Package
PC3L18704	1000

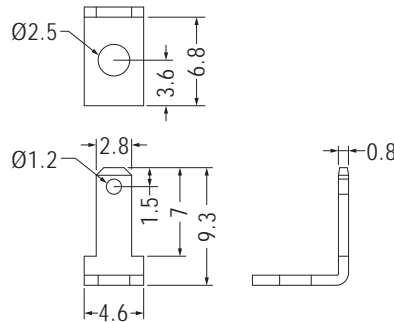

Part No.	Package
PC3L110028	1000

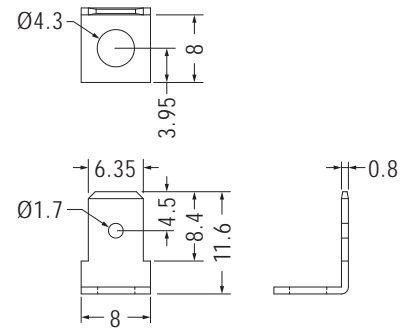

Part No.	Package
PC3L25004	1000

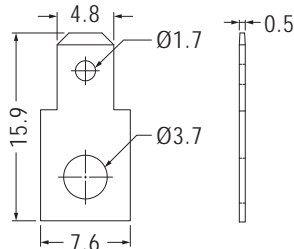

Part No.	Package
PC11187	1000

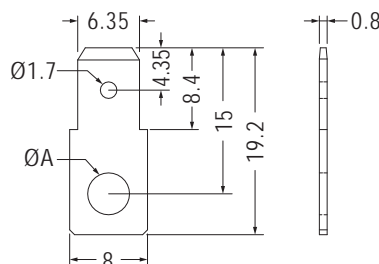

Part No.	A	Package
PC11250	4.3	1000
PC1125003	3.2	
PC1125035	3.5	
PC1125005	5.3	

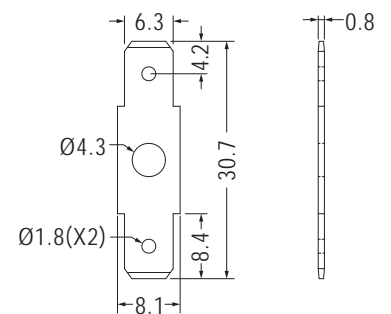

Part No.	Package
PC12250	1000

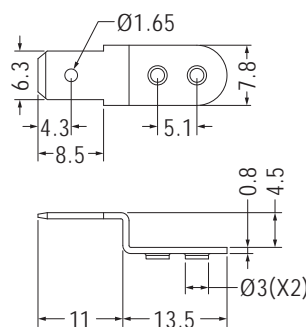

Part No.	Package
PC1L250-4	1000

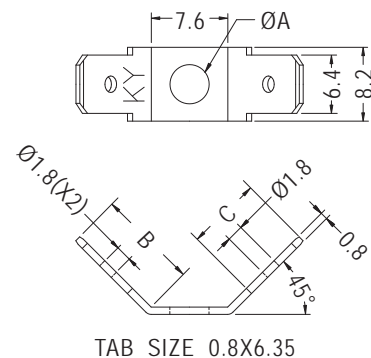

Part No.	A	B	C	Package
PC2L250	4.3	11.0	8.4	1000
PC2L25005	5.3	10.6	8.5	

PC板端子 PCB TERMINAL

用途：可用螺絲鎖於PC板上，另一端插接端子。

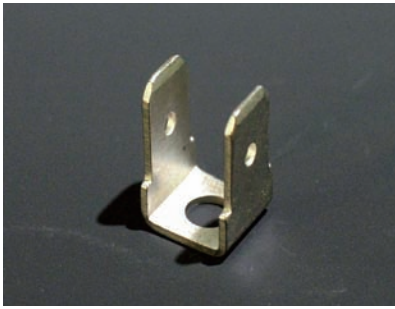

- Material: Tin Plated Brass
- Unit: mm

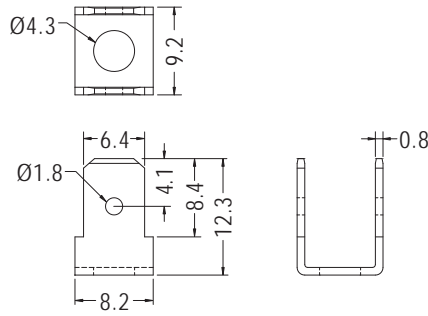

Part No.	Package
PC2L250-90	1000

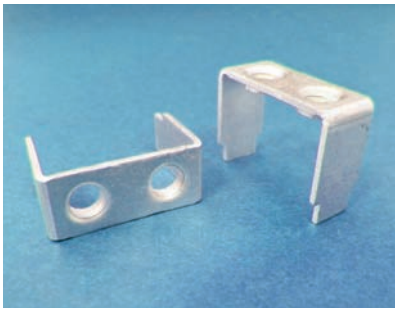

- Material: Tin Plated Phosphor Bronze
- Suggested Current: 25 Amps
- Unit: mm

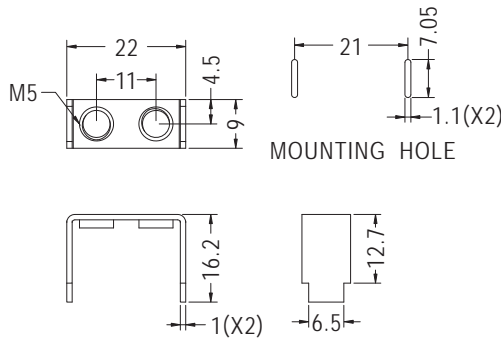

Part No.	Package
PCB-36	500

- Material: Tin Plated Brass
- Unit: mm

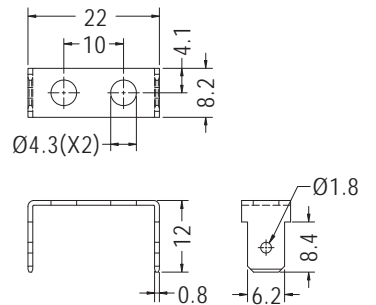

Part No.	Package
PCB-93	500

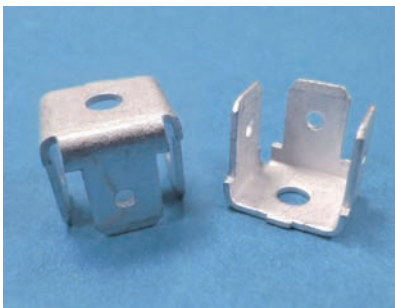

- Material: Tin Plated Brass
- Unit: mm

用途：PC板上之焊接電線端子，美觀、牢固，耐電流大，配合螺絲固定端子。

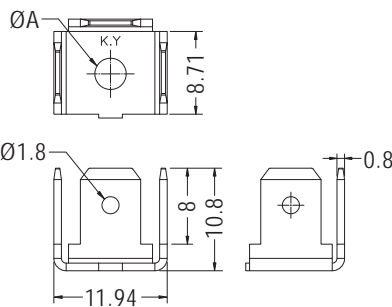

Part No.	A	Package
PC3L250-3	3.3	1000
PC3L250-4	4.3	

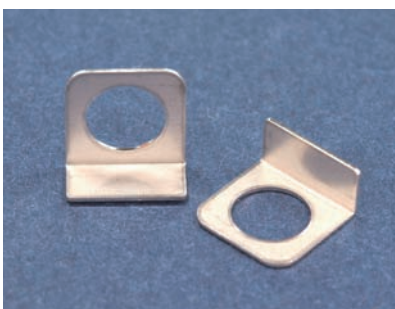

- Material: SUS
- Unit: mm

用途：PC板上之螺絲端子，美觀，牢固。

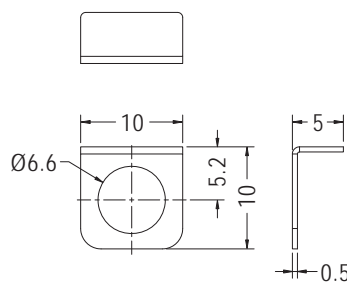

Part No.	Package
PCTL-2	1000

PC板端子 PCB TERMINAL

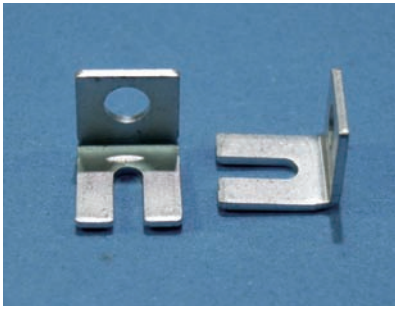

- Material: Tin Plated Brass
- Unit: mm

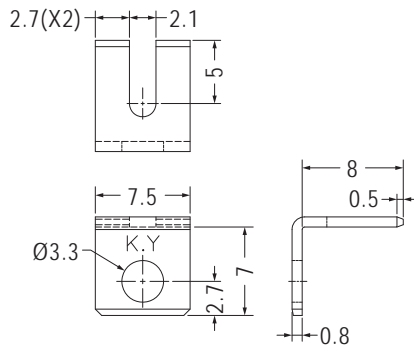

用途：PC板上之焊接電線端子，美觀、牢固，耐電流大，配合螺絲固定端子。

Part No.	Package
PCTL-3.5	1000

接地片 GROUND TERMINAL



- Material: Tin Plated Brass
- Unit: mm

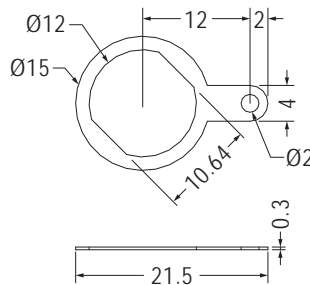

用途：用於電子、電腦儀器接地端點，一端焊於接地線，另一端用螺絲鎖於機殼。

Part No.	Package
GND-24	1000



- Material: Nickel Plated Brass
- Unit: mm

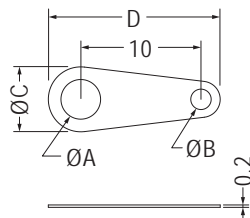

Part No.	A	B	C	D	Package
GND-1	3.2	1.6	5.5	14.3	2000
GND-3A	4.1	2.4	6.5	15.5	



- Material: Brass
- Unit: mm

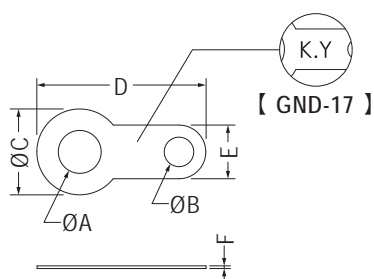

Part No.	A	B	C	D	E	F	Finish	Package
GND-2	3.2	2.1	6.4	12.6	4.0	0.25	Nickel Plated	2000
GND-3	4.3	2.0	8.0	17.7	4.6	0.3	Nickel Plated	
GND-4	5.2	2.1	9.9	19.6	5.1	0.3	Nickel Plated	1000
GND-5	8.3	1.9	10.0	15.0	4.0	0.3	Nickel Plated	
GND-6	9.7	2.0	13.0	21.5	4.0	0.4	Nickel Plated	2000
GND-10	6.3	2.1	10.0	19.9	5.1	0.3	Nickel Plated	
GND-11	9.0	2.0	13.0	30.0	4.0	0.3	Nickel Plated	1000
GND-17	4.2	1.6	6.8	12.9	3.2	0.4	Tin Plated	2000
GND-21	3.7	1.6	6.3	12.6	3.2	0.4	Tin Plated	
GND-41	3.2	1.5	4.5	12.6	3.0	0.25	Nickel Plated	2000
GND-42	2.2	1.5	4.5	12.6	3.0	0.25	Nickel Plated	

接地片 GROUND TERMINAL

用途：用於電子、電腦儀器接地端點，一端焊於接地線，另一端用螺絲鎖於機殼。

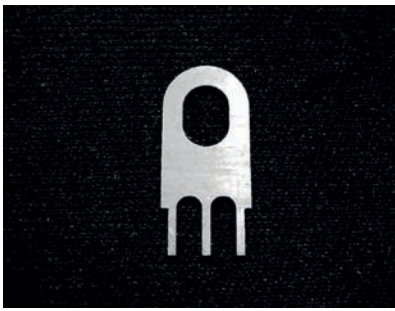

- Material: Tin Plated Brass
- Unit: mm

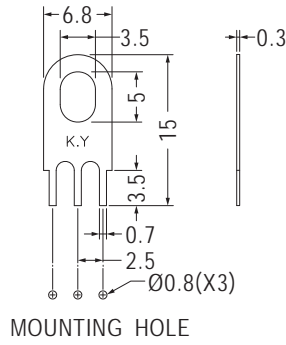

Part No.	Package
GND-34	1000



- Material: Tin Plated Brass
- Unit: mm

用途：用於電子、電腦儀器接地端點，一端焊於PC板上，再用螺絲固定，接地效果佳。

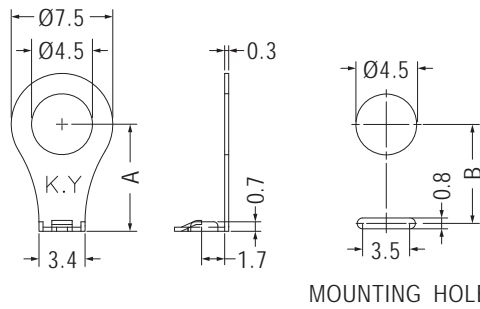

Part No.	A	B	Package
GND-32	7.9	7.6	1000
GND-51	7.6	7.3	



- Material: SPCC
- Finish: Tin Plated Over Brass Base
- Unit: mm

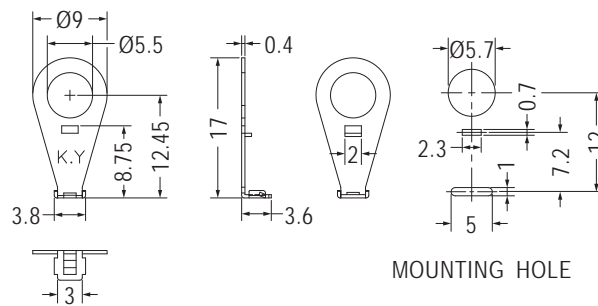

Part No.	Package
GND-96	1000



- Material: Phosphor Bronze With Nickel Plated
- Unit: mm

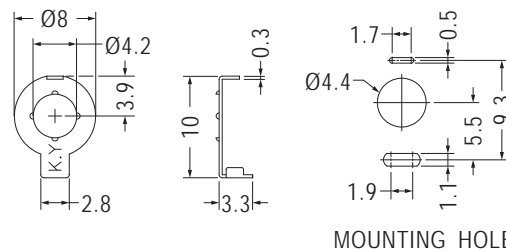

Part No.	Package
GND-7	1000



- Material: Tin Plated Phosphor Bronze
- Unit: mm

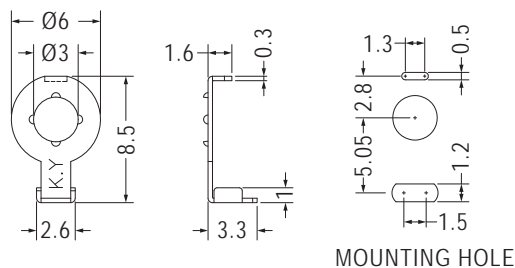

Part No.	Package
GND-103	1000

接地片 GROUND TERMINAL

用途：用於電子、電腦儀器接地端點，一端焊於PC板上，再用螺絲固定，接地效果佳。



- Material: Nickel Plated Brass
- Unit: mm

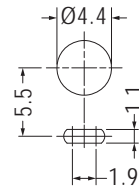
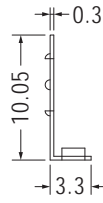
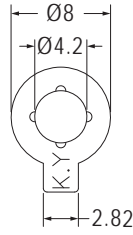

MOUNTING HOLE

Part No.	Package
GND-14	1000

- Material: Brass With Tin Plated/Nickel Plated
- Unit: mm

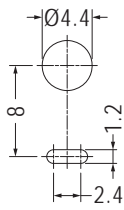
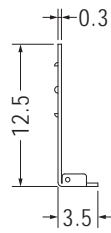
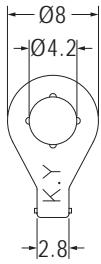

MOUNTING HOLE

Part No.	Package
GND-8	1000

- Material: Nickel Plated Phosphor Bronze
- Unit: mm

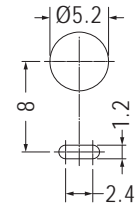
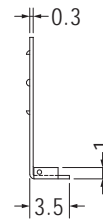
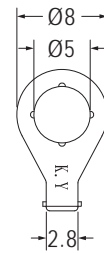

MOUNTING HOLE

Part No.	Package
GND-20	2000



- Material: Nickel Plated Brass
- Unit: mm

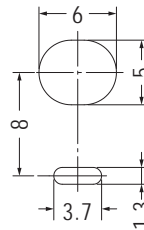
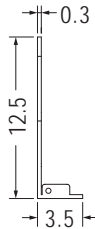
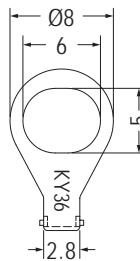

MOUNTING HOLE

Part No.	Package
GND-36	1000

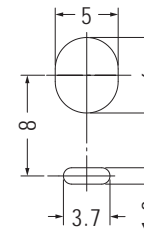
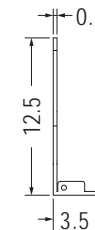
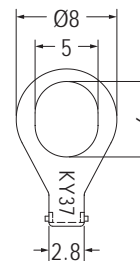

MOUNTING HOLE

Part No.	Package
GND-37	1000



- Material: Tin Plated Brass
- Unit: mm

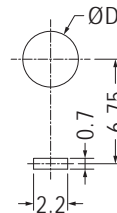
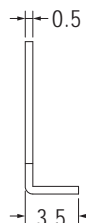
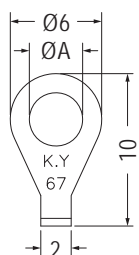

MOUNTING HOLE

Part No.	A	D	Package
GND-67	3.5	3.6	1000
GND-67(4.0)	4.0	4.1	

接地片 GROUND TERMINAL

用途：用於電子、電腦儀器接地端點，一端焊於PC板上，再用螺絲固定，接地效果佳。

- Material: Tin Plated Brass
- Unit: mm

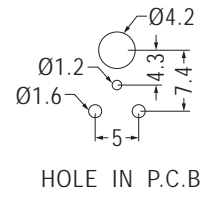
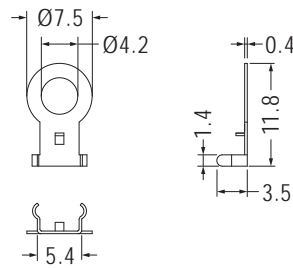

Part No.	Package
GND-13	1000

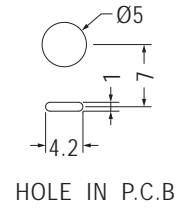
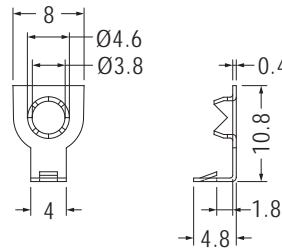

Part No.	Package
GND-12	1000

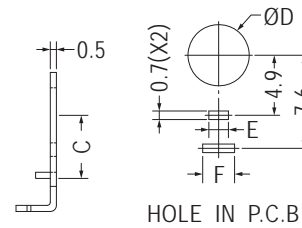
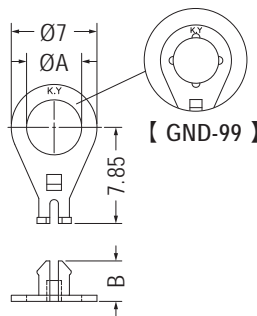

Part No.	A	B	C	D	E	F	Package
GND-15	3.5	4.6	5.1	4.0	1.5	2.7	2000
GND-35	4.5	4.6	5.1	4.5	1.5	2.7	
GND-39	4.5	3.3	5.15	5.0	1.6	2.6	1000
GND-99	4.5	3.3	5.15	5.0	1.6	2.6	

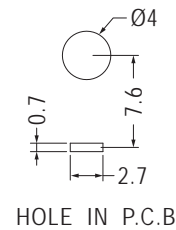
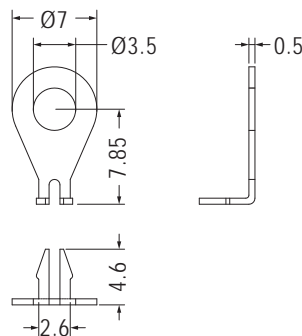

Part No.	Package
GND-23	1000

接地片 GROUND TERMINAL

用途：用於電子、電腦儀器接地端點，一端焊於PC板上，再用螺絲固定，接地效果佳。



- Material: Tin Plated SPTE
- Unit: mm

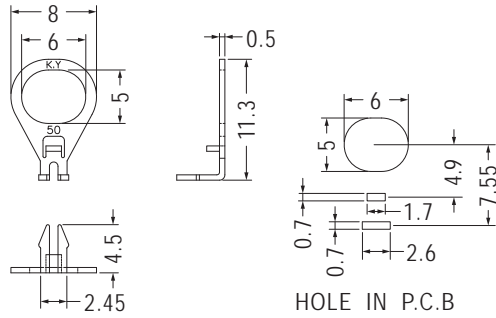

Part No.	Package
GND-50	1000

- Material: Tin Plated Brass
- Unit: mm

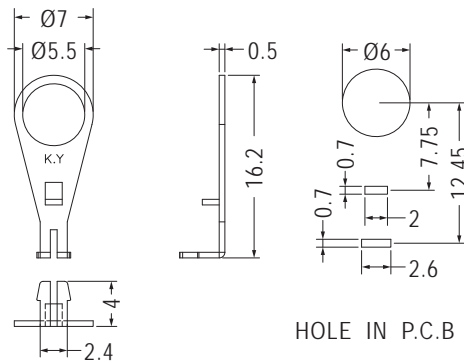

Part No.	Package
GND-55	1000



- Material: Tin Plated Phosphor Bronze
- Unit: mm

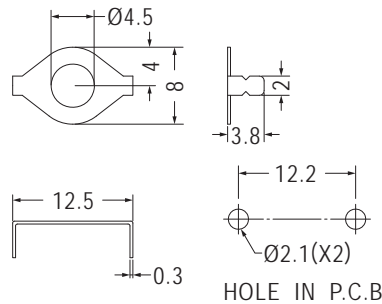

Part No.	Package
GND-44	1000

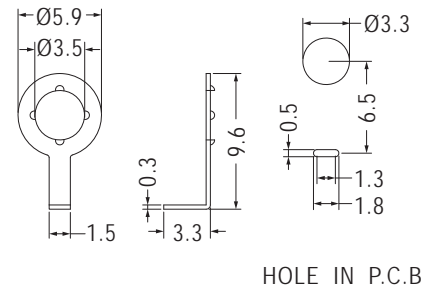

Part No.	Package
GND-49	1000

- Material: Phosphor Bronze With Nickel Plated
- Unit: mm

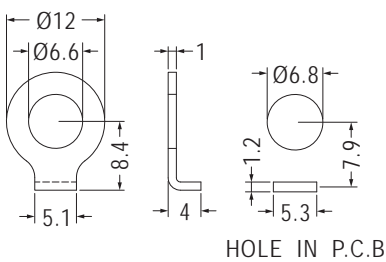

Part No.	Package
GND-52	1000

- Material: Tin Plated Brass
- Unit: mm

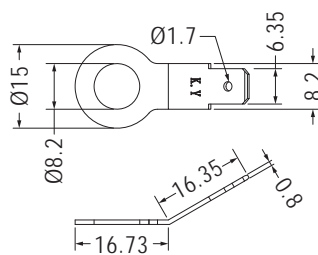

Part No.	Package
GND-54	1000

- Material: Tin Plated SPCC
- Unit: mm

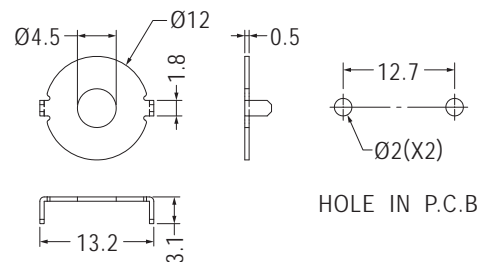

Part No.	Package
GND-56A	1000

接地片 GROUND TERMINAL



- Material: Tin Plated Phosphor Bronze
- Unit: mm

用途：用於電子、電腦儀器接地端點，一端焊於PC板上，再用螺絲固定，接地效果佳。

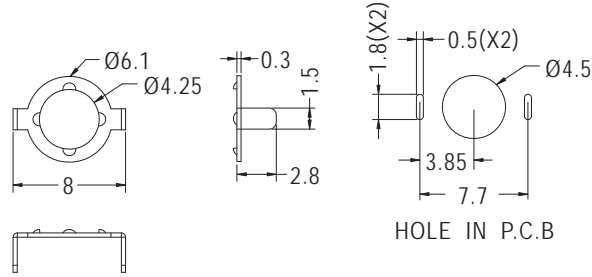

Part No.	Package
GND-74	1000



- Material: Tin Plated Brass
- Unit: mm

用途：用於電子、電腦儀器接地端點，一端焊於接地線，另一端用螺絲鎖於機殼。

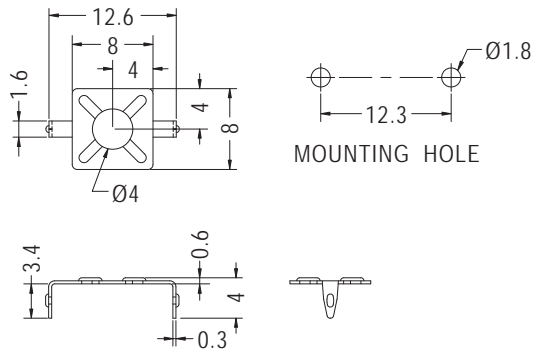

Part No.	Package
PCB-41A	1000

電晶體夾 TRANSISTOR CLIP

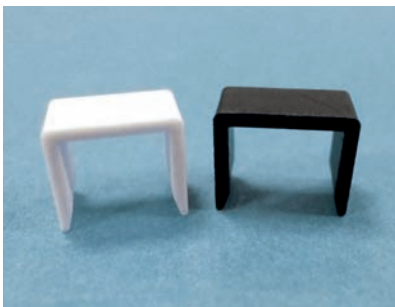

- Material: PBT (UL)
- Flame Class: 94V-0
- Color: Natural/Black
- Unit: mm

用途：用於零件之夾持。

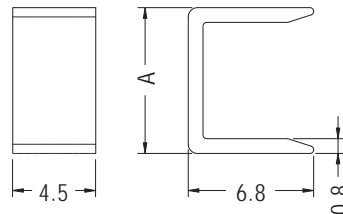

Part No.	A	Package
TRCMP-3	7.9	1000
TRCMP-4	8.6	

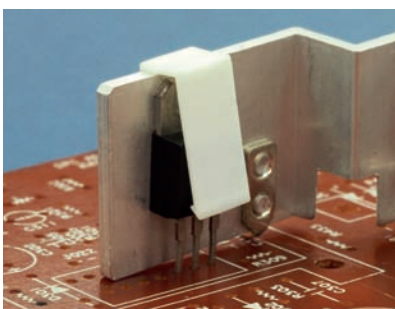

- Material: Nylon 66 (UL)/PBT (UL)
- Flame Class: 94V-0
- Color: Natural
- Unit: mm

用途：用於功率晶體及散熱片之固定，可配合灌膠使用。

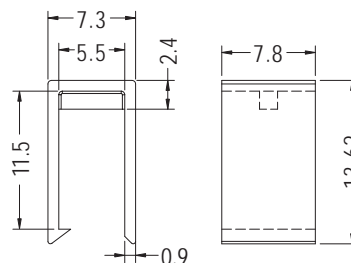

Part No.	Package
TRCMP-1	1000

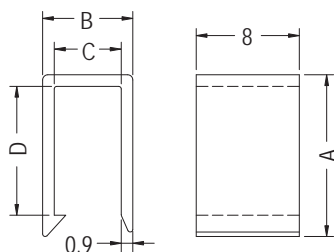

Part No.	A	B	C	D	Package
TRCMP-2	12.55	7.0	5.2	10.0	1000
TRCMP-5	12.6	7.5	5.7	10.0	
TRCMP-6	17.25	6.8	5.0	14.7	

電晶體固定彈片 TRANSISTOR CLAMP

用途：可將功率晶體快速固定於散熱片上，方便、耐高壓。



- Material: SUS
- Unit: mm

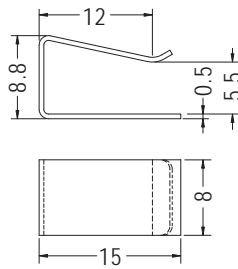

Part No.	Package
TRMC-7	1000

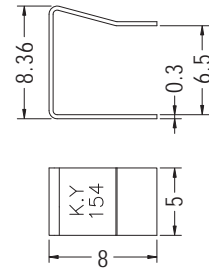

Part No.	Package
TRMC-154	1000

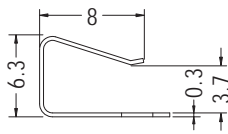

Part No.	Package
TRMC-20	1000

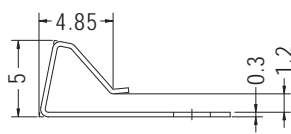

Part No.	Package
TRMC-23	1000

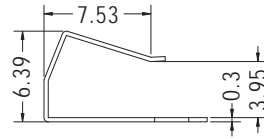

Part No.	Package
TRMC-26	1000

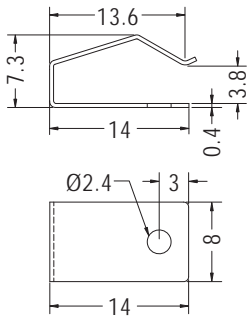

Part No.	Package
TRMC-34	1000

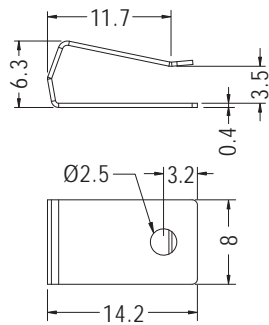

Part No.	Package
TRMC-40	1000

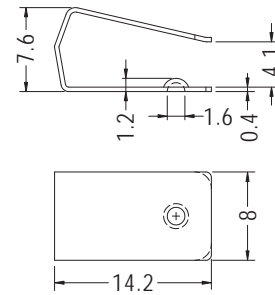

Part No.	Package
TRMC-35	1000

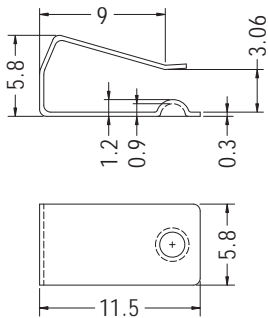

Part No.	Package
TRMC-49	1000

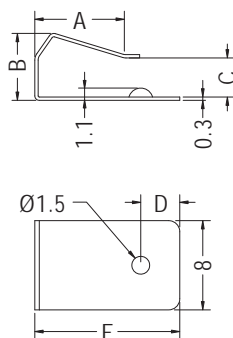

Part No.	A	B	C	D	E	Package
TRMC-76	8.0	6.1	3.5	3.5	13.0	1000
TRMC-77	6.9	7.5	4.5	4.0	11.0	
TRMC-78	6.9	8.5	5.8	4.0	11.0	

電晶體固定彈片 TRANSISTOR CLAMP

用途：可將功率晶體快速固定於散熱片上，方便、耐高壓。

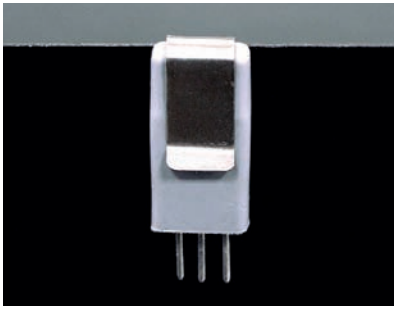

- Material: SUS
- Unit: mm

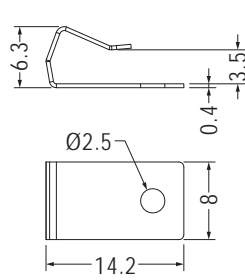

Part No.	Package
TRMC-59	1000

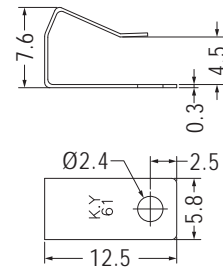

Part No.	Package
TRMC-61	1000

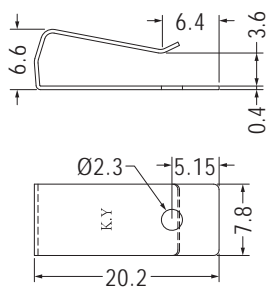

Part No.	Package
TRMC-9	1000

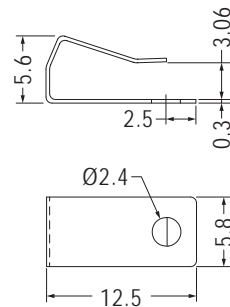

Part No.	Package
TRMC-17	1000

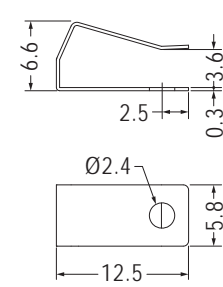

Part No.	Package
TRMC-30	1000

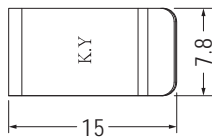

Part No.	Package
TRMC-1	1000

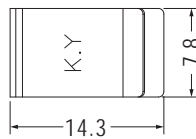

Part No.	Package
TRMC-2	1000

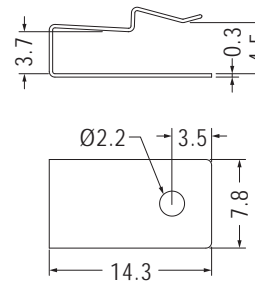

Part No.	Package
TRMC-5	1000

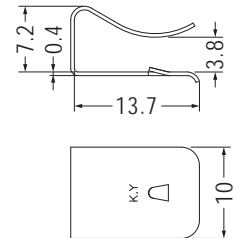

Part No.	Package
TRMC-6	1000

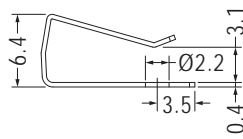
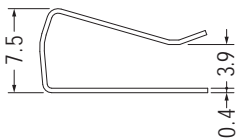

Part No.	Package
TRMC-122	1000

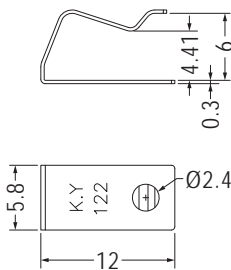

Part No.	A	B	Package
TRMC-123	7.1	5.3	1000
TRMC-124	7.22	5.35	

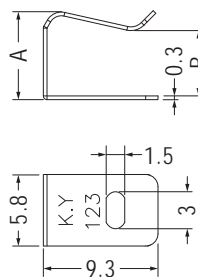

Part No.	Package
TRMC-141	1000

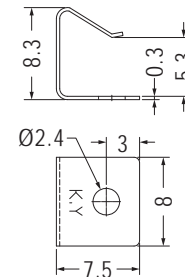

電晶體固定彈片 TRANSISTOR CLAMP

用途：可將功率晶體快速固定於散熱片上，方便、耐高壓。

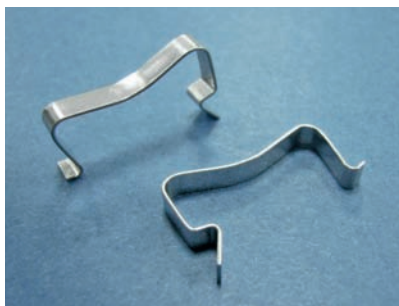

- Material: SUS
- Unit: mm

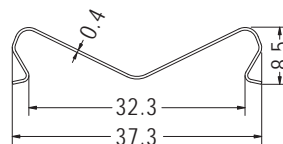
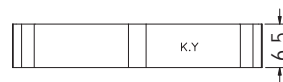
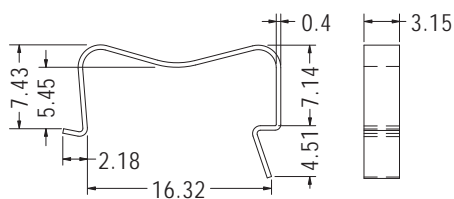

Part No.	Package
TRMC-8	1000

Part No.	Package
TRMC-121	1000

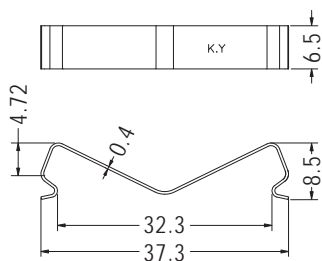

Part No.	Package
TRMC-126	1000

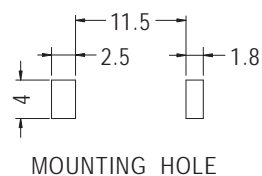
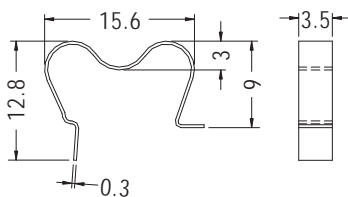

Part No.	Package
TO-220ST	1000



- Material: SUS
- Unit: mm

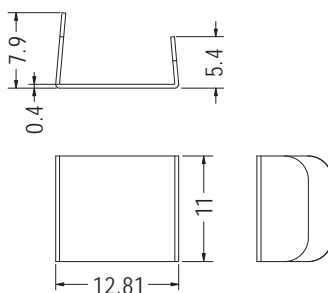

用途：可將功率晶體快速固定於散熱片上，方便。

Part No.	Package
TRMC-135	1000

彈片 CLAMP

用途：做為彈片。



- Material: Zinc Plated SK7
- Unit: mm

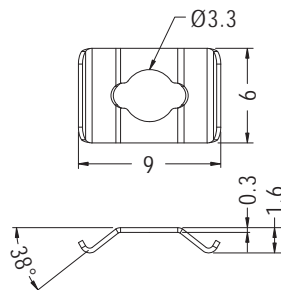

Part No.	Package
TRMC-68	1000

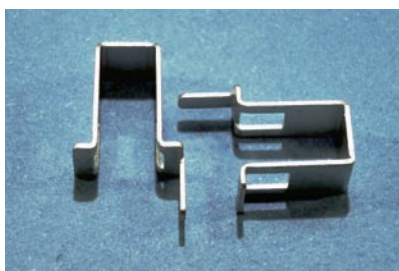

- Material: Tin Plated SPCC
- Unit: mm

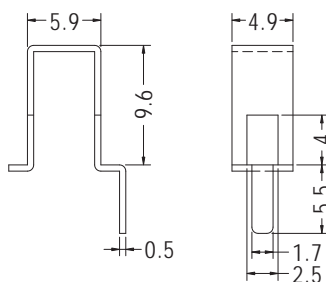

用途：做為導電彈片。

Part No.	Package
TRMC-10	1000

彈片 CLAMP

用途：做為彈片。



- Material: Tin Plated Phosphor Bronze
- Unit: mm

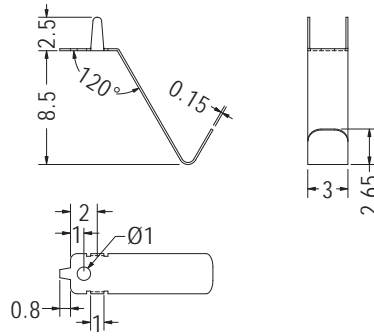

Part No.	Package
TRMC-11	2000

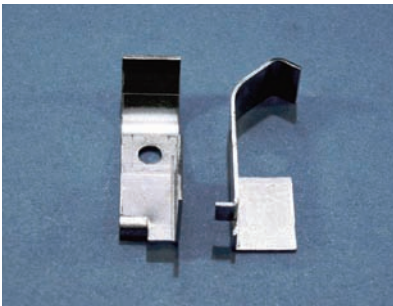

- Material: SUS
- Unit: mm

用途：做為彈片使用，彈性佳。

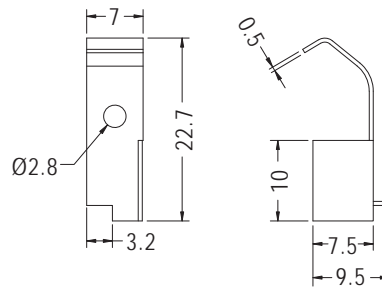

Part No.	Package
TRMC-12	1000



- Material: Tin Plated Brass
- Unit: mm

用途：做為插銷彈片。

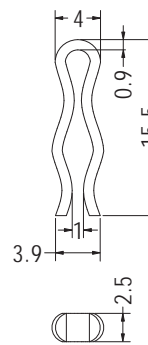

Part No.	Package
TRMC-53	1000

AAA電池彈片 POSITIVE AAA BATTERY CONTACT

用途：用於4號電池的彈片。

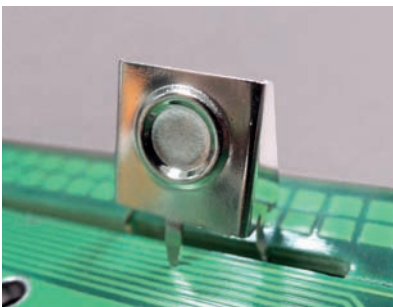

- Material: Nickel Plated Spring Steel
- Unit: mm

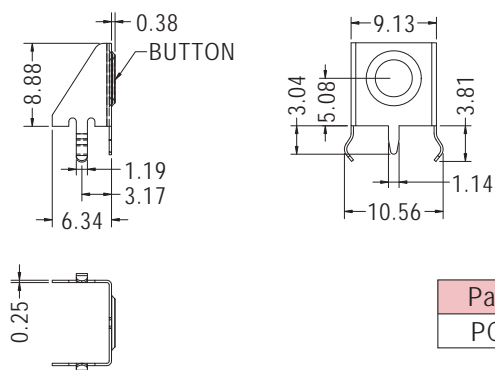

Part No.	Package
PCB-67	1000

AAA電池彈片 NEGATIVE AAA BATTERY CONTACT

用途：用於4號電池的彈片。

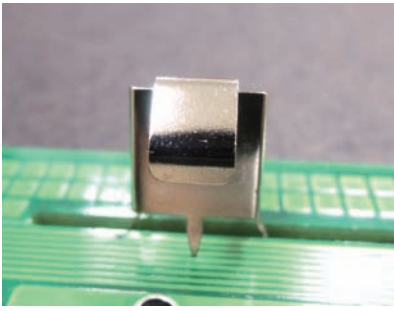

- Material: Nickel Plated Spring Steel
- Unit: mm

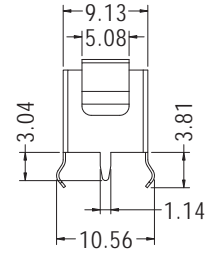
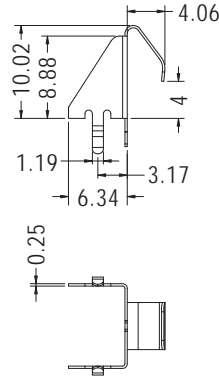

Part No.	Package
PCB-68	1000

阻尼齒輪 DAMPER GEAR

用途：用於音響或電腦外殼使開關門平順緩慢，增加質感。



- Gear Material: POM (UL) 94HB
- Body Material: PC (UL) 94V-2
- Color: Black
- Unit: mm

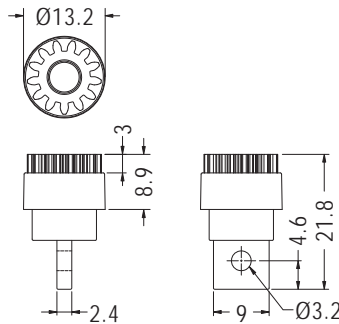

Part No.	Package
DP023A	500

Module	0.8
Pitch Circle Diameter	Ø10.4
Teeth Number	13
Pressure Angle	20°



- Gear Material: POM (UL) 94HB
- Body Material: ABS (UL) 94HB
- Color: Black
- Unit: mm

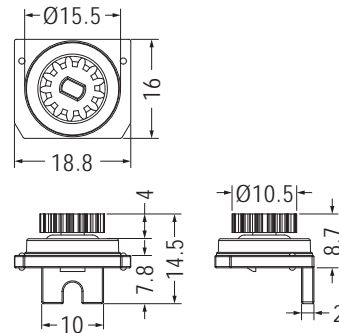

Part No.	Package
DP016A	500

Module	0.7
Pitch Circle Diameter	Ø9.1
Teeth Number	13
Pressure Angle	20°

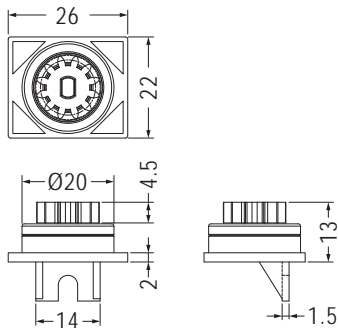

Part No.	Package
DP028A	500

Module	1.0
Pitch Circle Diameter	Ø12.0
Teeth Number	12
Pressure Angle	20°

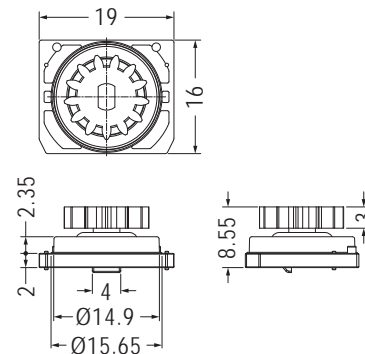

Part No.	Package
DP037A	500

Module	0.8
Pitch Circle Diameter	Ø10.4
Teeth Number	13
Pressure Angle	20°

阻尼齒輪 DAMPER GEAR

用途：用於音響或電腦外殼使開關門平順緩慢，增加質感。



- Gear Material: POM (UL) 94HB
- Body Material: ABS (UL) 94HB
- Color: Black
- Unit: mm

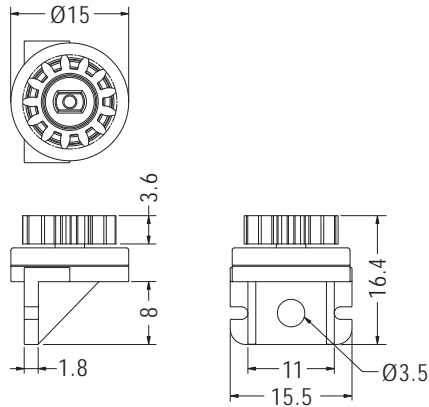

Part No.	Package
DP025A	500

Module	0.8
Pitch Circle Diameter	$\varnothing 10.4$
Teeth Number	13
Pressure Angle	14.5°

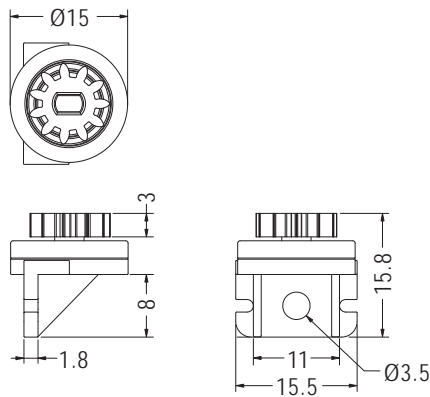

Part No.	Package
DP026A	500

Module	0.8
Pitch Circle Diameter	$\varnothing 8.8$
Teeth Number	11
Pressure Angle	20°

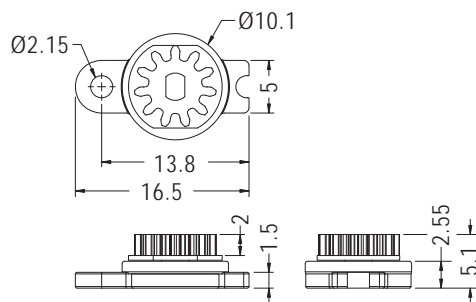

Part No.	Package
DP006A	500

Module	0.6
Pitch Circle Diameter	$\varnothing 6.6$
Teeth Number	11
Pressure Angle	20°

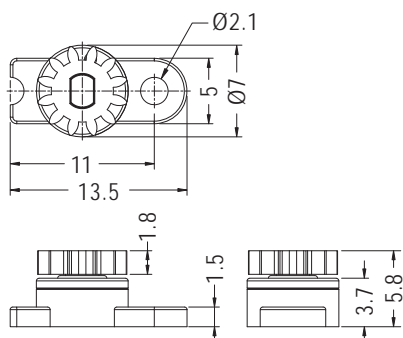

Part No.	Package
DP032A	500

Module	0.5
Pitch Circle Diameter	$\varnothing 6.0$
Teeth Number	12
Pressure Angle	20°

阻尼齒輪 DAMPER GEAR

用途：用於音響或電腦外殼使開關門平順緩慢，增加質感。



- Gear Material: POM (UL) 94HB
- Body Material: ABS (UL) 94HB
- Color: Black
- Unit: mm

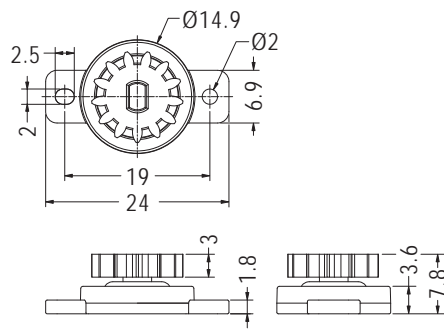

Part No.	Package
DP008A	500

Module	0.8
Pitch Circle Diameter	Ø10.4
Teeth Number	13
Pressure Angle	20°

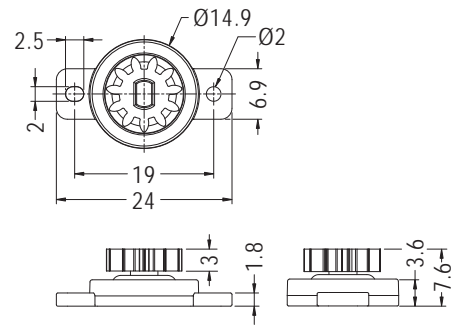

Part No.	Package
DP018A	500

Module	0.8
Pitch Circle Diameter	Ø8.8
Teeth Number	11
Pressure Angle	20°

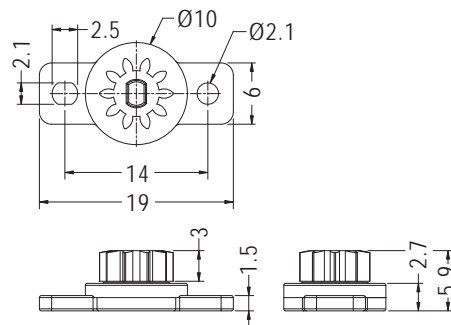

Part No.	Package
DP030A	500

Module	0.6
Pitch Circle Diameter	Ø6.0
Teeth Number	10
Pressure Angle	20°

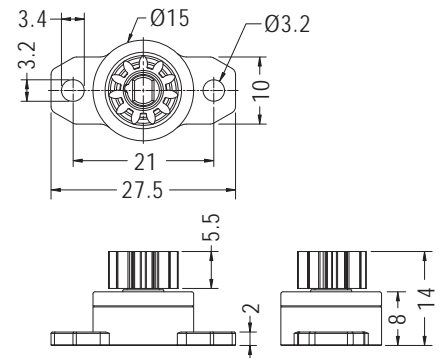

Part No.	Package
DP034A	500

Module	0.8
Pitch Circle Diameter	Ø8.8
Teeth Number	11
Pressure Angle	20°

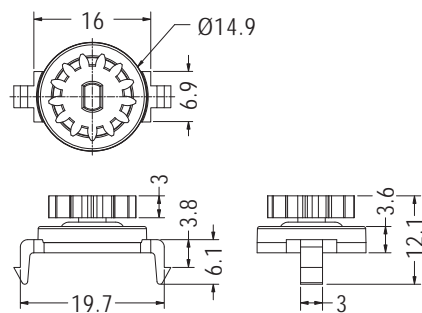

Part No.	Package
DP007A	500

Module	0.8
Pitch Circle Diameter	Ø10.4
Teeth Number	13
Pressure Angle	20°

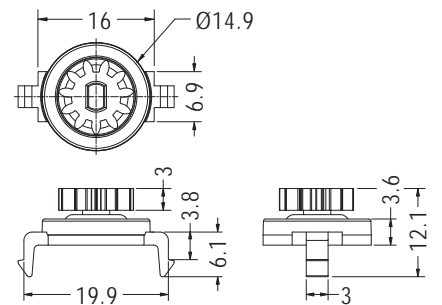

Part No.	Package
DP017A	500

Module	0.8
Pitch Circle Diameter	Ø8.8
Teeth Number	11
Pressure Angle	20°

阻尼齒輪 DAMPER GEAR

用途：用於音響或電腦外殼使開關門平順緩慢，增加質感。



- Gear Material: POM (UL) 94HB
- Body Material: ABS (UL) 94HB
- Color: Black
- Unit: mm

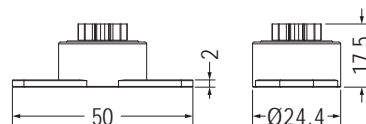
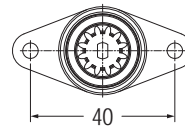
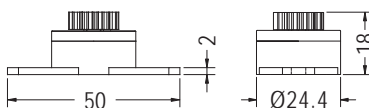
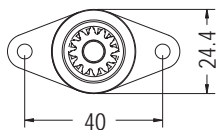

Part No.	Package
DP010A	500

Part No.	Package
DP036A	500

Module	1.0
Pitch Circle Diameter	Ø12.0
Teeth Number	12
Pressure Angle	20°

Module	1.0
Pitch Circle Diameter	Ø12.0
Teeth Number	12
Pressure Angle	20°



- Gear Material: POM (UL) 94HB
- Body Material: PC (UL) 94V-2
- Color: Black
- Unit: mm

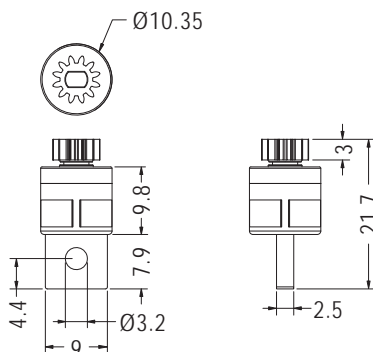

Part No.	Package
DP013A	500

Module	0.5
Pitch Circle Diameter	Ø6.0
Teeth Number	12
Pressure Angle	20°



- Gear Material: POM (UL) 94HB
- Body Material: PC (UL) 94V-2
- Gear Color: Black
- Body Color: Black/Transparent
- Unit: mm

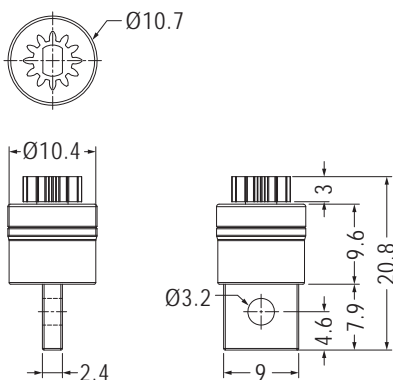

Part No.	Package
DP038A	500

Module	0.5
Pitch Circle Diameter	Ø6.0
Teeth Number	12
Pressure Angle	20°

塑膠齒輪 PLASTIC GEAR

用途：做為齒輪使用。

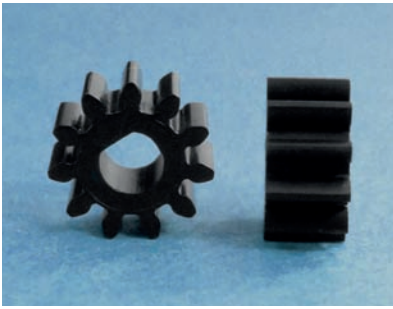

- Material: POM
- Color: Black
- Unit: mm

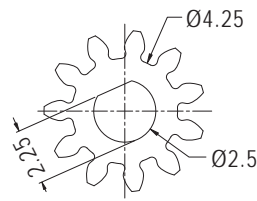

Part No.	Package
GRAP-1	1000

連接器 MINI JUMPER

用途：讓連接器兩個端點導通。



- Housing Material: PBT(UL)
- Flame Class: 94V-0
- Terminal Material: Brass
- Finish: Gold Plated
- Unit: mm

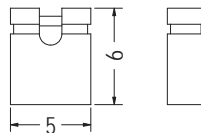

Part No.	Color	Package
MINI-1	Black	2000
MINI-1(R)	Red	
MINI-1(Y)	Yellow	
MINI-1(G)	Green	
MINI-1(BU)	Blue	



- Material: Nylon 66(UL)
- Flame Class: 94V-0
- Terminal Material: Brass
- Color: Black
- Unit: mm

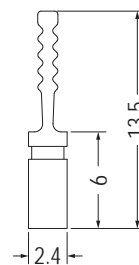
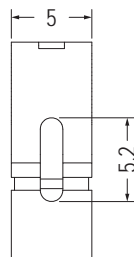

Part No.	Package
MINI-2	1000

	Part No.	Page		Part No.	Page		Part No.	Page		Part No.	Page		Part No.	Page
0	0.7-	1-100	3	3MY	10-1	A	ACB-	1-61	B	BSB632-15.9	1-66	B	BUB-217	7-74
	010406	5-5		3P-4	5-30		ACB-2.3	1-61		BSC632-	1-66		BUB-218	7-69
	012-958	7-36		3W-1	5-30		ACB-2.5	1-61		BSCB-	1-66		BUB-219I	7-73
	0609C	5-2		3WC-	4-120		ACB-3	1-61		BSCB-6	1-66		BUB-225	7-72
	0811	5-1	4-	1-103	ACBR-6		1-60	BSCB-20		1-66	BUB-231		7-69	
	0813	5-1	4-4.8	1-100	ACBW-6.8		1-67	BSCB4-		1-66	BUB-233		7-74	
	0813C	5-2	4.1-2.5	1-100	ACSR-7		7-67	BSCL-9.5		1-64	BUB-234		7-69	
1	1.2-	1-100	4.2-	1-100	ACSR-7		7-67	BSCM4-		1-67	BUB-235I		7-72	
	1.4-3	1-100	4.3-	1-100	ACSR-7		7-67	BSD632-		1-67	BUB-23I		7-70	
	1.6-	1-100	4.4-	1-100	ACSR-7		7-67	BSDM4-		1-67	BUB-243		7-69	
	1.7-11.3	1-100	4.5-	1-100	ACSR-7		7-67	BSE-2.2		1-71	BUB-245		7-70	
	10-6	1-101	4.7-3.5	1-100	ACSR-7		7-67	BSE-2.2L		1-71	BUC-2		7-68	
	12-19	1-101	4.9-	1-100	ACSR-7		7-67	BSS-		1-78	BW-	6-31		
	12.4-5	1-101	4K-4	5-30	ACSR-7		7-67	BUB-		7-68	BWC-	6-45		
	12.8-35	1-101	4N-4	5-30	ACSR-7		7-67	BUB-		7-70	C3	10-4		
	13-5	1-101	4WC-4	4-121	ACSR-7		7-67	BUB-		7-71	C4	10-4		
	1012-26	1-101	5-	1-100	ACSR-7		7-67	BUB-7I		7-70	C5	10-4		
	1014C	5-2	5-	1-101	ACSR-7		7-67	BUB-16.7		7-74	C8	10-4		
	1216	5-1	5.1-12.7	1-100	ACSR-7	7-67	BUB-25.5I	7-70		CABOX-	5-81			
	1216C	5-2	5.2-	1-100	ACSR-7	7-67	BUB-29	7-68		CAM-12	8-4			
1419C	5-2	5.3-2.8	1-100	ACSR-7	7-67	BUB-30	7-68	CAPH-10		6-66				
10459	5-25	5.4-122	1-100	ACSR-7	7-67	BUB-32	7-69	CAPH-18	6-67					
2	2-	1-101	5.5-4	1-100	AST-7.2	1-77	BUB-45	7-71	CAPJ-18	6-67				
	2-3-1.9	1-100	5.55-11.8	1-101	AST-7.2	1-77	BUB-45I	7-72	CAPL-3.5	6-67				
	2.05-3.5	1-100	5.7-	1-101	ASFF-1A	9-15	BUB-66	7-71	CAPR-10	7-51				
	2.1-2.1	1-100	5.8-	1-101	ASFF-1B	9-15	BUB-79	7-71	CAPX-6	7-42				
	2.2-	1-100	5N-4	5-30	ASID-	7-15	BUB-85I	7-72	CAV-1	7-93				
	2.3-	1-100	5P-4	5-30	ASID-	7-15	BUB-86I	7-75	CBCS-14	1-34				
	2.4-9.4	1-100	5WC-	4-121	ASR-	1-77	BUB-90	7-73	CBLSS-	1-37				
	2.5-	1-100	6-	1-101	ASS-	1-79	BUB-95	7-73	CBS-	1-38				
	2.6-	1-102	6-3.1-7.5	1-100	AST-7.2	1-77	BUB-96	7-69	CBSA-13	1-33				
	2.7-	1-100	6-13A	1-97	ASUS-	5-55	BUB-97	7-69	CBSB-45	1-38				
	2.73-2.3	1-100	6.2-	1-101	ATFF-1	8-12	BUB-124	7-73	CBSS-	1-37				
	2.8-3.8	1-100	6.3-	1-101	AWC-	4-22	BUB-126	7-69	CC-	4-113				
	2.95-8	1-100	6.35-	1-101	AWCA-1	4-23	BUB-127	7-71	CC-	4-114				
	20.5-9.5	1-101	6.4-	1-101	AWCB-1	4-24	BUB-130I	7-70	CCA-	4-116				
	29-16	1-101	6.5-3	1-101	AWD-	4-77	BUB-132	7-74	CCB-	4-116				
	2L-	4-105	6.8-5	1-101	AWE-	4-23	BUB-133	7-74	CCE-1	4-38				
	2P-1	5-29	6.9-12.7	1-101	AWK-	4-77	BUB-136	7-73	CCF-1	4-114				
	2P-4	5-30	6.432-6.4	1-100	AWKA-	4-77	BUB-138	7-73	CCHD-	4-106				
	2WCA-2	4-120	6N3-4	5-30	BASE-L5	6-71	BUB-139	7-74	CCM-1	4-110				
	3	3-	1-102	6N-4	5-30	BCB-	6-71	BUB-152	7-69	CCMA-	4-18			
		3-5.8	1-100	6P3-4	5-30	BCBA-	6-71	BUB-155	7-73	CCMB-	4-18			
3-25-6		1-100	6P-4	5-30	BCC-	6-72	BUB-159	7-72	CCMC-1	4-18				
3.1-		1-100	7-	1-101	BCC-18-20	6-72	BUB-161I	7-72	CCMD-1	4-18				
3.2-		1-100	7.5-	1-101	BCCA	6-72	BUB-171	7-74	CCME-1	4-110				
3.35-5		1-100	7N-2	5-30	BCCA-1210	6-72	BUB-172	7-73	CCMF-	4-109				
3.5-		1-103	7P-2	5-30	BCD-10.3	6-72	BUB-175L	7-71	CCMG-1	4-117				
3.5-5.5		1-100	8-16	1-101	BCG-250	8-26	BUB-177	7-74	CCMH-	4-17				
3.55-		1-100	8.2-5.5	1-101	BCG-450	8-26	BUB-179	7-71	CCMHA-6	4-17				
3.56-		1-100	8.2-80	1-101	BGCA-22	6-45	BUB-180	7-69	CCMI-1	4-75				
3.6-		1-100	8.4-5	1-101	BGCB-30	6-45	BUB-182	7-69	CCMJ-1	4-119				
3.7-		1-100	8.5-	1-101	BGCC-22	6-45	BUB-189	7-68	CCMK-	4-75				
3.8-		1-100	878008	10-1	BGCV-	6-45	BUB-194	7-69	CCML-1	4-75				
3.9-5.3		1-100	9-	1-101	BHP2-6	1-106	BUB-196	7-73	CCMT-2	4-110				
3.95-3.8		1-100	9-15	1-97	BNC-	7-14	BUB-202	7-69	CCMV-1	4-110				
312-3		5-1	9.1-7.5	1-101	BNCH-1	7-14	BUB-205	7-69	CCMW-	4-110				
375-4		5-1	9.25-4	1-101	BPLT-9	1-145	BUB-209	7-70	CCO-	4-115				
3MB	10-1	9.5-34	1-101	BPLT-13	1-145	BUB-211I	7-72	CCP-2	4-114					
3MR	10-1	A	ABSC-2318	6-85	BPLTA-3	7-67	BUB-213	7-70	CCU-	4-112				

Part No.	Page
CD-	4-115
CD-	4-116
CDEL-	5-19
CDEL-2	7-39
CDEL-3	7-39
CDK-	4-117
CDK-2	4-118
CDK-6	4-118
CDKW-	4-115
CDMCV-	7-18
CDV-	4-116
CE1	10-4
CE2	10-4
CE5	10-4
CE8	10-4
CFC-1	7-8
CFMG-1	4-45
CG-	8-23
CG-	8-25
CG-9A	8-21
CG-9AL	8-21
CG-9B	8-22
CG-9D	8-22
CG-10A	8-22
CG-15	8-24
CG-25	8-22
CG-26	8-22
CG-30	8-31
CG-38	8-23
CG-38L	8-23
CG-45	8-26
CG-50	8-23
CG-50S	8-23
CG-63	8-24
CG-77	8-24
CG-90S	8-23
CG-110	8-24
CG-120	8-25
CG-140	8-27
CG-153	8-24
CG-191	8-25
CG-218	8-25
CG-280	8-28
CG-300L	8-23
CG-450S	8-23
CG-XXXA	8-25
CGA-	8-27
CGA-63	8-27
CGA-76	8-27
CGA-89	8-27
CGA-102	8-27
CGA-140	8-28
CGB-	8-21
CGB-2	8-39
CGB-3.2	8-39
CGB-6	8-39
CGB-100L	8-21
CGBB-100	8-21
CGBC-89	8-21
CGC-1	8-37

Part No.	Page
CGC-43	8-23
CGDLA-57	8-29
CGDLA-102	8-26
CGDLA-102L	8-26
CGDLA-350	8-26
CGDLB-57	8-29
CGE-169	8-22
CGF-218	8-25
CGH-1	8-35
CGH-31	8-36
CGH-31L	8-36
CGH-37	8-37
CGH-37L	8-37
CGH-90	8-38
CGH-130	8-38
CGHA-65	8-37
CGHB-65	8-38
CGHB-90	8-38
CGHC-	8-36
CGHE-	8-36
CGHI-1	8-35
CGL-4	8-29
CGL-8	8-29
CGLA-	8-29
CGLA-10	8-29
CGLA-11	8-29
CGLC-8	8-29
CGLC-30	8-30
CGLC-32-1	8-30
CGLC-32-2	8-30
CGLC-50.8	8-30
CGLC-120	8-30
CGLC-120S	8-30
CGLC-153	8-30
CGLD-50	8-31
CGLE-18	1-94
CGLF-32	1-94
CGLG-47	8-31
CGLI-100	8-31
CGLJ-110	8-26
CGLM-1	8-32
CGLM-1N	8-32
CGLM-2	8-32
CGLM-113	8-32
CGLM-113-M2	8-32
CGLN-2	8-33
CGLN-2-M2	8-33
CGLN-3	8-33
CGLN-5	8-34
CGLN-6-M2	8-33
CGLN-9	8-32
CGLN-113	8-32
CGLN-113-M2	8-32
CGLP-3F-M2	8-34
CGLP-4F-M2	8-35
CGLP-5F-M2	8-34
CGLQ-153	8-30
CGQ-105	8-21
CGS-280	8-28
CH-	4-62

Part No.	Page
CH-1	4-90
CH-9	4-74
CH-12	4-74
CHA-	4-60
CHA-10	4-61
CHA-14	4-61
CHAA-	4-64
CHAB-	4-58
CHAC-	4-89
CHACA-1	4-89
CHACB-1	4-94
CHAD-1	4-61
CHAE-1	4-57
CHAF-3	4-64
CHAH-	4-63
CHAU-1	4-66
CHAV-1	4-57
CHAW-1	4-58
CHBA-	4-57
CHBB-	4-47
CHBB2-	4-47
CHBD-1	4-48
CHBE-1	4-47
CHC-	4-91
CHC-4	4-92
CHC-6	4-92
CHCA-1	4-93
CHCK-	4-88
CHCS-1	4-91
CHD	4-63
CHD-	4-63
CHD-19	4-64
CHE-	4-63
CHF-	4-62
CHH-	4-91
CHH-3	4-90
CHI-	4-87
CHJ-3	4-90
CHK-	4-87
CHKA-1	4-92
CHKC-1	4-93
CHKE-1	4-88
CHL-3	4-90
CHLB-1	4-93
CHM-	4-91
CHMK-	4-94
CHN-	4-76
CHNA-1	4-76
CHO-	4-20
CHP-	4-61
CHPA-1	4-61
CHPB-1	4-61
CHQ-	4-74
CHQC-1	4-74
CHOE-1	4-74
CHOF-1	4-74
CHR-11	4-61
CHS-	6-62
CHSA-	6-73
CHT-42	4-66

Part No.	Page
CHU-1	4-36
CHUA-	4-36
CHUB-1	4-36
CHUC-1	4-36
CHUE-1	4-37
CHUF-1	4-36
CHUK-1	4-111
CHUL-	4-37
CHV-59	4-66
CHW-	4-94
CHWA-2	4-88
CHWB-	4-12
CHWC-	4-11
CHWE-	4-93
CHWF-1	4-88
CHWG-1	4-37
CHWH-4.4	4-90
CHWK-1	4-88
CHWS-	4-88
CHWT-	4-90
CHX-1	4-61
CHY-1	4-55
CHZ-	4-92
CHZA-	4-92
CHZB-1	4-92
CHZC-	4-62
CJCV-	7-5
CJCV-6	7-6
CJCV-11	7-6
CKS-	4-76
CKSA-20-L	4-76
CL-	4-50
CLB-1	4-51
CLDK-1	6-70
CLE-1	4-50
CLE-3	4-51
CLF-	4-51
CLG-	4-51
CLH-6	4-118
CLI-	4-118
CLIA-3	4-117
CLM-7.5	4-123
CLS-	4-123
CLT-	4-122
CLT-7	4-123
CLT-9	4-123
CLT-16	4-123
CLU-1	4-119
CM-	4-107
CM-1	4-106
CM-18	4-106
CM-28S	4-106
CM-38	4-106
CMG-	4-44
CMKB-	4-65
CNPS8000	7-66
COC	6-58
COC8-5	2-5
COCA2.2-3	6-58
COCA3-0.6	6-57

Part No.	Page
COCA3.5-2.3	6-58
COCA4-0.6	6-57
COCE-1	6-58
COCF-1	6-57
COILC-21	6-64
COVER-	7-29
COVER-1	7-4
COVER-3	7-21
COVER-5	6-80
COVER-11	7-21
COVER-12	7-21
COVER-25	7-27
CP-15	8-19
CP-20	8-19
CP-25	8-19
CP-30	8-19
CP-35	8-20
CP-37	8-19
CP-38	8-19
CP-38L	8-19
CP-47	8-19
CP-50	8-19
CP-70	8-19
CP-72	8-20
CP-76	8-20
CP-77	8-20
CP-82	8-20
CP-84	8-20
CP-90	8-19
CPU140920A	6-74
CR	7-65
CRCAM-1	7-11
CRDCV-56	7-40
CRG	9-27
CRJ-11	7-15
CRJ-11-	7-15
CRJ-11-4I	7-16
CRJ-11-5	7-16
CRJ-11-7	7-16
CRJ-12	7-16
CRK5-15	7-65
CSATA-1	7-21
CSS-	1-78
CSSA-2	1-78
CTBX-1	5-82
CTBXA-1	5-82
CUS-5	1-74
CV145107	7-41
CVA-5	7-28
CVA-8	7-35
CVER-1	6-78
CVP-250	7-29
CVR-	7-34
CVR-1394	7-30
CVR-3012	7-41
CVR-3213	7-34
CVR-3413	7-34
CVR-3912	7-41
CVR-5312	7-41
CVR-6118	7-35

Part No.	Page	Part No.	Page	Part No.	Page	Part No.	Page	Part No.	Page						
C	CVR-6912	7-41	D	DP026A	10-46	E	EM-	4-50	E	ESS-19	1-71	F	FCTE-1	4-14	
	CVRB-1394	7-30		DP028A	10-45		EM-18-	6-37		ESS6-2.5	1-70		FCTF-1	4-14	
	CVRD-1394	7-30		DP030A	10-47		EM-19	6-87		ETS-	1-71		FCTG-1	4-14	
	CVSATA-	7-22		DP032A	10-46		EM-40-	6-37		ETSA-3.5	1-70		FCU-	4-3	
	CVSATAA-15	7-22		DP034A	10-47		EM-45	2-20		ETSB-6	1-71		FCUA-	4-7	
	CW-	6-70		DP036A	10-48		EM-45-	2-20		ETSS-6.5	1-71		FCUB-	4-6	
	CWCA-	6-71		DP037A	10-45		EM-51	6-33		EVA120430	9-25		FCUT-1	4-12	
	CWCD-	6-67		DP038A	10-48		EM-63	6-33		EVA862	9-25		FDT-	4-16	
	CWCK-10	6-69		DPC-	7-23		EM-303	7-6		F8040	6-78		FF-	9-1	
	CWK-1	4-4		DRAMCV-	7-40		EM-349	7-89		FANCA-	7-94		FF-15	9-2	
	CWL-	6-66		DRCB-18	1-11		EM-408	10-32		FANCS-3	7-94		FF-37	9-3	
	CWT-	6-65		DRLC-1I	7-41		EM-514H	4-123		FANCV-	7-94		FF-40F	9-2	
	CXP-	7-20		DT-1	7-83		EM-528	8-11		FANCV-5	7-95		FF-46F	9-2	
	DC-	4-87		DT-4	7-84		EM-535-	6-37		FBT-	4-130		FF-47F	9-2	
	DCB-	1-56		DT-10	7-86		EM-579	7-67		FC-19	4-1		FF-52F	9-2	
	DCB-16DL	1-56		DT-11	7-86		EM-580	6-29		FCA-	4-1		FF-55F	9-2	
	DCB-20DL	1-56		DT-12	7-85		EM-581	6-29		FCA-	4-2		FF-56	9-1	
	DCB-XXD	1-56		DT-14	7-86		EM-582	6-29		FCA-25	4-2		FF-57	9-1	
	DCBA-3.5	1-56		DT-16	7-84		EM-583	6-29		FCAB-	4-2		FF-59F	9-3	
	DCBA-8	1-56		DT-18	7-84		EM-646	4-123		FCAB-2	4-3		FF-60F	9-3	
	DCC-	1-50		DT-19	7-84		EM-682	1-91		FCAB-3	4-3		FF-62F	9-3	
	DCCA-4.3	1-51		DT-21	7-84		EM-710	7-89		FCAC-1	4-2		FFDA-10AY	9-15	
	DCCB-4.1	1-51		DT-22	7-85		EM-733	1-98		FCAM-1	4-5		FFDA-9AY	9-15	
	DCE-4	1-51		DT-42	7-87		EMAC-463	6-87		FCB-	4-5		FFG-1	9-7	
	DCVER-1	7-4		DT-43	7-88		EMC-1	7-6		FCC-	4-1		FFG-1A	9-7	
	DDMC-5.5	1-145		DT-45	7-87		EMC-40	8-3		FCCA-1	4-70		FFG-1G(RU)	9-7	
	DELT-19	1-93		DT-46	7-87		EMC-41	8-3		FCCB-1	4-70		FFG-1N	9-7	
	DELT-20	6-69		DT-47B	7-88		EMD-	6-33		FCCD-1	4-70		FFG-2	9-7	
	DELT-21	9-13		DT-48	7-86		EMD-10-	6-37		FCCT-12	4-71		FFG-2(S)	9-7	
	DELT-25	1-93		DT-49	7-87		E	EMD-14	6-35		FCD-	4-16		FFG-2A	9-7
	DELTA-3	1-98		DT-50	7-86			EMD-25	6-35		FCE-	4-7		FFG-2AS(RU)	9-7
	DGB-	5-21		DT-51	7-84			EMD-29	6-36		FCE-1	4-5		FFG-3	9-7
	DGB-25	5-22		DTA-	7-85			EMD-78-	6-37		FCE-2	4-5		FFG-30(S)	9-7
	DGB-26	5-22		DTA-42	7-87			EMD-118	6-35		FCE-3	4-5		FFG-3A	9-7
	DGB-40	5-22		DTB-1F	7-88			EMD-129	6-36		FCF-15	4-1		FFG-3AN	9-7
	DGBB-1	5-22		DTC-	7-25			EMD-131	6-36		FCG-15	4-71		FFH-30S(RU)	9-6
	D	DGBD-12	5-21	DTC-9MS	7-25			EMD-136	6-35		FCH-	4-4		FFK-1	9-6
		DGBE-1	5-21	DTC-20	7-26			EMD-140	6-36		FCH-29	4-4		FFK-1P	9-6
		DKCV-1	7-28	DTC-26	7-26			EMD-141	2-30		FCHA-1	4-4		FFK-2	9-6
		DKHR-	5-15	DTC-37M	7-26			EMD-147	6-36		FCI-	4-5		FFK-2P	9-6
		DL-	7-48	DTC-37ML	7-26			EMD-203	6-35		FCJ-30	4-15		FFK-3	9-6
		DLB-	7-51	DTC-50M	7-26			EMD-512	4-121		FCJ-40	4-3		FFK-3P	9-6
		DMSA-9	1-28	DTC-50S	7-26			EMF-6	4-75		FCJA-1	4-12		FFK-4P	9-6
		DMSB-5	1-24	DTC-68M	7-26			EML-	6-34		FCM-50	4-5		FFK-5(RU)	9-5
		DMSB-8	1-24	DTCB-1	7-26			EMP1-	2-42		FCL-33	4-6		FFK-6I	9-6
		DMSC-4.5	1-25	DTM-1	7-88			EMP1-XX-F	2-43		FCN-	4-1		FFP-30	9-5
		DMSP-	1-27	DTM-2	7-89			EMP2-	2-43		FCP-	4-29		FFP-40	9-5
		DMSPS-	1-27	DTTL-	7-81			EMP5-	2-42		FCPT-1	4-71		FFQ-	9-5
		DMSS-28	1-24	DTTL-4	7-82			EMP5-2-	2-43		FCS-	4-6		FFR-1	9-4
		DMSS-38	1-24	DTTL-5B	7-82			EMS-1	7-93		FCS-2	4-6		FFS-1	9-4
		DP006A	10-46	DTTL-7	7-82			EMU-5	7-83		FCS-31	4-7		FFS-2	9-4
		DP007A	10-47	DVDS-	1-74			ES-1	1-69		FCSA-	4-8		FFS-5	9-4
		DP008A	10-47	DVI-	7-27			ES-2	1-69		FCT-	4-13		FFT-	9-3
		DP010A	10-48	DVIC-	7-26			ESATA-7	7-22		FCT-7	4-14		FFT-15	9-4
		DP013A	10-48	DVT-1	6-62			ESS-1	1-70		FCT-9	4-14		FH-	6-75
		DP016A	10-45	E	EARC-3.5	7-37		ESS-2	1-70		FCT-9M	4-14		FH-13	6-75
		DP017A	10-47		EDC-	1-2		ESS-3	1-70		FCT-11	4-14		FH-17	6-75
		DP018A	10-47		EDGE-1	4-65		ESS-4	1-70		FCT-14	4-14		FHBBU-22	10-10
		DP023A	10-45		ELED-1	2-18		ESS-5	1-70		FCTB-	4-13		FHC-	7-39
		DP025A	10-46		ELH2-27	2-17		ESS-7.6	1-70		FCTC-	4-15		FHC-5	6-75

Part No.	Page
FHCA-1	7-39
FHCV-52	7-38
FIXE-1	5-17
FR-190	8-26
FR-250	8-26
FR-1300	8-28
FR2515N	7-42
FSB-	4-130
FSL-25	1-78
FSP-	7-75
FSP-9	7-76
FSS-	1-78
FSSA-15	1-78
FUA-1	10-12
FUC-	10-11
FUC-01	10-11
FUC-02	10-11
FUC-5A	10-12
FUC-09	10-11
FUC-17A	10-11
FUG-	6-22
FUSCV-1	10-10
FUSCV-2	10-10
FUSCV-3	10-10
FUSCV-4	10-10
FUSCV-6F	10-12
FUSCV-7F	10-12
FUSCV-8F	10-12
FUSCV-10	10-10
FUSCV-12F	10-12
FUSE-	6-75
FUSE-5	7-38
FUSE-6	7-38
FUSEA-1	6-75
FUSEC-1	10-12
FWAS-	4-22
FWC-	4-22
FWD-1	4-23
FWK-	4-78
FWKA-1	4-78
FWS-	4-22
FWT-	4-76
FWU-	4-22
GDBB-1	5-22
GDBB-2	5-22
GDFC-	7-37
GDFC-18N	7-38
GDFC-39	7-38
GDFC-42	7-38
GDFC-51	7-38
GDFC-53	7-38
GL-4	9-15
GLIN-10	6-27
GM-	5-6
GM-	5-7
GM-25	5-14
GM-26	5-14
GM-27	5-14
GM-28	5-14
GM-31	5-14

Part No.	Page
GM-32	5-14
GM-33	5-14
GM-34	5-14
GM-92	5-8
GM-131	5-10
GM-140	5-8
GM-158	5-8
GND-	10-35
GND-1	10-35
GND-3A	10-35
GND-7	10-36
GND-8	10-37
GND-12	10-38
GND-13	10-38
GND-14	10-37
GND-15	10-38
GND-20	10-37
GND-23	10-38
GND-24	10-35
GND-27	6-16
GND-32	10-36
GND-34	10-36
GND-35	10-38
GND-36	10-37
GND-37	10-37
GND-39	10-38
GND-44	10-39
GND-48	6-16
GND-49	10-39
GND-50	10-39
GND-51	10-36
GND-52	10-39
GND-54	10-39
GND-55	10-39
GND-56A	10-39
GND-67	10-37
GND-67(4.0)	10-37
GND-74	10-40
GND-75	6-16
GND-96	10-36
GND-99	10-38
GND-103	10-36
GPE2-24	8-15
GPE2-30	8-15
GPE2.6-6	8-15
GPE3-	8-15
GPE4-8	8-16
GPE4-8L	8-16
GPE4-12-1	8-16
GPE4-12L	8-16
GPE4-13.5	8-17
GPE4-42	8-17
GPE5-20	8-17
GPE8-21	8-16
GPE8-32	8-16
GPE44-1	8-17
GPE632-5	8-18
GPE632-6	8-17
GPE632-9	8-18
GPEA3-6BN	8-16

Part No.	Page
GPEA3-8BN	8-16
GPED3-6	8-16
GPEE3-3.5	8-15
GPM3-20	8-14
GPM4-20	8-14
GPM632-20	8-14
GPR3-5.5	8-18
GPR632-6	8-18
GRAP-1	10-49
GSS-	1-77
GT-	5-44
GTB-	5-51
GTBA-	5-51
GTP-	5-49
GULY-1AB-XXF	4-123
GULY-1CDE-XXF	4-128
GULY-2AB-XXF	4-124
GULY-3AB-XXF	4-124
GULY-3CDE-XXF	4-128
GULY-3FG-XXF	4-124
GULY-3HI-XXCF	4-127
GULY-3JK-XXCF	4-128
GULY-5AB-XXF	4-125
GULY-6AB-XXF	4-125
GULY-7AB-XXF	4-125
GULY-8AB-XXF	4-126
GULY-9AB-XXF	4-126
GULY-10-XXF	4-129
GULY-11-XXF	4-129
GULY-13AB-XXF	4-126
GULY-15AB-XXF	4-127
GULY-19-XXF	4-129
GULY-29AB-XXF	4-127
HAND-	5-64
HAND-1	5-61
HAND-2	5-61
HAND-7	5-61
HAND-10	5-65
HAND-12	5-61
HAND-13	5-61
HAND-14	5-62
HAND-23	5-62
HAND-26B	5-63
HAND-29	5-66
HAND-30	5-66
HAND-31	5-66
HAND-40	5-63
HAND-50	5-65
HAND-51	5-65
HAND-54	5-65
HAND-55	5-65
HAND-65	5-61
HAND-70	5-63
HAND-71	5-66
HAND-73	5-63
HAND-74	5-65
HAND-75	5-62
HAND-79	5-65
HAND-80-1	5-65
HAND-82	5-65

Part No.	Page
HAND-84	5-66
HAND-99	5-65
HANDN26A	5-63
HANE-	5-74
HANE-21	5-72
HANE-22	5-78
HANE-23	5-75
HANE-24	5-73
HANE-26	5-76
HANE-27	5-77
HANE-30	5-79
HANE-34	5-78
HANE-35	5-72
HANE-37	5-75
HANE-38	5-76
HANE-40	5-73
HANE-41	5-78
HANE-46	5-78
HANE-49	5-76
HANE-53	5-79
HANE-58	5-77
HANE-59	5-72
HANE-63	7-38
HANE-64	5-80
HANE-67	5-80
HANE-72	5-77
HANE-74	5-76
HANE-75	5-75
HANE-76	5-78
HANE-77	5-73
HANE-86	5-79
HANE-97	5-76
HANE-98	5-77
HANE-103	5-79
HANE-104	5-80
HANE-108	5-78
HANE-111	5-75
HANE18	5-73
HANE29	5-73
HANI-	5-71
HANT-	5-80
HANU-	5-68
HANU-27U	5-67
HANU-30PN	5-68
HANU-32	5-68
HANU-34	5-67
HANU-71	5-67
HANU-73	5-67
HANU-80	5-70
HANU-82	5-67
HANU-83	5-66
HANU-92	5-64
HANU-102	5-70
HANU-103	5-70
HANU-108	5-69
HANU-114	5-69
HANU-117	5-70
HANU-137	5-69
HANU-138	5-67
HANU-139	5-67

Part No.	Page
HANU-141	5-69
HANU-142	5-69
HANUL-	5-71
HASW3-	8-14
HASW4-	8-14
HASW5-	8-14
HDMIC-	7-24
HDMIC-3	7-25
HDMIC-4	7-25
HDMIT-1	7-25
HFCC-12	4-72
HFCD-29	4-72
HLCS-	1-43
HLS-	6-46
HP-	1-108
HP2050	1-111
HP2-	1-107
HP2.5-	1-107
HP4-	1-110
HP6-25	1-110
HP44L-	1-112
HP48-20	1-113
HP48-32	1-113
HP256-16	1-111
HP440-7.9S	1-111
HP440-9.5	1-111
HP440-15.9S	1-111
HP440-18	1-111
HP632-	1-112
HP632-64	1-112
HP832-6.35	1-113
HP832-19.1	1-113
HP832-25.4	1-113
HPA3-22.6	1-109
HPB2.5-10	1-120
HPC-11.9	1-113
HPC-15	1-113
HPC-19	1-113
HPC-21	1-113
HPC-30	1-113
HPC-45	1-113
HPC-73	1-114
HPC4-	1-114
HPC44-21	1-114
HPCA-21	1-114
HPH-	1-108
HPH-34	1-109
HPI3-	1-124
HPI4-	1-124
HPIA4-2	1-124
HPIB4-18.5	1-124
HPID4-14	1-124
HPIE4-3	1-124
HPL-30	1-109
HPL-40	1-109
HPL-100	1-109
HPL4-37	1-110
HPP3-25	1-109
HPP3-9	1-109
HPP3-9.5	1-109

Part No.		Page
HPP4-4.5		1-109
HPP10-64		1-113
HPP25-14.5		1-107
HPP25-20		1-107
HPP440-6.35		1-111
HPP440-11.2		1-111
HPP440-17.4		1-111
HPP632-14		1-112
HPP632-51		1-112
HPR-8		1-109
HPR-20		1-109
HPR3-7		1-109
HPR3-11		1-109
HPR3-22		1-109
HPR3-30		1-109
HPR4-10		1-110
HPR4-15		1-110
HPR4-70L		1-110
HPR5-25		1-110
HPR5-45		1-110
HPS-		1-108
HPS2-		1-106
HPS2.5-11		1-107
HPS2.5-16.5		1-107
HPS2.6-		1-108
HPS4-		1-110
HPS632-12		1-112
HPS632-19.1		1-112
HSR-		7-77
HSR-		7-78
HSR-1		7-79
HSR-2		7-79
HSR-8A		7-58
HSR-36		7-79
HSR-58		7-79
HSR-74-201		7-79
HSR-90		7-79
HSR-103		7-78
HSR-109		7-79
HSRA-1		7-58
HSRD-2		7-79
HU-		6-76
HW2839		1-92
ICV-		6-32
IMN-1		4-35
INTEC-1		8-39
IPOD-		7-8
IPWC-		7-9
IRCV-1		2-35
IRCV-2		2-35
ISS-		1-77
JETM-		4-44
JKCV-		7-13
JPC-1		6-62
JSS-		1-79
JUMP-10H		10-9
JUMP-21		10-8
JUMP-26		10-8
JUMP-34		10-8
JYCE-1		1-94

Part No.		Page
J	JYCE-2	1-94
	KE3.5-2	1-97
	KE4.1-8	1-97
	KEML-4	1-88
	KEML-10	1-88
	KEML-12	1-88
	KEMS-11.3	1-88
	KES-15	1-84
	KESS-19	1-89
	KG-	5-83
	KG-016N-	5-83
	KG-XXXN	5-83
	KGA13-	5-82
	KGB	5-33
	KGC-013-	5-82
	KGC-025-8	5-82
	KL-	4-104
	KLB-1	4-104
	KLC-1	4-104
	KLCBL-	1-42
	KLCBM-	1-42
	KLCBS-	1-42
	KLF-11	4-104
	KLH-330	3-19
	KLH-331	3-19
	KLH-340	3-20
	KLH-341	3-20
	KLH-342	3-20
	KLR-1	4-104
	KLS-1	4-104
K	KMCC-	4-112
	KPGB	5-33
	KPS-	7-10
	KPS-4	7-11
	KPS-9	7-11
	KPS-12	7-12
	KPS-13	7-13
	KPS-15	7-13
	KPS-18	7-13
	KPS-19	7-13
	KPS-20	7-9
	KPS-21	7-9
	KPS-24	7-9
	KPS-29	7-12
	KPS-31	7-12
	KPS-32	7-4
	KPS-36	5-24
	KPS-37	7-23
	KPS-39	7-4
	KPS-42	7-29
	KPS-46	7-12
	KPSA-	7-11
	KS079132	6-77
	KSC256-8.4F	8-12
	KSK	6-77
	KSM-1A	8-12
	KSM-1B	8-12
	KSM4-5M	8-12
	KSM4-6F	8-12
	KST-	5-84

Part No.		Page
	KTCC-	4-112
	KVD-05	1-21
	KVD-10	1-21
	KVLM3-	1-59
	KVLM4-10	1-59
	KVLM4-10	1-58
	KVM-	7-7
	KWA3-0.7	6-55
	KWH2-	1-104
	KWH3-	1-104
	KWH3.5-	1-105
	KWH4-	1-105
	KWH5-	1-105
	KWH6-3.2	1-105
	KWH440-	1-106
K	KWS	6-55
	KWS-	6-56
	KWS-2.6	6-55
	KWS-4.2-0.6	6-56
	KWS-6	6-56
	KWS2-	6-54
	KWS4-4	6-57
	KWS5-1.6	6-55
	KWS832-0.8	6-56
	KWSA-5	6-57
	KWSB2.5-2.2	6-54
	KWSP	6-54
	KYCB-129	5-47
	KYPC-40	6-68
	KYST-	5-84
	KYWS-3	6-55
	LAS-	1-47
	LASA-9.5	1-47
	LASB-3.7	1-46
	LASD-8.3	1-46
	LASE-	1-47
	LASF-18	1-48
	LASH-22	1-47
	LASJ-	1-47
	LASK-4	1-96
	LASK-5	1-96
	LASK-6	1-96
	LASL-4.8	1-47
	LASY-	1-47
L	LBS-	1-46
	LC3-1	2-33
	LC3-2	2-35
	LC3-6	2-33
	LC3-7	2-35
	LC3-8	2-34
	LC3-12	2-35
	LC3-13	2-33
	LC3-14	2-34
	LC3-14L	2-34
	LC3-XT	2-33
	LC5-1	2-33
	LC5-1T	2-33
	LC5-2	2-34
	LC5-2T	2-33
	LC5-3	2-34

Part No.		Page
	LC5-4	2-34
	LC5-5	2-34
	LC5-6	2-34
	LC5-7	2-35
	LC5-8	2-35
	LC5-9	2-34
	LCA-	1-37
	LCAB-12	1-40
	LCAB-14	1-40
	LCB-	1-38
	LCBA-5.6	1-42
	LCBA-7.6	1-42
	LCBB-	1-39
	LCBC-8	1-42
	LCBD-12.7	1-36
	LCBJ-9	1-35
	LCBL-8	1-89
	LCBM-	1-31
	LCBM-19L	1-31
	LCBS-	1-39
	LCBSA-20L	1-38
	LCBSA-28.5	1-38
	LCBT-	1-41
	LCC-	1-31
L	LCD-	1-34
	LCDCM-1	4-119
	LCDS3-	1-45
	LCDS4-	1-46
	LCEO-	1-36
	LCF-	1-34
	LCFB-8	1-35
	LCFO-	1-34
	LCG-	1-41
	LCGA-14	1-33
	LCGA-14S	1-33
	LCGB-17.5	1-41
	LCH-	1-37
	LCH-XXS	1-37
	LCH-	1-30
	LCIA-3.5	1-30
	LCJ-	1-29
	LCK-1	1-30
	LCL-3.2	1-38
	LCMA-	1-40
	LCMB-8	1-20
	LCMC-7	1-20
	LCMD-	1-40
	LCMM-	1-87
	LCMM-4	1-87
	LCO-	1-35
	LCOA-28.8	1-33
	LCP-	1-44
	LCPA-8.2	1-44
	LCPD-6.35	1-44

Part No.		Page
	LCPD-9.5	1-44
	LCPL-6.4	1-32
	LCPLB-11	1-32
	LCS-	1-43
	LCSA-	1-43
	LCSB-	1-44
	LCSE-	1-43
	LCSF-15	1-33
	LCSH-9.5	1-43
	LCSI-10	1-45
	LCSJ-16	1-43
	LCSL-4.8	1-44
	LCSLR-9.5	1-44
	LCT-9	1-36
	LCTA-4.8	1-35
	LCTA-12.7	1-35
	LCU-18	1-89
	LCUA-11	1-84
	LCUAC-2L	1-85
	LCUAC-2R	1-85
	LCUAC-3L	1-85
	LCUAC-3R	1-85
	LCUAC-7L	1-86
	LCUAC-7R	1-86
	LCUAC-8L	1-86
	LCUAC-8R	1-86
	LCUAC-9L	1-86
	LCUAC-9R	1-86
	LCUAC-11L	1-86
L	LCUAC-11R	1-86
	LCUAD-1	1-84
	LCUAE-8L	1-86
	LCUAE-8R	1-86
	LCUAE-12L	1-87
	LCUAE-12R	1-87
	LCUAE-16LA	1-87
	LCUE-3.3	1-83
	LCV-	1-29
	LCVA-	1-29
	LCVU-	1-29
	LCX-31	1-30
	LCY-4.8	1-44
	LD54-10.5	2-14
	LDD-10	1-77
	LDD-10(2)	1-77
	LDE-33	1-30
	LEAH-4.5	3-7
	LEAK-17.5	3-5
	LEAK3-17.5	3-5
	LEC-1	2-17
	LECC-8.5	2-12
	LED-	2-1
	LED-208	2-16
	LED-301	3-1
	LED-301(B)	3-1
	LED-301A	3-1
	LED-305	3-16
	LED-306	3-15
	LED-306(A)	3-15
	LED-306(B)	3-15

索引 INDEX

Part No.	Page
LED-307	3-15
LED-307(A)	3-15
LED-308	3-15
LED-310	3-16
LED-312	3-1
LED-313	3-1
LED-314	3-1
LED-316	3-1
LED-317	3-16
LED-319	3-2
LED-322	3-15
LED-323	3-15
LED-324	3-15
LED-325	3-1
LED-326	3-1
LED-328	3-1
LED-330	3-18
LED-331	3-18
LED-340	3-20
LED-341	3-21
LED-342	3-16
LED-343	3-2
LED-344	3-2
LED-345	3-20
LED-501	3-8
LED-502	3-7
LED-502S	3-7
LED-503	3-8
LED-504	3-7
LED-505	3-6
LED-521	3-16
LED-525	3-18
LED-528	3-7
LED-535	3-7
LED-542	3-7
LED-6301	3-2
LED-6302	3-15
LED-6303	3-15
LED-6501	3-8
LED101	3-21
LED1L-	3-13
LED1L-2.5	3-7
LED2M-3.6	2-4
LED2M-9.1	2-4
LED2X7.5	2-14
LED3-	2-26
LED3-1	2-21
LED3-1B	2-20
LED3-2	2-20
LED3-3	2-23
LED3-4	2-21
LED3-5	2-21
LED3-6	2-21
LED3-7	2-21
LED3-8	2-21
LED3-14-3S	2-30
LED3-14-4S	2-30
LED3-16	2-27
LED3-16M	2-27
LED3-17	2-27

Part No.	Page
LED3-17-0.6	2-28
LED3-18	2-27
LED3-19	2-22
LED3-20	2-21
LED3-21	3-2
LED3-22	2-22
LED3-23	2-21
LED3-24	2-27
LED3-25	2-27
LED3-28	2-22
LED3-29	2-21
LED3-30	2-28
LED3-31	2-28
LED3-33	2-27
LED3-34	2-21
LED3-35	2-27
LED3-37	2-22
LED3-38	2-22
LED3-40	2-28
LED3-40S	2-28
LED3-41	2-28
LED3-42	2-28
LED3-43	2-27
LED3-44	2-22
LED3-45	2-22
LED3-46	2-22
LED3-47	2-30
LED3-48	2-30
LED3-49	2-28
LED3-50	2-28
LED3-50L	2-28
LED3-53	2-23
LED3-55	2-27
LED3-59	2-27
LED3-61	2-22
LED3-XXM	2-26
LED3A-9	2-16
LED3X	2-15
LED3X1.5R	2-15
LED3X6-1	2-15
LED3X8R	2-15
LED3X13-1	2-15
LED3X16-1	2-15
LED4AX5	2-16
LED4X7	2-16
LED5-	2-27
LED5-1	2-23
LED5-1S	2-23
LED5-2	2-24
LED5-3	2-26
LED5-4	2-26
LED5-5	2-24
LED5-5T	2-24
LED5-6	2-24
LED5-8	2-25
LED5-8T	2-25
LED5-9	2-25
LED5-9S	2-25
LED5-10	2-26
LED5-11	2-25

Part No.	Page
LED5-13	2-25
LED5-14	2-26
LED5-16S	2-25
LED5-18L	2-27
LED5-24	2-28
LED5-24L	2-28
LED5-24M	2-28
LED5-25	2-26
LED5-27T	2-25
LED5-28	2-24
LED5-29	2-24
LED5-XXM	2-27
LED54-	2-14
LED5L-	3-13
LEDA-2	3-8
LEDA-2S	3-8
LEDA-4	3-3
LEDA-5	3-3
LEDA-6	3-3
LEDA-7	3-8
LEDA-15	2-2
LEDA-17	3-6
LEDA-17-1	3-6
LEDAA-22	2-7
LEDAC-14.5	2-10
LEDAC-18	2-10
LEDAJ-1.3	2-8
LEDAJ-5	2-8
LEDAJ-7.9	2-8
LEDAK-9.5	2-10
LEDBA-2.5	2-8
LEDBB-3	2-8
LEDBC-1.6	2-8
LEDBD-4.8	2-8
LEDBF-10	2-6
LEDBJ-	2-17
LEDD-12	2-5
LEDE-17.5	2-2
LEDEW-	2-2
LEDF-2	2-4
LEDF-3	2-5
LEDG-3	2-9
LEDG-4	2-9
LEDG-10	2-9
LEDH-	2-9
LEDH-2S	2-9
LEDHA-4	2-9
LEDHB-2.3	2-8
LEDHC-4	2-9
LEDI3-3	2-20
LEDJ-4	2-17
LEDJ-4.5	2-17
LEDJ-7.5	2-17
LEDJ-8	2-17
LEDJ-8.5	2-17
LEDK-	2-11
LEDK-4S	2-11
LEDK-5	2-11
LEDKB-17.7	2-12
LEDKU-2	2-11

Part No.	Page
LEDL-3	2-4
LEDL-5.5	2-4
LEDLA-9.8	2-2
LEDM-	2-7
LEDMK-1	2-29
LEDMK-3	2-29
LEDMK-5	2-29
LEDMU-	2-13
LEDMU-9	2-14
LEDO-	2-7
LEDP-	2-16
LEDP3-6.4	2-17
LEDQ-5	2-8
LEDR-1	2-13
LEDS-	2-3
LEDS-XXS	2-3
LEDSA-6	2-10
LEDSB-11	2-2
LEDSC-2	2-14
LEDSH-	2-10
LEDSS-	2-20
LEDsw-18.5	2-2
LEDT-	2-10
LEDT-6.4S	2-10
LEDU-	2-13
LEDU-1.5	2-13
LEDU-2	2-13
LEDUA-5.4	2-18
LEDUA-6.5	2-18
LEDUA-8	2-18
LEDV-5.5	2-9
LEDV-42	2-9
LEDW-	2-1
LEDW-20	2-1
LEDWA-23.7	2-12
LEDWK-	2-11
LEDX3-1	2-6
LEDX3-3	2-6
LEDX5-1	2-6
LEDX5-2	2-6
LEDXA-15.6	2-7
LEDXA5-2	2-6
LEDXB-7.5	2-6
LEDXK3-4.5	2-12
LEDXK3-5.5	2-12
LEDXV-	2-7
LEDZ3-9	2-5
LEDZ5-	2-5
LEF-1	2-18
LEFS-2	7-57
LEH3-16	2-4
LEJ-	3-4
LEJ3-5	3-4
LEJ-4M	3-4
LEJ-4S	3-4
LEJA-5	3-4
LEJB-4	3-11
LEJN-4	3-4
LEJT-4	3-4
LEK-301	3-3

Part No.	Page
LEK-302	3-3
LEK-303	3-4
LEK-303L	3-4
LEK-304	3-5
LEK-307	3-17
LEK-310	3-5
LEK-311	3-3
LEK-312	3-6
LEK-314	3-5
LEK-315	3-20
LEK-316	3-16
LEK-320	3-17
LEK-323	3-17
LEK-325	3-17
LEK-327	3-17
LEK-330	3-19
LEK-331	3-19
LEK-340	3-21
LEK-345	3-17
LEK-348	3-19
LEK-349	3-6
LEK-350	3-6
LEK-501	3-12
LEK-502	3-10
LEK-503	3-12
LEK-505	3-12
LEK-506	3-11
LEK-507	3-11
LEK-508	3-12
LEK-509	3-9
LEK-512	3-18
LEK-513	3-9
LEK-515	3-18
LEK-516	3-10
LEK-517	3-12
LEK-518	3-14
LEK-520	3-14
LEK-525	3-9
LEK-526	3-10
LEK-528	3-11
LEK-530	3-9
LEK-531	3-9
LEK-533	3-10
LEK-534	3-10
LEK-535	3-10
LEK-539	3-10
LEK-541	3-9
LEK-545	3-9
LEK-546	3-12
LEK-547	3-10
LEK-548	3-9
LEK-549	3-11
LEK-551	3-9
LEK-555	3-5
LEK-556	3-12
LEK-560	3-11
LEK-561	3-11
LEK-3111	3-5
LEK3X5.3	2-15
LEK54-17	3-5

Part No.	Page	Part No.	Page	Part No.	Page	Part No.	Page	Part No.	Page
LEK503-7	3-12	LEM-95	2-47	LEM-213	2-41	LMSP-	1-32	M-3/8-27	1-111
LEK503-18	3-12	LEM-96	2-37	LEM-221	2-47	LO-	7-83	M-10	8-5
LEKC-5.8	2-13	LEM-97	2-45	LEM-223	2-46	LO-6052	7-82	M1.6-	8-6
LEKC-7	2-13	LEM-97S	2-45	LEM-225	2-52	LO-6053A	7-82	M2-	8-8
LEKH-	3-14	LEM-98	2-45	LEM-225-F	2-52	LOCK-	5-54	M2-XF	8-9
LEKH-4.5	3-14	LEM-99	2-47	LEM-233	2-45	LP-2	2-56	M2.5-	8-8
LEKH-4.5S	3-14	LEM-103	2-42	LEM-235	2-44	LP-3F	2-55	M2.5-XF	8-9
LEKH-12	3-5	LEM-106	2-51	LEM-235-7.2	2-44	LP-3-1F	2-55	M2.5L-13	8-8
LEKH-6301	3-14	LEM-107	2-47	LEM-240	2-46	LP-11F	2-55	M2.6-	8-8
LEKHA-1	2-30	LEM-108	2-39	LEM-244	2-37	LP-14-1F	2-55	M3-	8-8
LEKHD-1	2-29	LEM-110	2-47	LEM-248	2-45	LP-14F	2-55	M3-XXF	8-9
LEKHD-2	2-29	LEM-113	2-52	LEM-253	2-47	LPE1-5-	2-57	M3-XXFPK	8-8
LELG-1F	2-29	LEM-114	2-42	LEM-260-F	2-52	LPE1-5-20.5	2-53	M3-XXPK	8-7
LEM-1	2-37	LEM-115	2-47	LEM-261	2-47	LPE1-5-20.5S	2-53	M3.5-	8-9
LEM-2	2-37	LEM-122	2-40	LEM-262M	2-44	LPE1-10-	2-57	M4-	8-8
LEM-3	2-38	LEM-123	2-34	LEM-266	2-45	LPE1-10.2-25.5	2-54	M4-8L	8-10
LEM-3L	2-38	LEM-131	2-38	LEM-267	2-51	LPE1-10.5-40	2-53	M4-9NBD	8-10
LEM-4	2-40	LEM-132	2-44	LEM-269	2-53	LPE1-15-	2-57	M4-XXF	8-9
LEM-5	2-42	LEM-133	2-46	LEM-270	2-51	LPE2-5-	2-58	M5-15F	8-9
LEM-5-57	2-42	LEM-135	2-45	LEM4W-	2-48	LPE2-5-19C	2-57	M5-16	8-8
LEM-6	2-39	LEM-135-4.8	2-45	LEMA-1	2-35	LPE2-10-	2-58	M5-20	8-8
LEM-7	2-36	LEM-136	2-52	LEMA-2	2-31	LPE2-15-	2-58	M5A-65	8-11
LEM-7S	2-36	LEM-136-F	2-52	LEMA-2F	2-31	LPE3-5-	2-58	M6-4	8-11
LEM-9	2-38	LEM-137	2-40	LEMA-3F	2-31	LPE3-5-22C	2-57	M6-8F	8-11
LEM-11	2-40	LEM-141	2-44	LEMA-5	2-36	LPE3-7.8	2-54	M8-7	8-11
LEM-12	2-38	LEM-144	2-43	LEMA-6F	2-32	LPE3-10-	2-58	M12-2	8-5
LEM-13	2-43	LEM-145	2-52	LEMB1-XX-F	2-49	LPE3-15-	2-58	MA-	1-49
LEM-16	2-38	LEM-149	2-34	LEMB2-XX-F	2-49	LPE4-3.6	2-54	MA-2.5S	1-49
LEM-18	2-41	LEM-150	2-46	LEMB3-XX-F	2-49	LPE4-5-	2-58	MA-2.8S	1-49
LEM-20	2-42	LEM-150-	2-46	LEMB3.5-2-F	2-49	LPE4-5-18	2-58	MA-3S-1	1-49
LEM-23	2-43	LEM-151	2-37	LEM-C1-	2-48	LPE4-10-	2-58	MA-XXDL	1-49
LEM-24	2-41	LEM-156	2-44	LEM-C2-	2-48	LPE4-10-24	2-58	MAB-4	1-49
LEM-24-	2-41	LEM-161	2-36	LEM-D1-	2-49	LPE4-15-	2-58	MABA-2.6	1-49
LEM-28	2-51	LEM-166	2-56	LEM-D2-	2-49	LPEB3-1	2-54	MAC-40	1-17
LEM-29	2-36	LEM-167	2-45	LEQ-1	2-18	LPEB4-1	2-54	MAC-40S	1-17
LEM-30	2-36	LEM-167-11	2-45	LEQ-2	2-19	LPED2-1	2-55	MAD-	1-14
LEM-33	2-42	LEM-167-15	2-45	LEQ-2T	2-19	LPED4-1F	2-55	MAD1-3	1-13
LEM-36	2-38	LEM-180	2-51	LEQ-3	2-19	LPF1-517	2-54	MAD1-19	1-13
LEM-40	2-39	LEM-184	2-50	LEQU3-1	2-23	LPF1-518	2-54	MAD1.2-6	1-14
LEM-52	2-42	LEM-185	2-47	LEQU3-2	2-23	LPG-1	2-56	MAD1.2-8	1-14
LEM-53	2-44	LEM-188	2-48	LEU-1	2-59	LPG-2	2-56	MAD1.2-12.9	1-13
LEM-53-	2-44	LEM-188-17	2-48	LEU-2	2-59	LPG-3	2-56	MAD1.7-9.8	1-13
LEM-54	2-36	LEM-189	2-45	LEU-4	2-59	LPH-2B	2-56	MAD3.5-12	1-19
LEM-55	2-36	LEM-191	2-44	LGT-	5-15	LPH-4	2-57	MADA-	1-16
LEM-61	2-52	LEM-191-	2-44	LH-330	3-19	LPH-4-1	2-57	MADA-18S	1-15
LEM-62	2-38	LEM-192	2-45	LH-340	3-20	LPZ-1	1-93	MADAA-14	1-15
LEM-63	2-39	LEM-193	2-44	LHC-8	1-72	LPZ-2	1-93	MADAB-4.3	1-17
LEM-67	2-44	LEM-195	2-53	LHC-12	1-72	LPZ-5	4-111	MADB-3.5	1-14
LEM-67-	2-44	LEM-196	2-46	LIES-1	1-75	LPZ-6	1-93	MADB-6	1-14
LEM-69	2-50	LEM-197	2-46	LIH-8	1-90	LPZ-9	1-93	MADD-2	1-18
LEM-70	2-47	LEM-198	2-44	LIJ-4	1-69	LPZA-1	1-93	MADE-2.8	1-17
LEM-72	6-84	LEM-199	2-44	LIO-8	1-69	LSF-002	9-21	MADG-5.4	1-36
LEM-73	2-39	LEM-200	2-47	LIO-10	1-69	LUCE-1	1-91	MADJ-6	1-15
LEM-79	2-37	LEM-202	2-44	LIO-10.5	1-69	LUS-	1-98	MADL-27.8	1-18
LEM-87	2-44	LEM-205	2-40	LLCB3-15	1-145	LUS2-8.2	1-99	MADM-	1-16
LEM-88	2-45	LEM-207	2-53	LMSA-6	1-32	LUSA-11	1-99	MADM1-2.2	1-17
LEM-90	2-45	LEM-207B	2-53	LMSB-4	1-32	LUSB-10	1-99	MADMK-5	1-20
LEM-91	2-45	LEM-208	2-46	LMSD-12	1-45	LUSS-	1-99	MADN-24	1-18
LEM-92	2-41	LEM-210	2-39	LMSD-16	1-45	M	5-20	MADS-6.5	1-13
LEM-93	2-42	LEM-212	2-41	LMSE-4.8	1-32	M-	8-4	MADS-19.2	1-13

Part No.	Page	Part No.	Page	Part No.	Page	Part No.	Page	Part No.	Page
MADSA-3	1-13	MB-14	7-59	MBW-36	7-63	MCFJ-2	1-131	MIB-11	4-40
MADSB-3	1-13	MB-18	7-55	MBW-38	7-63	MCFL-3310	1-129	MIB-17	4-40
MADX-9.5	1-14	MB-19	7-55	MBW-40	7-63	MCFM-2807	1-130	MIB-21	4-40
MAE-	1-53	MB-20	7-60	MBW-41	7-64	MCFO-	1-129	MIB-22	4-42
MAE-7-440	1-54	MB-27	7-55	MBW-42	7-62	MCFP-5	1-133	MIB-23	4-42
MAE-7-440T	1-54	MB-32	7-58	MBW-42S	7-62	MCFP-7	1-133	MIB-24	4-42
MAE-XXT	1-53	MB-33	7-58	MBW-46	7-65	MCFP-9	1-133	MIB-26	4-42
MAE2.5-6.5	1-53	MB-36	7-55	MBW-48	7-63	MCFP-12	1-134	MIB-28	4-42
MAE2.5-6.5T	1-53	MB-39	7-55	MBW-51	7-62	MCFP-17-1	1-134	MIB-32	4-9
MAE4-	1-55	MB-43	7-55	MBW-52	7-62	MCFP-18	1-134	MIB-33	4-40
MAE4-XXT	1-55	MB-45	7-58	MBW-55	7-62	MCFP-25	1-134	MIB-34	4-40
MAE43-	1-54	MB-52	7-55	MBW-61	7-62	MCFP-29	1-134	MIB-35	4-40
MAE43-4.8LT	1-54	MB-53	7-58	MBW-71	7-62	MCFP-30	1-133	MIBA-	4-72
MAE43-XXT	1-54	MB-55	7-55	MBW-73	7-62	MCFP-31	1-133	MIBA-4	4-10
MAE4D-6	1-54	MB-56	7-55	MBW-74	7-62	MCFP-32	1-133	MIBB-	4-10
MAE4D-6T	1-54	MB-63	7-59	MBW3-8	7-64	MCFP-33	1-131	MIBB-1	4-9
MAEA-3.5	1-20	MBB-	7-76	MBW5-12	7-62	MCH-	1-58	MIBB-2	4-9
MAEA-3.5L	1-20	MBC-11	1-61	MBW6-11	7-63	MCI-4.7	1-55	MIBB-6	4-9
MAEA-3.5LS	1-20	MBD-10	1-61	MBW7-20	7-63	MCIA-12	1-59	MIBB-7	4-9
MAEA-3.5M	1-20	MBE4-1.2	7-60	MBWB-	7-64	MCIA-16	1-59	MIBB-9	4-9
MAEB-3.2	1-19	MBG2-8.7	7-61	MBWC-	7-64	MCL-9	1-58	MIBB-10	4-29
MAEE-4.5	1-19	MBH-1	5-17	MBWK	5-18	MCL-16	1-58	MIBB-14	4-29
MAF-	1-19	MBL3-	7-58	MC-	1-57	MCM-8	1-51	MIBB-18	4-29
MAFA-6	1-19	MBL4.8-	7-59	MC-	1-58	MCM-14.5	1-51	MIBD-3	4-9
MAFB5-0.8	1-19	MBP-	5-18	MCB-6	1-61	MCN-10	1-57	MIC-	6-86
MAFB5-9.7	1-19	MBPP-	5-19	MCC-	7-76	MCO-16	1-51	MIC-6	6-86
MAHA-7	1-15	MBS-	1-63	MCE-1.9	1-58	MCSH-7.2	1-55	MIC-10	6-86
MAHC-14.3	1-17	MBS3-	7-57	MCEA-1.9	1-58	MDLS-4.5	1-19	MIC-31	6-87
MAHC-XXS	1-17	MBT-	7-60	MCF-1	1-131	MEE-	7-76	MIC-39	6-87
MAL-34	1-50	MBT-1	7-57	MCF-428	1-130	MGFA-2	9-14	MIDP-	7-23
MAL-8	1-48	MBT-2	7-57	MCF-2310	1-129	MGFF-4	9-14	MIHDMI-	7-24
MAM-	1-50	MBT-7	7-59	MCF-2908	1-130	MGM-	5-1	MIL4-20	8-9
MAMA-3.5	1-50	MBT-10	7-59	MCF-3305	1-129	MHC-1	5-17	MINI-1	10-49
MAMDA-	1-15	MBT-14	5-19	MCF-3308	1-129	MHCA	5-24	MINI-2	10-49
MAMDC-12	1-18	MBT-15	7-59	MCF-4213	1-129	MHD-	5-16	MIOSD-1	7-42
MAMDD-6	1-20	MBT-17	7-59	MCFA-2508	1-129	MHDA	5-24	MIS-	4-68
MAMDF-7	1-16	MBT2.3-1.6	7-59	MCFA-2511	1-129	MHDS-1	5-16	MIS-2	4-67
MAMD-9	1-16	MBT2.5-3.2	7-59	MCFC-2508	1-129	MHE-11	5-17	MIS-3	4-67
MAMS-	1-49	MBT3-2	7-59	MCFD-1	1-130	MHF-	5-17	MIS-4	4-69
MAMS-7.5	1-49	MBT3.1-0.8	7-60	MCFD-2810	1-129	MHSC-	7-36	MIS-5	4-67
MAS-9	1-13	MBT4-2	7-59	MCFD-3210	1-129	MI1.2-XXNGF	8-6	MIS-6	4-69
MASD-0.8	1-48	MBT6-2	7-60	MCFF-	1-130	MI2-	8-6	MIS-9	4-67
MASD-2	1-48	MBT6.2-3	7-60	MCFF-5	1-131	MI2-XXF	8-6	MIS-11	4-67
MASL-5.4	1-48	MBTA-1	7-80	MCFF-6	1-131	MI2.5-4	8-7	MIS-18	4-72
MASS-	1-48	MBU3-3	7-57	MCFF-7	1-132	MI2.5-5	8-7	MIS-20	4-67
MASSD-14	1-13	MBW-	7-61	MCFF-11	1-130	MI2.5-12	8-7	MIS-23	4-69
MASSD-18	1-13	MBW-7	7-62	MCFF-12	1-133	MI2.5-12S	8-7	MIS-27	4-93
MAST-6	1-48	MBW-7S	7-62	MCFF-13	1-132	MI2.5-16	8-7	MIS-28	4-69
MAST-18	1-48	MBW-9	7-61	MCFF-15	1-132	MI3-	8-7	MISA-1	4-69
MB-	7-56	MBW-14	7-62	MCFF-16	1-132	MI3-6R	8-7	MISA-2	4-70
MB-1	7-54	MBW-17	7-62	MCFF-17	1-132	MI3-XXPK	8-7	MISA-3	4-21
MB-2	7-54	MBW-18	7-63	MCFF-18	1-130	MI4-	8-7	MISA-4	4-73
MB-3	7-54	MBW-21	7-63	MCFF-20	1-130	MI420-25.4	8-10	MISB-	4-69
MB-4	7-54	MBW-22	7-64	MCFF-21	1-130	MIA6-16	8-12	MISD-1	4-21
MB-5	7-54	MBW-23	7-62	MCFF-24	1-130	MIA8-20	8-12	MISE-1	4-70
MB-6	7-55	MBW-24	7-62	MCFF-25	1-129	MIB-	4-41	MO-	8-4
MB-7	7-55	MBW-27	7-62	MCFG-3010	1-129	MIB-2	4-42	MO-	8-5
MB-8	7-59	MBW-28	7-62	MCFG-35810	1-129	MIB-6	4-42	MO-	8-6
MB-10	7-59	MBW-29	7-62	MCFJ-	1-129	MIB-9	4-40	MO-6G-68	8-4
MB-12	7-59	MBW-34	7-63	MCFJ-1	1-131	MIB-10	4-40	MO-8G-85	8-4

Part No.	Page
PCB-49(M3)	10-19
PCB-50M5F	10-19
PCB-54L(M3)	10-23
PCB-54R(M3)	10-23
PCB-55(M3)	10-23
PCB-58M4	10-17
PCB-60	10-20
PCB-66	10-16
PCB-67	10-44
PCB-68	10-45
PCB-69(1032)	10-20
PCB-70	10-14
PCB-71	10-17
PCB-73	10-22
PCB-74	10-22
PCB-75	10-17
PCB-77	10-24
PCB-78	10-15
PCB-82	10-20
PCB-82-1	10-20
PCB-93	10-34
PCB-99	10-23
PCB-100	10-31
PCB-102	10-14
PCB-106	10-17
PCB-128	10-15
PCBS-	1-9
PCBT-10	1-9
PCBT-4.8	1-9
PCBTA-4.8	1-9
PCC-6	1-68
PCC-11	1-68
PCF110	10-21
PCF1108	10-21
PCF187	10-21
PCF250	10-21
PCF250-7	10-31
PCF250-11	10-21
PCFL250	10-21
PCFS156A	10-24
PCFS187	10-25
PCFS2505	10-25
PCFS2505A	10-25
PCFS2508	10-25
PCFS2508A	10-25
PCFS2509A	10-25
PCFS250L	10-25
PCH250	10-28
PCH250-1	10-28
PCIE-	7-35
PCIEC-1	7-27
PCIEX-1	7-9
PCK250	10-30
PCLS-25	1-52
PCLT-10	10-22
PCLT-11	10-22
PCLT-250	10-26
PCLTA-1	10-22
PCLTA-2	10-31
PCLTM-250	10-26

Part No.	Page
PCMIC-	7-40
PCR187	10-29
PCR187(0.8)	10-29
PCR250	10-29
PCR250-S	10-29
PCRL250	10-21
PCRN250	10-30
PCRS187A	10-30
PCRS205	10-29
PCRS250	10-29
PCRS250-1	10-29
PCRS250-2	10-29
PCTL-2	10-34
PCTL-3.5	10-35
PCTT-	6-78
PCU250	10-30
PDC-	1-56
PDC-4.5D	1-56
PDC-5	1-57
PDC-9	1-57
PDC-10	1-57
PDC-XXD	1-57
PEB3-25	7-91
PEB4-20	7-91
PEB4-29	7-92
PEB4-30	7-92
PEB5-40.5	7-91
PEB6-	7-91
PEB8-38	7-92
PEBR-1	7-91
PEC5-	7-91
PENCOMC-1	6-83
PH-	6-11
PH-13	6-12
PH-15	6-15
PH-16	6-12
PH-18	6-12
PH-20	6-12
PH-21	6-12
PH-22	6-13
PH-23	6-13
PH-25	6-80
PH-26	6-63
PH-27	6-13
PH-28	6-15
PH-30	6-13
PH-31	6-13
PH-34	6-15
PH-37	6-14
PH-40	6-13
PH-41	6-80
PH-43	6-15
PH-44	6-5
PH-46	6-12
PH-48	6-15
PH-49	6-13
PH-50	6-12
PHC-	6-63
PHC-13	6-64
PHC-14	6-63

Part No.	Page
PHC8NNHA	6-63
PHG-	6-14
PHG-7	6-15
PHG-15	6-15
PHK-1	6-12
PIC-	7-65
PIN	7-67
PIN-1	10-26
PIN-2	10-26
PIN-9	10-26
PJB-45	7-17
PJBA-45	7-17
PJC-45	7-17
PJCV-	7-10
PJD-45	7-18
PJR-45	7-18
PJRA-45	7-17
PJS-45	7-17
PJSA-45	7-17
PJT-45	7-16
PJU-45	7-16
PJV-45	7-18
PL1-	2-50
PL2-XX-F	2-50
PLC-	7-33
PLCC-	7-31
PLCC-2	7-32
PLCC-3	7-32
PLCC-5	7-32
PLCC-7	7-33
PLCC-16	7-32
PLCD-	7-31
PLT130T	6-51
PMB-1	1-92
PMB-2	1-92
PMR-1	2-59
PMR-2	2-59
PMR-3	2-59
PMR-6	2-60
PMR-7	2-61
PMR-8	2-61
PMR-10	2-60
PMR-11	2-60
PMR-12-1F	2-32
PMR-12F	2-32
PMR-13	2-60
PMR-14	2-61
PMR-15	2-61
PNL-	7-66
PNLA-	7-66
PNLS-	7-66
PNLSA-8	7-66
PR-	7-50
PR-1	7-49
PS-16	1-88
PSR-	7-52
PSR-8	7-52
PSR3-5.5	7-53
PSR4-	7-53
PSR4-12	7-53

Part No.	Page
PSR5-7	7-52
PSR5.1-7	7-52
PSR5.5-	7-52
PSR6-	7-53
PSR6-1	7-53
PSR48-10	7-53
PSR64-25	7-54
PSRB-1	7-54
PT	9-24
PT-1762	9-24
PUCP-1	2-19
PVC套管	5-59
PW-	6-61
PWIC-	7-36
QCL-	6-64
QW-	6-65
QW-4	6-66
R	6-78
R3	10-4
R6	10-4
R7-13	1-97
R440-	8-8
R632-	8-8
RA-35	9-9
RA-40	9-9
RA-40S(RU)	9-9
RA-45	9-9
RA-45-1(RU)	9-9
RA-45S	9-9
RA-45S-1	9-9
RA-45S-1(RU)	9-9
RA-45S-3	9-9
RA-57	9-9
RA-57S(RU)	9-9
RAD-	1-1
RAFF-40	9-9
RAM-	1-1
RAM-13.5L	1-1
RAMA-	1-1
RAMB-9	1-3
RAMC-	1-2
RAMD-15.5	1-3
RAML-	1-1
RAS-	1-2
RBS-	1-11
RBT-	1-11
RBT-XXL	1-11
RCA-	1-4
RCAB-	1-12
RCAB-4.5S	1-12
RCAC-	1-12
RCB-	1-6
RCBC-12	1-8
RCBL-6	1-6
RCBS-	1-8
RCC-	1-4
RCCA-8	1-5
RCD-	1-6
RCEA-	6-49
RCEB-	6-50

Part No.	Page
RCEC-2	6-49
RCEE-7	6-50
RCEF-1	6-49
RCEH-1	6-51
RCF-	1-7
RCFA-7	1-10
RCFB-10	1-10
RCFL-	1-10
RCG-	1-5
RCH-	1-5
RCI-2.6	1-3
RCI-5	1-6
RCJ-	1-11
RCM-	1-7
RCMA-3	1-5
RCMB-2.8	1-5
RCMD-6	1-7
RCO-2.5	1-3
RCO-2.5L	1-3
RCOC-7	1-24
RCR-12.7	1-9
RCR-3.2	1-8
RCRA-9.5	1-9
RCS-	1-6
RCSL5-10	1-97
RCSL6-8.5	1-97
RCT-4.5	1-10
RCT-8	1-10
RCTA-4.5	1-10
RCTL-	1-11
RCV-11.1	1-8
RCW-	1-8
RCWA-	1-8
RCWB-21	1-8
RCXL-1	1-96
RCXL-14	1-96
RECA-	6-47
RECC-	6-47
RECD-1	6-51
RECD-3	6-46
RECE-	6-47
RECG-	6-47
RECI-1	6-47
RF	9-19
RF-	9-16
RF-	9-17
RF-	9-19
RF-004	9-16
RF-016	9-17
RF-017	9-17
RF-018	9-17
RF-029	9-17
RF-031	9-17
RF-1094A	9-16
RF3.8-2	9-19
RF4-	9-19
RF4.5-	9-19
RF4.8-1	9-19
RF5-	9-19
RF5.3-0.7	9-19

Part No.	Page	Part No.	Page	Part No.	Page	Part No.	Page	Part No.	Page
RF5.5-1.6	9-19	RF25-2.3	9-19	S6-32	8-4	SF	9-22	SQH-	5-41
RF5.6-2	9-19	RF27-3	9-19	S440-	8-9	SF-	9-20	SQHB-	5-42
RF5.8-4A	9-16	RF27-7AC-1	9-16	S632-	8-9	SF-	9-21	SQHB-8	5-43
RF6-	9-19	RF28-3.2	9-19	SATAC-	7-22	SF-	9-22	SQHB-9	5-43
RF6-5	9-16	RF30-2	9-19	SATAC-1	7-21	SF141410	9-24	SQHB-10	5-41
RF6.4-2.6	9-19	RF40-1	9-19	SATAC-2	7-21	SF14722	9-23	SQHB-13	5-43
RF6.5-	9-19	RF58-	9-19	SB-2	5-2	SF202013	9-23	SQHB-14	5-41
RF6.6-	9-19	RF64.7-2.5S	9-19	SB4F-	5-31	SF28722	9-23	SQI-1	5-38
RF7-	9-19	RJ-22	7-16	SB4F-2	5-27	SFA-1	5-55	SOJ-	5-37
RF7-3.2A	9-16	RJ-45	7-17	SB4F-9	5-27	SFPC-	7-19	SOJA-	5-37
RF7-4.2A	9-16	RLA-1	1-95	SB4L-4	5-29	SFPC-9	7-20	SOQ-1	5-36
RF7.2-1.5	9-19	RLA-12.7	1-95	SB4L-6	5-27	SFPC-15	7-20	SQL-1	5-36
RF7.5-2	9-19	RLL-	1-96	SB5F-	5-28	SFPC-19	7-20	SQM-	5-41
RF7.8-2.9A	9-17	RML-1	1-95	SB5L-4	5-29	SFPC-21	7-20	SQN-	5-40
RF8-	9-19	RML-25	1-95	SB5P-2	5-27	SFPC-22	7-20	SQR-1	5-38
RF8-3.5	9-16	RMM-	1-95	SB5R-2	5-27	SI	9-25	SQS-	5-43
RF8-6.5A	9-16	ROFF-10F	10-9	SB5R-4	5-28	SI	9-26	SR	7-44
RF8-XA	9-17	RPCL-11	6-62	SB5R-5	5-31	SI12243H6A	9-26	SR3-4.7F	7-45
RF8.2-5	9-16	RPCL-9	6-62	SB6L-6	5-29	SI30172H	9-26	SR3-13F	7-45
RF8.5-	9-19	RR-1	1-98	SB6P4-4	5-28	SI3030-1	9-25	SR4-	7-45
RF8.8-2.9A	9-17	RS-28	9-8	SB6R-6	5-28	SI335125H2	9-26	SR4-XXF	7-45
RF9-	9-19	RS-28(N)N	9-8	SB7L-2	5-29	SI34132H	9-26	SR4.3-5	7-45
RF9-3.5	9-16	RS-28N(RU)	9-8	SB7R-7	5-30	SI8925H5	9-26	SR4.5-21.3	7-45
RF9.5-	9-19	RS-28S(RU)	9-8	SB8R-2	5-28	SLC-	4-99	SR5-	7-45
RF9.5-3.9A	9-17	RS-40	9-8	SB9R-2	5-28	SLC-17	4-98	SR5-4.5F	7-45
RF9.7-4.2A	9-16	RS-40S(RU)	9-8	SBA-1	5-5	SLCA-15	4-99	SR6-	7-45
RF10-	9-19	RS-45	9-8	SBB-1	5-32	SLCB-8	4-98	SRB-1	7-47
RF10-6.2A	9-16	RS-45(S)I	9-8	SBCR-	5-33	SLCC-	4-99	SRCC-	7-50
RF10.5-	9-19	RS-45S(RU)	9-8	SBQC-1	5-32	SLCD-9.5	4-99	SRCC-9	7-49
RF11-3.2A	9-16	RS-50	9-8	SBU-	5-32	SLCE-13	4-99	SRCC-11	7-49
RF11-5	9-16	RS-50-2	9-8	SBU4-	5-31	SLCPA-	4-99	SRCC-12F	7-49
RF12-	9-19	RS-50N	9-8	SBUT-1	5-41	SLP-3	2-54	SRCC-13	7-49
RF12-27A	9-16	RS-50S(RU)	9-8	SC-	5-4	SM3-	8-13	SRCC-16F	7-49
RF12.5-1	9-19	RS-55	9-8	SCAB-	7-43	SM4-	8-13	SRCC-18	7-49
RF12.7-6.2A	9-16	RS-55S(RU)	9-8	SCAB-2F	7-43	SM632-	8-13	SRCC-18	7-49
RF13-	9-19	RS-60	9-8	SCB-	1-127	SMAP-	4-129	SRE2.6-4.8	7-46
RF14-4	9-19	RS-60N	9-8	SCB-6SM3	1-127	SMHC-1	1-91	SRE3-	7-46
RF14-5A	9-16	RS-61N	9-6	SCB-8.5S	1-127	SMO-	8-3	SRF3.5-	7-47
RF14-8A	9-17	RS-61S	9-6	SCB-10SA	1-127	SOR-1	1-74	SRF4-	7-46
RF14.5-4	9-19	RSS-	1-96	SCB-XXS	1-127	SOR-2	1-74	SRF4-4.6F	7-46
RF15-11A	9-16	RSUA-1	1-95	SCB3-	1-126	SOR-3	1-74	SRF4-8	7-46
RF15-13.5A	9-16	RSUS632	8-18	SCB3-38	1-126	SP1-4.8	1-28	SRFA3-	7-46
RF15.5-5A	9-16	RSUS632-6	8-18	SCB4-	1-127	SPK-	7-80	SRH4.2-8	7-47
RF16.5-3	9-19	RU1420-8	8-11	SCB832-	1-127	SPLK-1	7-80	SRLA-29.5	1-65
RF17-11A	9-16	RWF3.5-	9-18	SCBA-	1-125	SPLK-2	7-81	SRLA-31.5	1-65
RF18-	9-19	RWF4.5-	9-18	SCBB-3	1-125	SPM-16	5-26	SRLCB-	1-64
RF18-5A	9-16	RWF7.2-2.8N	9-18	SCBC-	1-125	SPMA-	5-26	SRMA-	1-90
RF19-	9-19	RWF7.6-1.7N	9-18	SCBD-8	1-125	SPMA-12LF	5-26	SRMA-2	1-90
RF19-4A7	9-16	RWF8.5-3N	9-17	SCBS632-	1-125	SPMB-	5-26	SRMA-2F	1-90
RF20-	9-19	RWF10.2-2	9-18	SCCVA-	7-30	SQA-	5-38	SRMK-	7-79
RF20-5	9-16	RWF18-8.5-15	9-18	SCD-	6-79	SQB-	5-36	SRMKA-8	7-75
RF20-10	9-17	RWF20-1.5	9-18	SCMB-	1-90	SQC-3.4	6-61	SRR3.5-7.5	7-47
RF21-	9-17	RWF25-2	9-18	SCT-	6-74	SQD-1	5-36	SRR4.5-	7-46
RF21.6-11A	9-17	RWF40-2	9-18	SCW-	8-1	SQE-	5-35	SRRH4.5-12	7-47
RF22-	9-16	RWF43-2	9-18	SCW-3	8-1	SQF-	5-35	SRS3-13P	7-46
RF22-	9-19	RXL-	1-96	SCW-5	8-1	SQF-	5-35	SRS3.5-	7-46
RF22.1-10.4	9-19	RXS-1	1-94	SCWA-6	8-1	SQG-	5-39	SRS3.5-5P	7-48
RF22.8-5	9-16	RXS-13.5	1-94	SD-	7-42	SQG-5	5-40	SRS4-	7-48
RF24.6-3	9-19	S	6-77	SF	9-20	SQG-12	5-40	SRT	6-74
RF24-8	9-16	S4-40	8-4	SF	9-21	SQG-13	5-40	SRT-	6-74
						SQG-14	5-40	SRTA-1	6-75

Part No.	Page
SRU3.5-4.5	7-51
SS-	1-73
SS1-	1-72
SS1-XXL	1-72
SS1-XXS	1-72
SS2-	1-72
SS2-2.5U	1-72
SS2-XXS	1-72
SS3-7(1.3)	1-72
SS3.5-	1-73
SS4-	1-73
SSA-12.7	1-73
SSA4-5.5	1-73
SSDU-9.2	1-29
SSDU-9.6	1-29
SSDU1-3.5	1-28
SSDUA-16.5	1-28
SSU4-	1-73
SSUA4-6.3L	1-73
SSUL-8	1-75
ST-	5-50
ST-9	5-51
ST-19	5-51
ST-23	5-51
STAT-CV24	7-35
STB-	5-57
STC-	5-52
STCA-	5-53
STCB-110	5-53
STCC-123	5-49
STCL-100	5-53
STGM-	5-8
STL-	5-58
STM3-	8-10
STM4-	8-10
STM5-	8-10
STM6-12	8-10
STM632-	8-10
STO-166	5-51
STP-3.5	7-90
SUM-6	6-44
SUMA-6	6-44
SUS632	8-18
SUS832	8-18
SVDOC-	7-12
SVDOC-1S	7-14
SVDOC-2	7-14
SWB-	5-84
SWC-	6-80
SWCL-	6-84
SWCM-1	4-86
SWKL-	4-86
SWPC-	4-86
SWPK-15F	5-54
SWPL-	4-79
SWPL-2	4-80
SWPL-11	4-80
SWPL-15S	4-81
SWPL-16	4-83
SWPL-18	4-83

Part No.	Page
SWPL-19	4-82
SWPL-20	4-83
SWPL-21	4-83
SWPL-23	4-84
SWPL-27	4-80
SWPL-37-1	4-81
SWPL-37S-1	4-81
SWPL-43	4-84
SWPL-46	4-84
SWPL-50	4-85
SWPL-52	4-85
SWPL-55	4-85
SWPL-59	4-85
SWPL-64	4-84
SWPL-65	4-80
SWPL-66	4-80
SWPL-69	4-83
SWPL-72	4-82
SWPL-73	4-80
SWPL-76	4-81
SWPL-78	4-84
SWPL-82	4-83
SWPL-87	4-85
SWPL-88	4-80
SWPL-94	4-81
SWPL-96	4-80
SWPL-98	4-85
SWPL-100	4-80
SWPL-101	4-84
SWPL-103	4-80
SWPL-105	4-82
SWPL-106	4-82
SWS311030	6-65
SWV-4	8-3
SWVB-1	8-2
TC-	6-1
TC-21	6-2
TC-24	6-6
TC-25	6-6
TC-26	6-5
TC-28-	6-6
TC-29	6-2
TC-30	6-6
TC-31	6-5
TC-39	6-2
TC-41	6-2
TC-42	6-5
TC-47	6-5
TC-48	6-4
TC-49	6-3
TC-50	6-3
TC-51	6-3
TC-52	6-2
TC-53	6-2
TC-54	6-6
TC-58	6-3
TC-59	6-5
TC-60	6-4
TC-61	6-4
TC-62	6-4

Part No.	Page
TC-63	6-5
TC-65	6-7
TC-67	6-4
TC-68	6-4
TC-70	6-3
TC-71	6-3
TC-72	6-4
TC-76F	6-3
TC-77	6-3
TCBA-	1-51
TCBC-8.7	1-59
TCBC-13.7	1-59
TCBD-4.8	1-60
TCBE-8.7	1-60
TCBE-13.7	1-60
TCBH-17F	1-60
TCBS-	1-62
TCBS-18	1-62
TCBT-	1-62
TCBT-3.6	1-62
TCBT-19	1-62
TCEA-1	1-92
TCEB3-	1-65
TCEB3-9.5	1-65
TCEB3-11.1	1-65
TCEB4-	1-65
TCEB4-9.5	1-65
TCEB4-11.1	1-65
TCEB632-	1-65
TCEB632-9.5	1-65
TCEB632-11.1	1-65
TCEH-	1-128
TCEP4-	1-128
TCP-1	6-16
TCSE-	6-7
TCSF-	6-8
TERBL-6	10-3
TERBL-33	10-3
TEST-1	10-5
TEST-2	10-6
TEST-3	10-6
TEST-3S	10-6
TEST-4	10-7
TEST-5	10-7
TEST-6	10-7
TEST-7	10-6
TEST-7CN	10-6
TEST-8	10-7
TEST-9	10-8
TEST-10	10-7
TEST-12	10-8
TEST-22	10-7
TEST-23	10-8
TEST-24	10-8
TEST-25	10-8
TEST-26	10-8
TEST-27	10-8
TEST-28	10-8
TEST-31	10-7
TEST-34	10-7

Part No.	Page
TEST-55	10-6
TEST-87	10-6
TEST-114	10-9
TEST-115	10-9
TEST-129	10-6
TEST-136	10-8
TEST-140	10-8
TF-	5-22
TF-	5-23
TF-017	9-10
TF-018	7-95
TF-041	9-12
TF-1	7-89
TF-143	7-95
TF-144	7-95
TF-147	7-95
TF-246	7-28
TF-250	8-3
TF-263	2-29
TF-268I	7-72
TF-283	9-12
TF-346	5-8
TF-356	9-15
TF-395	5-15
TF-444	2-29
TF-448	9-10
TF-546	9-12
TF-561	9-10
TF-568	7-93
TF-589	7-11
TF-605	9-5
TF-1198	6-86
TF-1298	3-21
TF-1333	5-8
TF-1556	6-86
TF-1575	6-87
TF-1596	9-24
TF-1627	9-24
TF-1639	6-87
TF-1654	5-8
TF-1679	6-86
TF-1698	9-23
TF201113	9-24
TFA-2	7-90
TFF-	9-10
TGM-	5-9
TGM-	5-10
TGM-10SW	5-13
TGM-11	5-9
TGM-13SW	5-13
TGM-17	5-9
TGM-17SW	5-13
TGM-18	5-9
TGM-21	5-9
TGM-38	5-9
TGM-40	5-9
TGM-41	5-9
TGM-45	5-10
TGM-49	5-11
TGM-51	5-10

Part No.	Page
TGM-58	5-12
TGM-64	5-9
TGM-65	5-10
TGM-67	5-11
TGM-68	5-10
TGM-69	5-13
TGM-71	5-11
TGM-73	5-12
TGM-74	5-12
TGM-76	5-11
TGM-83	5-10
TGM-88	5-11
TGM-96	5-12
TGM-112	5-12
TGM-117	5-12
TGM-123	5-11
TGM-124	5-11
TGM-126	5-12
TGM-128A	5-14
TGM-132	5-12
TGM-140	5-11
TGM-141	5-11
TGM-149	5-11
TGM-152	5-11
TGM-166	5-11
TGM-173	5-10
TGM-174	5-11
TGM-176	5-12
TGM3-	5-13
TGM3-8SW	5-13
TGM3-10	5-13
TGM4-	5-13
TGM632-10	5-13
TGU-1	5-10
TH-	4-108
TH-1	4-107
TH-3	4-107
THA-	4-100
THC-	4-101
THCA-1	4-102
THCC-1	4-57
THCS-1F	1-128
THCS-2	1-128
THD-	4-101
THE-	4-100
THEL-41	4-103
THF-1	4-103
THFA-1	4-103
THG-	4-102
THH-	4-102
THI-4	4-101
THJ-15	4-102
THJA-1	4-105
THL-4.8	4-101
THM-1	4-105
THMA-1	4-109
THMB-	6-68
THMC-1	6-68
THMK-1	6-68
THN-1	4-101

Part No.	Page
THP-1	4-65
THR5-8	8-14
THR13-6	8-13
THR14-7	8-13
THR16-	8-14
THR1A3-2.4	8-13
THU-	4-109
THV-	4-97
THV-11	4-96
THV-14	4-98
THV-15	4-98
THV-16	4-98
THV-17	4-98
THVA-1	4-95
THVB-1	4-95
THVC-1	4-39
THVD-1	4-97
THW-	4-98
TL-	4-105
TM-	4-108
TM-4	4-108
TNF-1	9-12
TNF-2	9-11
TNF-3	9-12
TNF-5	9-11
TNF-6	9-11
TNF-7	9-11
TNF-9	9-12
TNF-15	9-12
TNF-19	9-12
TNF-40	9-12
TNF-41	9-11
TNF-44	9-11
TNF-46	9-12
TNF-47	9-12
TNFF-1	9-11
TNFF-2	9-11
TNFF-3	9-11
TNFF-4	9-11
TO-	6-73
TO-05	6-29
TO-05-1	6-30
TO-3APF	6-32
TO-3PCV	6-74
TO-3PCV-C	6-74
TO-5	6-31
TO-18	6-30
TO-92	6-30
TO-220CV	6-74
TO-220ST	10-43
TOA-92-9.5	6-30
TP-	1-116
TP-5S	1-116
TP-5SM	1-116
TP-6S	1-116
TP-6ST	1-123
TP-6ST-1	1-123
TP-7-4	1-116
TP-8L	1-117
TP-9-4	1-116

Part No.	Page
TP-10BA	1-122
TP-10.8	1-116
TP-11.2	1-116
TP-25ST	1-122
TP-32.7L	1-116
TP-XXS	1-116
TP-XXSUS	1-122
TP2-	1-115
TP2-XXS	1-115
TP2L-4	1-114
TP2.5-	1-115
TP2.5-2-6	1-115
TP2.5-6L	1-115
TP2.6-	1-115
TP3-2.5-6	1-116
TP3-10.4	1-117
TP3-45LST	1-122
TP3-45ST	1-122
TP3-6	1-116
TP3-7.5	1-117
TP3-9ST	1-123
TP3-XXL	1-117
TP4-	1-118
TP4-XXL	1-118
TP4-XXR	1-118
TP5-60	1-118
TP440-	1-118
TP632-	1-119
TP632-17	1-119
TP632-19.05BA	1-123
TP632-25.4BA	1-123
TP632-M310	1-119
TP632-XXL	1-119
TP632-XXS	1-119
TP832-	1-119
TP832-9.5	1-119
TPA-4	1-114
TPB3-20NI	1-122
TPB3-40NI	1-122
TPD-19	1-117
TPIM2.5-3-42	1-123
TPIM4-90	1-124
TPR4-15	1-117
TPS-	1-116
TPS3-7ST	1-123
TPS4-	1-117
TPS4-XXL	1-117
TPS44-11	1-117
TPS632-6	1-117
TR-	6-38
TR-	6-39
TR-3	6-43
TR-4	6-32
TR-6	6-32
TR-9	6-42
TR-12	6-43
TR-18	6-40
TR-19	6-43
TR-24	6-40
TR-25	6-40

Part No.	Page
TR-31	6-43
TR-32	6-44
TR-33	6-44
TR-37	6-40
TR-41	6-44
TR-42	6-44
TR-43	6-44
TR-46	6-48
TR-50	6-43
TR3-	6-43
TR3-11-1	6-43
TRA-1	6-48
TRAB-1	6-48
TRAC-	6-48
TRAC-9	6-48
TRAC-10.8L	6-48
TRAD-0.9	6-48
TRAE-2.35	6-48
TRB-	6-31
TRB-3	6-68
TRB-4	6-68
TRB-12	6-67
TRB-21	6-31
TRB-22	6-31
TRC-1	6-32
TRCMP-1	10-40
TRCMP-2	10-40
TRCMP-3	10-40
TRCMP-4	10-40
TRCMP-5	10-40
TRCMP-6	10-40
TRD-1	6-41
TRE-1-1	6-46
TRF-1	6-41
TRG-	6-40
TRGB-1	6-44
TRGC-4.5	6-44
TRGL-1	6-41
TRGS-9	6-40
TRGV-	6-40
TRK-	6-9
TRK-8	6-10
TRK-9	6-10
TRK-10	6-10
TRK-12	6-10
TRK-16F	6-8
TRK-17AF	6-8
TRK-22	6-10
TRK-35	6-8
TRK-40	6-10
TRMC-1	10-42
TRMC-2	10-42
TRMC-5	10-42
TRMC-6	10-42
TRMC-7	10-41
TRMC-8	10-43
TRMC-9	10-42
TRMC-10	10-43
TRMC-11	10-44
TRMC-12	10-44

Part No.	Page
TRMC-17	10-42
TRMC-20	10-41
TRMC-23	10-41
TRMC-26	10-41
TRMC-30	10-42
TRMC-34	10-41
TRMC-35	10-41
TRMC-40	10-41
TRMC-49	10-41
TRMC-53	10-44
TRMC-59	10-42
TRMC-61	10-42
TRMC-68	10-43
TRMC-76	10-41
TRMC-77	10-41
TRMC-78	10-41
TRMC-121	10-43
TRMC-122	10-42
TRMC-123	10-42
TRMC-124	10-42
TRMC-126	10-43
TRMC-135	10-43
TRMC-141	10-42
TRMC-154	10-41
TRMH-20	7-93
TRO-7.5	6-40
TRS-	6-41
TRU-6.5	6-41
TRW-	6-42
TRW3-	6-42
TRW3-4	6-43
TRW3-5	6-43
TRWA-1	6-42
TRWF-	6-42
TSC-	6-81
TSC-3	6-84
TSC-4	6-82
TSC-5	6-82
TSC-6	6-82
TSC-7	6-85
TSC-9	6-83
TSC-18	6-84
TSC-20	6-83
TSC-22	6-80
TSC-23	6-80
TSC-24	6-85
TSC-25	6-82
TSC-26	6-82
TSC-27	6-85
TSC-28	6-82
TSC-29	7-43
TSC-36	6-84
TSC-38	6-84
TSC-40	6-82
TSC-42	6-83
TSC-45	6-82
TSC-49	6-82
TW-	6-17
TW-	6-18
TW-	6-19

Part No.	Page
TW-	6-20
TW-	6-22
TW-	6-24
TW-125	6-21
TW-133	6-21
TW-147	6-21
TW-178	6-22
TW-180	6-23
TW-190	6-24
TW-191	6-24
TW-210	6-22
TW-236	6-23
TW-241	6-21
TW-277	6-23
TW-290	6-24
TW-297	6-21
TW-298	6-21
TW-299	6-21
TW-312	6-23
TWC-	6-22
TWC-1	6-25
TWC-2	6-25
TWC-4	6-26
TWC-8	6-25
TWC-14	6-26
TWC-15	6-25
TWC-17	6-27
TWC-19	6-25
TWU-	6-26
U-	6-28
UB-3S	1-76
UB-4	1-76
UB-6	1-76
UB-6D	1-76
UB-6E	1-75
UB-14D	1-76
UB-XXA	1-75
UBD-1	1-75
UBD-2	1-75
UCBS-	1-44
UCBS-5A	1-44
UCBSL-9	1-45
UCBSL-10	1-45
ULCB-	1-85
ULCB-9S	1-85
ULCB-15	1-85
ULCB-38	1-85
ULCBA-5	1-82
ULCBA-7.8	1-83
ULCBB-7.9	1-84
ULCBB-12.7L	1-84
ULCBM4-9.5	1-81
ULCC-	1-81
ULCD-7.8	1-80
ULCE-9	1-83
ULCF-	1-76
ULCG-1	8-39
ULCG-2	8-39
ULCH-1	1-80
ULCH-2	1-80

Part No.	Page
ULCH-2S	1-80
ULCI-11	1-79
ULCIJ-4	1-80
ULCK-6.4	1-79
ULCKA-15.6	1-89
ULCN-1	1-134
ULCN-3	1-134
ULCN1.7-2.4	1-134
ULCN2.2-1.2	1-134
ULCN2.5-	1-134
ULCN2.5-1.2	1-135
ULCN3.4-	1-134
ULCN6.3-1.6	1-134
ULCN6.6-1.2	1-135
ULCN6.6-1.6	1-135
ULCNA2.5-1.8	1-136
ULCNA2.5-1.8S	1-136
ULCNA2.5-4.3	1-136
ULCNA4-1.8	1-136
ULCND1.5-1.1	1-137
ULCND2.5-1.6	1-138
ULCNF2.5-1.2	1-136
ULCO2.1-2	1-135
ULCO2.4-	1-135
ULCO2.4A-3.1	1-135
ULCO2.5-	1-135
ULCO3.8-1.6	1-135
ULCO3.8-1.6S	1-135
ULCO6.6-	1-136
ULCO6.6-2.6	1-135
ULCO6.6-3.1S	1-136
ULCOA5-1.6A	1-137
ULCOB-1	1-136
ULCOB-2	1-136
ULCOB3.3-2.3	1-136
ULCOB3.4-1.6	1-137
ULCOB6-1.6	1-136
ULCOB6-2.3	1-136
ULCOC-1	1-137
ULCOC-2	1-137
ULCOC-2L	1-137
ULCOC-4	1-138
ULCOC-7L	1-137
ULCOC-8	1-138
ULCOC-9	1-137
ULCOC-12	1-139
ULCOC-14	1-137
ULCOC2.4-2.6	1-139
ULCOD-1	1-138
ULCOD1.5-1.6	1-138
ULCOE-3	1-138
ULCOE-4	1-138
ULCOF-2F	1-142
ULCOF-6F	1-141
ULCOF-6LF	1-141
ULCOF-6SF	1-141
ULCOF-7F	1-141
ULCOF-7LF	1-141
ULCOF-9F	1-142
ULCOF-9MF	1-142

Part No.	Page
ULCOF-10F	1-141
ULCOF-14LF	1-142
ULCOF-17F	1-141
ULCOF-19F	1-142
ULCOF-20F	1-142
ULCOF-21LF	1-142
ULCOG2.5-1.6	1-135
ULCOG6.3-1.6	1-135
ULCOI-3F	1-142
ULCOI-5F	1-143
ULCOI-XXF	1-142
ULCOJ-1	1-135
ULCOM-1	1-139
ULCON-1F	1-143
ULCON-3F	1-143
ULCSA-8	1-81
ULCSA-8S	1-81
ULCSA-16	1-81
ULCSA-16S	1-81
ULCSA-28.8S	1-82
ULCSD-5	1-82
ULCSE-	1-83
ULCSE-7	1-83
ULCSF-6.6	1-82
ULCW2.5-1.6	1-135
ULCY-1	1-137
ULCY-2	1-137
ULCY3.9-1.6	1-137
ULCZ-1.6	7-46
ULD-1	1-139
ULF-1(BU)F	1-144
ULF-3.6(BU)F	1-144
UNCV-	1-144
UPA-	6-29
UPC-	6-27
UPD-1	6-25
USB3C-	7-7
USBC-	7-1
USBC-1	7-2
USBC-3	7-2
USBC-7	7-2
USBC-9	7-3
USBC-10	7-3
USBC-13	7-3
USBC-15	7-2
USBC-16	7-3
USBC-17	7-4
USBC-21	7-7
USBC-25	7-3
USBC-30	7-4
USBC-31	7-3
USBC-34	7-2
USBC-42	7-2
USBH-1	7-8
UT-	6-23
UT-2	6-24
UT-4	6-24
UT-7	6-24
UT-8	6-24
UT-11	6-24

Part No.	Page
UT-14	6-28
UT-19	6-24
V-	6-77
VC	6-76
VCBA-14.4F	1-40
VCBS-	1-39
VCBSL-	1-39
VCO	5-56
VCP	6-76
VGAB-	7-28
VGAC-1	7-27
VRCV-1	6-46
VRCVA-	6-80
W2LK-1	4-53
WAK-1	4-120
WAL-	4-120
WAS-1	4-67
WBH-	1-68
WBHB-1.8	1-68
WBHC-6.4	1-67
WC-	4-25
WC-1	4-24
WC-4	4-27
WCA-1	4-20
WCC-	4-20
WCC-5	4-21
WCC-6	4-21
WCC-7	4-21
WCC-9	4-21
WCD-	4-19
WCL-	4-26
WCL-1	4-25
WCL-2	4-118
WCL-3	4-118
WCL-11	4-25
WCL-12	4-25
WCL-13	4-25
WCL-15	4-25
WCL-23	4-25
WCL-29	4-25
WCL-30	4-24
WCLA-1	4-27
WCLB-1	4-69
WCLL-1	4-29
WCM-	4-30
WCS-	4-28
WCS-3	4-29
WCS-4	4-29
WCT-	4-25
WDF-	4-19
WDT-20	4-15
WKA-1	4-73
WKL-10	4-103
WKM-	4-73
WL-	4-78
WL3-XXH	10-5
WL3-XXT	10-4
WL4-XXH	10-5
WL4-XXT	10-4
WL5-70H	10-5

Part No.	Page
WL5-70T	10-4
WL6-78H	10-5
WL6-78T	10-4
WLB-1	4-53
WLC-1	10-5
WLCF-	1-76
WLD-XXH	10-5
WLD-XXT	10-5
WLF-	4-52
WLG-1	4-33
WLL-	4-32
WLL-8	4-35
WLL-9	4-33
WLL-10	4-33
WLL-11	4-35
WLL-12	4-35
WLL-17	4-33
WLL-18	4-33
WLL-26	4-35
WLL-27	4-34
WLL-28	4-35
WLL-29	4-35
WLL-32	4-34
WLL-33	4-34
WLL-35	4-35
WLLC-1	6-69
WLLD-14	4-34
WLLT-	4-39
WLLT-1	4-38
WLM-1	4-52
WLN-	4-52
WLO-	4-75
WLT-	4-53
WLU-	4-33
WMEA-1	7-92
WMEZ-	7-92
WPBT-1	6-61
WPEG-	4-71
WPEM-	4-70
WRA-	4-24
WS	6-52
WS	6-53
WSA6-	6-59
WSB-	4-27
WSBC-1	4-73
WSBH-	4-59
WSC-1	6-60
WSF-3	6-26
WSG-1	6-60
WSH-1	6-59
WSK-1	4-20
WSQ4-2	6-61
WSR9.1-8.6-1	6-59
WSRA3.2-1	6-52
WSS-1	4-27
WSS-2	4-67
WSSA-1	4-65
WSU-	6-60
WSUA-	6-58
WSUB-	6-57

Part No.	Page
WSUC-	6-59
WSW8-3.4-0.5	6-57
WT-	4-31
WT-11	4-38
WTC-	4-38
WTL-	4-103
WUCD-36	4-64
WUCD-100	4-66
WUCDF-100	4-66
WUD-1	4-39
X	
XLR-	7-14
Y	
YES-	1-69
YJ-	5-45
YJ-98X	5-48
YJ-123	5-47
YJ-R	5-46
YJ-R150	5-45
YJ-R151	5-47
YJ-R191	5-47
YJ-R200	5-45
YJ-R231	5-47
YJ-R250	5-45
YJ-XXX	5-48
YJECL-	4-111
YJHH-4.8	5-55
工具	5-85
熱縮套管	5-60
黏貼標誌貼紙	5-84
織布管	5-60

MS CERT

Certificate Of Registration
QUALITY MANAGEMENT SYSTEM

This is to certify that the Quality Management System of
KANG YANG HARDWARE ENTERPRISES CO., LTD.
Address: No. 117, Huanhe Street, Xizhi District, New Taipei City, 22154, Taiwan (R.O.C.)
has been assessed and found to comply with the requirements of:

ISO 9001:2015
(Quality Management System)

Scope of Certification:
The Manufacturing of Plastic Injection Parts for Electronic Products
Sector Code: 14
Certificate Number: **TW/QMS/00794/18112**

Issue no.: 01
Date of approval: 02.11.2023 Valid until: 02.11.2026
Revision no. nil
Initial Certification Date: 02.11.2023

Authorized by:

MS CERT

MS CERT (Taiwan) Co., Ltd. (CERTIFICATION BODY) is a 100% Chinese-owned and controlled organization, whose activities are conducted under the supervision of the Ministry of Economic Affairs, Executive Yuan, Taiwan. The validity of this certificate can be verified at <http://www.ms-cert.com.tw> and www.iso.org/iso/80000 and this certificate is valid only if the signed functions block is signed by a person designated.

nqa

This is to certify that the Quality Management System of
KANG YANG Hardware Enterprise Co., Ltd.
No. 11-5 Lane 338, Sec. 2, Feng-Hsing Road, Tainzi District, Taichung City
42744, TAIWAN, CHINA
is applicable to
The manufacturing of plastic injection parts for electronic products
Has been assessed and registered by NQA against the provisions of
BS EN ISO 9001 : 2015

This registration is subject to the company maintaining a quality management system, to the above standard, which will be monitored by NQA.

Certificate No: 123088
Issue Date: 07 November 2023
Valid Until: 31 October 2026
E-Code: 14

Managing Director:

Authorized by:

IAF

CERTIFICATE

DZCC

Hereby Grants To:

KANG CHE COMPUTER COMPONENTS (WU JIANG) CO., LTD.
Organization Credit Code: 91320507244413033
Registered Address: Huagang Road, Songling Town, Wujiang District, Suzhou City, Jiangsu Province, P.R.China
Business Address: No.877, Huagang Road, Songling Town, Wujiang District, Suzhou City, Jiangsu Province, P.R.China

Has been assessed and found to be in accordance with the requirements of standard detailed below:
GB/T 19001-2016/ISO 9001:2015

Scope:
The Manufacture of Plastic Injection Parts for Electronic Products.

LSP CODE: 15
Certificate No.: QZ/CN/23082892
Certificate Issue Date: 2023-10-31
Registration Expiration Date: 2026-10-16

The certified organization must pass surveillance audit to ensure the validity of the certificate.

Authorized by:

IAF IAS ACCREDITED

MSCB-235

Dazhong (Shanghai) Certification Co., Ltd.
Room 210-212, Building 1 - Commercial Office Building, Phase 1, Nanshi Binhai Garden, No. 2, Haining Rd, Nanshi District, Shanghai City, Shanghai Province, P.R.China
TEL: +86-20-34284270
Check the validity of this certificate on the official website of Certification and Accreditation Administration of People's Republic of China (www.cnca.gov.cn) or www.dzcc.com.

MS CERT

Certificate Of Registration
ENVIRONMENTAL MANAGEMENT SYSTEM

This is to certify that the Environmental Management System of
KANG YANG HARDWARE ENTERPRISES CO., LTD.
Address: No. 117, Huanhe Street, Xizhi District, New Taipei City, 22154, Taiwan (R.O.C.)
has been assessed and found to comply with the requirements of:

ISO 14001:2015
(Environmental Management System)

Scope of Certification:
The Manufacturing of Plastic Injection Parts for Electronic Products
Sector Code: 14
Certificate Number: **TW/EMS/00801/18113**

Issue no.: 01
Date of approval: 02.11.2023 Valid until: 02.11.2026
Revision no. nil
Original Certification Date: 02.11.2023

Authorized by:

MS CERT

MS CERT (Taiwan) Co., Ltd. (CERTIFICATION BODY) is a 100% Chinese-owned and controlled organization, whose activities are conducted under the supervision of the Ministry of Economic Affairs, Executive Yuan, Taiwan. The validity of this certificate can be verified at <http://www.ms-cert.com.tw> and www.iso.org/iso/80000 and this certificate is valid only if the signed functions block is signed by a person designated.

MS CERT

Certificate Of Registration
ENVIRONMENTAL MANAGEMENT SYSTEM

This is to certify that the Environmental Management System of
KANG YANG HARDWARE ENTERPRISES CO., LTD.
Address: No. 11-5 Lane 338, Sec. 2, Feng-Hsing Road, Tainzi District, Taichung City 42744, Taiwan, China
has been assessed and found to comply with the requirements of:

ISO 14001:2015
(Environmental Management System)

Scope of Certification:
The Manufacturing of Plastic Injection Parts for Electronic Products
Sector Code: 14
Certificate Number: **TW/EMS/00802/18114**

Issue no.: 01
Date of approval: 02.11.2023 Valid until: 02.11.2026
Revision no. nil
Original Certification Date: 02.11.2023

Authorized by:

MS CERT

MS CERT (Taiwan) Co., Ltd. (CERTIFICATION BODY) is a 100% Chinese-owned and controlled organization, whose activities are conducted under the supervision of the Ministry of Economic Affairs, Executive Yuan, Taiwan. The validity of this certificate can be verified at <http://www.ms-cert.com.tw> and www.iso.org/iso/80000 and this certificate is valid only if the signed functions block is signed by a person designated.

CERTIFICATE

DZCC

Hereby Grants To:

KANG CHE COMPUTER COMPONENTS (WU JIANG) CO., LTD.
Organization Credit Code: 91320507244413033
Registered Address: Huagang Road, Songling Town, Wujiang District, Suzhou City, Jiangsu Province, P.R.China
Business Address: No.877, Huagang Road, Songling Town, Wujiang District, Suzhou City, Jiangsu Province, P.R.China

Has been assessed and found to be in accordance with the requirements of standard detailed below:
GB/T 24001-2016/ISO 14001:2015

Scope:
The Manufacture of Plastic Injection Parts for Electronic Products and Management of Related Environmental Aspects.

LSP CODE: 11
Certificate No.: QZ/CN/23082892
Certificate Issue Date: 2023-10-31
Registration Expiration Date: 2026-10-16

The certified organization must pass surveillance audit to ensure the validity of the certificate.

Authorized by:

IAF IAS ACCREDITED

MSCB-235

Dazhong (Shanghai) Certification Co., Ltd.
Room 210-212, Building 1 - Commercial Office Building, Phase 1, Nanshi Binhai Garden, No. 2, Haining Rd, Nanshi District, Shanghai City, Shanghai Province, P.R.China
TEL: +86-20-34284270
Check the validity of this certificate on the official website of Certification and Accreditation Administration of People's Republic of China (www.cnca.gov.cn) or www.dzcc.com.

CERTIFICATE

ARES

The Governing Board of
ARES International Certification Co., Ltd.
Hereby Grants To:

KANG YANG HARDWARE ENTERPRISES CO., LTD.
NO. 117, HUANHE STREET, XIZHI DISTRICT, NEW TAIPEI CITY, 22154, TAIWAN

Has been assessed and found to be in accordance with the requirements of standard detailed below:
IECQ-QC80000 : 2017

Scope:
The Manufacturing of Plastic Injection Parts for Electronic Products

Certificate No.: **ARE/TW/20230495PH**
Certificate Issue Date: 2023-12-11
Registration Expiration Date: 2026-12-30

The time interval between each surveillance audit and the first on-site audit shall not exceed 12 months, and the registration must obtain "surveillance audit approval notification" issued by ARE to ensure the validity of the certificate.

Authorized by:

ARES International Certification Co., Ltd.
No.12-2, Ln. 197, Ningyue Rd., Anping Dist., Taichung City 708, Taiwan
TEL: +6-209 9696 (Ext. Lines) FAX: +6-209 9667
www.ares-reg.com

CERTIFICATE

ARES

The Governing Board of
ARES International Certification Co., Ltd.
Hereby Grants To:

KANG YANG HARDWARE ENTERPRISES CO., LTD.
NO. 11-5, LANE 338, SEC. 2, FENG-HSING ROAD, TAINZI DISTRICT, TAICHUNG CITY, 42744, TAIWAN

Has been assessed and found to be in accordance with the requirements of standard detailed below:
IECQ-QC80000 : 2017

Scope:
The Manufacturing of Plastic Injection Parts for Electronic Products

Certificate No.: **ARE/TW/20230495PH**
Certificate Issue Date: 2023-12-11
Registration Expiration Date: 2026-12-30

The time interval between each surveillance audit and the first on-site audit shall not exceed 12 months, and the registration must obtain "surveillance audit approval notification" issued by ARE to ensure the validity of the certificate.

Authorized by:

ARES International Certification Co., Ltd.
No.12-2, Ln. 197, Ningyue Rd., Anping Dist., Taichung City 708, Taiwan
TEL: +6-209 9696 (Ext. Lines) FAX: +6-209 9667
www.ares-reg.com

CERTIFICATE

DZCC

The Governing Board of

KANG CHE COMPUTER COMPONENTS (WU JIANG) CO., LTD.
Organization Credit Code: 91320507244413033
Registered Address: Huagang Road, Songling Town, Wujiang District, Suzhou City, Jiangsu Province, P.R.China
Business Address: No.877, Huagang Road, Songling Town, Wujiang District, Suzhou City, Jiangsu Province, P.R.China

Has been assessed and found to be in accordance with the requirements of standard detailed below:
QC80000:2017

Scope:
The Manufacture of Plastic Injection Parts for Electronic Products.

Certificate No.: **QZ/CN/231004PH**
Certificate Issue Date: 2023-11-09
Registration Expiration Date: 2026-11-08

The time interval between each surveillance audit and the first on-site audit shall not exceed 12 months, and the registration must obtain "surveillance audit approval notification" issued by DZCC to ensure the validity of the certificate.

Authorized by:

IAF IAS ACCREDITED

MSCB-235

Dazhong (Shanghai) Certification Co., Ltd.
Room 210-212, Building 1 - Commercial Office Building, Phase 1, Nanshi Binhai Garden, No. 2, Haining Rd, Nanshi District, Shanghai City, Shanghai Province, P.R.China
TEL: +86-20-34284270
Check the validity of this certificate on the official website of Certification and Accreditation Administration of People's Republic of China (www.cnca.gov.cn) or www.dzcc.com.



台北總公司 Taipei Headquarters

221014 新北市汐止區環河街187號
No.187, Huanhe St., Xizhi Dist.,
New Taipei City, 221014
TEL : +886-2-26921498 FAX : +886-2-26922498
E-mail : kangyang@kangyang.com.tw

中國東莞廠 Dong Guan Factory, China

523878 廣東省東莞市長安鎮上角社區紅棉路2號
No. 2, Hong Mian Rd., Shang Jiao Management Dist.,
Chang An Town, Dong Guan City,
Guang Dong Prov., 523878, China
TEL : +86-769-85305187 FAX : +86-769-85411815
E-mail : kysales@dg-kangyang.com

中國蘇州廠 Suzhou Factory, China

215200 江蘇省蘇州市吳江區松陵鎮花港路877號
No. 877, Hua Gang Rd., Song Ling Town, Wujiang Dist.,
Suzhou City, Jiang Su Prov., 215200, China
TEL : +86-512-80670100 FAX : +86-512-63434598~9
E-mail : kywj@kangyang.net.cn

泰國廠 Thailand Factory

589 Moo 4, Phraeksa Sub-District,
Mueang Samut Prakan District,
Samut Prakan, 10280 Thailand
TEL : +66-2-323-0588
E-mail : service@th.kangyang.com

越南廠 Vietnam Factory

Lot CN5-1, Yen Phong Industrial Park Extension,
Yen Trung Commune, Yen Phong Dist.,
Bac Ninh Prov., Vietnam
TEL : +84-222-222-0598
E-mail : service@vn.kangyang.com

美國 USA

Kang Yang International
TEL : +1 847-258-3339
E-mail : solutions@kangyang-usa.com

荷蘭 The Netherlands

Kang Yang Europe B.V.
TEL : +31 (0)345 65 1937
E-mail : info@kangyang-europe.com

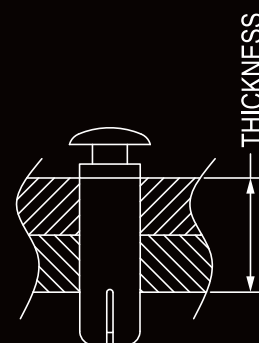
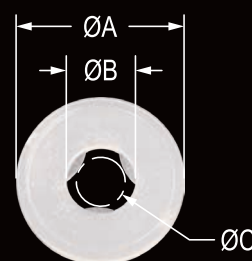
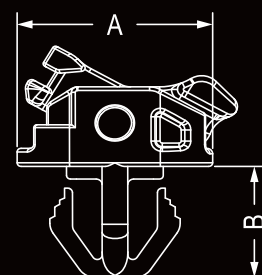
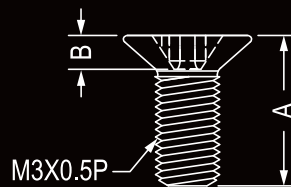
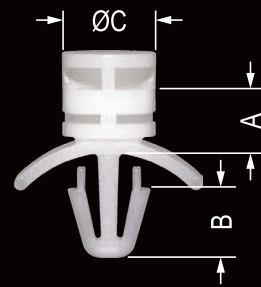

www.kangyang.com.tw

